

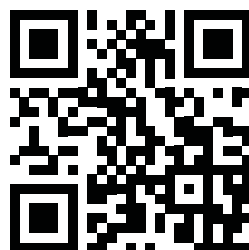

Hahn Einzelteilkatalog

für Kunststoff- und Metalltüren

- F** Catalogue Hahn de pièces détachées pour portes métalliques et en PVC
- GB** Hahn spare parts catalogue for metal doors and PVC-U doors

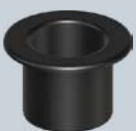
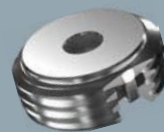
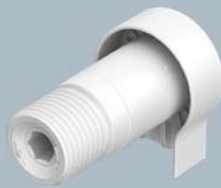





















Fixation Fastening elements



Anker-Schraube · Vis d'ancrage directe · Anchor screw

Ausführung Version Variation	Art.-Nr. No. d'article Item number	VE für UE par PU for*	Ausführung Version Variation	Art.-Nr. No. d'article Item number	VE für UE par PU for*
 37,5 mm Stahl · Acier · Steel 19,5 mm Nutzlänge Longueur utile Effective length	VP02A0012	⊕ 1	 37,5 mm Niro · Inox Stainless steel 19,5 mm Nutzlänge Longueur utile Effective length	VP02A0013	⊕ 1
	VP03A0012	⊕ 1		VP03A0013	⊕ 1
	VP02B0012	⊕ 24		VP02B0013	⊕ 24
	VP03C0012	⊕ 18		VP03C0013	⊕ 18
 48 mm Stahl · Acier · Steel 30 mm Nutzlänge Longueur utile Effective length	VP02A0014	⊕ 1	 48 mm Niro · Inox Stainless steel 30 mm Nutzlänge Longueur utile Effective length	VP02A0015	⊕ 1
	VP03A0014	⊕ 1		VP03A0015	⊕ 1
	VP02B0014	⊕ 24		VP02B0015	⊕ 24
	VP03C0014	⊕ 18		VP03C0015	⊕ 18
 58 mm Stahl · Acier · Steel 40 mm Nutzlänge Longueur utile Effective length	VP02A0016	⊕ 1	 58 mm Niro · Inox Stainless steel 40 mm Nutzlänge Longueur utile Effective length	VP02A0017	⊕ 1
	VP03A0016	⊕ 1		VP03A0017	⊕ 1
	VP02B0016	⊕ 24		VP02B0017	⊕ 24
	VP03C0016	⊕ 18		VP03C0017	⊕ 18
 74 mm Stahl · Acier · Steel 56 mm Nutzlänge Longueur utile Effective length	VP02A0019	⊕ 1	 74 mm Niro · Inox Stainless steel 56 mm Nutzlänge Longueur utile Effective length	VP02A0020	⊕ 1
	VP03A0019	⊕ 1		VP03A0020	⊕ 1
	VP02B0019	⊕ 24		VP02B0020	⊕ 24
	VP03C0019	⊕ 18		VP03C0020	⊕ 18
 58 mm Für Stahlprofile Pour profils en acier For steel profiles 40 mm Nutzlänge Longueur utile Effective length	VP02A0018	⊕ 1			
	VP03A0018	⊕ 1			
	VP02B0018	⊕ 24			
	VP03C0018	⊕ 18			

Schraub-Anker · Vis d'ancrage · Screw anchor

 36 mm Stahl · Acier · Steel 27 mm Nutzlänge Longueur utile Effective length	VP02A0003	⊕ 1	 36 mm Niro · Inox Stainless steel 27 mm Nutzlänge Longueur utile Effective length	VP02A0004	⊕ 1
	VP03A0003	⊕ 1		VP03A0004	⊕ 1
	VP02B0003	⊕ 24		VP02B0004	⊕ 24
	VP03C0003	⊕ 18		VP03C0004	⊕ 18
 41 mm Stahl · Acier · Steel 32 mm Nutzlänge Longueur utile Effective length	VP02A0005	⊕ 1	 41 mm Niro · Inox Stainless steel 32 mm Nutzlänge Longueur utile Effective length	VP02A0006	⊕ 1
	VP03A0005	⊕ 1		VP03A0006	⊕ 1
	VP02B0005	⊕ 24		VP02B0006	⊕ 24
	VP03C0005	⊕ 18		VP03C0006	⊕ 18
 51 mm Stahl · Acier · Steel 42 mm Nutzlänge Longueur utile Effective length	VP02A0007	⊕ 1	 51 mm Niro · Inox Stainless steel 42 mm Nutzlänge Longueur utile Effective length	VP02A0008	⊕ 1
	VP03A0007	⊕ 1		VP03A0008	⊕ 1
	VP02B0007	⊕ 24		VP02B0008	⊕ 24
	VP03C0007	⊕ 18		VP03C0008	⊕ 18
 55 mm Stahl · Acier · Steel 46 mm Nutzlänge Longueur utile Effective length	VP02A0010	⊕ 1	 55 mm Niro · Inox Stainless steel 46 mm Nutzlänge Longueur utile Effective length	VP02A0011	⊕ 1
	VP03A0010	⊕ 1		VP03A0011	⊕ 1
	VP02B0010	⊕ 24		VP02B0011	⊕ 24
	VP03C0010	⊕ 18		VP03C0011	⊕ 18
 51 mm Für Stahlprofile Pour profils en acier For steel profiles 42 mm Nutzlänge Longueur utile Effective length	VP02A0009	⊕ 1			
	VP03A0009	⊕ 1			
	VP02B0009	⊕ 24			
	VP03C0009	⊕ 18			

* VE für · UE par · PU for = Verpackungseinheit für Band/Bänder · Unité d'emballage pour paumelle/paumelles · Packing unit for hinge/hinges

Fixation
Fastening elements

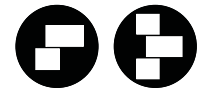

Befestigungsplatte · Contre-plaque de fixation · Mounting plate

Ausführung Version Variation	Art.-Nr. No. d'article Item number	VE für UE par PU for*	Ausführung Version Variation	Art.-Nr. No. d'article Item number	VE für UE par PU for*
15 15 mm	VP02A0000	⊕ 1	21 21 mm	VP02A0001	⊕ 1
	VP03A0000	⊕ 1		VP03A0001	⊕ 1
	VP02B0000	⊕ 24		VP02B0001	⊕ 24
	VP03C0000	⊕ 18		VP03C0001	⊕ 18

*VE für · UE par · PU for = Verpackungseinheit für Band/Bänder · Unité d'emballage pour paumelle/paumelles · Packing unit for hinge/hinges

Spreizbuchsenbefestigung · Fixation par douilles à expansion · Expansion bushing mounting

Ausführung Version Variation	Art.-Nr. No. d'article Item number
Spreizbuchsenset komplett Kit douilles à expansion Split bushing set, complete	2 Stück 2 pièces M700B1059 2 pièces
Spreizbuchsenset komplett Kit douilles à expansion Split bushing set, complete	4 Stück 2 pièces M700B1060 4 pièces
Spreizbuchsenset komplett Kit douilles à expansion Split bushing set, complete	6 Stück 2 pièces M700B1061 6 pièces

Mindestwandstärke der Profile von 2,2 mm erforderlich.
Gewicht bei 2000 x 1000 mm großen Flügeln maximal
80 kg. Nur verwendbar mit Kegelbuchsen. Werkseitige
Montage erforderlich. Bohrlehren und Ausführungen für
Wandstärken über 3 mm auf Anfrage.

Épaisseur minimum des parois du profil de 2,2 mm nécessaire.
Poids max. admissible de 80 kg pour des dimensions de vantaux
de 2000 x 1000 mm. Utilisables uniquement avec des douilles
coniques. Montage en usine nécessaire. Gabarits de perçage et
versions spécifiques pour parois de profils supérieure à 3 mm sur
demande.

Sections must have a minimum wall thickness of 2.2 mm.
Maximum weight is 80 kg with 2000 x 1000 mm door leaf. May
only be used with tapered bushings. Factory assembly necessary.
Drilling jigs and designs for walls thicker than 3 mm available on
request.







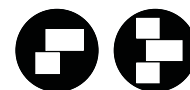





Modes de fixation
Fixing methods











Anker-Schraube · Vis d'ancrage directe · Anchor screw

Ausführung Version Variation	Art.-Nr. No. d'article Item number	*	Ausführung Version Variation	Art.-Nr. No. d'article Item number	*
 37,5 mm Stahl · Acier · Steel 19,5 mm Nutzlänge Longueur utile Effective length	A900E0014	K	 37,5 mm Niro · Inox Stainless steel 19,5 mm Nutzlänge Longueur utile Effective length	A900E0046	L
 48 mm Stahl · Acier · Steel 30 mm Nutzlänge Longueur utile Effective length	A900E0007	T	 48 mm Niro · Inox Stainless steel 30 mm Nutzlänge Longueur utile Effective length	A900E0010	V
 58 mm Stahl · Acier · Steel 40 mm Nutzlänge Longueur utile Effective length	A900E0005	W	 58 mm Niro · Inox Stainless steel 40 mm Nutzlänge Longueur utile Effective length	A900E0009	Y
 74 mm Stahl · Acier · Steel 56 mm Nutzlänge Longueur utile Effective length	A900E0008	M	 74 mm Niro · Inox Stainless steel 56 mm Nutzlänge Longueur utile Effective length	A900E0011	N
 58 mm Für Stahlprofile Pour profils en acier For steel profiles 40 mm Nutzlänge Longueur utile Effective length	A900E0012	S			

* Kennbuchstabe in Verbindung mit komplettem Band · Lettre d'identification dans la référence de la paumelle · Code lettering in combination with complete hinge

Befestigungsplatte · Contre-plaque de fixation · Mounting plate

Ausführung Version Variation	 15 15 mm	Art.-Nr. No. d'article Item number	 21 21 mm	Art.-Nr. No. d'article Item number
Für Rahmen- und Flügelbandteil · Pour bras dormant et bras ouvrant For frame hinge part and hinge blade for door		A850A0002		A850A0004
Für Flügelbandteil · Pour bras ouvrant · For hinge blade for door		A850A0002		A850A0004
Für Rahmenbandteil · Pour bras dormant · For frame hinge part		A850A0003		A850A0005

Schraube · Vis · Screw

Ausführung Version Variation	TÜRBAND 4	Verzinkt Galvanisé Galvanised	Art.-Nr. No. d'article Item number	Niro Inox Stainless steel	Art.-Nr. No. d'article Item number
M8 x 25			E1512801		E1514803
M8 x 31			E1512810		E1514806
M8 x 38			E1512802		E1514804
M8 x 49			E1512803		E1514805
M8 x 63			E1512806		—

Ausführung Version Variation	TÜRBAND 4 AT	Art.-Nr. No. d'article Item number
M8 x 28		M900E0006

Einzelteile für Hahn Universalbänder für Metalltüren

Catalogue Hahn de pièces détachées pour portes métalliques · *Hahn spare parts catalogue for metal doors*

SERIE 60 AT		Hahn Serie 60 AT	Neue Ausführung! Ab Oktober 2014 Nouvelle version ! Depuis Octobre 2014 · <i>New version October 2014!</i>	6
SERIE 60 AT		Hahn Serie 60 AT	Alte Ausführung! Bis September 2014 · Ancienne version ! Jusqu'à Septembre 2014 · <i>Old version until September 2014!</i>	7
TÜRBAND 4 AT		Hahn Türband 4 AT	Neue Ausführung! Ab Juni 2020 Nouvelle version ! Depuis Juin 2020 · <i>New version June 2020!</i>	8
TÜRBAND 4		Hahn Türband 4	Alte Ausführung! Bis Mai 2020 Ancienne version ! Jusqu'à Mai 2020 · <i>Old version until May 2020!</i>	10
KLEMMband		Hahn Klemmband		12
ROLLENband AT		Hahn Rollenband AT	Neue Ausführung! Ab Mai 2019 Nouvelle version ! Depuis Mai 2019 · <i>New version Mai 2019!</i>	13
KLEMMband NG		Hahn Klemmband NG		14
ROLLENband NG		Hahn Rollenband NG		16
Rollenband G		Hahn Rollenband G		17
AT-G		Hahn AT-G		18

Einzelteile für Hahn Universalbänder für Kunststofftüren

Catalogue Hahn de pièces détachées pour portes pvc · *Hahn spare parts catalogue for plastic doors*

		Hahn KT-N 6R/KT-V 6R	Neue Ausführung! Ab 2017 Nouvelle version ! Depuis 2017 · <i>New version 2017!</i>	22
		Hahn KT-N 6R/KT-V 6R	Alte Ausführung! Bis 2016 Ancienne version ! Jusqu'à 2016 · <i>Old version until 2016!</i>	23
		Hahn KT-N 6R/KT-V 6R mit KT-FIX	Neue Ausführung! Ab 2017 Nouvelle version ! Depuis 2017 · <i>New version 2017!</i>	24
		Hahn KT-N 6R/KT-V 6R mit KT-FIX	Alte Ausführung! Bis 2016 Ancienne version ! Jusqu'à 2016 · <i>Old version until 2016!</i>	25
		Hahn KT-EN/KT-EV mit KT-FIX	Neue Ausführung! Ab 2017 Nouvelle version ! Depuis 2017 · <i>New version 2017!</i>	26
		Hahn KT-EN/KT-EV mit KT-FIX	Alte Ausführung! Bis 2016 Ancienne version ! Jusqu'à 2016 · <i>Old version until 2016!</i>	27
		Hahn KT-SN/KT-SV	Neue Ausführung! Ab 2017 Nouvelle version ! Depuis 2017 · <i>New version 2017!</i>	28
		Hahn KT-SN/KT-SV	Alte Ausführung! Bis 2016 Ancienne version ! Jusqu'à 2016 · <i>Old version until 2016!</i>	29
		Hahn KT-R		30
		Hahn KT-G		32
		Hahn KT-RF		33
		Hahn KT-RN		34
		Hahn KT-B 6R	Neue Ausführung! Ab Mai 2019 Nouvelle version ! Depuis Mai 2019 · <i>New version Mai 2019!</i>	35
		Hahn KT-B mit KT-FIX	Neue Ausführung! Ab 2017 Nouvelle version ! Depuis 2017 · <i>New version 2017!</i>	36
		Hahn KT-B	Alte Ausführung! Bis 2016 Ancienne version ! Jusqu'à 2016 · <i>Old version until 2016!</i>	37
		Hahn KT-B	Neue Ausführung! Ab 2008 Nouvelle version ! Depuis 2008 · <i>New version 2008!</i>	37
		Hahn KT-RKN		38
		Hahn KT-RKV		40



HAHN SERIE 60 AT – NEUE AUSFÜHRUNG! AB OKTOBER 2014

SERIE 60 AT

Nouvelle version ! Depuis Octobre 2014
New version October 2014!



Rahmenbandteil
Bras dormant
Frame hinge part
Art.-Nr. auf Anfrage
No. d'article sur demande
Item no. on request



Flügelbandteil
Bras ouvrant
Door hinge blade
Art.-Nr. auf Anfrage
No. d'article sur demande
Item no. on request



Abdeckstück
Rahmenbandteil
Cache-vis bras dormant
Cover strip frame hinge part
Art.-Nr. auf Anfrage
No. d'article sur demande
Item no. on request



Abdeckstück Flügelbandteil
Cache-vis bras ouvrant
Cover strip door hinge blade
Art.-Nr. auf Anfrage
No. d'article sur demande
Item no. on request



Zugbolzen
Tenon
Tension bolt
No. M700G0002



Gewindestift M6 x 6
Vis pointeau M6 x 6
Set screw M6 x 6
No. D914M6X6



Lagerbolzen
Axe
Bearing pin
⊕ No. M700B0001
⊕ No. M700B0002



Gegenlaufscheibe
Rondelle
Counter direction disc
No. M700K0020



Nockenlagerbuchse
Douille avec ergot
Tappet bearing bushing
No. M700K0000



Hebespindel
Douille fileté
Lifting and lowering spindle
No. M700G0000



Abdeckkappe für
Rahmen- und Flügelbandteil
Capuchon pour bras dormant
et bras ouvrant
*Cap for frame hinge part
and door hinge blade*
No. M700K0141



Zylinderschraube M4x14
Vis à tête cylindrique M4x14
Cylinder head screw M4x14
No. M700E0011

Ancienne version ! Jusqu'à Septembre 2014
Old version until September 2014!

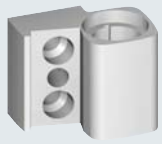

Rahmenbandteil
Bras dormant
Frame hinge part
Art.-Nr. auf Anfrage
No. d'article sur demande
Item no. on request

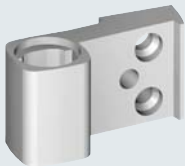

Flügelbandteil
Bras ouvrant
Door hinge blade
Art.-Nr. auf Anfrage
No. d'article sur demande
Item no. on request



**Abdeckstück
Rahmenbandteil**
Cache-vis bras dormant
Cover strip frame hinge part
Art.-Nr. auf Anfrage
No. d'article sur demande
Item no. on request



Abdeckstück Flügelbandteil
Cache-vis bras ouvrant
Cover strip door hinge part
Art.-Nr. auf Anfrage
No. d'article sur demande
Item no. on request



Befestigungsplatte
Contre-plaque de fixation
Mounting plate
Siehe Seite 2
Voir page No. 2
See page 2



Kunststoffraststift
Ergot pvc
Plastic pin
No. A700K0004



Gewindestift M6 x 6
Vis pointeau M6 x 6
Set screw M6 x 6
No. D914M6X6

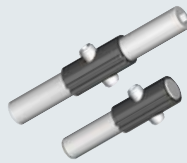

Lagerbolzen
Axe
Bearing pin
⊕ No. A700B0020
⊕ No. A700B0021



Gegenlaufscheibe
Rondelle
Counter direction disc
No. A700K0001



Lagerbuchse
Douille
Bearing bushing
No. A700K0000



Druckspindel
Douille filetée
Pressure spindle
No. A700G0000



**Abdeckkappe
Rahmenbandteil**
Capuchon bras dormant
Cap frame hinge part
No. A700K0003



Abdeckkappe Flügelbandteil
Capuchon bras ouvrant
Cap door hinge blade
No. A700K0002



Zentrierring 6 mm
Bague de centrage 6 mm
Centering ring 6 mm
No. A700E0010



Schraube M8 x 25
Vis M8 x 25
Screw M8 x 25
No. E1512801





Nouvelle version ! Depuis Juin 2020
New version June 2020!



Rahmenbandteil
Bras dormant
Frame hinge part
Art.-Nr. auf Anfrage
No. d'article sur demande
Item no. on request



Flügelbandteil
Bras ouvrant
Door hinge blade
Art.-Nr. auf Anfrage
No. d'article sur demande
Item no. on request



Abdeckstück
Rahmenbandteil
Cache-vis bras dormant
Cover strip frame hinge part
Art.-Nr. auf Anfrage
No. d'article sur demande
Item no. on request

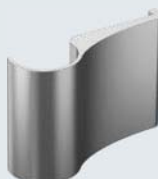

Abdeckstück Flügelbandteil
Cache-vis bras ouvrant
Cover strip door hinge blade
Art.-Nr. auf Anfrage
No. d'article sur demande
Item no. on request



Lagerbolzen
Axe
Bearing pin
No. M900E0000



Lagerbuchse
Douille
Bearing bushing
No. A900K0010
(weiß/blanc/white)
No. A900K0000
(schwarz/noir/black)



Gegenlaufscheibe
Rondelle
Counter direction disc
No. M900K0004
(weiß/blanc/white)
No. M900K0002
(schwarz/noir/black)



Druckspindel
Douille fileté
Pressure spindle
No. A900G0000



Abdeckkappe
Capuchon
Cap
No. M900K0040
(weiß/blanc/white)
No. M900K0020
(schwarz/noir/black)



Halteschraube
für Abdeckstück
Vis de fixation du cache-vis
Locking screw for cover strip
No. M900E0002



Schiebebuchse
Douille coulissante
Sliding connector
No. M900G0002



Schiebeplatte
Plaque coulissante
Sliding plate
No. M900G0001



Gewindestift mit Zapfen
Vis pointeau avec tenon
Setscrew with pin
No. M900E0003



Stellspindel
Douille fileté
Adjusting spindle
No. A900E0003



Fixierstück
Pièce de blocage
Fixture
No. A900G0006

Nouvelle version ! Depuis Juin 2020
New version June 2020!



Rahmenbandteil
Bras dormant
Frame hinge part
Art.-Nr. auf Anfrage
No. d'article sur demande
Item no. on request



Flügelbandteil
Bras ouvrant
Door hinge blade
Art.-Nr. auf Anfrage
No. d'article sur demande
Item no. on request



**Abdeckstück
Rahmenbandteil**
Cache-vis bras dormant
Cover strip frame hinge part
Art.-Nr. auf Anfrage
No. d'article sur demande
Item no. on request



Abdeckstück Flügelbandteil
Cache-vis bras ouvrant
Cover strip door hinge part
Art.-Nr. auf Anfrage
No. d'article sur demande
Item no. on request



Lagerbolzen
Axe
Bearing pin
No. M900E0001



Nockenlagerbuchse
Douille avec ergot
Tappet bearing bushing
No. M900K0003
(weiß/blanc/white)
No. M900K0001
(schwarz/noir/black)



Gegenlaufscheibe
Rondelle
Counter direction disc
No. M900K0004
(weiß/blanc/white)
No. M900K0002
(schwarz/noir/black)



Abdeckkappe
Capuchon
Cap
No. M900K0040
(weiß/blanc/white)
No. M900K0020
(schwarz/noir/black)



**Halteschraube
für Abdeckstück**
Vis de fixation du cache-vis
Locking screw for cover strip
No. M900E0002



Schiebebuchse
Douille coulissante
Sliding connector
No. M900G0002



Schiebeplatte
Plaque coulissante
Sliding plate
No. M900G0001



Gewindestift mit Zapfen
Vis pointeau avec tenon
Setscrew with pin
No. M900E0003



Stellspindel
Douille filetée
Adjusting spindle
No. A900E0003



Fixierstück
Pièce de blocage
Fixture
No. A900G0006



Hebespindel
Douille filetée
Lifting and lowering spindle
No. M900G0000





HAHN TÜRBAND 4 – ALTE AUSFÜHRUNG! BIS MAI 2020

TÜRBAND 4

Ancienne version ! Jusqu'à Mai 2020
Old version until May 2020!

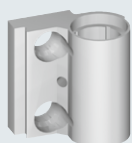

Rahmenbandteil
Bras dormant
Frame hinge part
Art.-Nr. auf Anfrage
No. d'article sur demande
Item no. on request

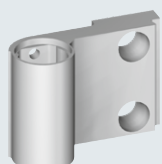

Flügelbandteil
Bras ouvrant
Door hinge blade
Art.-Nr. auf Anfrage
No. d'article sur demande
Item no. on request



Abdeckstück
Rahmenbandteil
Cache-vis bras dormant
Cover strip frame hinge part
Art.-Nr. auf Anfrage
No. d'article sur demande
Item no. on request

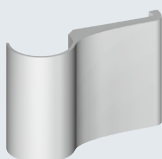

Abdeckstück Flügelbandteil
Cache-vis bras ouvrant
Cover strip door hinge blade
Art.-Nr. auf Anfrage
No. d'article sur demande
Item no. on request

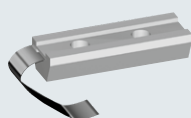

Befestigungsplatte
Contre-plaque de fixation
Mounting plate
Siehe Seite 4
Voir page No. 4
See page 4

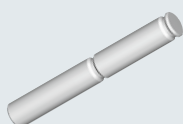

Lagerbolzen
Axe
Bearing pin
No. A900E0000



Lagerbuchse
Douille
Bearing bushing
No. A900K0010
(weiß/blanc/white)
No. A900K0000
(schwarz/noir/black)



Gegenlaufscheibe
Rondelle
Counter direction disc
No. A900K0011
(weiß/blanc/white)
No. A900K0001
(schwarz/noir/black)



Druckspindel
Douille fileté
Pressure spindle
No. A900G0000



Abdeckkappe Flügelbandteil
Capuchon bras ouvrant
Cap door hinge blade
No. A900K0012
(weiß/blanc/white)
No. A900K0002
(schwarz/noir/black)

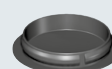

Abdeckkappe
Rahmenbandteil
Capuchon bras dormant
Cap frame hinge part
No. A900K0114
(weiß/blanc/white)
No. A900K0104
(schwarz/noir/black)



Hülse Standard
Douille standard
Sleeve standard
No. A900G0004



Halteschraube
für Abdeckstück
Vis de fixation du cache-vis
Locking screw for cover strip
No. EF15000806



Schiebebuchse
Douille coulissante
Sliding connector
No. A900G0002



Schiebeplatte
Plaque coulissante
Sliding plate
No. A900G0003



Gewindestift M6 x 10
Vis pointeau M6 x 10
Set screw M6 x 10
No. D914M6X10



Stellspindel
Douille fileté
Adjusting spindle
No. A900E0003



Fixierstück
Pièce de blocage
Fixture
No. A900G0006

Ancienne version ! Jusqu'à Mai 2020
Old version until May 2020!

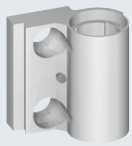

Rahmenbandteil
Bras dormant
Frame hinge part
Art.-Nr. auf Anfrage
No. d'article sur demande
Item no. on request

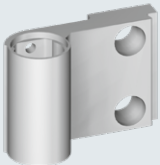

Flügelbandteil
Bras ouvrant
Door hinge blade
Art.-Nr. auf Anfrage
No. d'article sur demande
Item no. on request



Abdeckstück
Rahmenbandteil
Cache-vis bras dormant
Cover strip frame hinge part
Art.-Nr. auf Anfrage
No. d'article sur demande
Item no. on request

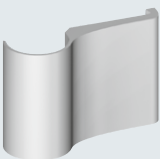

Abdeckstück Flügelbandteil
Cache-vis bras ouvrant
Cover strip door hinge blade
Art.-Nr. auf Anfrage
No. d'article sur demande
Item no. on request

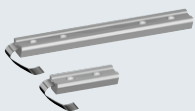

Befestigungsplatte
Contre-plaque de fixation
Mounting plate
Siehe Seite 4
Voir page No. 4
See page 4

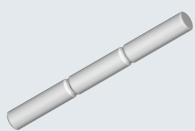

Lagerbolzen
Axe
Bearing pin
No. A900E0001



Lagerbuchse
Douille
Bearing bushing
No. A900K0013
(weiß/blanc/white)
No. A900K0003
(schwarz/noir/black)



Gegenlaufscheibe
Rondelle
Counter direction disc
No. A900K0011
(weiß/blanc/white)
No. A900K0001
(schwarz/noir/black)



Druckspindel
Douille fileté
Pressure spindle
No. A900G0000



Verstellstern
Etoile de réglage
Adjusting star
No. A900G0001

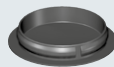

Abdeckkappe
Rahmenbandteil
Capuchon bras dormant
Cap frame hinge part
No. A900K0114
(weiß/blanc/white)
No. A900K0104
(schwarz/noir/black)



Hülse Standard
Douille standard
Sleeve standard
No. A900G0004



Halteschraube
für Abdeckstück
Vis de fixation du cache-vis
Locking screw for cover strip
No. EF15000806



Schiebebuchse
Douille coulissante
Sliding connector
No. A900G0002



Schiebeplatte
Plaque coulissante
Sliding plate
No. A900G0003



Gewindestift M6 x 10
Vis pointe M6 x 10
Set screw M6 x 10
No. D914M6X10



Stellspindel
Douille fileté
Adjusting spindle
No. A900E0003



Fixierstück
Pièce de blocage
Fixture
No. A900G0006

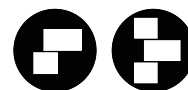

Rahmenbandteil
Bras dormant
Frame hinge part
Art.-Nr. auf Anfrage
No. d'article sur demande
Item no. on request



Flügelbandteil
Bras ouvrant
Door hinge blade
Art.-Nr. auf Anfrage
No. d'article sur demande
Item no. on request



Verstelleinheit zweiteilig
Unité de réglage deux lames
Adjustment unit two-piece
No. A105B0002



Verstelleinheit dreiteilig
Unité de réglage trois lames
Adjustment unit three-piece
No. A100B0028



Lagerbuchse
Douille
Bearing bushing
No. A100K0043
(weiß/blanc/white)
No. A100K0015
(schwarz/noir/black)



Lagerscheibe
Rondelle
Bearing disc
No. A100K0044
(weiß/blanc/white)
No. A100K0016
(schwarz/noir/black)



Gewindestift M6x8
Vis pointeau M6x8
Set screw M6x8
No. DT914M6x8/N



Gewindestift M6x5
Vis pointeau M6x5
Set screw M6x5
No. D914M6x5



Stellspindel
Douille filetée
Adjusting spindle
No. E1512210



Abdeckkappe
Capuchon
Cap
No. A100K0047
(weiß/blanc/white)
No. A100K0013
(schwarz/noir/black)



Stopfen
Bouchon
Plug
No. E3200705
(weiß/blanc/white)
No. E3200704
(schwarz/noir/black)

Alle weiteren Teile auf Anfrage · Pièces supplémentaires sur demande · *All further parts upon request*

Bei Klemmbändern handelt es sich um systemangepasste Bänder, die in enger Zusammenarbeit mit den Profilverstellern entwickelt wurden.

Verschiedene Profilkombinationen benötigen spezielle Varianten.

Zur Anfrage- und Auftragsbearbeitung ist daher die genaue Angabe der jeweils verwendeten Profilkombinationen erforderlich.

Les paumelles à clamer s'adaptent uniquement à certaines gammes de profils et ont été conçues en collaboration avec les gammistes.

Différentes combinaisons de profils exigent des versions spéciales.

C'est pourquoi nous vous prions de nous communiquer les combinaisons de profils exactes sur vos demandes d'offre de prix et vos commandes.

The Hahn clamp hinge is a system-adapted hinge which was developed in close co-operation with door manufacturers.

Different door/frame combinations require special solutions.

To help us process your enquiry and order, we require accurate information about the respective door/frame combination to be used.

Nouvelle version ! Depuis Mai 2019

New version May 2019!



Rahmenbandteil
Bras dormant
Frame hinge part
Art.-Nr. auf Anfrage
No. d'article sur demande
Item no. on request



Flügelbandteil
Bras ouvrant
Door hinge blade
Art.-Nr. auf Anfrage
No. d'article sur demande
Item no. on request



Befestigungsverstellplatte
Contreplaque de réglage
Fastening adjustment plate
Art.-Nr. auf Anfrage
No. d'article sur demande
Item no. on request



Schraube M6 x 11
Vis M6 x 11
Screw M6 x 11
No. R300E0014



Gewindestift M6x5
Vis pointeau M6x5
Set screw M6x5
No. R400E0010



Gewindestift M8 x 6
Vis pointeau M8 x 6
Set screw M8 x 6
No. A100E0040



Gewindestift M8 x 20
Vis pointeau M8 x 20
Set screw M8 x 20
No. R600E0005



Lagerbuchse Flügelbandteil
Douille bras ouvrant
Bearing bushing door hinge blade
No. R600K0001



Lagerbolzen
Axe
Bearing pin
No. R600E0007





klein
petit
small



groß
grand
large



Rahmenbandteil (klein)
Bras dormant (petit)
Frame hinge part (small)



Rahmenbandteil (groß)
Bras dormant (grand)
Frame hinge part (large)



Flügelbandteil (klein)
Bras ouvrant (petit)
Door hinge blade (small)



Flügelbandteil (groß)
Bras ouvrant (grand)
Door hinge blade (large)

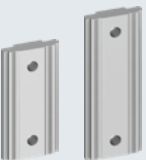

Befestigungsplatte Rahmen-
bandteil (klein/groß)
Contre-plaque de fixation
bras dormant (petit/grand)
Mounting plate frame hinge
part (small/large)



Befestigungsplatte
Flügelbandteil (klein/groß)
Contre-plaque de fixation
bras ouvrant (petit/grand)
Mounting plate door hinge
blade (small/large)



Klemmplatte Flügelbandteil
(klein/groß)
Clame lame ouvrante
(petit/grand)
Clamping plate door hinge
blade (small/large)

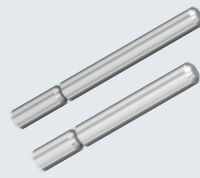

Lagerbolzen
Axe
Bearing pin
No. A100E0021
(klein/petit/small)
No. A100E0022
(groß/grand/large)

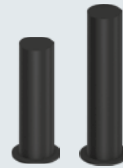

Lagerbuchse
Douille
Bearing bushing
No. A100K0056
(klein/petit/small)
No. A100K0057
(groß/grand/large)



Excenterbuchse
Flügelbandteil (groß)
Douille excentrique
lame ouvrante (grand modèle)
Excenter bushing
door hinge blade (large)
No. A100K0055



Distanzscheibe
Rondelle
Spacer
No. A100K0058



Gewindestift M6x5-TX15
Vis pointeau M6x5-TX15
Set screw M6x5-TX15
No. R400E0010



Linsen-Schaft-Schraube
Vis à tête bombée
partiellement filetée
Lens-shaft-screw
No. A100E0024



Senkschraube
Vis à tête conique
Tapping screw
No. A100E0026



Verstellschraube
Vis de réglage
Adjusting screw
No. A100E0025

Artikelnummern auf Anfrage · No. d'article sur demande · Item no. on request



Rahmenbandteil
Bras dormant
Frame hinge part



Flügelbandteil
Bras ouvrant
Door hinge blade

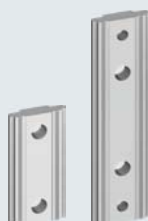

Befestigungsplatte
Flügel-/Rahmenbandteil
Contre-plaque de fixation
bras ouvrant/dormant
*Mounting plate hinge blade
for door/frame hinge part*



Lagerbolzen
Axe
Bearing pin
No. A100E0023



Lagerbuchse
Douille
Bearing bushing
No. R100K0000



Excenterbuchse
Flügelbandteil
Douille excentrique
lame ouvrante
*Excenter bushing
door hinge blade*

No. A100K0055



Gewindestift M6x5-TX15
Vis pointeau M6x5-TX15
Set screw M6x5-TX15

No. R400E0010



Linsen-Schaft-Schraube
Vis à tête bombée
partiellement filetée
Lens-shaft-screw

No. A100E0024



Senkschraube
Vis à tête conique
Tapping screw

No. A100E0026



Verstellungsschraube
Vis de réglage
Adjusting screw

No. A100E0025



Artikelnummern auf Anfrage · No. d'article sur demande · *Item no. on request*

Bei Klemmbändern handelt es sich um systemangepasste Bänder, die in enger Zusammenarbeit mit den Profilverstellern entwickelt wurden.

Verschiedene Profilkombinationen benötigen spezielle Varianten.

Zur Anfrage- und Auftragsbearbeitung ist daher die genaue Angabe der jeweils verwendeten Profilkombinationen erforderlich.

Les paumelles à clamer s'adaptent uniquement à certaines gammes de profils et ont été conçues en collaboration avec les gammistes.

Différentes combinaisons de profils exigent des versions spéciales.

C'est pourquoi nous vous prions de nous communiquer les combinaisons de profils exactes sur vos demandes d'offre de prix et vos commandes.

The Hahn clamp hinge is a system-adapted hinge which was developed in close co-operation with door manufacturers.

Different door/frame combinations require special solutions.

To help us process your enquiry and order, we require accurate information about the respective door/frame combination to be used.

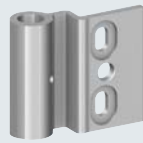

Rahmenbandteil
Bras dormant
Frame hinge part



Flügelbandteil
Bras ouvrant
Door hinge blade



Lagerbuchsen
Douilles
Bearing bushings
No. R100K0005
(weiß/blanc/white)
No. R100K0004
(schwarz/noir/black)



Lagerbolzen
Axe
Bearing pin
No. R100E0000



**Adapterplatten
je nach Ausführung**
Platines d'adaptation selon
modèle en fonction du modèle
*Adaptor plates depending
on version*

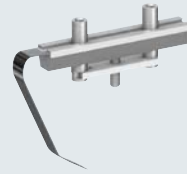

Verstelleinheit
Flügelbandteil
Unité de réglage bras ouvrant
*Adjustment unit door hinge
blade*



Futterplatte
Cale
Lining plate



Befestigungsplatte
Rahmenbandteil
Contre-plaque de fixation
bras dormant
*Mounting plate frame hinge
part*



FBT Schrauben-Set
Kit de vis pour bras ouvrant
*Set of screws for hinge part
of door*



RBT Schrauben-Set
Kit de vis pour bras dormant
*Set of screws for hinge part
of frame*

Artikelnummern auf Anfrage · No. d'article sur demande · *Item no. on request*

Bei Rollenbändern NG handelt es sich um systemangepasste Bänder, die in enger Zusammenarbeit mit den Profilverstellern entwickelt wurden.

Verschiedene Profilkombinationen benötigen spezielle Varianten.

Zur Anfrage- und Auftragsbearbeitung ist daher die genaue Angabe der jeweils verwendeten Profilkombinationen erforderlich.

Les paumelles à rouleaux NG s'adaptent uniquement à certaines gammes de profils et ont été conçues en collaboration avec les gammistes.

Différentes combinaisons de profils exigent des versions spéciales.

C'est pourquoi nous vous prions de nous communiquer les combinaisons de profils exactes sur vos demandes d'offre de prix et vos commandes.

The Hahn Rollenband NG is a system-adapted hinge which was developed in close co-operation with door manufacturers.

Different door/frame combinations require special solutions.

To help us process your enquiry and order, we require accurate information about the respective door/frame combination to be used.



Rahmenbandteil
Partie dormante
Frame hinge part
Art.-Nr. auf Anfrage
No. d'article sur demande
Item no. on request



Flügelbandteil
Partie ouvrante
Door hinge blade
Art.-Nr. auf Anfrage
No. d'article sur demande
Item no. on request



Lagerbolzen
Axe
Bearing pin
No. A100E0048



Lagerbuchse
Douille
Bearing bushing
No. A100K0057



Befestigungssegment rahmenseitig
Clames coté dormant
Fastening segment frame-side
No. A100G0007



Befestigungsplatte
Contre-plaque de fixation
Mounting plate
No. A100F0478

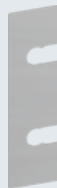

Distanzplatte VE = 50 Stück
cale UE = 50 pièces
Spacer plate PU = 50 pieces
No. A150A0021



Distanzscheibe
Rondelle
Spacer
No. A100K0058



Gewindestift M6x5
Vis pointeau M6x5
Set screw M6x5
No. DIN914M6x5



Gewindestift M6x8
Vis pointeau M6x8
Set screw M6x8
No. DIN914M6x8



Senkschraube
DIN 7991; M6x12
Vis à tête conique
DIN 7991; M6x12
Tapping screw
DIN 7991; M6x12
No. DIN7991M6x12



Linsen-Flansch-Schraube
M6x12
Vis à tête bombée M6x12
Lens-head flange screw M6x12
No. ISO7380-2_M6x12



Bohrschraube 5 x 20
Vis auto-perforante 5 x 20
Self-drilling screw 5 x 20
No. K400E0006



**Rahmenbandteil**
RAL-Farbe oder Nasslackton
angeben

Partie dormante
Spécifiez la teinte RAL ou
le laquage liquide souhaité
Frame hinge part
Indicate RAL or liquid coating
colour

No. A500B0000**Flügelbandteil**
RAL-Farbe oder Nasslackton
angeben

Partie ouvrante
Spécifiez la teinte RAL ou
le laquage liquide souhaité
Door hinge blade
Indicate RAL or liquid coating
colour

No. A500F0001**Abdeckstück**
RAL-Farbe oder Nasslackton
angeben

Cache-vis
Spécifiez la teinte RAL ou
le laquage liquide souhaité
Cover strip
Indicate RAL or liquid coating
colour

No. K200G0005**Lagerbolzen**

Axe
Bearing pin

No. K700G0002**Lagerbuchse**

Douille
Bearing bushing

No. K200B0001
(schwarz/noir/black)**No. K200B0006**
(weiß/blanc/white)**Befestigungsteil**

Pièce de fixation
Mounting piece

No. K300B0006**Halteschraube**
für Abdeckstück (klein)

Vis de fixation du cache-vis
(petite)

Locking screw for cover strip
(small)

No. E3300802**Bohrschraube 5 x 25**

Vis auto-perforante 5 x 25
Self-drilling screw 5 x 25

No. E3300803**Schraube**

Vis
Screw

K200E0002**Gewindestift M6x5 DIN 914**

Vis pointeau M6x5 DIN 914
Set screw M6x5 DIN 914

No. DIN914M6x5**Verstellterappe für Aufdeck-**
situationen 7–11 mm

(VE = 50 Stück, roh)

Cale escalier pour recouvre-
ment de 7 à 11 mm
(UE = 50 pièces, brut)

Adjustable step for upstand
situations 7–11 mm
(PU = 50 pieces, mill finish)

No. A500A0000

PRÄZISE EINGESTELLT

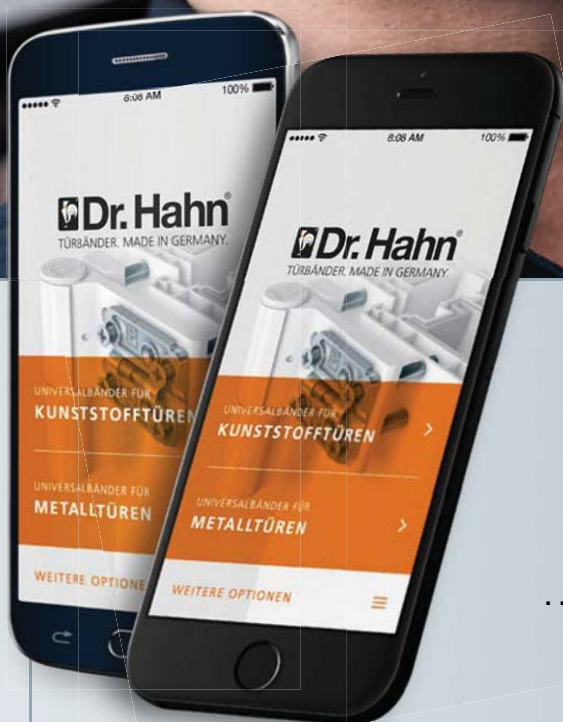

Jetzt immer dabei:
Die Einstellanleitungen
der Hahn Bänder ...

... mit Bild und Video, jetzt kostenlos
erhältlich für Android und iOS im
AppStore und bei **Google Play**.

*Für jede Situation
die passende Lösung*

www.dr-hahn.eu/anleitungen





UNIVERSALBÄNDER FÜR METALLTÜREN

Paumelles universelles pour portes métalliques

Universal hinges for metal doors

SERIE 60 AT



Universalband für vielfältigen Einsatz
Paumelle universelle pour une multitude d'application
Universal hinge for various applications

SERIE 60 AT



Universalband für vielfältigen Einsatz
Paumelle universelle pour une multitude d'application
Universal hinge for various applications

TÜRBAND 4



Universalband in Rollenoptik
Paumelle universelle en optique cylindrique
Universal hinge with butt hinge appearance

TÜRBAND 4



Universalband in Rollenoptik
Paumelle universelle en optique cylindrique
Universal hinge with butt hinge appearance

KLEMMband

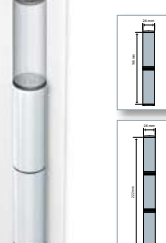

Klemmband für Haustüren
Paumelle à clamer pour habitations individuelles
Clamp hinge for residential doors

KLEMMband NG

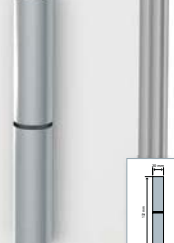

Klemmband für repräsentative Eingänge
Paumelle à clamer pour entrées prestigieuses
Clamp hinge for representative entrances

KLEMMband NG

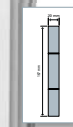

Klemmband für repräsentative Eingänge
Paumelle à clamer pour entrées prestigieuses
Clamp hinge for representative entrances

ROLLENband NG

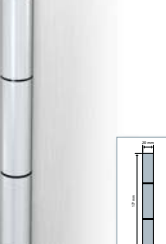

Rollenband für repräsentative Eingänge
Paumelle cylindrique pour porte haut de gamme
Butt hinge for representative entrances

Rollenband G

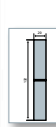
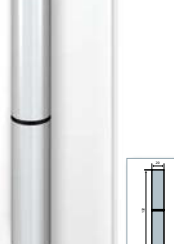

Rollenband für leichte Aluminiumtüren
Paumelle cylindrique pour portes légères en aluminium
Butt hinge for lightweight aluminium doors

VL-Band AL



Verdeckt liegendes Band für Aluminiumtüren
Paumelle invisible pour portes en aluminium
Concealed hinge for aluminium doors

VL-Band ST



Verdeckt liegendes Band für Stahltüren
Paumelle invisible pour portes en acier
Concealed hinge for steel doors

AT-G



Universalband für leichte Aluminiumtüren
Paumelle universelle pour portes légères en aluminium
Universal hinge for lightweight aluminium doors

UNIVERSALBÄNDER FÜR KUNSTSTOFFTÜREN

Paumelles universelles pour portes PVC

Universal hinges for PVC doors

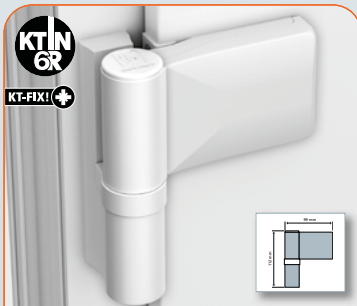

Für repräsentative Eingangstüren
Pour portes d'entrée haut de gamme
For representative door entrances

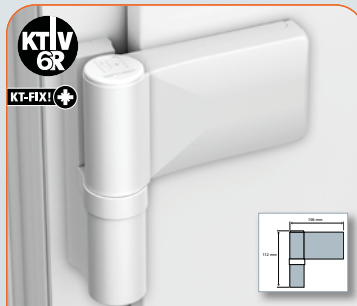

Für repräsentative Eingangstüren
Pour portes d'entrée haut de gamme
For representative door entrances

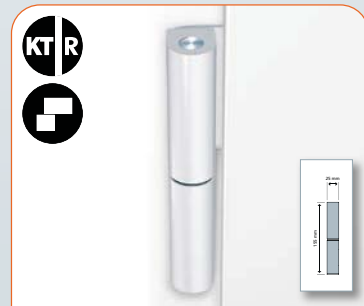

Rollenband für Eingangstüren
Paumelle cylindrique pour portes d'entrée principale
Butt hinge for entrance doors

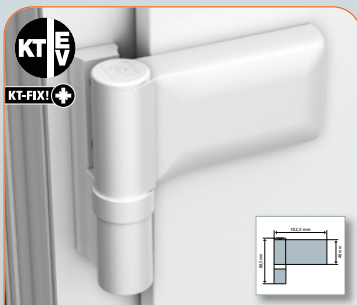

Für Haus- und Nebeneingangstüren
Pour portes d'entrée principales et secondaires
For residential and side entrance doors

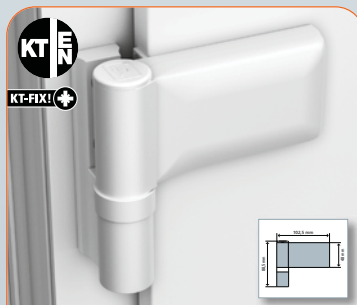

Für Haus- und Nebeneingangstüren
Pour portes d'entrée principales et secondaires
For residential and side entrance doors

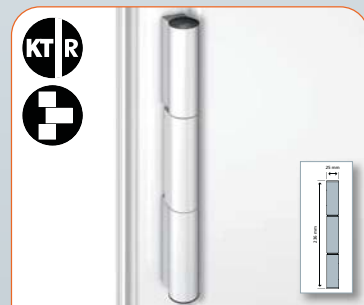

Rollenband für Eingangstüren
Paumelle cylindrique pour portes d'entrée principale
Butt hinge for entrance doors

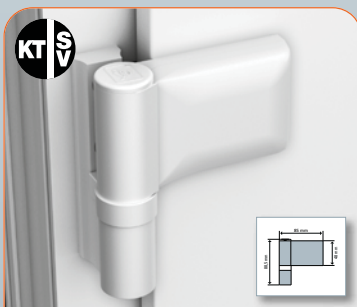

Für Nebeneingangstüren
Pour portes d'entrée secondaires
For side entrance doors

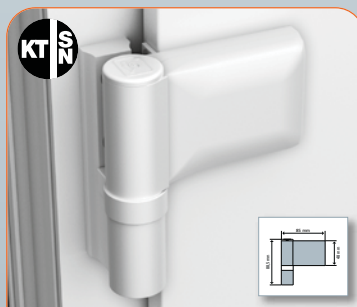

Für Nebeneingangstüren
Pour portes d'entrée secondaires
For side entrance doors

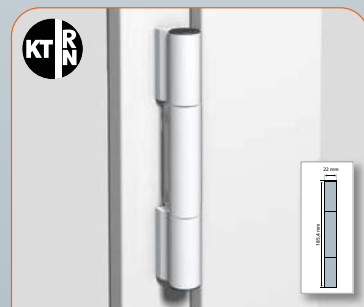

Rollenband für Kunststofftüren
Paumelle cylindrique pour portes PVC
Butt hinge for PVC doors



Das einfache Band für leichte Türen
La paumelle simple pour portes légères
The simple hinge for light doors

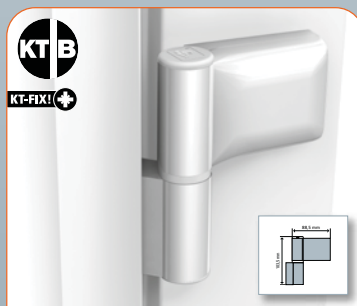

Aufschraubband für Türen aus Blockprofilen
Paumelle de porte pour dormant monobloc
Screw-on hinge for block profile doors



Verdeckt liegendes Band für Kunststofftüren
Paumelle invisible pour portes PVC
Concealed hinge for PVC doors



HAHN KT-N 6R/KT-V 6R – NEUE AUSFÜHRUNG! AB 2017

Nouvelle version ! Depuis 2017
New version 2017!



Rahmenbandteil
RAL-Farbe angeben
Partie dormante
Mentionner teinte RAL
Frame hinge part
Indicate RAL colour
Art.-Nr. auf Anfrage
No. d'article sur demande
Item no. on request

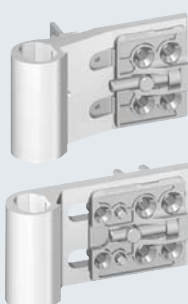

**Flügelbandteil
mit Verstelleinheit**
RAL-Farbe angeben
Partie ouvrante
avec unité d'ajustage
Mentionner teinte RAL
Door hinge blade
with adjustment unit
Indicate RAL colour
No. K400B0044 (KT-N 6R)
No. K500B0002 (KT-V 6R)



Abdeckstück
RAL-Farbe angeben
Cache-vis
Mentionner teinte RAL
Cover strip
Indicate RAL colour
No. K400G0008 (KT-N 6R)
No. K500G0004 (KT-V 6R)



Lagerbolzen komplett
Axe complet
Bearing pin, complete
No. K400B0047



Abdeckkappe
Capuchon
Cap
No. K400K0123
(weiß/blanc/white)
No. K400K0124
(schwarz/noir/black)



Halteschraube
für Abdeckstück (klein)
Vis de fixation du cache-vis
(petite)
Locking screw for cover strip
(small)
No. E3300802



Bohrschraube 6,3 x 49
Vis auto-perforante 6,3 x 49
Self-drilling screw 6.3 x 49
No. K400E0041



Senkblechschraube 6 x 40
Vis à tête 6 x 40
Countersunk head tapping
screw 6 x 40
No. EF9000521



**Bohrschraube für Aufdeck-
verschraubung KT-N 6R**
Vis auto-perforante pour
fixation sur le chant
de l'ouvrant KT-N 6R
Self-drilling screw for screw
pilot holes KT-N 6R
No. E3300803



Lagerbuchse mit Hebespindel
Douille PVC avec douille filetée
Bearing bushing with lowering
and lifting spindle
No. K400B0151
(weiß/blanc/white)
No. K400B0150
(schwarz/noir/black)

Ancienne version ! Jusqu'à 2016

Old version until 2016!



Rahmenbandteil
RAL-Farbe angeben
Partie dormant
Mentionner teinte RAL
Frame hinge part
Indicate RAL colour
Art.-Nr. auf Anfrage
No. d'article sur demande
Item no. on request



Flügelbandteil mit Verstelleinheit
RAL-Farbe angeben
Partie ouvrante avec unité d'ajustage
Mentionner teinte RAL
Door hinge blade with adjustment unit
Indicate RAL colour
No. K400B0044 (KT-N 6R)
No. K500B0002 (KT-V 6R)

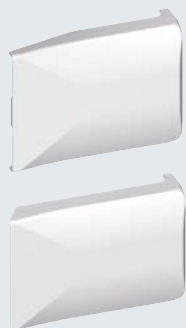

Abdeckstück
RAL-Farbe angeben
Cache-vis
Mentionner teinte RAL
Cover strip
Indicate RAL colour
No. K400G0008 (KT-N 6R)
No. K500G0004 (KT-V 6R)



Lagerbolzen komplett
Axe complet
Bearing pin, complete
No. K400B0047



Lagerbuchse
Douille
Bearing bushing
No. K400K0021
(weiß/blanc/white)
No. K400K0022
(schwarz/noir/black)



Abdeckkappe
Capuchon
Cap
No. K400K0123
(weiß/blanc/white)
No. K400K0124
(schwarz/noir/black)



Halteschraube für Abdeckstück (klein)
Vis de fixation du cache-vis (petite)
Locking screw for cover strip (small)
No. E3300802



Schraube für Rahmenbandteil
Vis pour bras dormant
Screw for frame hinge part
No. E3400801
Aufdeckbereiche I + II
Cote de recouvrement I + II
Upstand range I + II
6,3 x 45

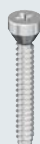

No. K400E0014
Aufdeckbereiche III + IV
Cote de recouvrement III + IV
Upstand range III + IV
6,3 x 53



Senkblechschraube 6 x 40
Vis à tôle 6 x 40
Countersunk head tapping screw 6 x 40
No. EF9000521



Bohrschraube für Aufdeckverschraubung KT-N 6R
Vis auto-perforante pour fixation sur le chant de l'ouvrant KT-N 6R
Self-drilling screw for screw pilot holes KT-N 6R
No. E3300803



Hebespindel
Douille filetée
Lifting and lowering spindle
No. K400K0037
(weiß/blanc/white)
No. K400K0036
(schwarz/noir/black)





HAHN KT-N 6R/KT-V 6R MIT KT-FIX – NEUE AUSFÜHRUNG! AB 2017

avec KT-FIX – Nouvelle version ! Depuis 2017
with KT-FIX – New version 2017!



Rahmenbandteil
RAL-Farbe angeben
Partie dormante
Mentionner teinte RAL
Frame hinge part
Indicate RAL colour
Art.-Nr. auf Anfrage
No. d'article sur demande
Item no. on request



Flügelbandteil KT-N mit Befestigungsteil
RAL-Farbe angeben
Partie ouvrante KT-N
avec pièce de fixation
Mentionner teinte RAL
*Door hinge blade KT-N
with mounting part*
Indicate RAL colour
No. K400B0093



Flügelbandteil KT-V
RAL-Farbe angeben
Partie ouvrante KT-V
Mentionner teinte RAL
Door hinge blade KT-V
Indicate RAL colour
No. K500B0010



Befestigungsteil KT-V
Pièce de fixation KT-V
Mounting piece KT-V
No. K500B0011

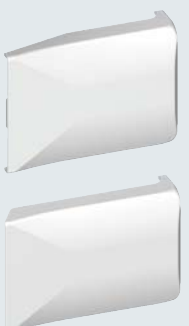

Abdeckstück
RAL-Farbe angeben
Cache-vis
Mentionner teinte RAL
Cover strip
Indicate RAL colour
No. K400G0008 (KT-N 6R)
No. K500G0004 (KT-V 6R)



Lagerbolzen komplett
Axe complet
Bearing pin, complete
No. K400B0047



Abdeckkappe
Capuchon
Cap
No. K400K0023
(weiß/blanc/white)
No. K400K0024
(schwarz/noir/black)



Lagerbuchse mit Hebespindel
Douille PVC avec douille fileté
*Bearing bushing with lowering
and lifting spindle*
No. K400B0151
(weiß/blanc/white)
No. K400B0150
(schwarz/noir/black)



**Halteschraube
für Abdeckstück (klein)**
Vis de fixation du cache-vis (petite)
*Locking screw for cover strip
(small)*
No. E3300802



Bohrschraube
Vis auto-perforante pour
bras dormant
Self-drilling screw
No. K400E0041
Aufdeckbereiche II, III + IV
Cote de recouvrement II, III + IV
Upstand range II, III + IV
6,3 x 49



**Bohrschraube für Aufdeck-
verschraubung KT-N 6R**
Vis auto-perforante pour
fixation sur le chant
de l'ouvrant KT-N 6R
*Self-drilling screw for screw
pilot holes KT-N 6R*
No. E3300803



Senkschraube M5x50
Vis à tête conique M5x50
Flat-headed screw M5x50
No. K400E0034

HAHN KT-N 6R/KT-V 6R MIT KT-FIX – ALTE AUSFÜHRUNG! BIS 2016

avec KT-FIX – Ancienne version ! Jusqu'à 2016
with KT-FIX – Old version until 2016!



Rahmenbandteil
RAL-Farbe angeben
Partie dormante
Mentionner teinte RAL
Frame hinge part
Indicate RAL colour
Art.-Nr. auf Anfrage
No. d'article sur demande
Item no. on request

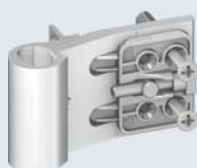

Flügelbandteil KT-N mit Befestigungsteil
RAL-Farbe angeben
Partie ouvrante KT-N
avec pièce de fixation
Mentionner teinte RAL
Door hinge blade KT-N with mounting part
Indicate RAL colour
No. K400B0093



Flügelbandteil KT-V
RAL-Farbe angeben
Partie ouvrante KT-V
Mentionner teinte RAL
Door hinge blade KT-V
Indicate RAL colour
No. K500B0004



Befestigungsteil KT-V
Pièce de fixation KT-V
Mounting piece KT-V
No. K500B0005



Abdeckstück
RAL-Farbe angeben
Cache-vis
Mentionner teinte RAL
Cover strip
Indicate RAL colour



No. K400G0008 (KT-N 6R)
No. K500G0004 (KT-V 6R)



Lagerbolzen komplett
Axe complet
Bearing pin, complete
No. K400B0047



Abdeckkappe
Capuchon
Cap
No. K400K0023
(weiß/blanc/white)
No. K400K0024
(schwarz/noir/black)



Lagerbuchse
Douille
Bearing bushing
No. K400K0021
(weiß/blanc/white)
No. K400K0022
(schwarz/noir/black)



Halteschraube für Abdeckstück (klein)
Vis de fixation du cache-vis (petite)
Locking screw for cover strip (small)

No. E3300802



Bohrschraube
Vis auto-perforante pour bras dormant
Self-drilling screw
No. K400E0026
Aufdeckbereiche II, III + IV
Cote de recouvrement II, III + IV
Upstand range II, III + IV
6,3 x 51



Bohrschraube für Aufdeckverschraubung KT-N 6R
Vis auto-perforante pour fixation sur le chant de l'ouvrant KT-N 6R
Self-drilling screw for screw pilot holes KT-N 6R
No. E3300803

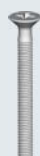

Senkschraube M5x50
Vis à tête conique M5x50
Flat-headed screw M5x50
No. K400E0034



Hebespindel
Douille filetée
Lifting and lowering spindle
No. K400K0037
(weiß/blanc/white)
No. K400K0036
(schwarz/noir/black)





HAHN KT-EN/KT-EV – NEUE AUSFÜHRUNG! AB 2017

Nouvelle version ! Depuis 2017
New version 2017!



Rahmenbandteil
RAL-Farbe angeben
Bras dormant
Mentionner teinte RAL
Frame hinge part
Indicate RAL colour

Art.-Nr. auf Anfrage
No. d'article sur demande
Item no. on request



**Lagerbuchse
mit Hebespindel**
Douille PVC avec douille filetée
*Bearing bushing with lowering
and lifting spindle*

Art.-Nr. auf Anfrage
No. d'article sur demande
Item no. on request



**Flügelbandteil KT-EV,
Verstelleinheit vormontiert**
RAL-Farbe angeben
Bras ouvrant KT-EV,
unité d'ajustage prémontée
Mentionner teinte RAL
*Door hinge blade KT-EV,
adjustment unit pre-assembled*
Indicate RAL colour

No. K200B0159



Flügelbandteil KT-EV FIX
RAL-Farbe angeben
Bras ouvrant KT-EV FIX
Mentionner teinte RAL
Door hinge blade KT-EV FIX
Indicate RAL colour

No. K200BF159



Lagerbolzen für KT-EV/KT-EN
Axe pour KT-EV/KT-EN
Bearing pin for KT-EV/KT-EN

No. K200E0009



Abdeckkappe für KT-EV/KT-EN
Capuchon pour KT-EV/KT-EN
Cap for KT-EV/KT-EN

No. K200K0011
(weiß/blanc/white)

No. K200K0010
(schwarz/noir/black)



**Flügelbandteil KT-EN,
Verstelleinheit mit
Anschlagwinkel vormontiert**
RAL-Farbe angeben

Bras ouvrante KT-EN,
unité d'ajustage avec équerre
prémontée
Mentionner teinte RAL
*Door hinge blade KT-EN,
adjustment unit with angle
steel pre-assembled*
Indicate RAL colour

No. K200B0158



Abdeckstück
RAL-Farbe angeben

Cache-vis
Mentionner teinte RAL
Hinge cover
Indicate RAL colour

No. K200G0006



**Befestigungsteil
für KT-EV FIX**
Pièce de fixation
pour KT-EV FIX
Mounting piece
For KT-EV FIX

No. K200B0157



Senkblechschraube 6 x 40
Vis à tête conique 6 x 40
*Countersunk head tapping
screw 6 x 40*

No. EF9000521



**Halteschraube für
Abdeckstück (klein)**
Vis de fixation du cache-vis
(petite)
*Locking screw for cover strip
(small)*

No. E3300802



Bohrschraube 5,5 x 48 mm
Vis auto-perforante
Self-drilling screw

No. K700E0004



**Zylinderschraube
für KT-EV/KT-EN**
Vis à tête cylindrique
pour KT-EV/KT-EN
*Cylinder head screw
for KT-EV/KT-EN*

No. K200E0011



Rahmenbandteil
RAL-Farbe angeben
Bras dormant
Mentionner teinte RAL
Frame hinge part
Indicate RAL colour

Art.-Nr. auf Anfrage
No. d'article sur demande
Item no. on request

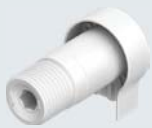

Lagerbuchse mit Hebespindel
Douille PVC avec douille fileté
Bearing bushing with lowering
and lifting spindle

Standardrahmen/dormant
standard/standart frames

No. K200B0047
(weiß/blanc/white)
No. K200B0046
(schwarz/noir/black)

Schmale Rahmen/dormant
étroit/narrow frames

No. K200B0049
(weiß/blanc/white)
No. K200B0048
(schwarz/noir/black)

Sehr schmale Rahmen/dormant
très étroit/very narrow frames

No. K200B0051
(weiß/blanc/white)
No. K200B0050
(schwarz/noir/black)



Flügelbandteil
RAL-Farbe angeben
Bras ouvrant
Mentionner teinte RAL
Door hinge blade
Indicate RAL colour

No. K200F0001 (KT-E)
No. K200F0022 (KT-EV)



Lagerbolzen für KT-EV/KT-EN
Axe pour KT-EV/KT-EN
Bearing pin for KT-EV/KT-EN

No. K200E0009



Abdeckkappe für KT-EV/KT-EN
Capuchon pour KT-EV/KT-EN
Cap for KT-EV/KT-EN

No. K200K0011
(weiß/blanc/white)
No. K200K0010
(schwarz/noir/black)

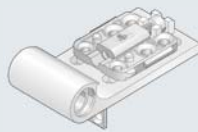

Flügelbandteil KT-EN,
Verstelleinheit mit
Anschlagwinkel vormontiert
RAL-Farbe angeben
Bras ouvrante KT-EN,
unité d'ajustage avec équerre
prémontée
Mentionner teinte RAL
Door hinge blade KT-EN,
adjustment unit with angle
steel pre-assembled
Indicate RAL colour

No. K200B0040



Verstelleinheit KT-E/KT-EV
Unité d'ajustage KT-E/KT-EV
Adjustment unit KT-E/KT-EV

No. K200B0037



Befestigungsteil
für KT-EV FIX

Pièce de fixation
pour KT-EV FIX
Mounting piece
For KT-EV FIX

No. K200B0060



Abdeckstück
RAL-Farbe angeben
Cache-vis
Mentionner teinte RAL
Hinge cover
Indicate RAL colour

No. K200G0006



Senkblechschraube 6 x 40
Vis à tôle à tête conique 6 x 40
Countersunk head tapping
screw 6 x 40

No. EF9000521



Halteschraube für
Abdeckstück (klein)
Vis de fixation du cache-vis
(petite)
Locking screw for cover strip
(small)

No. E3300802



Zylinderschraube
für KT-EV/KT-EN
Vis à tête cylindrique
pour KT-EV/KT-EN
Cylinder head screw
for KT-EV/KT-EN

No. K200E0011

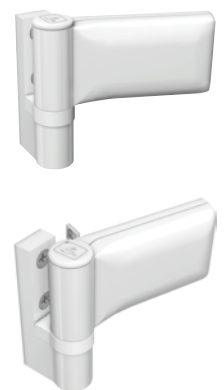



HAHN KT-SN/KT-SV – NEUE AUSFÜHRUNG! AB 2017

Nouvelle version ! Depuis 2017
New version 2017!



Rahmenbandteil
RAL-Farbe angeben
Bras dormant
Mentionner teinte RAL
*Frame hinge part
Indicate RAL colour*

Art.-Nr. auf Anfrage
No. d'article sur demande
Item no. on request



Lagerbuchse mit Hebespindel
Douille PVC avec douille filetée
*Bearing bushing with lowering
and lifting spindle*

No. K200B0151
(weiß/blanc/white)
No. K200B0150
(schwarz/noir/black)



Lagerbolzen für KT-SV/KT-SN
Axe pour KT-SV/KT-SN
Bearing pin for KT-SV/KT-SN

No. K200E0009



Abdeckkappe für KT-SV/KT-SN
Capuchon pour KT-SV/KT-SN
Cap for KT-SV/KT-SN

No. K200K0011
(weiß/blanc/white)
No. K200K0010
(schwarz/noir/black)



Flügelbandteil KT-SN,
Verstelleinheit mit
Anschlagwinkel vormontiert
RAL-Farbe angeben
Bras ouvrante KT-SN,
unité d'ajustage avec équerre
prémontée
Mentionner teinte RAL
*Door hinge blade KT-SN,
adjustment unit with angle steel
pre-assembled
Indicate RAL colour*

No. K300B0010

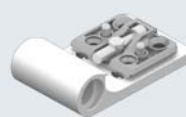

Flügelbandteil KT-SV,
Verstelleinheit vormontiert
RAL-Farbe angeben
Bras ouvrant KT-SV,
unité d'ajustage prémontée
Mentionner teinte RAL
*Door hinge blade KT-SV,
adjustment unit pre-assembled
Indicate RAL colour*

No. K300B0011



Abdeckstück
RAL-Farbe angeben
Cache-vis
Mentionner teinte RAL
*Hinge cover
Indicate RAL colour*

No. K200G0005



Senkblechschraube 6 x 40
Vis à tôle à tête conique 6 x 40
*Countersunk head tapping
screw 6 x 40*

No. EF9000521

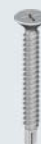

Bohrschraube 5,5 x 48 mm
Vis auto-perforante
Self-drilling screw

No. K700E0004



Halteschraube für
Abdeckstück (klein)
Vis de fixation du cache-vis
(petite)
*Locking screw for cover strip
(small)*

No. E3300802



Zylinderschraube
für KT-SV/KT-SN
Vis à tête cylindrique
pour KT-SV/KT-SN
*Cylinder head screw
for KT-SV/KT-SN*

No. K200E0011

Ancienne version ! Jusqu'à 2016
Old version until 2016!



Rahmenbandteil
RAL-Farbe angeben
Bras dormant
Mentionner teinte RAL
Frame hinge part
Indicate RAL colour

Art.-Nr. auf Anfrage
No. d'article sur demande
Item no. on request



Lagerbuchse mit Hebespindel
Douille PVC avec douille fileté
Bearing bushing with lowering
and lifting spindle

No. K200B0047
(weiß/blanc/white)
No. K200B0046
(schwarz/noir/black)

schmale/sehr schmale Rahmen
dormant étroit / dormant très
étroit
narrow/very for narrow frames

Art.-Nr. auf Anfrage
No. d'article sur demande
Item no. on request



Flügelbandteil
RAL-Farbe angeben
Bras ouvrant
Mentionner teinte RAL
Door hinge blade
Indicate RAL colour

No. K300F0006 (KT-S)
No. K300F0007 (KT-SV)



Lagerbolzen für KT-SV/KT-SN
Axe pour KT-SV/KT-SN
Bearing pin for KT-SV/KT-SN

No. K200E0009



Abdeckkappe für KT-SV/KT-SN
Capuchon pour KT-SV/KT-SN
Cap for KT-SV/KT-SN

No. K200K0011
(weiß/blanc/white)
No. K200K0010
(schwarz/noir/black)

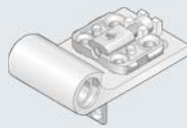

Flügelbandteil KT-SN,
Verstelleinheit mit
Anschlagwinkel vormontiert
RAL-Farbe angeben
Bras ouvrante KT-SN,
unité d'ajustage avec équerre
prémontée
Mentionner teinte RAL
Door hinge blade KT-SN,
adjustment unit with angle
steel pre-assembled
Indicate RAL colour

No. K300B0004



Verstelleinheit KT-S/KT-SV
Unité d'ajustage KT-S/KT-SV
Adjustment unit KT-S/KT-SV

No. K300B0006 (KT-SV)



Abdeckstück
RAL-Farbe angeben
Cache-vis
Mentionner teinte RAL
Hinge cover
Indicate RAL colour

No. K200G0005



Senkblechschraube 6 x 40
Vis à tête conique 6 x 40
Countersunk head tapping
screw 6 x 40

No. EF9000521



Halteschraube für
Abdeckstück (klein)
Vis de fixation du cache-vis
(petite)
Locking screw for cover strip
(small)

No. E3300802



Zylinderschraube
für KT-SV/KT-SN
Vis à tête cylindrique
pour KT-SV/KT-SN
Cylinder head screw
for KT-SV/KT-SN

No. K200E0011

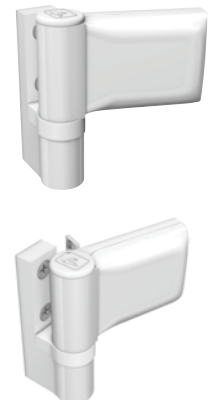

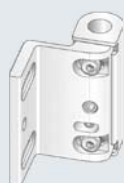

Flügelbandteil komplett
RAL-Farbe angeben
Bras ouvrant complet
Mentionner teinte RAL
Door hinge blade complete
Indicate RAL colour

No. K700B0001
(Standard/standard/standard)

No. K700B0008
(VEKA)

No. K700B0007
(gekürzt/raccourcie/shortened)



Befestigungsplatte
16/3,0 mm Beschlagnut
Contre-plaque de fixation
16/3,0 mm de rainure
Mounting plate
16/3.0 mm hinge groove

No. K700B0002



Befestigungsplatte
20/3,5 mm Beschlagnut
Contre-plaque de fixation
20/3,5 mm de rainure
Mounting plate
20/3.5 mm hinge groove

No. K700B0003



Befestigungsplatte
16/3,5 mm Beschlagnut
Contre-plaque de fixation
16/3,5 mm de rainure
Mounting plate
16/3.5 mm hinge groove

No. K700B0010

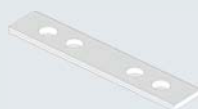

VEKA-Befestigungsplatte
24/4,0 mm Beschlagnut
VEKA-Contre-plaque de
fixation 24/4,0 mm de rainure
VEKA-Mounting plate
20/4.0 mm hinge groove

No. K700F0007



Abdeckkappe
Capuchon
Cap

No. K700K0003
(weiß/blanc/white)

No. K700K0002
(schwarz/noir/black)

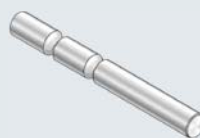

Lagerbolzen
Axe
Bearing pin

No. K700E0001



Lagerbuchse
Douille PVC
Bearing bushing

No. K700K0001
(weiß/blanc/white)
No. K700K0000
(schwarz/noir/black)



Rahmenbandteil mit
Höhenverstellspindel
RAL-Farbe angeben

Bras dormant avec douille
filetée

Mentionner teinte RAL

*Frame hinge part with vertical
adjustment spindle*
Indicate RAL colour

No. K700B0000



Blende
RAL-Farbe angeben

Fourreau cache-vis
Mentionner teinte RAL

Front cover

Indicate RAL colour

No. K700F0004



Schraube
für Rahmenbandteil

Vis pour bras dormant

Screw for frame hinge part

No. K400E0041



Schraube für
Befestigungsplatte 6 x 40

Vis pour contre-plaque

de fixation 6x40

Screw for mounting plate 6 x 40

No. EF9000521



Zylinderschraube für
Flügelbandteilbefestigung

Vis cylindrique pour ouvrant

*Pan head screw for mounting
door hinge blade*

No. D7984M6x12



Rahmenbandteil
RAL-Farbe angeben
Bras dormant
Mentionner teinte RAL
Frame hinge part
Indicate RAL colour

Art.-Nr. auf Anfrage
No. d'article sur demande
Item no. on request



Flügelbandteil
RAL-Farbe angeben
Bras ouvrant
Mentionner teinte RAL
Door hinge blade
Indicate RAL colour

Art.-Nr. auf Anfrage
No. d'article sur demande
Item no. on request



FBT Zwischenstück
Pièce intermédiaire
bras ouvrant
Wing hinge part interface

No. K700B0002



Lagerbuchse
Douille PVC
Bearing bushing

No. K700K0000
(schwarz/noir/black)
No. K700K0001
(weiß/blanc/white)



Lagerbuchse kurz
Petite douille PVC
Bearing bushing short

No. K700E0006
(schwarz/noir/black)
No. K700E0009
(weiß/blanc/white)



Exzenterbolzen
Came
Eccentric pin

No. K700E0000



Hebespindel
Douille filetée
Lifting and lowering spindle

No. A100G0003



Blende
RAL-Farbe angeben
Fourreau cache-vis
Mentionner teinte RAL
Front cover
Indicate RAL colour

No. K700F0004



Abdeckkappe
Capuchon
Cap hinge blade

No. K700K0002
(schwarz/noir/black)
No. K700K0003
(weiß/blanc/white)



Lagerbolzen
Axe
Bearing pin

No. K700E0007



Schraube
für Rahmenbandteil
Vis pour bras dormant
Screw for frame hinge part

No. K400E0041



Zylinderschraube M6x12
Vis à tête cylindrique M6x12
Pan head screw M6x12

No. D7984M6X12



Zylinderschraube M6x10
Vis à tête cylindrique M6x10
Pan head screw M6x10

No. D7984M6X10



Senkblechschaube
Vis à tôle
Countersunk head tapping screw

No. 9000521



Gewindestift M6x10
Vis pointeau M6x10
Set screw M6x10

No. DIN916-M6x10





Rahmenbandteil
RAL 9016
Bras dormant
RAL 9016
Frame hinge part
RAL 9016
No. K700G000



Flügelbandteil
RAL 9016
Bras ouvrant
RAL 9016
Door hinge blade
RAL 9016
No. K700G001



Lagerbuchse mit Hebespindel
Douille PVC avec douille filetée
Bearing bushing with lowering and lifting spindle
No. K200B0006



Lagerbolzen
Axe
Bearing pin
No. K700G0002



Befestigungsteil
Pièce de fixation
Mounting piece
No. K700K0004



Abdeckstück
RAL 9016
Cache-vis
RAL 9016
Hinge cover
RAL 9016
No. K200E0013



Bandfußunterfütterung
1,0 mm, RAL 9016
Cale
1,0 mm, RAL 9016
Packer
1.0 mm, RAL 9016
No. K700K0007



Bandfußunterfütterung
1,5 mm, RAL 9016
Cale
1,5 mm, RAL 9016
Packer
1.5 mm, RAL 9016
No. K700K0006



Bandfußunterfütterung
2,5 mm, RAL 9016
Cale
2,5 mm, RAL 9016
Packer
2.5 mm, RAL 9016
No. K700K0005



Halteschraube für Abdeckstück (klein)
Vis de fixation du cache-vis (petite)
Locking screw for cover strip (small)
No. E3300802



Gewindestift
Vis pointeau
Set screw
No. DT914M6x8/N



Stellschraube
Vis de réglage
Adjustment screw
No. K400E0001



Bohrschraube 5 x 25
Vis auto-perforante 5 x 25
Self-drilling screw 5 x 25
No. E3300803



Selbstbohrende Schraube
5,5 x 48 mm
Vis auto-perforante
Self-drilling screw
No. K700E0004



Rahmenbandteil
RAL-Farbe angeben
Bras dormant
Mentionner teinte RAL
Frame hinge part
Indicate RAL colour

Art.-Nr. auf Anfrage
No. d'article sur demande
Item no. on request



Flügelbandteil
RAL-Farbe angeben
Bras ouvrant
Mentionner teinte RAL
Door hinge blade
Indicate RAL colour

Art.-Nr. auf Anfrage
No. d'article sur demande
Item no. on request



Linsenkopfschraube 6,3x38
Vis à tête bombée 6,3x38
Rounded head screw 6,3x38

No. K650A0004



Senkkopfschraube 6,3x40
Vis fraisée 6,3x40
Counter-sunk screw 6,3x40

No. R200E0003



Sägeschutz- Lagerbolzen
Axe anti-sciage
Bearing bolt with sawing protection

No. K600B0040



Gewindestift M6x9-TX15
Vis pointeau M6x9-TX15
Set screw M6x9-TX15

No. R400E0010



Bohrschraube 5x20
Vis auto-perforante 5x20
Self-drilling screw 5x20

No. K400E0006





Rahmenbandteil
RAL-Farbe angeben
Bras dormant
Mentionner teinte RAL
Frame hinge part
Indicate RAL colour
Art.-Nr. auf Anfrage
No. d'article sur demande
Item no. on request



Flügelbandteil
RAL-Farbe angeben
Bras ouvrant
Mentionner teinte RAL
Door hinge blade
Indicate RAL colour
Art.-Nr. auf Anfrage
No. d'article sur demande
Item no. on request



Blende RBT
RAL-Farbe angeben
Cache-vis dormant
Mentionner teinte RAL
Cover frame hinge part
Indicate RAL colour
Art.-Nr. auf Anfrage
No. d'article sur demande
Item no. on request



Blende FBT
RAL-Farbe angeben
Fourreau cache-vis ouvrant
Mentionner teinte RAL
Cover wing hinge part
Indicate RAL colour
Art.-Nr. auf Anfrage
No. d'article sur demande
Item no. on request



Lagerbolzen
Axe
Bearing pin
No. K700E0100



Lagerbuchse
Douille PVC
Bearing bushing
No. K700K0100
(schwarz/noir/black)
No. K700K0103
(weiß/blanc/white)



Abdeckkappe
Capuchon
Cap hinge blade
No. K700K0102
(schwarz/noir/black)
No. K700K0105
(weiß/blanc/white)



Stopfen
Bouchon
Plug
No. K700K0101
(schwarz/noir/black)
No. K700K0104
(weiß/blanc/white)



Senkkopfschraube 6,3x40
Vis fraisée 6,3x40
Counter-sunk screw 6,3x40
No. R200E0003



Zylinderschraube M6x10
Vis à tête cylindrique M6x10
Pan head screw M6x10
No. D7984M6x10



Hebespindel
Douille fileté
Lifting and lowering spindle
No. A100G0003



Exzenter
Came
Eccentric tappet
No. K700E0101



Gewindestift M6x14
Vis pointeau M6x14
Set screw M6x14
No. K700E0102

HAHN KT-B 6R – NEUE AUSFÜHRUNG! AB MAI 2019

Nieuwe versie! Geldig vanaf mei 2019

Nouvelle version ! Depuis Mai 2019

New version Mai 2019!



Rahmenbandteil
RAL-Farbe angeben
Kaderdeel RAL kleur opgeven

Bras dormant
Mentionner teinte RAL
Frame hinge part
Indicate RAL colour

Art.-Nr. auf Anfrage
Art. Nr. op aanvraag
No. d'article sur demande
Item no. on request



Flügelbandteil
RAL-Farbe angeben
Vleugeldeel RAL kleur opgeven

Bras ouvrant
Mentionner teinte RAL
Door hinge blade
Indicate RAL colour

No. K600B0051



Blende Rahmenbandteil
RAL-Farbe angeben
Afdekstuk kaderdeel
RAL kleur opgeven

Cache-vis dormant
Mentionner teinte RAL
Cover frame hinge part
Indicate RAL colour

No. K600F0081



Abdeckstück Flügelbandteil
RAL-Farbe angeben
Afdekstuk

vleugelbandgedeelte
RAL kleur vermelden
Cache-vis bras ouvrant
Mentionner teinte RAL
Cover door hinge blade
Indicate RAL colour

No. K500F0006



Lagerbolzen komplett
Pen compleet
Axe complet
Bearing pin, complete

Art.-Nr. auf Anfrage
Art. Nr. op aanvraag
No. d'article sur demande
Item no. on request



Lagerbuchse mit Hebespindel
Bus met hoogtespindel
Douille PVC avec douille fileté
Bearing bushing with lowering and lifting spindle

No. K400B0151
(weiß/wit/blanc/white)

No. K400B0150
(schwarz/zwart/noir/black)



Halteschraube für Abdeckstück (klein)
Blokkeringschroef (klein)
Vis de fixation du cache-vis (petite)
Locking screw for cover strip (small)

No. E3300802



Abdeckkappe oben
Afdekkap boven
Capuchon supérieur
Cap, top

No. K400K0123
(weiß/wit/blanc/white)

No. K400K0124
(schwarz/zwart/noir/black)



Senkblechschraube
Verzonken schroef
Vis à tôle
Countersunk head tapping screw

No. 9000521



Bohrschraube 90°
Zelfborende schroef 90°
Vis auto-perforante 90°
Self-drilling screw 90°

No. K400E0041



Abdeckkappe / Afdekkap
Capuchon / Cap

No. EF10200380



Stopfen / Stop / Bouchon / Plug

No. K400K0008
(weiß/wit/blanc/white)

Hahn KT-B 6R mit KT-FIX / met FIX-bevestiging / avec KT-FIX / with KT-FIX



Flügelbandteil mit KT-FIX
RAL-Farbe angeben
Vleugeldeel met KT-FIX bevestiging

RAL kleur vermelden
Bras ouvrant avec KT-FIX
Mentionner teinte RAL
Door hinge blade with KT-FIX
Indicate RAL colour

No. K600B0050



Befestigungsteil mit KT-FIX
Bevestigings onderdeel met KT-FIX
Pièce de fixation avec KT-FIX
Mounting piece with KT-FIX

No. K500B0011



Bohrschraube
Zelfborende schroef
Vis auto-perforante
Self-drilling screw

No. K700E0004





Senkblechschraube
für Rahmenbandteil
Verzonken schroef kaderdeel
Vis à tôle à tête conique pour
bras dormant
*Countersunk head tapping
screw for frame hinge part*

No. K600E0001



Senkblechschraube
für Rahmenbandteil 6 x 40
*Verzonken schroef
kaderdeel 6 x 40*
Vis à tôle à tête conique pour
bras dormant 6 x 40
*Countersunk head tapping screw
for frame hinge part 6 x 40*

No. EF9000521



Abdeckstück Flügelbandteil
RAL-Farbe angeben
*Afdeksluk
vleugelbandgedeelte
RAL kleur vermelden*
Cache-vis bras ouvrant
Mentionner teinte RAL
*Cover door hinge blade
Indicate RAL colour*

No. K200G0009



Stopfen
Stop
Bouchon
Plug

No. K400K0008
(weiß/wit/blanc/white)

No. K400K0009
(schwarz/zwart/noir/black)



Halteschraube für
Abdeckstück (klein)
Blokkerings-schroef (klein)
Vis de fixation du cache-vis
(petite)
*Locking screw for cover strip
(small)*

No. E3300802

Hahn KT-B mit KT-FIX

Hahn KT-B met FIX-bevestiging

Hahn KT-B avec KT-FIX

Hahn KT-B with KT-FIX



Befestigungsteil KT-B
mit KT-FIX
*Bevestigings onderdeel KT-B
met KT-FIX*

Pièce de fixation KT-B
avec KT-FIX
*Mounting piece KT-B
with KT-FIX*

No. K600B0026



Bohrschraube 5,5 x 48 mm
Boorschroef

Vis auto-perforante
Self-drilling screw

No. K700E0004

Neue Ausführung! Ab 2017

Nieuwe versie! Geldig vanaf 2017

Nouvelle version ! Depuis 2017

New version! From 2017

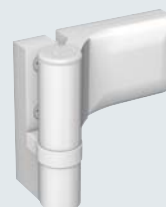

K604 ■ 0051

K604 ■ 0053

K604 ■ 0F51

K604 ■ 0F53



Lagerbuchse mit
Hebespindel
Bus met hoogtespindel

Douille PVC avec douille fileté
*Bearing bushing with lowering
and lifting spindle*

No. K200B0151
(weiß/wit/blanc/white)

No. K200B0150
(schwarz/zwart/noir/black)

Alte Ausführung! Bis 2016

Oude versie! Geldig tot 2016

Ancienne version ! Jusqu'à 2016

Old version! Valid until 2016

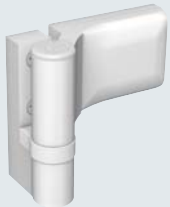

K604 ■ 0001
K604 ■ 0003
K604 ■ 0F01
K604 ■ 0F03

Neue Ausführung! Ab 2008

Nieuwe versie! Geldig vanaf 2008

Nouvelle version ! Depuis 2008

New version! From 2008



K605 ■ 0002
K605 ■ 0003
K605 ■ 0004
K605 ■ 0007
K605 ■ 0010
K605 ■ 0F02
K605 ■ 0F03
K605 ■ 0F04
K605 ■ 0F07
K605 ■ 0F10



**Lagerbuchse mit
 Hebespindel**
Bus met hoogtespindel
*Douille PVC avec
 douille filetée*
*Bearing bushing with
 lowering and lifting spindle*

No. K200B0047
 (weiß/wit/blanc/white)
No. K200B0046
 (schwarz/zwart/noir/black)



Lagerbolzen
Scharnierpen
Axe
Bearing pin
No. K200E0009



**Sägeschutz-Lagerbolzen
 komplett**
zaagbestendige pen
Axe anti-sciage complet
*Saw-resistant bearing pin,
 complete*
No. K200E0021



Abdeckkappe oben
Afdekkap boven
Capuchon supérieur
Cap, top
No. K200K0011
 (weiß/wit/blanc/white)
No. K200K0010
 (schwarz/zwart/noir/black)



Abdeckkappe oben
Afdekkap boven
Capuchon supérieur
Cap, top
No. K200K0011
 (weiß/wit/blanc/white)
No. K200K0010
 (schwarz/zwart/noir/black)



Zylinderschraube
Cylinderschroef
Vis à tête cylindrique
Pan head screw
No. K200E0011



Zylinderschraube
Cylinderschroef
Vis à tête cylindrique
Pan head screw
No. K200E0011



Adapter mit langen Stiften (vormontiert)

Embase dormant avec
tenons de centrage longs
(pré-montées)

*Adapter with long pins
(pre-assembled)*

No. K800B0001



Adapter mit kurzen Stiften (vormontiert)

Embase dormant avec
tenons de centrage courts
(pré-montées)

*Adapter with short pins
(pre-assembled)*

No. K800B0003



Bohrschraube 5,5 x 48 (Torx-Antrieb)

Vis auto-perceuse 5,5 x 48
(empreinte Torx)

*Self-drilling screw 5,5 x 48
(Torx drive)*

No. K800E0007



Gewindestift M8x10 mit Innenzweifkant

Vis pointeau M8x10
à 12 arêtes

Set screw M8x10, triple-square

No. K800E0001



RBT vormontiert

Bras dormant pré-monté

*Frame hinge part
(pre-assembled)*

No. K800B0005



Lagerbuchse weiß

Douille blanche
Bearing bushing (white)

No. K800K0005



Lagerbuchse schwarz

Douille noire
Bearing bushing (black)

No. K800K0004



FBT vormontiert (0°)

Bras ouvrant pré-monté (0°)

*Door hinge blade
pre-mounted (0°)*

No. K800B0007



FBT vormontiert (5°)

Bras ouvrant pré-monté (5°)

*Door hinge blade
pre-mounted (5°)*

No. K800B0008



Abdeckkappe weiß

Capuchon blanc
Cap (white)

No. K800K0003



Abdeckkappe schwarz

Capuchon noir
Cap (black)

No. K800K0002



Senkkopfschraube 6,3x40

Vis fraisée 6,3 x 40

Counter-sunk screw 6,3 x 40

No. R200E0003



Gewindestopfen weiß

Bouchon blanc
Screw plug (white)

No. K800K0009



Gewindestopfen schwarz

Bouchon noir
Screw plug (black)

No. K800K0008



Gewindestift DIN 913 M6x6

Vis pointeau DIN 913 M6x6

Set screw DIN 913 M6x6

No. DIN913-M6X6



Stopfen weiß

Bouchon blanc
Plug (white)

No. K800K0007



Stopfen schwarz

Bouchon noir
Plug (black)

No. K800K0006



**Adapter mit langen Stiften
(vormontiert)**

Embase dormant avec
tenons de centrage longs
(pré-montées)
*Adapter with long pins
(pre-assembled)*

No. K800B0000



**Bohrschraube 5,5 x 48
(Torx-Antrieb)**

Vis auto-perceuse 5,5 x 48
(empreinte Torx)
*Self-drilling screw 5,5 x 48
(Torx drive)*

No. K800E0007



**Gewindestift M8x10 mit
Innenzwölfkant**

Vis pointeau M8x10
à 12 arêtes
Set screw M8x10, triple-square

No. K800E0001



RBT vormontiert

Bras dormant (pré-montées)
*Frame hinge part
(pre-assembled)*

No. K800B0004



Lagerbuchse weiß

Douille noire
Bearing bushing (white)

No. K800K0005IDO



Lagerbuchse schwarz

Douille (noir)
Bearing bushing (black)

No. K800K0004IDO



FBT vormontiert (0°)

Bras ouvrant pré-monté (0°)
*Door hinge blade
pre-mounted (0°)*

No. K800B0007



FBT vormontiert (5°)

Bras ouvrant pré-monté (5°)
*Door hinge blade
pre-mounted (5°)*

No. K800B0008



Senkkopfschraube 6,3x40

Vis fraisée 6,3 x 40
Counter-sunk screw 6,3 x 40

No. R200E0003



Stopfen weiß

Bouchon blanc
Plug (white)

No. K800K0007



Stopfen schwarz

Bouchon noir
Plug (black)

No. K800K0006



RBT oben 57 mm

Bras dormant haut 57 mm
Frame hinge part, top 57 mm

No. K800F0022



Lagerbolzen

Axe
Bearing pin

No. K800G0000



Gewindestift DIN 914 M8x8

Vis pointeau DIN 914 M8x8
Set screw DIN 914 M8x8

No. DIN914M8X8A2



Gewindestift DIN 913 M6x6

Vis pointeau DIN 913 M6x6
Set screw DIN 913 M6x6

No. DIN913-M6X6



Gewindestopfen weiß

Bouchon blanc
Screw plug (white)

No. K800K0009



Gewindestopfen schwarz

Bouchon noir
Screw plug (black)

No. K800K0008



Abdeckkappe weiß

Capuchon blanc
Cap (white)

No. K800K0001



Abdeckkappe schwarz

Capuchon noir
Cap (black)

No. K800K0000



Adapterstopfen weiß

Bouchon embase blanc
Adapter plug (white)

No. K800K0011



Adapterstopfen schwarz

Bouchon embase noir
Adapter plug (black)

No. K800K0010





Adapter mit langen Stiften (vormontiert)

Embase dormant avec
tenons de centrage longs
(pré-montées)
*Adapter with long pins
(pre-assembled)*

No. K800B0001



Adapter mit kurzen Stiften (vormontiert)

Embase dormant avec
tenons de centrage courts
(pré-montées)
*Adapter with short pins
(pre-assembled)*

No. K800B0003



Bohrschraube 5,5 x 48 (Torx-Antrieb)

Vis auto-perceuse 5,5 x 48
(empreinte Torx)
*Self-drilling screw 5,5 x 48
(Torx drive)*

No. K800E0007



Gewindestift M8x10 mit Innenzölkant

Vis pointeau M8x10
à 12 arêtes
Set screw M8x10, triple-square

No. K800E0001



RBT vormontiert

Bras dormant pré-monté
*Frame hinge part
(pre-assembled)*

No. K800B0005



Lagerbuchse weiß

Douille blanche
Bearing bushing (white)

No. K800K0005



Lagerbuchse schwarz

Douille noire
Bearing bushing (black)

No. K800K0004



FBT vormontiert

Bras ouvrant pré-monté
*Door hinge blade
(pre-assembled)*

No. K800B0006



FBT Zwischenstück

Bras ouvrant
*Intermediate piece for door
hinge blade*

No. K800G0002



Zylinderschraube DIN 7984

Vis à tête cylindrique DIN 7984
Cylinder head screw DIN 7984

No. DIN7984-M6X10



Abdeckkappe weiß

Capuchon blanc
Cap (white)

No. K800K0003



Abdeckkappe schwarz

Capuchon noir
Cap (black)

No. K800K0002



Gewindestopfen weiß

Bouchon blanc
Screw plug (white)

No. K800K0009



Gewindestopfen schwarz

Bouchon noir
Screw plug (black)

No. K800K0008



Gewindestift DIN 913 M6x6

Vis pointeau M6x6
Set screw M6x6

No. DIN913-M6X6



Adapter mit langen Stiften (vormontiert)
Embase dormant avec tenons de centrage longs (pré-montées)
Adapter with long pins (pre-assembled)

No. K800B0000



Bohrschraube 5,5 x 48 (Torx-Antrieb)
Vis auto-perceuse 5,5 x 48 (empreinte Torx)
Self-drilling screw 5,5 x 48 (Torx drive)

No. K800E0007



Gewindestift M8x10 mit Innenzölkant
Vis pointeau M8x10 à 12 arêtes
Set screw M8x10, triple-square

No. K800E0001



RBT vormontiert
Bras dormant pré-monté
Frame hinge part (pre-assembled)

No. K800B0004



Lagerbuchse weiß
Douille blanche
Bearing bushing (white)

No. K800K0005IDO



Lagerbuchse schwarz
Douille noire
Bearing bushing (black)

No. K800K0004IDO



FBT vormontiert
Bras ouvrant pré-monté
Door hinge blade (pre-assembled)

No. K800B0006



FBT Zwischenstück
Bras ouvrant
Intermediate piece for door hinge blade

No. K800G0002



Zylinderschraube DIN 7984
Vis à tête cylindrique DIN 7984
Cylinder head screw DIN 7984

No. DIN7984-M6X10



RBT oben 57 mm
Bras dormant haut 57 mm
Frame hinge part, top 57 mm

No. K800F0022



Lagerbolzen
Axe
Bearing pin

No. K800G0000



Gewindestift DIN 914 M8x8
Vis pointeau DIN 914 M8x8
Set screw DIN 914 M8x8

No. DIN914M8X8A



Gewindestift DIN 913 M6x6
Vis pointeau DIN 913 M6x6
Set screw DIN 913 M6x6

No. DIN913-M6X6



Gewindestopfen weiß
Bouchon blanc
Screw plug (white)

No. K800K0009



Gewindestopfen schwarz
Bouchon noir
Screw plug (black)

No. K800K0008



Abdeckkappe weiß
Capuchon blanc
Cap (white)

No. K800K0001



Abdeckkappe schwarz
Capuchon noir
Cap (black)

No. K800K0000



Adapterstopfen weiß
Bouchon embase blanc
Adapter plug (white)

No. K800K0011



Adapterstopfen schwarz
Capuchon noir
Adapter plug (black)

No. K800K0010





Notes
Notes

A large grey rectangular area containing horizontal lines for writing notes.

Notes

Notes

A large grey rectangular area containing horizontal lines for writing notes. The lines are evenly spaced and extend across the width of the grey area.



Dr. Hahn GmbH & Co. KG

Trompeterallee 162 – 170 · D-41189 Mönchengladbach
Postfach 400109 · D-41181 Mönchengladbach
Phone +49(0)2166 954-3 · E-Mail: sales@dr-hahn.com
www.dr-hahn.eu