

PREISLISTE 2024

UNIVERSAL-ABGASSYSTEME / SCHÄCHTE

- für Gas-, Methanol- und Öl-Brennwertkessel
- für Blockheizkraftwerke (BHKW)
- für Brennstoffzellen
- für Gaswärmepumpen
- Universelle Abgaswärmetauscher
- Abgas-Schalldämpfer
- Wärmepumpen, Schallhauben und Tieftemperatur-Heizkörper



eHEAT

Wärmepumpe 8,5 und 12,5 kW

- Monoblock: einfache Installation
- 8,5 oder 12,5 kW Leistung
- integrierter Speicher
- perfekte Integration in Hybridkonzepte
- Regelmöglichkeiten z.B. mit WIFI oder **eCONTROL**
- leiser als 50 dB(A)

Weitere Infos im ↗ Prospekt
Wärmepumpen
Artikel-Nr. 10003014



Wärmepumpen und passendes
Zubehör ↗ Preisliste Wärmepumpen
Artikel-Nr. 10001483

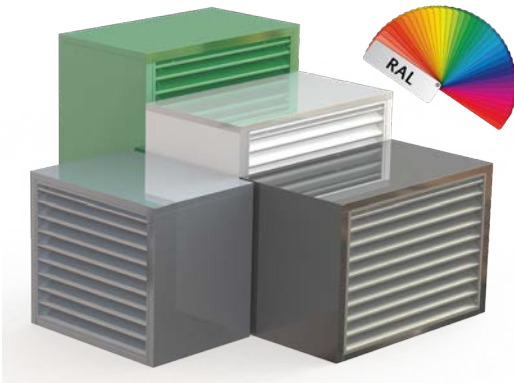

Weitere Infos in der ↗ Preisliste
Schallhauben Artikel-Nr. 10001488

eSILENT

Schallhauben für Wärmepumpen, Klima- und Kälteanlagen

- bis zu -16 dB(A) Schallreduktion
- Schutz vor Vandalismus und Wetter
- hochwertige Materialien
- einfache Montage
- individuelle Fertigung
- auf Wunsch in RAL-Farbe nach Wahl

Weitere Infos im ↗ Prospekt
Schallhauben Artikel-Nr. 10003130



eVENT

Tieftemperatur-Heizkörper

- integrierte Ventilatoren
- automatische Regelung
- für niedrige Vorlauftemperaturen

Weitere Infos im ↗ Prospekt
Tieftemperatur-Heizkörper
Artikel-Nr. 10001310

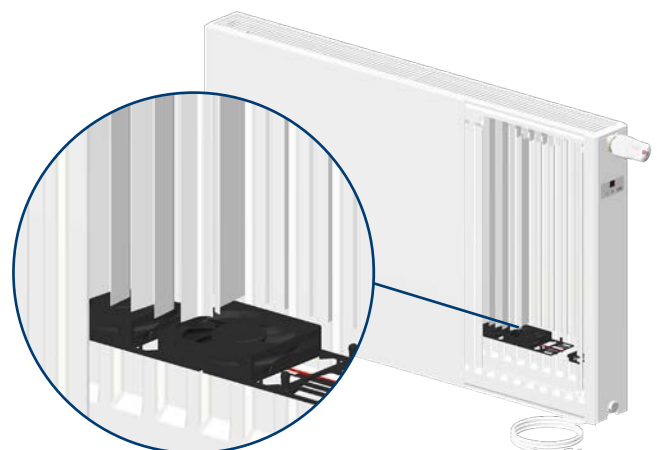

Weitere Infos in der ↗ Preisliste
Tieftemperatur-Heizkörper
Artikel-Nr. 10001482

Ihre Konditionen für Preisgruppen:

Preisgruppe 10	Preisgruppe 11	Preisgruppe 12	Preisgruppe 13	Preisgruppe 15	Preisgruppe 16	Preisgruppe 17	Preisgruppe 18

INHALTSVERZEICHNIS

ATEC | ABGASSYSTEME

	Seite
PRODUKTÜBERSICHT	4 – 5
ZULASSUNGEN	6
EINWANDIGE – ABGASSYSTEME	7 – 15
DN 60 bis DN 250 PolyTop	
KONZENTRISCHE – ABGASSYSTEME	16 – 23
DN 60/100 bis DN 110/160 PolyClassic PolyTwin	
AUßENWAND – ABGASSYSTEME	24 – 33
DN 60/100 bis DN 250/315 IronPoly WhitePoly	
KASKADEN – ABGASSYSTEME	34 – 37
für den Anschluss von bis zu 10 Feuerstätten im gleichen Aufstellraum	
MEHRFACHBELEGUNG – ABGASSYSTEME	38 – 45
für den Anschluss von bis zu 10 Feuerstätten in unterschiedlichen Etagen	
ABGAS – SCHACHT – SYSTEME	46 – 51
DN 60 bis DN 250 PolyCase 150 x 200 bis 420 x 420 mm Außenmaß	
ABGAS – WÄRMETAUSCHER – SYSTEME	52 – 53
GPH AK 28 eMAX GPH HP 28	
SCHALLDÄMPFER EDELSTAHL-ABGASSYSTEM	54
Siehe separate Preislisten	
KESSELBEZOGENE ABGASLEITUNGSBEMESSUNGEN	55 – 69
MAßTABELLE BAUTEILE	70 – 71

PRODUKTÜBERSICHT

ATEC | ABGASSYSTEME

EINWANDIGE – ABGASSYSTEME

7 – 15

DN 60 bis DN 250

PolyTop

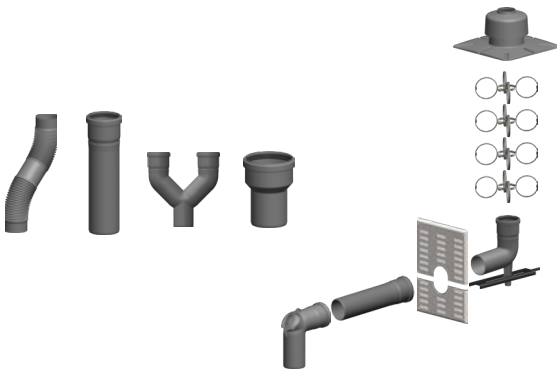

Schacht-Sets	7
einwandige Bauteile	10
Zubehör	12
Reduktionen und Erweiterungen	14

KONZENTRISCHE – ABGASSYSTEME

16 – 23

DN 60/100 bis
DN 110/160

PolyClassic PolyTwin

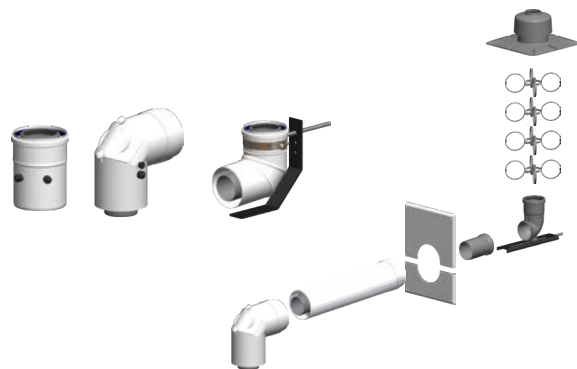

Schacht-Sets	16
konzentrische Bauteile	18
Zubehör	20
Kesselanschlüsse	21
Mündungselemente und Zubehör	22

AUßENWAND – ABGASSYSTEME

24 – 33

DN 60/100 bis
DN 250/315

IronPoly WhitePoly



Edelstahl weiß DN 60/100 bis DN 110/160	24
Edelstahl blank DN 60/100 bis DN 110/160	26
Edelstahl blank DN 125/190 bis DN 250/315	28
Sonstiges	30
Sonderoberflächen	32

KASKADEN – ABGASSYSTEME

34 – 37

für den Anschluss von bis zu 10 Feuer-
stätten im gleichen Aufstellraum

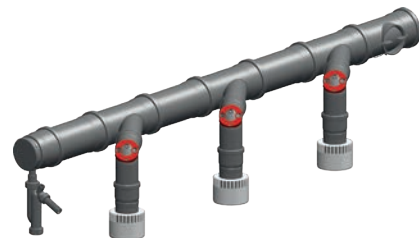

Einwandig	34
Konzentrisch DN 80/125 bis DN 110/160	35
Konzentrisch DN 125/190 bis DN 200/265	36

PRODUKTÜBERSICHT

ATEC | ABGASSYSTEME

MEHRFACHBELEGUNG – ABGASSYSTEME

38 – 45

für den Anschluss von bis zu 10 Feuerstätten in unterschiedlichen Etagen



im vorhandenen Schacht DN 100, 125 und 160.....	38
im vorhandenen Schacht DN 80 und DN 110	40
im Brandschutzschacht PolyBit DN 100, 125 und 160.....	42
im Brandschutzschacht PolyBit DN 80 und DN 110.....	43
an der Fassade	44

ABGAS – SCHACHT – SYSTEME

46 – 51

DN 60 bis DN 250
150 x 200 bis 420 x 420 mm Außenmaß

PolyCase

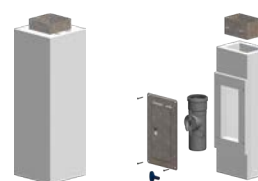

L _A 30	46
L _A 90	48

ABGAS – WÄRMETAUSCHER – SYSTEME

52 – 53

GPH AK 28
GPH HP 28



Wärmetauscher GPH AK 28	52
Wärmetauscher GPH HP 28	53
Zubehör	53

DATEN UND BERECHNUNGEN

56 – 71

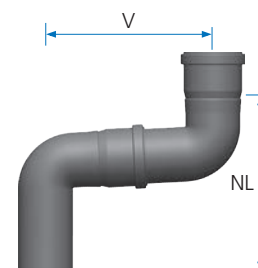
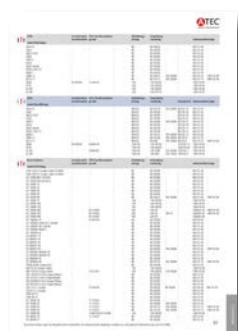

ABGAS – SCHALLDÄMPFER – SYSTEME

54



ABGASSYSTEME – EDELSTAHL

54



Formular zur Querschnittsberechnung	55
Kesselbezogene Abgasleitungsdimensionen	56
Maßtabelle Einwandiges Abgassystem.....	70

Anwendungsmöglichkeiten:

- Öl-, Methanol- und Gas-Brennwertfeuerstätten
- Brennwertfeuerstätten der Geräteart B (raumluftabhängig)
- Brennwertfeuerstätten der Geräteart C₆, C₈ und C₍₁₀₎ (raumluftunabhängig)
- Abgaswärmetauscher
- BHKW
- Gaswärmepumpen
- Brennstoffzellen

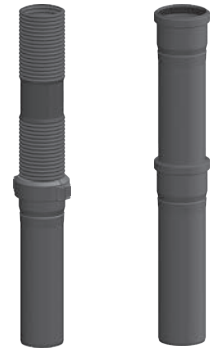

Zulassungen/ Allgemeine Bauartgenehmigungen:

- CE 0036 CPD 91265-001
- Z-7.5-3356 Luft-Abgas-System/Mehrfachbelegung
- Z-7.4-3396 Schachtsystem PolyCase 25 mm Wanddicke (L_A30) und 40 mm Wanddicke (L_A90)
- Z-7.4-3533 Schachtsystem PolyBit 50 mm Wanddicke (L_A90)
- Z-7.1-3538 Abgaskaskade BHKW und Kessel mit Rückstromsicherung
- Z-43.31-222 GPH AK und HP Abgaswärmetauscher

Werkstoff:

Alle Abgas berührten Bauteile sind aus kondensat- und witterungsbeständigem PP (Polypropylen) hergestellt und für Abgastemperaturen bis 120°C zugelassen.

Verbindungstechnik:

Die Verbindung der Bauteile erfolgt mittels Steckmuffen. Spezielle Elastomer-Dichtungen sorgen für sichere und schnelle Montage. Diese 3-lippigen Dichtungen sind beständig gegen alle Öl- und Gaskondensate aus Brennwertfeuerstätten.

Stopping-Technik:

Die Stopping-Technik erhöht die Auszugsfestigkeit der Muffenverbindungen bei der Montage. Rohre in 2 m Baulängen der Durchmesser DN80 und 100 sind ab Werk mit dem ATEC-Stopping ausgerüstet.

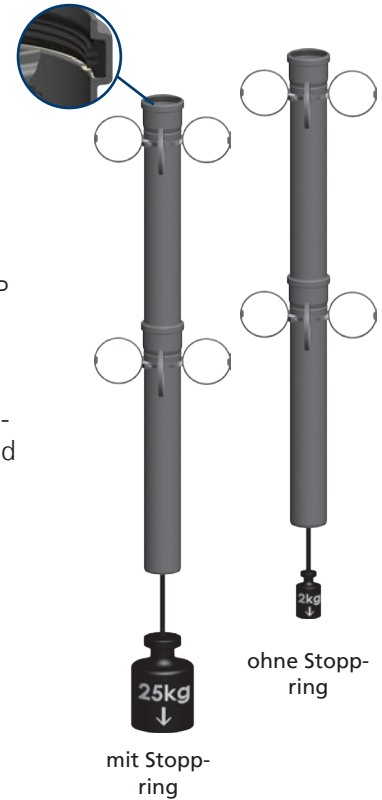

Klassifizierung und Kennzeichnung

EN 14471	T120	H1	W	2	O20	LI	E	U
Norm								
max. Abgastemperatur								
	Überdruck bis 5000 Pa = H1							
	Überdruck bis 1500 Pa = M1							
	Überdruck bis 200 Pa = P1							
	feuchte Betriebsweise							
	Korrosionswiderstandsklasse Gas + Heizöl bis 0,2% Schwefelgehalt							
	Bauteile einwandig Abstand zu brennbaren Baustoffen = 20 mm							
	Bauteile doppelwandig Abstand zu brennbaren Baustoffen = 0 mm							
	Einbau der Abgasanlage im Schacht oder Schutzrohr = LI							
	Einbau der Abgasanlage in/oder außerhalb des Gebäudes = LE							
						schlechtes Brennverhalten		
							Konstruktion ohne Ummantellung = U	
							Konstruktion mit brennbarer Ummantellung = U1	
							Konstruktion mit nicht brennbarer Ummantellung = U0	

EINWANDIGE

ATEC | ABGASSYSTEME

EINWANDIG

SV-SCHACHT-SETS

PolyTop

SV-Schacht-Set

- (1) SV-Bogen
- (2a) Adapter Stützrohr universell (verlängerbar mit Rohr DN80)
- (2b) SV-Auflager (⚠ nur für DN60 und DN80)
- (3) Schraubstützen kürzbar, 1000 mm
- (4) Abstandhalter 4x für VA-Sanierung
- (5) Mündungs-Set Kunststoff inkl. Befestigung

DN 60	0373 €154
DN 80	1373 €187
DN 100	2373 €269
DN 110	3373 €302

Mit dem SV-Schacht-Set kann die vorhandene Edelstahl-Abgasanlage einfach und ohne Öffnen saniert und damit nachhaltig wiederverwendet werden.

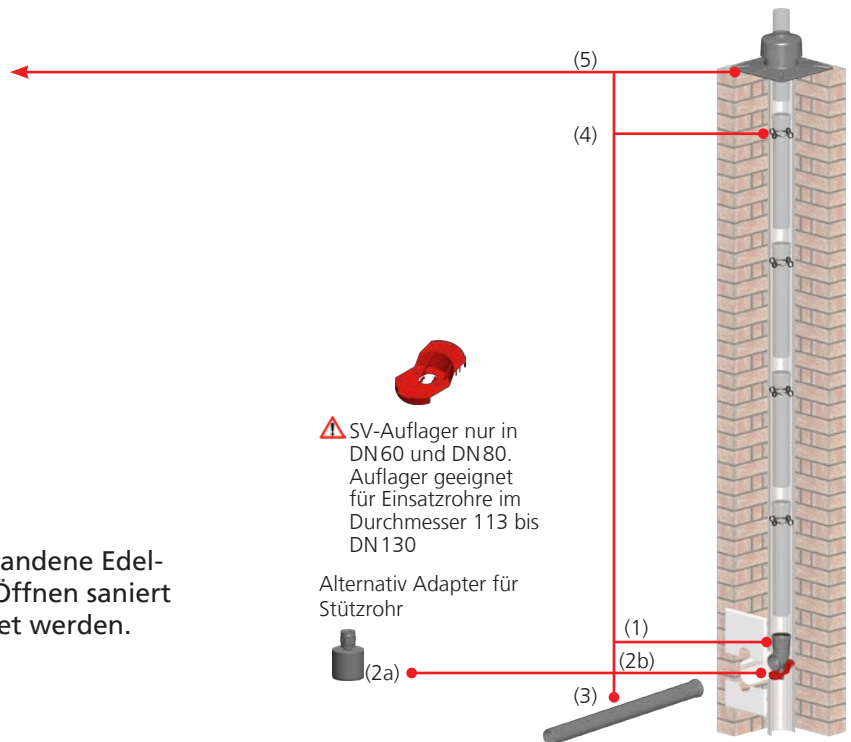

ERWEITERUNGSOPTIONEN AUßENWAND

	DN 60	DN 80	DN 100	DN 110
Regenabweiser Edelstahl, 100 mm	990080 €42	990081 €42	990082 €45	990083 €46
Regenabweiser Edelstahl, 150 mm	990090 €54	990091 €54	990092 €62	990093 €69
Zentrierung Endrohr DW-Schornstein	990140 €115	990141 €118	990142 €127	990143 €133
Endrohr Edelstahl, 450 mm	990111 €53	990102 €54	990103 €55	990112 €57

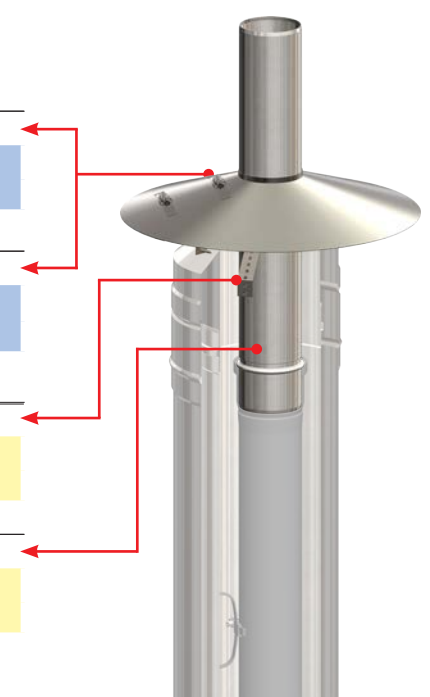

Ergänzt man das obige SV-Schacht-Set um die universelle Endrohr-Zentrierung und den Regenabweiser, so kann einfach und nachhaltig eine vorhandene Edelstahl-Außenwand-Abgasanlage saniert werden. Aus optischen Gründen kann alternativ auch ein Edelstahl-Endrohr verbaut werden.

EINWANDIGE

ATEC | ABGASSYSTEME

Schacht-Set inkl. Verbindungsleitung

- (1) Zuluftgitter
- (2) 87°-Kontroll-Bogen
- (3) Rohr 500 mm
- (4) Wandblende mit Hinterlüftung
- (5) Schachteinführung mit Auflager
- (6) Abstandhalter 4x
- (7) Mündungs-Set Kunststoff inkl. Befestigung

PolyTop PP-Abgassystem

D 60 - DN 60	0370 € 197
D 80 - DN 80	1370 € 250
D 100 - DN 100	2372 € 346
D 110 - DN 110	3370 € 395

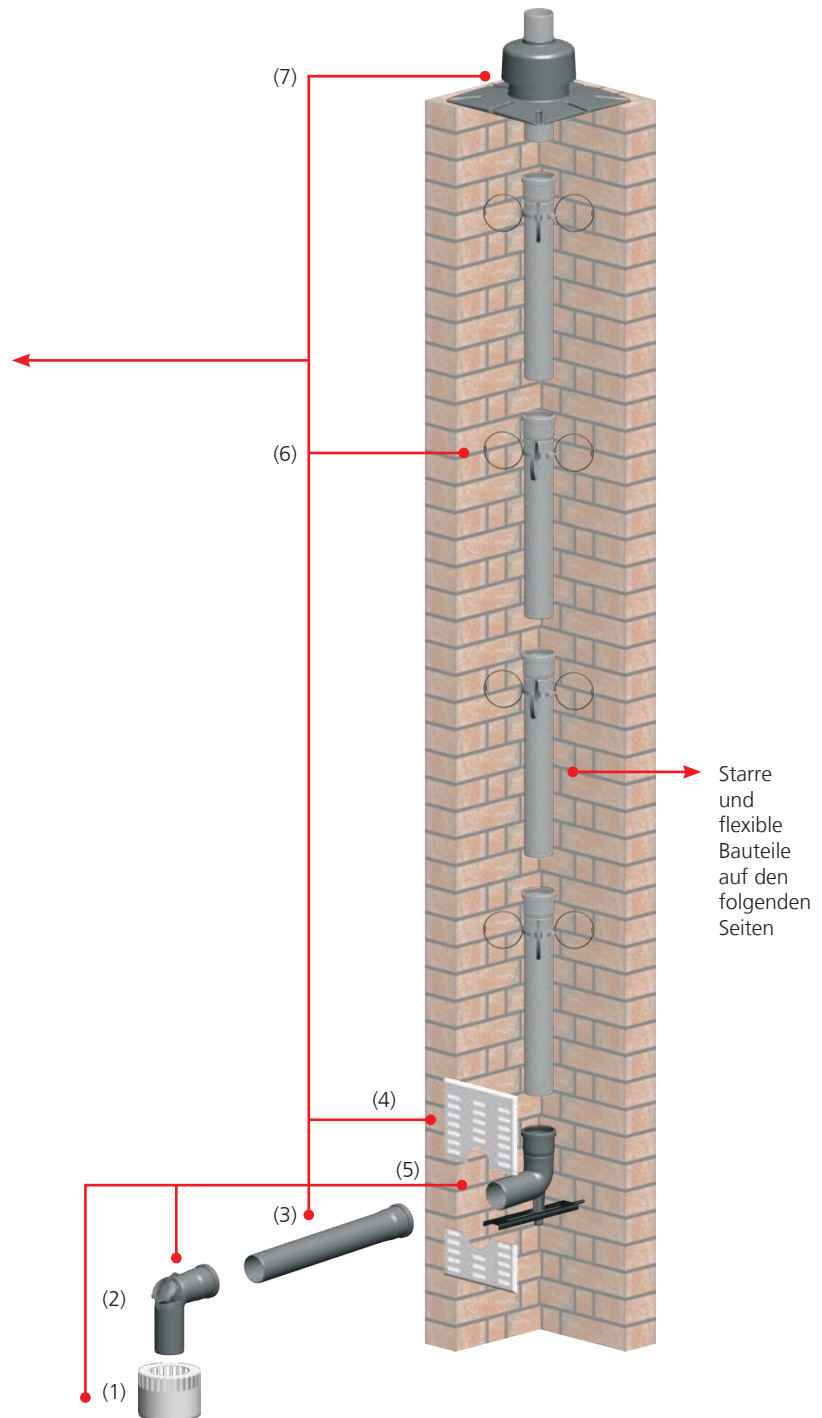

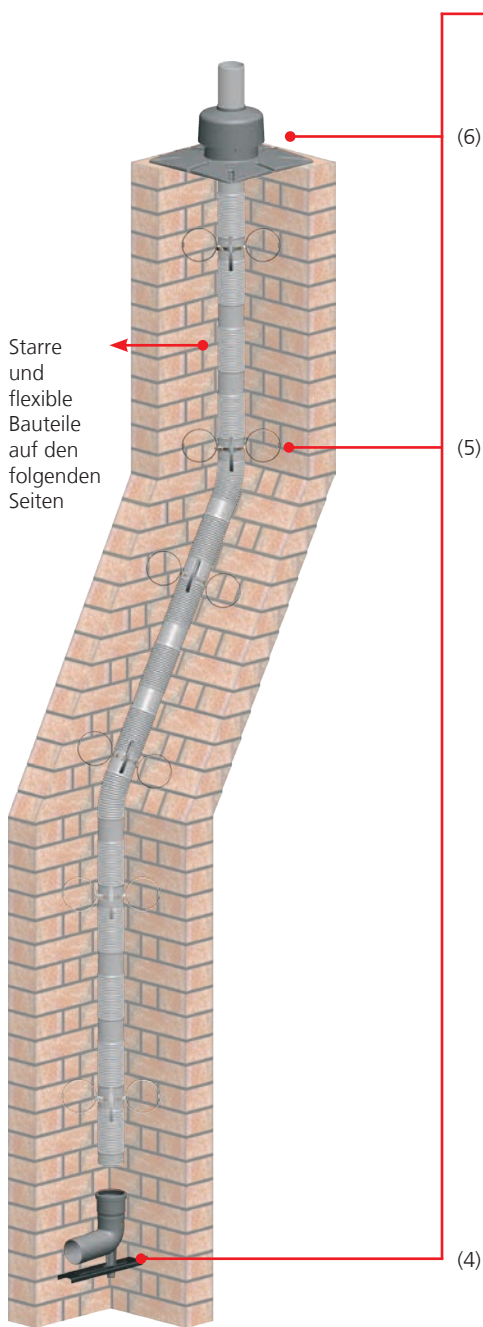

Schacht-Set mit Mündung aus Kunststoff
(4) Schachteinführung mit Auflager
(5) Abstandhalter 4x
(6) Mündungs-Set Kunststoff inkl. Befestigung

PolyTop	PP-Abgassystem
D 60 - DN 60	0371 €123
D 60 - DN 80	0372 €135
D 80 - DN 80	1371 €171
D 80 - DN 100	1372 €201
D 100 - DN 100	2371 €212
D 110 - DN 110	3371 €281
D 125 - DN 125	4371 €341
D 160 - DN 160	6371 €404

Mündungs-Set
Edelstahl siehe
Seite 12

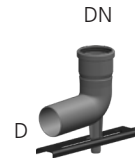

Schacht-Set mit Mündung aus Kunststoff
(4) 87°-Bogen mit Schachteinführungsstütze ohne Auflager
(5) Abstandhalter 4x
(6) Mündungs-Set Kunststoff inkl. Befestigung

PolyTop	PP-Abgassystem
D 200 - DN 200	8371 €488
D 250 - DN 250	9371 €944

Mündungs-Set
Edelstahl siehe
Seite 12

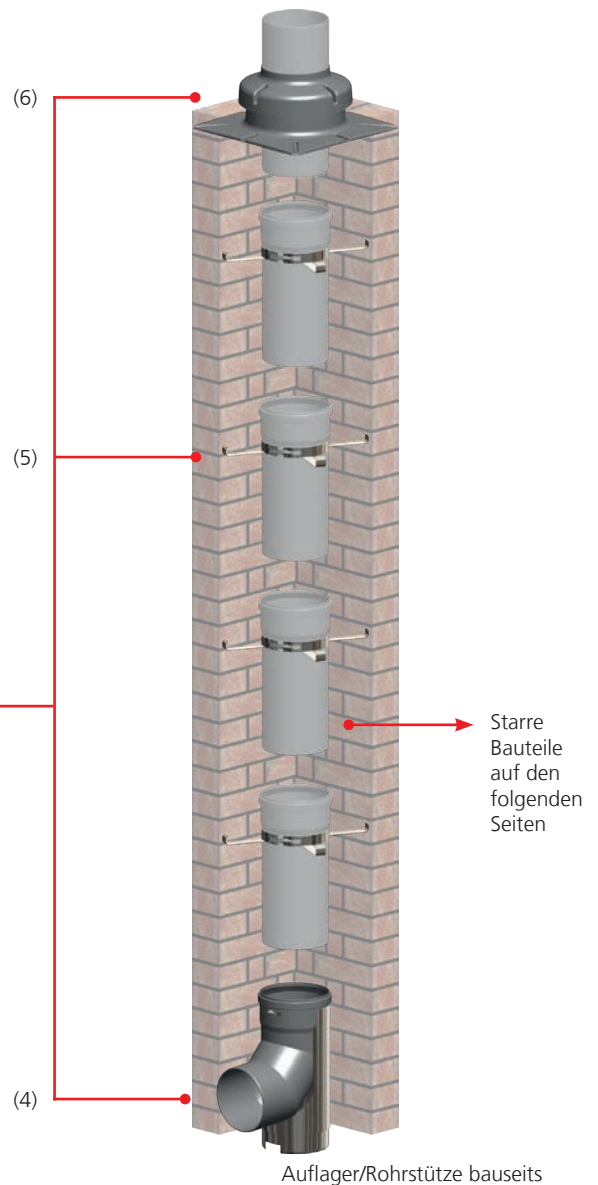

DN 60 DN 80 DN 100 DN 110 DN 125 DN 160 DN 200 DN 250

SV-Schachteinführung, schraubbar mit Auflager (für kleine Schächte)



0347 €73	1347 €77	2347 €110	3347 €127
--------------------	--------------------	---------------------	---------------------



[Link zum Video](#)

SV-Auflager für Edelstahl Rohr 113-130mm (5 Stück)



1383 €74

Schachteinführung mit Auflager

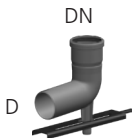

DN	D = DN	0334 €40	1334 €63	2334 €85	3334 €110	4334 €123	6334 €155	8334 €174	9334 €352
D			0336 €53	1336 €72					
			D 60	D 80					



Ab DN 200 mit Schachteinführungsstütze (ohne Auflager).

87°-Kontroll-Bogen



0301 €26	1301 €35	2301 €49	3301 €95	4301 €118	6301 €133	8301 €155	9301 €300
--------------------	--------------------	--------------------	--------------------	---------------------	---------------------	---------------------	---------------------

Kontroll-Rohr



	0303 €26	1303 €32	2303 €43	3303 €59	4303 €86	6303 €118	8303 €123	9303 €268
Nutzlänge	147 mm	190 mm	210 mm	230 mm	215 mm	261 mm	366 mm	434 mm

30°-Bogen



0314 €14	1314 €18	2314 €24	3314 €39	4314 €44	6314 €85	8314 €123	9314 €187
--------------------	--------------------	--------------------	--------------------	--------------------	--------------------	---------------------	---------------------

45°-Bogen



0315 €14	1315 €18	2315 €24	3315 €39	4315 €44	6315 €85	8315 €123	9315 €205
--------------------	--------------------	--------------------	--------------------	--------------------	--------------------	---------------------	---------------------

87°-Bogen



0316 €17	1316 €20	2316 €29	3316 €41	4316 €47	6316 €85	8316 €142	9316 €268
--------------------	--------------------	--------------------	--------------------	--------------------	--------------------	---------------------	---------------------

Rohr, kürzbar



Nutzlänge	255 mm	0317 €13	1317 €13	2317 €20	3317 €22	4317 €25	6317 €39		
	360 mm							8317 €47	9317 €103
	500 mm	0318 €14	1318 €20	2318 €26	3318 €28	4318 €35	6318 €47	8318 €79	9318 €123
	955 mm	0319 €18	1319 €26	2319 €33	3319 €49	4319 €51	6319 €70	8319 €101	9319 €187
	1.955 mm	0320 €28	1320 €41	2320 €54	3320 €74	4320 €82	6320 €108	8320 €174	9320 €269

Langmuffe



	0324 €26	1324 €29	2324 €38	3324 €44
Nutzlänge	80 - 190 mm			

	DN 60	DN 80	DN 100	DN 110	DN 125	DN 160	DN 200	DN 250
--	-------	-------	--------	--------	--------	--------	--------	--------

Kondensatablauf mit Siphon, bis 1000 Pa Überdruck geeignet



	0348 €54	1348 €53	2348 €64	3348 €90	4348 €90	6348 €123	8348 €155	9348 €236
Nutzlänge	137 mm	137 mm	137 mm	137 mm	161 mm	131 mm	199 mm	395 mm
Für höhere Drücke anderer Siphon auf Anfrage								

87°-Siphonanschluss für Kondensatablauf



601349
€21

Messelement/Kesselanschluss



	0115 €35	1115 €33	2115 €44	3115 €56	4115 €60	6115 €75	8115 €77	9115 €110
--	--------------------	--------------------	--------------------	--------------------	--------------------	--------------------	--------------------	---------------------

Flexrohr-Set bestehend aus:

Anzahl Montage-Set: ()



10 m	10322 (1) €279	11322 (1) €400	12322 (1) €609					
12,5 m	20322 (1) €354	21322 (1) €512	22322 (1) €759					
15 m	30322 (1) €421	31322 (1) €613	32322 (1) €906	33322 (1) €906	34322 (1) €1160	36322 (1) €1606		
20 m				53322 (1) €1186	54322 (1) €1549	56322 (1) €2142		

75 m	90322 (6) €1717	91322 (5) €1655	92322 (3) €2760	83322 (0) €1972	84322 (0) €2323	86322 (0) €3213	← Ohne Montageset.
------	---------------------------	---------------------------	---------------------------	---------------------------	---------------------------	---------------------------	---------------------

Montage-Set für Rohr flexibel bestehend aus:



- Mündungsendstück
- Aufhängung
- Fixschellen
- Hülse

	0327 €50	1327 €50	2327 €50	3327 €64	4327 €155	6327 €187
--	--------------------	--------------------	--------------------	--------------------	---------------------	---------------------

Rohr flexibel, Sonderlänge per m; Lieferzeit 1 - 4 Tage



	0322 €33	1322 €49	2322 €60	3322 €60	4322 €77	6322 €105
--	--------------------	--------------------	--------------------	--------------------	--------------------	---------------------



Je Sonderlänge wird ein Montage-Set benötigt.



Von DN 125 und DN 160 müssen mindestens 12 m bestellt werden.

Einzugshilfe für Rohr flexibel



	0382 €53	1382 €55	2382 €58	3382 €69
--	--------------------	--------------------	--------------------	--------------------

Kupplung für Rohr flexibel und starres Rohr (bei Edelstahl Mündungs-Set oder zur Verbindung von flexiblen Leitungsabschnitten erforderlich)



	0351 €54	1351 €82	2351 €111	3351 €111	4351 €131	6351 €154
--	--------------------	--------------------	---------------------	---------------------	---------------------	---------------------

Kontroll-Rohr für Rohr flexibel (mit Stockanker)















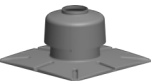

	0304 €86	1304 €127	2304 €153
Nutzlänge	81mm	117 mm	139 mm

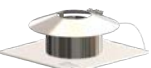
Kontroll-Rohr für Rohr flexibel (inklusive Befestigungsset)



	3304 €171	4304 €235	6304 €267
Nutzlänge	172 mm	156 mm	170 mm

	DN 60	DN 80	DN 100	DN 110	DN 125	DN 160	DN 200	DN 250
Abstandhalter	Preis für 4 Stück				ab DN 125 Preis per Stück			
	0354 €38	1354 €49	2354 €51	3354 €52	6352 €24	8352 €32	9352 €43	
								ab DN 200 aus Edelstahl
Abstandhalter für *große Schächte								
	0353 €52	1353 €54	2353 €88	3353 €60	4353 €62	6353 €63	8353 €72	9353 €76
* max.lichte Weite in mm	580	580	600	600	620	650	700	750
Abstandhalter Stern (10 Stück)								
	0357 €90	1357 €96		3357 €105				
 Nur für starre Rohre.								
Kleine Abstandhalter für VA Sanierung (4 Stück)								
	1358 €52							
Mündungs-Set Kunststoff (inkl Befestigungs-Set)								
	360 x 360 mm	0338 €59	1338 €89	2338 €104	3338 €122			
	400 x 400 mm				4338 €131	6338 €163		
	440 x 440 mm						8338 €212	
	500 x 500 mm							9338 €277
Mündungs-Set Edelstahl mit Endrohr 450 mm , erforderlich bei neben angeordneten und in Betrieb befindlichen Festbrennstoffzügen!								
	330 x 330 mm	0342 €198	1342 €232	2342 €269	3342 €292			
 Kupplung (siehe Seite 11) bei Rohr flexibel notwendig.								
Zuluftverschluss Edelstahl , passend für Mündungs-Set Edelstahl								
	305 x 305 mm	990049 €64	990050 €64	990051 €64	990052 €64			
Mündungs-Set Edelstahl								
	400 x 400 mm				4342 €198	6342 €226	8342 €277	9342 €350
 Kupplung (siehe Seite 11) bei Rohr flexibel notwendig.								ab DN 200 440 x 440 mm
Endrohr Edelstahl , erforderlich bei neben angeordneten und in Betrieb befindlichen Festbrennstoffzügen!								
	450 mm	990111 €53	990102 €54	990103 €55	990112 €57	4344 €83	Festbrennstoffzugerhöhungen siehe Seite 20	
	940 mm	990117 €83	990028 €84	990029 €87	990045 €98		6344 €117	8344 €133
							9344 €151	
Wandblende mit Hinterlüftung für raumluftabhängigen Betrieb								
	280 x 350 mm	0330 €46	1330 €61	2330 €61				
Wandblende mit Hinterlüftung für raumluftabhängigen Betrieb								
	280 x 340 mm				3330 €59	4330 €61	6330 €67	
	350 x 350 mm						8330 €100	9330 €122
Zuluftgitter								
	DN	0590 €30	1590 €36	2590 €41	3590 €47			
D	D100	D125	D150	D160				

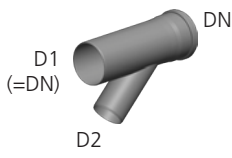
	DN 60	DN 80	DN 100	DN 110	DN 125	DN 160	DN 200	DN 250
Abzweig 42°								
				603308 €103	604319 €109			
D2 60								
D2 80	601316 €89	602316 €103	603316 €103	604316 €123	606318 €154	608318 €214		
D2 100			602317 €116	603317 €116	604317 €116	606317 €194	608317 €214	609318 €227
D2 110				603322 €121	604318 €129	606319 €195	608321 €231	609321 €263
D2 125					604312 €159	606320 €195	608316 €250	609316 €293
D2 160						606322 €224	608319 €289	609317 €322
D2 200							608322 €344	609319 €325
D2 250								609320 €386

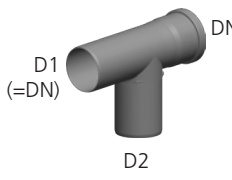
	DN 60	DN 80	DN 100	DN 110	DN 125	DN 160	DN 200	DN 250
T-Stück								
								
D2 60	600303 €50	601301 €73	602301 €62		604301 €101	606301 €122		
D2 80		601303 €50	602302 €62	603305 €97	604304 €121	606303 €123	608301 €159	
D2 100			602303 €55		604305 €126	606308 €159	608302 €159	
D2 110				603303 €115	604309 €134	606312 €129	608311 €235	
D2 125					604303 €134	606321 €160	608304 €143	609303 €269
D2 160						606310 €156	608309 €168	609304 €269
D2 200							608310 €267	609305 €289
D2 250								609310 €321

 Weitere Ausführungen auf Anfrage.

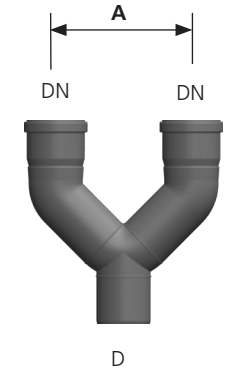
	DN 60	DN 80	DN 100	DN 110	DN 125	DN 160	DN 200	DN 250
Hosenformteil Lieferzeit 2 - 4 Tage								
								
D 60	600301 €112							
D 80	600307 €105	601308 €121						
D 100	600308 €121	602307 €144	602308 €155					
D 110	603306 €178	603307 €159	602306 €177	603302 €201				
D 125		604311 €205	604307 €201	603304 €278	604308 €284			
D 160		606313 €299	606306 €325	606309 €364	606307 €364			
D 200		608306 €295	608312 €308	608305 €338	608308 €353	608307 €403		
D 250					609307 €511	609306 €511	609308 €491	

 **Maß A muss bei der Bestellung angegeben werden!**
Bei Bestellung von Hosenformteilen wird der Achsabstand (A) der beiden Schächte (Mitte/Mitte) benötigt. Bereits bei der Planung muss die Abstimmung mit dem bevollmächtigten Bezirksschornsteinfeger erfolgen. Weitere Ausführungen auf Anfrage.



Achsabstand **A**= mm

		DN 60	DN 80	DN 100	DN 110			DN 125	DN 160	DN 200	DN 250
Reduktion/Erweiterung zentrisch											
 DN D	D 60		1137 €35		3103 €129			4105 €124			
	D 63		1138 €35					4108 €124	6105 €122		
	D 70		1139 €35					4112 €124			
	D 75	0140 €65	1140 €35	1143 €47					6111 €124		
	D 80	0130 €32		1146 €43	3150 €61			4106 €124	6114 €159		
	D 100		1141 €38		3151 €59			4101 €118	6117 €154		
	D 110		1142 €43	2232 €51				4104 €118			
	D 125			2102 €77	3101 €77			4111 €188	6102 €150		
	D 150			2101 €142	3104 €150			4113 €161	6103 €155		9106 €270
	D 160				3105 €97				6112 €155	8102 €155	
D 200				3106 €189							

 Weitere Übergänge in Vorbereitung/auf Anfrage.

Reduktion/Erweiterung exzentrisch											
 D	D 60		1157 €40	2104 €70				4109 €77	6116 €144		
	D 63		1158 €40					4102 €77	6107 €142		
	D 70		1159 €40					4103 €77	6113 €122	8109 €122	
	D 75		1160 €47						6104 €122	8108 €122	9108 €179
	D 80			1166 €55	3102 €82				6106 €142		
	D 100				1168 €82				6101 €133		
	D 110		1162 €38							8107 €142	9102 €186
										8103 €155	
									6118 €155		9101 €187
											9107 €308

 Weitere Übergänge in Vorbereitung/auf Anfrage.

Vario-Stopfen für Emissionsmessung



Ø 11 mm

169921
€7

Gleitmittel 150 g Tube

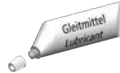

160000
€10

Kondensatbox für Gas-Brennwert, inklusive Füllung



bis 30 kW

601129
€144



bis 35 kW

601285
€285

bis 65 kW

601286
€334



bis 150 kW

601287
€477

bis 300 kW

601288
€635

Kondensatbox für Öl-Brennwert, inklusive Füllung



bis 30 kW

601129
€144



bis 35 kW

601292
€495

bis 50 kW*

* bei schwefelarmen Öl

Nachfüllgranulat zu 601129



1,4 kg

169964
€20

Nachfüllgranulat zu 601285 bis 601292



2 x 1,3 kg

601296
€70

5 kg

601297
€122

Aktivkohle

2 x 250 g

601298
€84

**Einzughilfe Flexrohr für SV Schacht-
verschraubung bis DN110**



601382
€26

Adapter Stützrohr



601483
€36

Wasserwaage



1050068
€30

DN 60 DN 80 DN 100 DN 110 DN 125 DN 160 DN 200 DN 250

3-fach Lippendichtung



160380
€5

161380
€6

162380
€9

163380
€9

164380
€12

166380
€15

168380
€17

169380
€20

Haubentop für Dachhochführung als Ersatzteil



ziegelrot

160366
€24

161366
€25

schwarz

160365
€24

161365
€25

Mündungshaube für Abdeckplatte als Ersatzteil

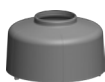

schwarz

160364
€25

161364
€26

162364
€30

163364
€43

Dichtung für Kontroll-Bauteile



160381
€6

161381
€6

162381
€6

163381
€5

166381
€8

168381
€13

169381
€20

KONZENTRISCHE

A TEC | ABGASSYSTEME

Schacht-Set inkl. Verbindungsleitung mit Mündung aus Kunststoff und SV-Schachteinführung

- (1) 87°-Kontroll-Bogen
- (2) Rohr 500 mm
- (3) Wandblende geschlossen
- (4) SV-Schachteinführung mit Auflager
- (5) Abstandhalter 4x
- (6) Mündungs-Set Kunststoff 360 x 360 mm inkl. Befestigung

PolyClassic PP-Abgassystem/Stahl weiß

DN 80/125 - DN 80 **1473**
€384

PolyTwin PP-Abgassystem/PP-weiß

DN 60/100 - DN 60 **0573**
€281

DN 80/125 - DN 80 **1573**
€382

Ihr Kostensenker, nur Original von ATEC

Die SV-Schachteinführung reduziert ihre Stemmarbeit, Maurer- und Verputzarbeit, erspart Ihnen ggf. den Ausbau von Sanierungsrohren und mindert oder verhindert die Einsturzgefahr von Innenschalen mehrschaliger Schornsteinsysteme. Eine Kernbohrung reicht.

Wenn die Höhe stimmt, montieren Sie durch den alten Rauchrohranschluss.

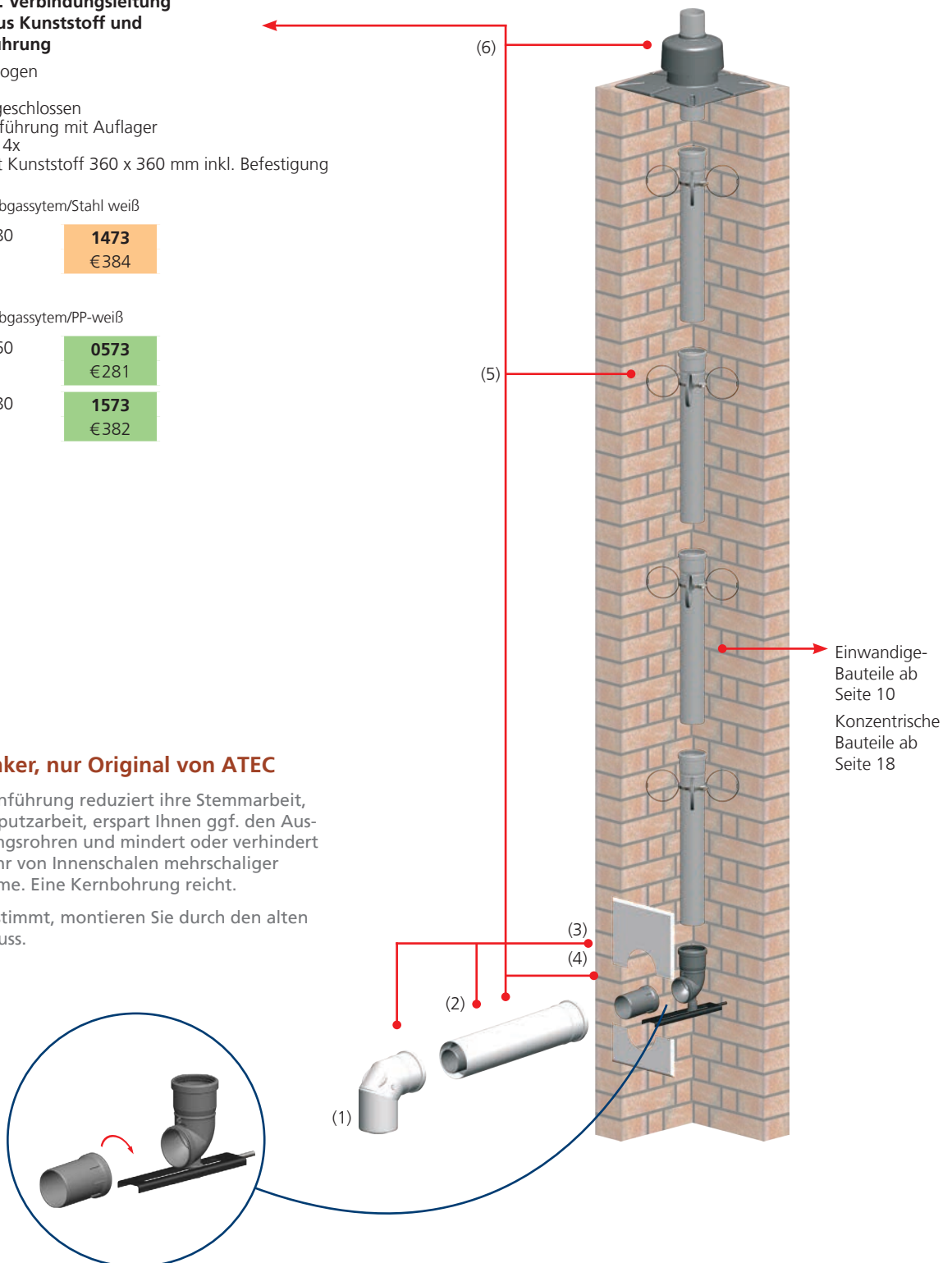

Schacht-Set inkl. Verbindungsleitung mit Mündung aus Kunststoff

- (1) 87°-Kontroll-Bogen
- (2) Rohr 500 mm
- (3) Wandblende geschlossen
- (4) Schachteinführung mit Auflager
- (5) Abstandhalter 4x
- (6) Mündungs-Set Kunststoff 360 x 360 mm inkl. Befestigung

PolyClassic PP-Abgassystem/Stahl weiß

DN 80/125 - DN 80	1470 €330
DN 100/150 - DN 100	2480 €540

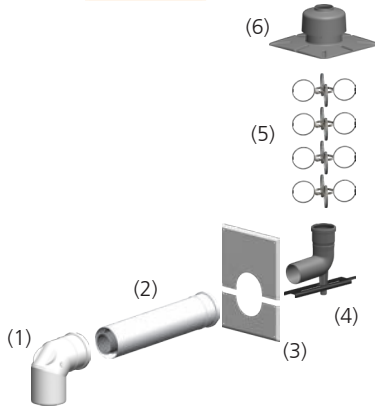

PolyTwin PP-Abgassystem/PP-weiß

DN 60/100 - DN 60	0570 €222
DN 60/100 - DN 80	0580 €281
DN 80/125 - DN 80	1570 €327
DN 110/160 - DN 110	3570 €526

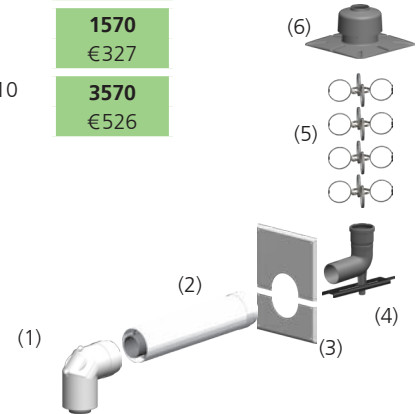

Schacht-Set inkl. Verbindungsleitung mit Mündung aus Edelstahl

- (1) 87°-Kontroll-Bogen
- (2) Rohr 500 mm
- (3) Wandblende geschlossen
- (4) Schachteinführung mit Auflager
- (5) Abstandhalter 4x
- (6) Mündungs-Set Edelstahl 330 x 330 mm inkl. Befestigung

PolyClassic PP-Abgassystem/Stahl weiß

DN 80/125 - DN 80	1471 €474
-------------------	---------------------

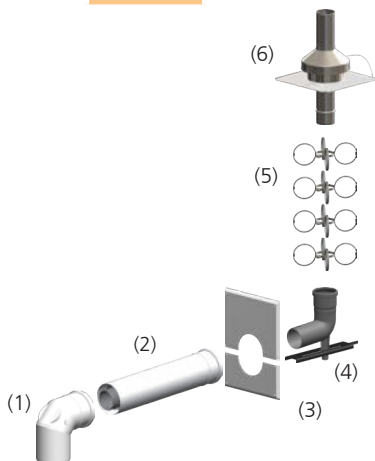

PolyTwin PP-Abgassystem/PP-weiß

DN 60/100 - DN 60	0571 €369
DN 60/100 - DN 80	0581 €413
DN 80/125 - DN 80	1571 €470

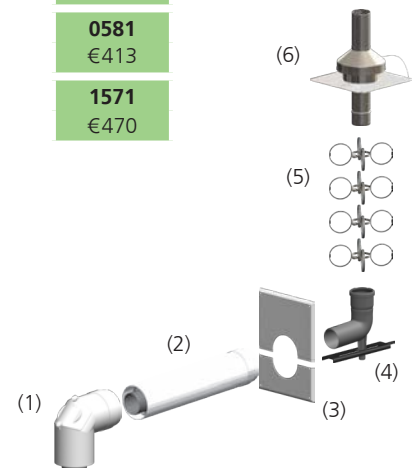

! Bei Montagen mit flexiblem Rohr ist zusätzlich eine Kupplung (siehe Seite 11) notwendig.

KONZENTRISCH

87°-Kontroll-Bogen, konzentrisch

DN 80/125	1401 €131	
DN 100/150	2401 €218	

Kontroll-Rohr, konzentrisch

DN 80/125	1403 €115	
DN 100/150	2403 €197	

30°-Bogen, konzentrisch

DN 80/125	1414 €58	
DN 100/150	2414 €124	

45°-Bogen, konzentrisch

DN 80/125	1415 €59	
DN 100/150	2415 €108	

87°-Bogen, konzentrisch

DN 80/125	1416 €83	
DN 100/150	2416 €108	

Rohr, konzentrisch, kürzbar

DN 80/125	1417 €52		Nutzlänge 255 mm
DN 100/150	2417 €81		
DN 80/125	1418 €61		500 mm
DN 100/150	2418 €98		
DN 80/125	1419 €90		955 mm
DN 100/150	2419 €132		
DN 80/125	1420 €165		1.955 mm

Kondensatablauf, konzentrisch mit Siphon

DN 80/125	1448 €83	
DN 100/150	2448 €127	

 Mit 87°-Siphonanschluss auf Seite 12 als senkrechter Kondensatablauf einsetzbar.

Schiebeelement

DN 80/125	1424 €123		Nutzlänge 280 - 420 mm
DN 100/150	2424 €156		280 - 420 mm

Schachteinführung, konzentrisch

DN 80/125	1434 €132	
DN 100/150	2434 €218	

**87°-Kontroll-Bogen mit seitlichen Messöffnungen für Zu-
luft/Abgas**

DN 80/125	1219 €161	
-----------	---------------------	---

Kesselanschluss mit Messöffnung, gerade

DN 80/125	1220 €67	
DN 100/150	2220 €100	

Zuluftansaug-Set für Kontroll-Bauteile

DN 80/125	1478 €61	
DN 100/150	2478 €78	

T-Stück für Kaskade

DN 80/125	1404 €189	
DN 100/150	2404 €233	

87°-Kontroll-Bogen, konzentrisch

DN 60/100	0501 €93
DN 80/125	1501 €125
DN 110/160	3501 €191



Kontroll-Rohr, konzentrisch

DN 60/100	0503 €78
DN 80/125	1503 €112
DN 110/160	3503 €177



30°-Bogen, konzentrisch

DN 60/100	0514 €45
DN 80/125	1514 €55
DN 110/160	3514 €95



45°-Bogen, konzentrisch

DN 60/100	0515 €45
DN 80/125	1515 €56
DN 110/160	3515 €95



87°-Bogen, konzentrisch

DN 60/100	0516 €61
DN 80/125	1516 €81
DN 110/160	3516 €105



Rohr, konzentrisch, kürzbar

DN 60/100	0517 €33
DN 80/125	1517 €49
DN 110/160	3517 €72
DN 60/100	0518 €44
DN 80/125	1518 €59
DN 110/160	3518 €87
DN 60/100	0519 €57
DN 80/125	1519 €86
DN 110/160	3519 €117
DN 60/100	0520 €112
DN 80/125	1520 €157



Kondensatablauf, konzentrisch mit Siphon

DN 60/100	0548 €73
DN 80/125	1548 €81
DN 110/160	3548 €95



Mit 87°-Siphonanschluss auf Seite 12 als senkrechter Kondensatablauf einsetzbar.

Schachteinführung, konzentrisch

DN 60/100	0534 €103
DN 80/125	1534 €135
DN 110/160	3534 €192



87°-Kontroll-Bogen mit seitlichen Messöffnungen für Zuluft/Abgas

DN 80/125	1819 €155
-----------	---------------------



Kesselanschluss mit Messöffnung, gerade

DN 60/100	0820 €72
DN 80/125	1820 €72
DN 110/160	3820 €82



Zuluftansaug-Set für Kontroll-Bauteile

DN 60/100	0578 €55
DN 80/125	1578 €60
DN 110/160	3578 €69



T-Stück für Kaskade

DN 60/100	0504 €159
DN 80/125	1504 €178
DN 110/160	3504 €180



Zuluftstutzen

DN 80/125 D 80	1584 €95
DN 110/160 D 100	3584 €118

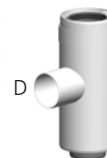

DN 60/100 DN 80/125 DN 100/150 DN 110/160

Mündungs-Set konzentrisch

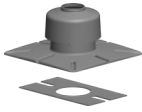

0438 € 133	1438 € 155	2438 € 190	3438 € 181
----------------------	----------------------	----------------------	----------------------

Wandblende geschlossen



280 x 340 mm

0428 € 44	1428 € 44	2428 € 45	3428 € 48
---------------------	---------------------	---------------------	---------------------

Kaminabschluss für Unterdach

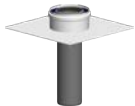

300 x 300 mm

0538 € 104	1538 € 102	2538 € 107	3538 € 122
----------------------	----------------------	----------------------	----------------------

Flexrohraufhängung, in Verbindung mit Kaminabschluss und Kupplung für Rohr flexibel



169012 € 41	169013 € 41	169014 € 42	169015 € 45
-----------------------	-----------------------	-----------------------	-----------------------

Kupplung (siehe Seite 11) bei Rohr flexibel notwendig.

Außenwandanschluss



	0480 € 100	1480 € 115
Baulänge	851 mm	891 mm

Vor der Montage muss die Zustimmung durch den bevollmächtigten Bezirksschornsteinfeger erfolgen.



Durchmesser der Erhöhung: F in mm Ø 140 Ø 160 Ø 200 Ø 250 Ø 300 Ø 350

Festbrennstoffzugerhöhung Ziegelschornstein

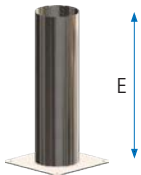

	601401 € 167	601403 € 180	601405 € 223	601406 € 273	601408 € 378	601410 € 421
A x B in mm	250 x 250	250 x 333	250 x 333	333 x 333	500 x 500	500 x 500
C x D in mm	210 x 210	210 x 293	210 x 293	293 x 293	460 x 460	460 x 460
E in mm	500	500	500	500	500	500

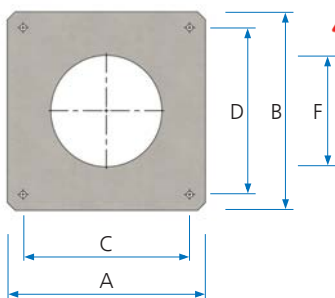

Nur bei trockenem Betrieb verwendbar

Regenhaube für Festbrennstoffzugerhöhung



601430 € 80	601431 € 92	601432 € 96	601433 € 108	601434 € 131	601435 € 171
-----------------------	-----------------------	-----------------------	------------------------	------------------------	------------------------

DN 60/100 DN 80/125 DN 100/150 DN 110/160

Befestigungs-Set weiß



601750 € 36,30	601751 € 38,13	601752 € 38,59	601753 € 40,60
--------------------------	--------------------------	--------------------------	--------------------------

**87°-Kontroll-Bogen mit seitlichen Messöffnungen für Zu-
luft/Abgas**

Durchmesser		PolyClassic PP/Stahl weiß	PolyTwin PP/PP weiß	
Eintauch- seite:	Muffen- seite			
80/130	80/125	1201 €173		
80/110	80/125	1217 €161		
universell*	80/125	1219 €161	1819 €155	
80/126	80/125	1271 €180	1871 €155	
80 kurz 125	80/125	1273 €161	1873 €157	

Kesselanschluss mit Messöffnung, gerade

Durchmesser		PolyClassic PP/Stahl weiß	PolyTwin PP/PP weiß	
Eintauch- seite:	Muffen- seite			
universell*	60/100		0820 €72	
60/110	80/125	1204 €117		
80/110	80/125	1218 €90		
universell*	80/125	1220 €67	1820 €72	
80/126	80/125	1270 €94		
universell*	100/150	2220 €100		
universell*	110/160		3820 €82	

Adapter



Durchmesser		PolyTwin PP/PP weiß	
Eintauch- seite:	Muffen- seite		
Adapter 30 mm	60/100	0801 €24	
Adapter 15 mm	80/125	1884 €20	
Adapter 30 mm	110/160	3884 €25	

87°-Kontroll-Bogen

Durchmesser		PolyClassic PP/Stahl weiß	PolyTwin PP/PP weiß	
Eintauch- seite:	Muffen- seite			
70/110	80/125	1205 €161	1805 €145	
63/96	80/125	1223 €173	1823 €145	
60/100	80/125	1267 €173	1869 €142	

Übergang

Durchmesser		PolyClassic PP/Stahl weiß	PolyTwin PP/PP weiß	
Eintauch- seite:	Muffen- seite			
Schelle Viessmann	60/100		0805 €31	
Schelle/ Verbinder	60/100		0840 €23	
80/125	60/100		0866 €61	
70/110	80/125	1206 €56		
63/96	80/125	1222 €62		
60/100	80/125	1266 €62	1866 €61	
100/150	80/125	1225 €110		
110/160	80/125		1868 €161	
Schelle/ Verbinder	80/125	1240 €25	1840 €24	
80/125	100/150	2266 €97		
110/158	100/150	2227 €62		
110/160	100/150	2221 €123		
60/100	110/160		3264 €127	
80/125	110/160		3266 €84	
100/150	110/160		3268 €84	
110/150	110/160		2267 €86	

-  Weitere Übergänge in Vorbereitung/auf Anfrage.
-  Alle Übergänge für das System PolyClassic passen auch für PolyTwin.

* universell: Eintauchseite gleich Muffenseite

DN 60/100 DN 80/125 DN 100/150 DN 110/160

Dachhochführung, konzentrisch inklusive Befestigungsschelle

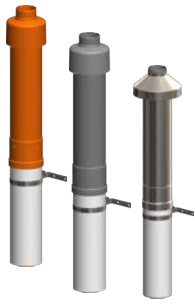

ziegelrot 650 mm	0457 € 169	1457 € 192		
schwarz 650 mm	0458 € 169	1458 € 192		
Edelstahl 650 mm		1455 € 320		
ziegelrot 1.100 mm		1459 € 263	2459 € 362	3459 € 342
schwarz 1.100 mm		1460 € 263	2460 € 362	3460 € 342

Verlängerung zur Dachhochführung (kürz- und verlängerbar)

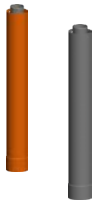

ziegelrot 955 mm	620457 € 119	621457 € 135		623457 € 281
schwarz 955 mm	620458 € 119	621458 € 135		623458 € 281

Schrägdachpfanne 5° - 45° (unabhängig von der Dacheindeckung)

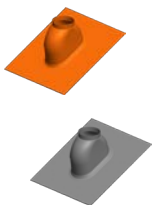

ziegelrot 470 x 560 mm	1555 € 126	1555 € 126		
schwarz 470 x 560 mm	1556 € 126	1556 € 126		
ziegelrot 470 x 700 mm	1557 € 150	1557 € 150	500 x 700 mm	3557 € 160
schwarz 470 x 700 mm	1558 € 150	1558 € 150	500 x 700 mm	3558 € 160

Schrägdachpfanne 25° - 50° (Universal Dachdurchführung 360 x 395 mm)

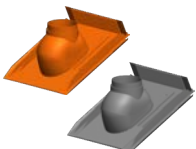

ziegelrot	1467 € 126	1467 € 126
schwarz	1468 € 126	1468 € 126

Schrägdachpfanne 25° - 45°

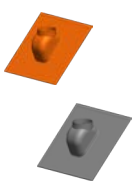

ziegelrot 450 x 450 mm	1561 € 85	1561 € 85		
schwarz 450 x 450 mm	1562 € 85	1562 € 85		
ziegelrot 500 x 500 mm				2461 € 113
schwarz 500 x 500 mm				2462 € 113

Abdeckblende für innen und außen, geteilt, bis 45° Neigung



	0429 € 56	1429 € 56	2429 € 62	3429 € 62
Edelstahl weiß beschichtet				

Mündungs-Abströmdüse (Windschutzschirm)

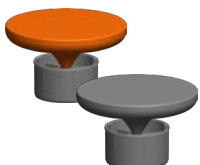

ziegelrot	0461 € 54	1461 € 57
schwarz	0462 € 54	1462 € 57

DN 60/100 DN 80/125 DN 100/150 DN 110/160

Flachdachkragen



	1466 €53	1466 €53	2466 €82	3466 €107
Bauhöhe in mm	150	150	150	150

Adapter für Klöber-Grundplatten

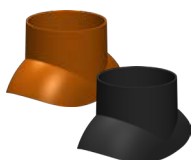

ziegelrot	1247 €69	1247 €69		
schwarz	1248 €69	1248 €69		

Braas Abgaskalotte DuroVent 128



ziegelrot	1257 €69	1257 €69		
schwarz	1258 €69	1258 €69		

Abspannschelle (Spannbänder bauseits)



640459 €81	641459 €81	642459 €109	643459 €117
----------------------	----------------------	-----------------------	-----------------------

Schrägdachpfanne als Sonderanfertigung bis 60°, Lieferzeit ca. 14 Tage

Bei Bestellung muss die Dachneigung angegeben werden.



☞ Bleikragen mit Edelstahlstützen

601662 €334	601662 €334	602662 €334	603662 €334
-----------------------	-----------------------	-----------------------	-----------------------

Flexible Flachdachdurchführung bis 20° (inklusive Schrauben und Kleber)

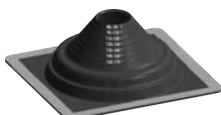

☞ Verwendbar für Blech-, Trapezblech- und Faserzementdächer

	701610 €255	702610 €255
Grundfläche	270 x 290 mm	375 x 415 mm

Flachdach-Abgasdurchgang

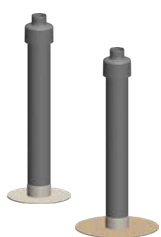

Oberteil PVC	701565 €290	703565 €507
Oberteil Bitumen-Schweißbahn	701566 €299	703566 €518
Gesamtlänge	1040 mm	1250 mm

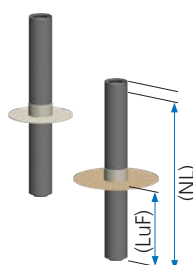

Unterteil PVC	701563 €259	703563 €451
Unterteil Bitumen-Schweißbahn	701564 €267	703564 €461
Nutzlänge (NL)	955	958
Länge unter Flansch (LuF)	455	359

☞ Weitere Flachdachdurchführungen bis 20° siehe auch Seite 50

KONZENTRISCH

AUßENWAND

ATEC | ABGASSYSTEME

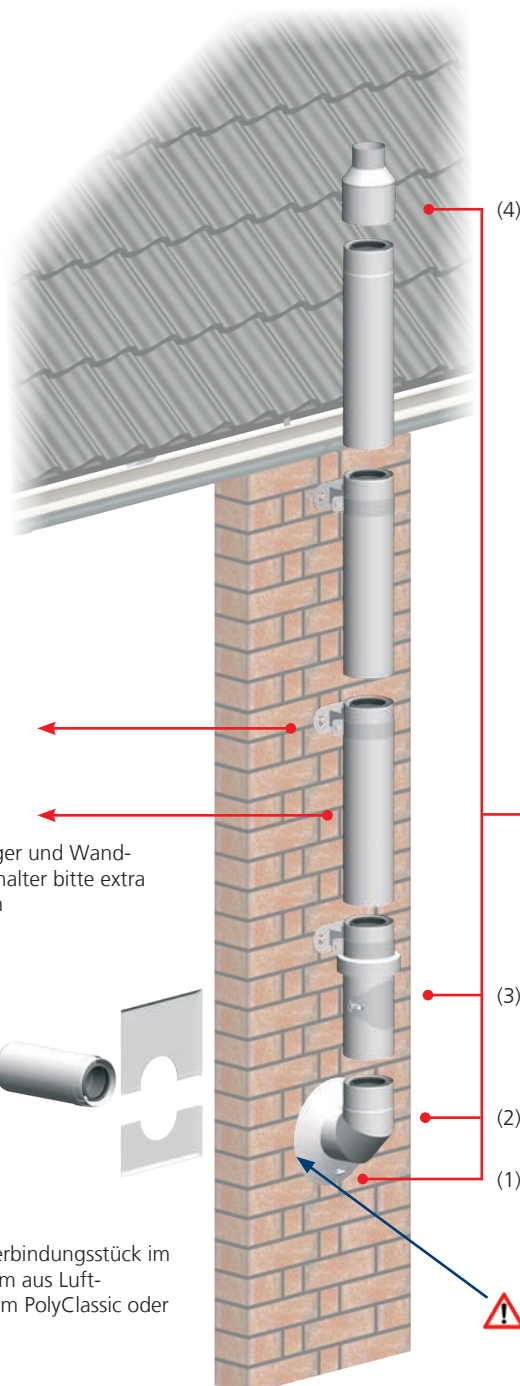

WhitePoly
Bauteile ab
Seite 25

! Querträger und Wand-
abstandhalter bitte extra
bestellen

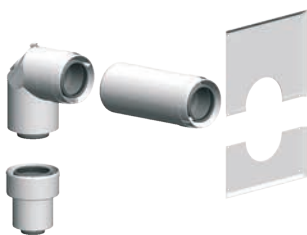

Beispiel: Verbindungsstück im
Aufstellraum aus Luft-
Abgassystem PolyClassic oder
PolyTwin

DN 60/100 DN 80/125

Dachhochführung



ziegelrot, 650 mm

710757
€259

711757
€273

schwarz, 650 mm

710758
€259

711758
€273

! Schrägdachpfanne und Flachdachkragen
siehe Seiten 22, 23 und 31.

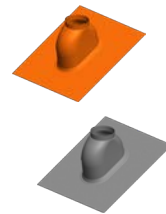

Basis-Set für die Installation an der Außenwand

- (1) Wandrosette
 - (2) 87°-Bogen
 - (3) Kontroll-Rohr mit Zuluftansaugung
 - (4) Mündungsabschluss
- WhitePoly** PP/Edelstahl weiß

		Nutzlänge
DN 60/100	710770 €386	475 mm
DN 80/125	711770 €421	530 mm
DN 100/150	712770 €506	575 mm
DN 110/160	713770 €572	585 mm

! Im Bereich der Wand-
durchführung ist White/
IronPoly zu verwenden.

DN 60/100 DN 80/125 DN 100/150 DN 110/160

Erweiterung, exzentrisch



DN	711798 €98	712798 €137	713798 €163
D	D 60/100	D 80/125	D 80/125

Reduzierung, zentrisch



DN	0866 €61	712799 €137
D	D 80/125	D 100/150

Mündungsabschluss



	710754 €72	711754 €72	712754 €88	713754 €92
Nutzlänge	145 mm	145 mm	145 mm	145 mm

Rohrelement, kürzbar



Nutzlänge 190 mm	710717 €69	711717 €78	712717 €83	713717 €100
Nutzlänge 440 mm	710718 €81	711718 €88	712718 €100	713718 €119
Nutzlänge 940 mm	710719 €93	711719 €100	712719 €134	713719 €166

Kontroll-Rohr



	710703 €118	711703 €134	712703 €169	713703 €193
Nutzlänge	245 mm	275 mm	315 mm	230 mm

Kontroll-Rohr mit Zuluftansaugung



	710755 €162	711755 €198	712755 €232	713755 €264
Nutzlänge	245 mm	275 mm	315 mm	315 mm

Zuluftrohr



	710756 €118	711756 €135	712756 €168	713756 €204
Nutzlänge	255 mm	255 mm	255 mm	190 mm

Zwischenkonsole



	710761 €186	711761 €193	712761 €223	713761 €247
--	-----------------------	-----------------------	-----------------------	-----------------------

Zwischenkonsole mit Zuluftöffnung



	710753 €196	711753 €206	712753 €235	713753 €261
--	-----------------------	-----------------------	-----------------------	-----------------------

30°-Bogen



	710714 €80	711714 €96	712714 €118	713714 €142
--	----------------------	----------------------	-----------------------	-----------------------

45°-Bogen



	710715 €80	711715 €96	712715 €118	713715 €142
--	----------------------	----------------------	-----------------------	-----------------------

87°-Bogen



	710716 €100	711716 €100	712716 €136	713716 €165
--	-----------------------	-----------------------	-----------------------	-----------------------

DN 60/100 DN 80/125 DN 100/150 DN 110/160

Aufsatzplatte 330x330 mm

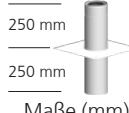

250 mm	710668 €168	711668 €168	712668 €198	713668 €211
250 mm				
Maße (mm)	330 x 330	330 x 330	330 x 330	330 x 330

Klemmband, optional



	710740 €35	711740 €35	712740 €40	713740 €48
--	----------------------	----------------------	----------------------	----------------------

⚠ Abspannschellen siehe Seite 23

Wandrosette



	710728 €53	711728 €53	712728 €53	713728 €54
Außen - Ø	240 mm	265 mm	290 mm	320 mm

Stützbogen 87°



	710734 €259	711734 €296	712734 €308	713734 €356
Nutzlänge (NL)	78 mm	86 mm	100 mm	110 mm

mit Zuluftöffnung

Verankerungsplatte



	710733 €94	711733 €94	712733 €97	713733 €120
--	----------------------	----------------------	----------------------	-----------------------

Wandabstandhalter



50 mm	710742 €92	711742 €92	712742 €110	713742 €112
50-150 mm (kürzbar)	710744 €111	711744 €111	712744 €127	713744 €135
50-360 mm (kürzbar)	710745 €187	711745 €187	712745 €201	713745 €207
50-500 mm (kürzbar)	710746 €216	711746 €216	712746 €233	713746 €239

⚠ Schrauben und Dübel bauseits nach Wandbeschaffenheit.

Dachdurchführung 6° - 32° inkl. Wetterkragen



	700663 €323	701663 €323	702663 €373	703663 €417
--	-----------------------	-----------------------	-----------------------	-----------------------

Dachdurchführung 33° - 45° inkl. Wetterkragen



	700664 €323	701664 €323	702664 €373	703664 €417
--	-----------------------	-----------------------	-----------------------	-----------------------

Kompensatorelement 940 mm (nicht kürzbar)



	711721 €142	712721 €200	713721 €237
--	-----------------------	-----------------------	-----------------------

⚠ In Leitungslängen mit Bögen $\geq 3,0$ m erforderlich

⚠ Einbau als oberstes Element

AUßENWAND

ATEC | ABGASSYSTEME

DN 60/100 DN 80/125

Dachhochführung

		ziegelrot, 650 mm	
		700757 €258	701757 €272
		schwarz, 650 mm	
		700758 €258	701758 €272

 Schrägdachpfanne und Flachdachkragen
siehe Seiten 22, 23 und 31.

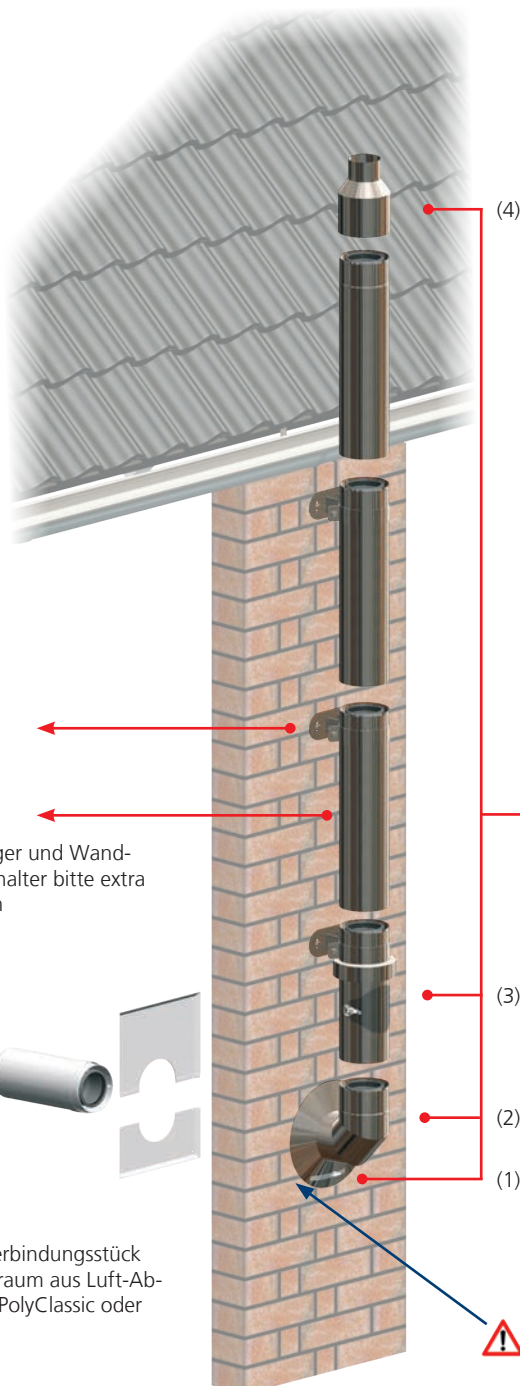
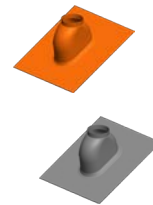

IronPoly
Bauteile ab
Seite 27

 Querträger und Wand-
abstandhalter bitte extra
bestellen

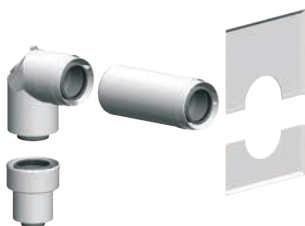

Beispiel: Verbindungsstück
im Aufstellraum aus Luft-Ab-
gassystem PolyClassic oder
PolyTwin

Basis-Set für die Installation an der Außenwand

- (1) Wandrosette (3) Kontroll-Rohr mit Zuluftansaugung
(2) 87°-Bogen (4) Mündungsabschluss

IronPoly	PP/Edelstahl blank	Nutzlänge
DN 60/100	700770 €384	475 mm
DN 80/125	701770 €419	530 mm
DN 100/150	702770 €504	575 mm
DN 110/160	703770 €570	585 mm

 Im Bereich der Wanddurch-
führung ist WhitePoly oder
IronPoly zu verwenden.

DN 60/100 DN 80/125 DN 100/150 DN 110/160

Mündungsabschluss	DN 60/100	DN 80/125	DN 100/150	DN 110/160
	700754 €72	701754 €72	702754 €88	703754 €91
Nutzlänge	145 mm	145 mm	145 mm	145 mm

Rohrelement, kürzbar	DN 60/100	DN 80/125	DN 100/150	DN 110/160
	Nutzlänge 190 mm			
	700717 €69	701717 €78	702717 €82	703717 €99
	Nutzlänge 440 mm			
	700718 €81	701718 €88	702718 €99	703718 €119
	Nutzlänge 940 mm			
	700719 €92	701719 €99	702719 €133	703719 €165

Kontroll-Rohr	DN 60/100	DN 80/125	DN 100/150	DN 110/160
	700703 €117	701703 €133	702703 €168	703703 €192
Nutzlänge	245 mm	275 mm	315 mm	230 mm

Kontroll-Rohr mit Zuluftansaugung	DN 60/100	DN 80/125	DN 100/150	DN 110/160
	700755 €162	701755 €197	702755 €231	703755 €263
Nutzlänge	245 mm	275 mm	315 mm	315 mm

Zuluftrohr	DN 60/100	DN 80/125	DN 100/150	DN 110/160
	700756 €117	701756 €134	702756 €167	703756 €204
Nutzlänge	255 mm	255 mm	255 mm	190 mm

Zwischenkonsole	DN 60/100	DN 80/125	DN 100/150	DN 110/160
	700761 €185	701761 €192	702761 €222	703761 €246

Zwischenkonsole mit Zuluftöffnung	DN 60/100	DN 80/125	DN 100/150	DN 110/160
	700753 €196	701753 €205	702753 €234	703753 €260

30°-Bogen	DN 60/100	DN 80/125	DN 100/150	DN 110/160
	700714 €80	701714 €96	702714 €117	703714 €141

45°-Bogen	DN 60/100	DN 80/125	DN 100/150	DN 110/160
	700715 €80	701715 €96	702715 €117	703715 €141

87°-Bogen	DN 60/100	DN 80/125	DN 100/150	DN 110/160
	700716 €99	701716 €99	702716 €136	703716 €164

 Abspannschellen siehe Seite 23

DN 60/100 DN 80/125 DN 100/150 DN 110/160

Klemmband, optional	DN 60/100	DN 80/125	DN 100/150	DN 110/160
	700740 €35	701740 €35	702740 €40	703740 €48

Aufsatzplatte	DN 60/100	DN 80/125	DN 100/150	DN 110/160
	700668 €167	701668 €167	702668 €197	703668 €210
Maße (mm)	330 x 330	330 x 330	330 x 330	330 x 330

Wandrosse	DN 60/100	DN 80/125	DN 100/150	DN 110/160
	700728 €53	701728 €53	702728 €53	703728 €54
Außen - Ø	240 mm	265 mm	290 mm	320 mm



Stützbogen 87°	DN 60/100	DN 80/125	DN 100/150	DN 110/160
	700734 €258	701734 €294	702734 €307	703734 €355
mit Zuluftöffnung				
Nutzlänge (NL)	78 mm	86 mm	100 mm	110 mm

Verankerungsplatte	DN 60/100	DN 80/125	DN 100/150	DN 110/160
	700733 €94	701733 €94	702733 €97	703733 €120



Wandabstandhalter	DN 60/100	DN 80/125	DN 100/150	DN 110/160
	50 mm			
	700742 €91	701742 €91	702742 €109	703742 €112
	50-150 mm (kürzbar)			
	700744 €111	701744 €111	702744 €126	703744 €134
	50-360 mm (kürzbar)			
	700745 €187	701745 €187	702745 €200	703745 €206
	50-500 mm (kürzbar)			
	700746 €215	701746 €215	702746 €232	703746 €238

 Diese Wandabstandhalter sind nicht mit Verlängerungen kombinierbar.
Schrauben und Dübel bauseits nach Wandbeschaffenheit.

Wandabstandhalter 50 mm (mit Verlängerungen siehe Seite 30)	DN 60/100	DN 80/125	DN 100/150	DN 110/160
	700741 €69	701741 €69	702741 €69	703741 €74

Kragarm	DN 60/100	DN 80/125	DN 100/150	DN 110/160
	700799 €2118	701799 €2118	702799 €2118	703799 €2118
Weitere Hinweise und Bestellung siehe Planungs- und Montagehinweise für tragende Systembauteile Art.-Nr. 10001761				

Kompensatorelement 940 mm (nicht kürzbar)	DN 60/100	DN 80/125	DN 100/150	DN 110/160
	701721 €141	702721 €199	703721 €237	

 in Leitungslängen mit Bögen $\geq 3,0$ m erforderlich
 Einbau als oberstes Element

AUßENWAND

ATEC | ABGASSYSTEME

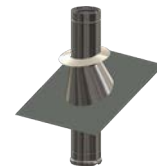
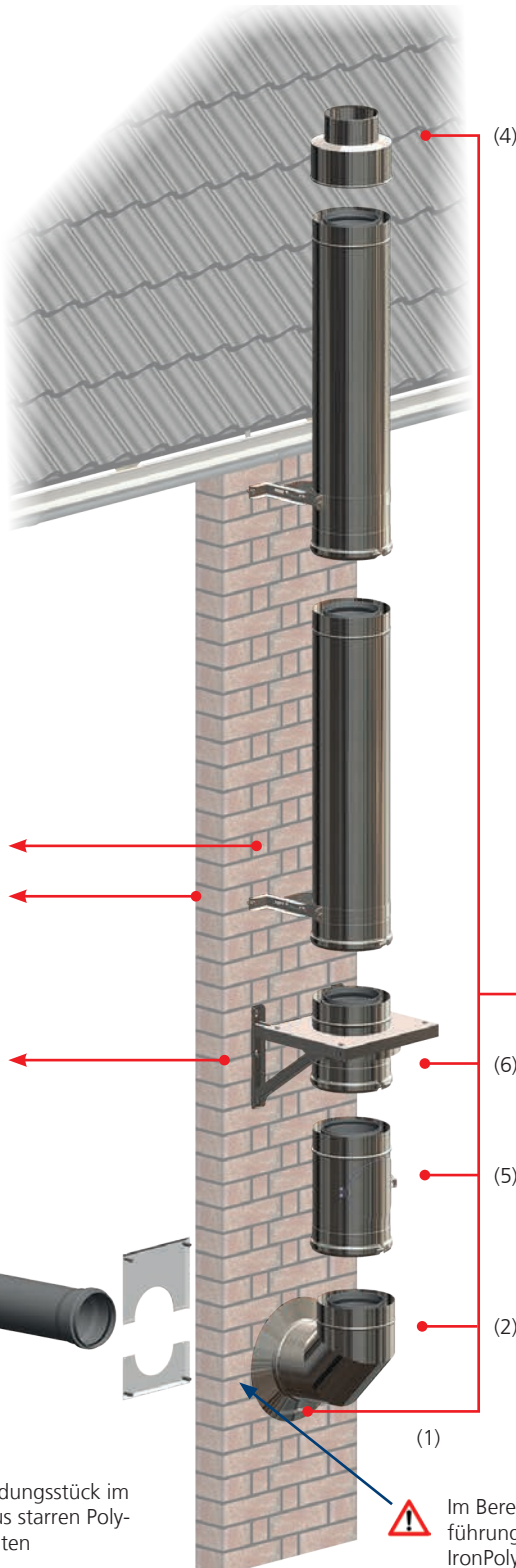

! Dachdurchführungen und Flachdachkragen siehe Seite 31

IronPoly
Bauteile ab Seite 29

Querträger separat bestellen Seite 30



Beispiel: Verbindungsstück im Aufstellraum aus starren Poly-Top-Bauelementen

Basis-Set für die Installation an der Außenwand

- (1) Wandrosette
- (2) 87°-Bogen
- (5) Kontroll-Rohr
- (6) Zwischenkonsole mit Zu-
luftöffnung
- (4) Mündungsabschluss

	PP/Edelstahl blank	Nutzlänge
IronPoly DN 125/190	704770 €1054	845 mm
DN 160/230	706770 €1269	865 mm
DN 200/265	708770 €1494	1.000 mm
DN 250/315	709770 €1810	1.100 mm

! Im Bereich der Wanddurchführung ist WhitePoly oder IronPoly zu verwenden.

DN 125/190 DN 160/230 DN 200/265 DN 250/315

Erweiterung exzentrisch

	704797 €290	706797 €348		
	D 100/150	D 100/150		
	704798 €290	706798 €348	708798 €383	709798 €452
	D 110/160	D 110/160	D 110/160	D 200/260

Mündungsabschluss

	704754 €126	706754 €136	708754 €143	709754 €153
Nutzlänge	200 mm	200 mm	200 mm	200 mm

Rohrelement, kürzbar

	Nutzlänge 190 mm			
	704717 €126	706717 €143	708717 €162	709717 €210
	Nutzlänge 440 mm			
	704718 €143	706718 €167	708718 €205	709718 €231
	Nutzlänge 940 mm			
	704719 €196	706719 €231	708719 €289	709719 €401

Kontroll-Rohr

	704703 €332	706703 €425	708703 €503	709703 €596
Nutzlänge	270 mm	280 mm	400 mm	480 mm

Zuluftrohr

	704784 €231	706784 €299	708784 €366	709784 €443
Nutzlänge	255 mm	255 mm	255 mm	255 mm

Zwischenkonsole

	704761 €258	706761 €330	708761 €419	709761 €524
---	-----------------------	-----------------------	-----------------------	-----------------------

Zwischenkonsole mit Zuluftöffnung

	704753 €272	706753 €349	708753 €443	709753 €554
Nutzlänge	255 mm	255 mm	255 mm	255 mm

30°-Bogen

	704714 €167	706714 €200	708714 €264	709714 €349
---	-----------------------	-----------------------	-----------------------	-----------------------

45°-Bogen

	704715 €167	706715 €207	708715 €265	709715 €349
---	-----------------------	-----------------------	-----------------------	-----------------------

87°-Bogen

	704716 €268	706716 €299	708716 €339	709716 €425
---	-----------------------	-----------------------	-----------------------	-----------------------

 87°-Kontroll-Bogen siehe Seite 37

DN 125/190 DN 160/230 DN 200/265 DN 250/315

Aufsatzplatte

	704752 €126	706752 €136	708752 €143	709752 €153
Maße (mm)	400 x 400	500 x 500	550 x 550	600 x 600

Abspannschelle

	644459 €108	646459 €117	648459 €128	649459 €146
---	-----------------------	-----------------------	-----------------------	-----------------------

 Spannseile sind bauseits zu bestellen.

Zuluftelement für raumluftunabhängige Betriebsweise

	704755 €162	706755 €205	708755 €255	709755 €332
D	D 125	D 160	D 200	D 250
Nutzlänge	440 mm	440 mm	440 mm	440 mm

Wandrosette

	704728 €57	706728 €63	708728 €69	709728 €75
Außen-Ø	320 mm	360 mm	395 mm	445 mm

Stützbogen 87°

	704734 €472	706734 €518	708734 €592	709734 €786
Nutzlänge (NL)	150 mm	170 mm	220 mm	245 mm

mit Zuluftöffnung

 In Kombination mit der Verankerungsplatte zum Aufbau auf einem Fundamentsockel.

Verankerungsplatte

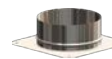
	704733 €125	706733 €128	708733 €132	709733 €146
Maße (mm)	260 x 260	320 x 320	350 x 350	400 x 400

Wandabstandhalter (mit Verlängerungen siehe Seite 30)

	704742 €75	706742 €81	708742 €83	709742 €87
---	----------------------	----------------------	----------------------	----------------------

Kragarm

	704799 €2118	706799 €2118
---	------------------------	------------------------

Weitere Hinweise und Bestellung siehe Planungs- und Montagehinweise für tragende Systembauteile Art.-Nr. 10001761



Kompensatorelement 940 mm (nicht kürzbar)

	704721 €276	706721 €332
---	-----------------------	-----------------------

 in Leitungslängen mit Bögen $\geq 3,0$ m erforderlich

 Einbau als oberstes Element

DN 60/100 DN 80/125 DN 100/150 DN 110/160 DN 125/190 DN 160/230 DN 200/265 DN 250/315

Konsolbleche, verstellbar 50 - 150 mm (Paar: links und rechts)



704771 €170	706771 €205	708771 €289	709771 €383
-----------------------	-----------------------	-----------------------	-----------------------

Querträger, kürzbar (Set: 2 Stück)

500 mm	Edelstahl weiß	714746 €245							
	Edelstahl blank	704746 €245							
li. Wandabstand WA									
Verankerungsplatte	min.	103 mm ¹⁾	90 mm ¹⁾	78 mm ¹⁾	73 mm ¹⁾	50 mm	50 mm	50 mm	50 mm
	max.	332 mm	320 mm	307 mm	303 mm	275 mm	275 mm	195 mm	142 mm
Zwischenkonsole	min.	120 mm ¹⁾	95 mm ¹⁾	70 mm ¹⁾	60 mm ¹⁾	50 mm	50 mm	50 mm	50 mm
	max.	350 mm	325 mm	300 mm	290 mm	262 mm	217 mm	195 mm	145 mm

750 mm	Edelstahl weiß	714747 €300							
	Edelstahl blank	704747 €299							
li. Wandabstand WA									
Verankerungsplatte	min.	303 mm	290 mm	278 mm	273 mm	245 mm	195 mm	163 mm	103 mm
	max.	582 mm	570 mm	557 mm	553 mm	525 mm	475 mm	442 mm	392 mm
Zwischenkonsole	min.	320 mm	295 mm	270 mm	260 mm	232 mm	188 mm	165 mm	115 mm
	max.	600 mm	575 mm	550 mm	540 mm	512 mm	467 mm	455 mm	395 mm

1030 mm	Edelstahl weiß	714749 €490							
	Edelstahl blank	704749 €489							
li. Wandabstand WA									
Verankerungsplatte	min.	583 mm	570 mm	558 mm	533 mm	525 mm	475 mm	443 mm	393 mm
	max.	862 mm	850 mm	837 mm	833 mm	805 mm	755 mm	722 mm	672 mm
Zwischenkonsole	min.	600 mm	575 mm	550 mm	540 mm	513 mm	468 mm	445 mm	375 mm
	max.	880 mm	855 mm	830 mm	820 mm	792 mm	747 mm	725 mm	675 mm

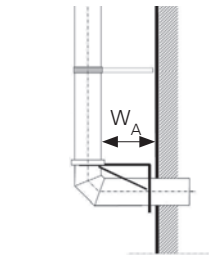

¹⁾ Bei Reduzierung der min. Wandabstände auf 50 mm müssen die Querstreben entfallen und ggf. die Belastung der Abstützung überprüft werden!



Hinweis: Für Wandabstände größer 360 mm ist, unter Berücksichtigung der Wandbaustoffe, ein bauseitiger statischer Nachweis über die zulässigen Lastableitungen in die Wand zu führen. Hierbei sind die Auszugswerte der Schwerlastanker zu beachten.

Verlängerungen für 700741 bis 709742 (siehe Seite 27 und 29), (Set: 2 Stück)

Verlängerung für Wandabstandhalter 60 - 140 mm



704743
€75

Verlängerung für Wandabstandhalter 80 - 240 mm



704744
€84

Verlängerung für Wandabstandhalter 50 - 350 mm



704745
€92

Verlängerung für Wandabstandhalter 50 - 450 mm



704750
€143

Verlängerung für Wandabstandhalter 50 - 700 mm



704751
€199

Verlängerung für Wandabstandhalter 50 - 1100 mm



704756
€220

DN 60/100 DN 80/125 DN 100/150 DN 110/160 DN 125/190 DN 160/230 DN 200/265 DN 250/315

Flachdachkragen 0° - 5° inkl. Wetterkragen



Außenmaß
in mm

Aufsatzplatte von Seite 27 verwenden

704666 €243	706666 €280	708666 €369	709666 €416
606x606	646x646	681x681	731x731

Flexible Flachdachdurchführung

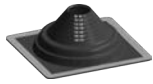

701610 €255	702610 €255
-----------------------	-----------------------

Dachdurchführung 6° - 32° inkl. Wetterkragen



Außenmaß
in mm

700663 €323	701663 €323	702663 €373	703663 €417	704768 €425	706768 €461	708663 €561	709663 €609
651x618	676x645	701x671	711x681	741x714	781x756	816x793	866x846

Dachdurchführung 33° - 45° inkl. Wetterkragen

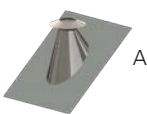

Außenmaß
in mm

700664 €323	701664 €323	702664 €373	703664 €417	704769 €425	706769 €461	708664 €561	709664 €609
651x787	676x819	701x851	711x863	741x903	781x954	816x999	866x1063

Vario-Dachflansch (Edelstahl) mit Dampfbremse

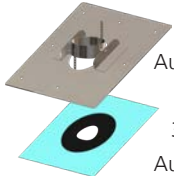

0° - 30°
Außenmaß
in mm

440464 €298	440465 €298	440235 €298	440233 €326	440239 €343	440246 €344	440152 €537	440466 €595
480x480	480x480	480x480	480x480	480x480	480x480	480x480	480x480

30° - 60°
Außenmaß
in mm

440500 €298	440501 €298	440502 €298	440245 €314	440503 €343	440504 €364	440505 €537	440506 €595
480x480	480x480	480x480	480x480	480x630	480x710	540x780	540x880

Anwendungsbeispiele Vario-Dachflansch

Entsprechend der EnEV (Energieeinsparverordnung) sind Dächer nicht nur zu dämmen, sondern auch gegen unkontrollierte Luftströmungen abzudichten und Lüftungswärmeverluste zu vermeiden. Dach-Durchdringungen von Abgasanlagen gegenüber Warmräumen kommt hierbei eine besondere Bedeutung zu. Raumseitig ist mit Luft- und Dampfbremsen eine Luftdichtheitsschicht zu gewährleisten.

Der Vario-Dachflansch, in Verbindung mit Klebemanschetten, vereinfacht die Herstellung einer fachgerechten und winddichten Dachdurchdringung.

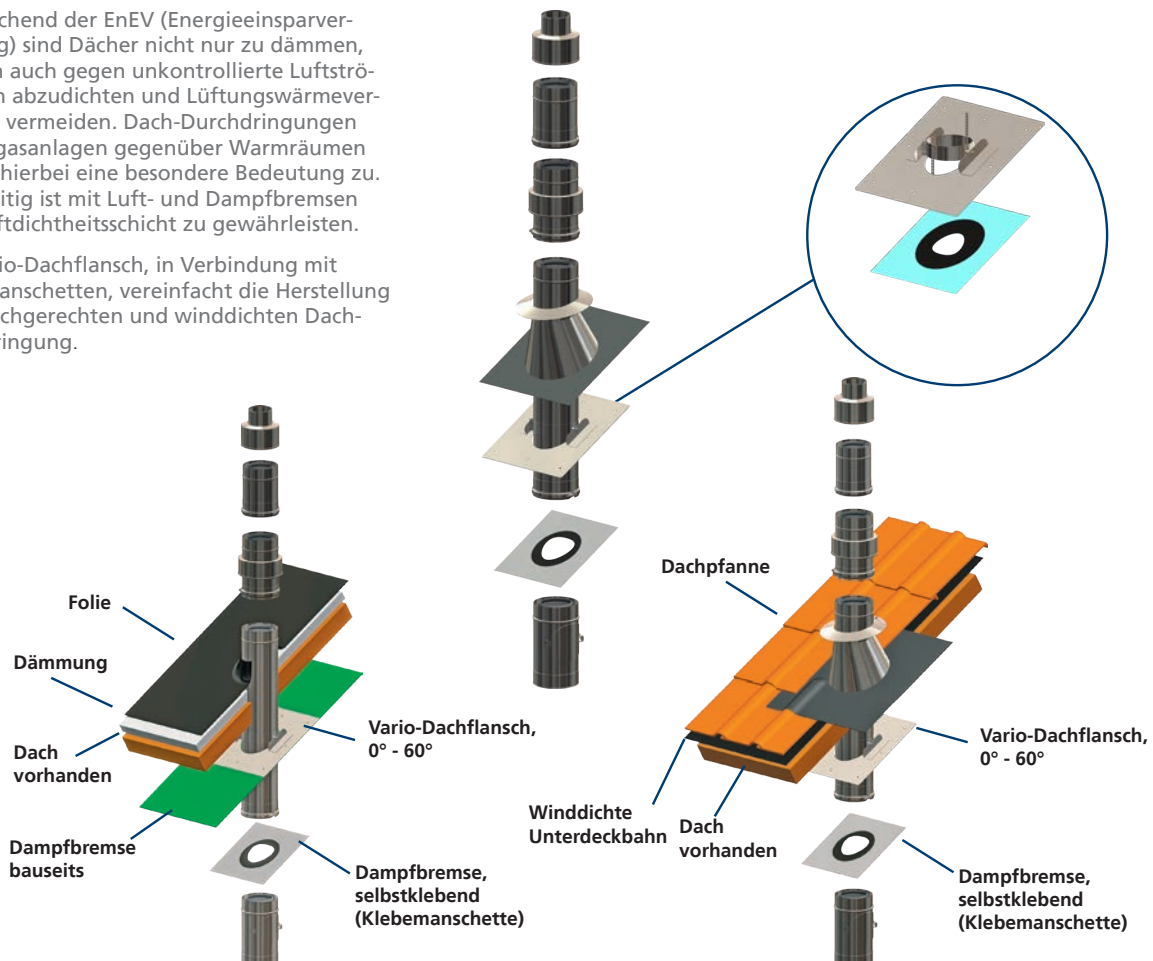

AUßENWAND



ATEC – eine handwerker- und betreiberfreundliche Langzeitlösung für typische Außenwand-Installationen, für Neu- und Altbauten und Speziallösungen.

Edelstahl V4A

Beständige Außenschale gegen belastete Umgebungsluft wie z.B. salzhaltige See oder Industrieemissionen

+50 % Aufschlag,
mindestens € 200

Artikelnummern: 74xxxx



**Außenrohr verkupfert
Edelstahl gebürstet**

+50 % Aufschlag,
mindestens € 200

Artikelnummern
verkupfert: 72xxxx
Edelstahl gebürstet: 73xxxx

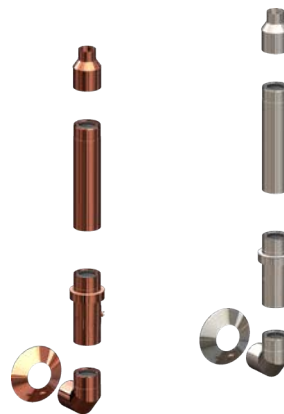

Kupfer-Design

gebürstet

RAL-Farbe nach Wahl

+50 % Aufschlag,
mindestens € 200

Artikelnummern: 75xxxx

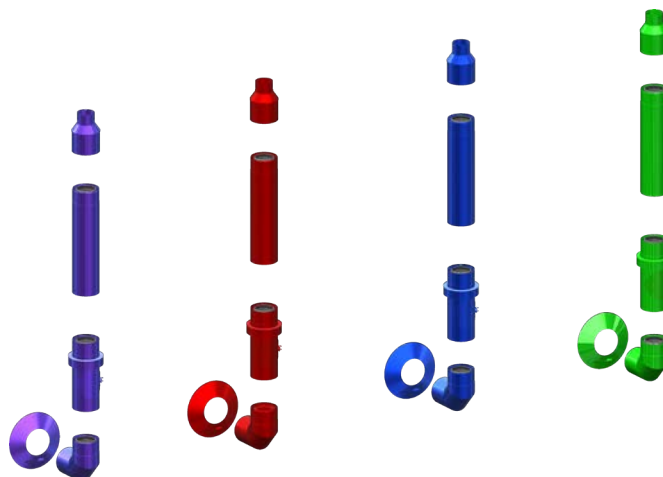

 Lieferzeit bei allen Sonderoberflächen bei allen DN Größen ca. 4 - 6 Wochen. Rückgabe bei Sonderoberflächen ausgeschlossen.

Beispiel: Das Basis-Set DN 60/100 (Art.Nr. 700770) hat in verkupfelter Ausführung die Art-Nr. 720770

AUßENWAND

KASKADEN

ATEC | ABGASSYSTEME

Kaskade raumluftabhängig (mehrfach belegtes, gemeinsames Verbindungsstück für Unter- oder Überdruckbetrieb)

Basis-Set Kaskade:

- (1) Endstück mit Kondensatablauf
- (2) 2 m Kondensatschlauch
- (3) Siphon
- (4) Rohr 255 mm
- (5) Kontroll-Rohr
- (6) Wandblende mit Hinterlüftung

PolyTop

DN 80	601375 €196
DN 100	602375 €218
DN 110	603375 €240
DN 125	604375 €303
DN 160	606375 €372
DN 200	608375 €468
DN 250	609375 €725

Schacht-Set und Abgasrohre
in starr und flexibel
siehe Seite 9-15

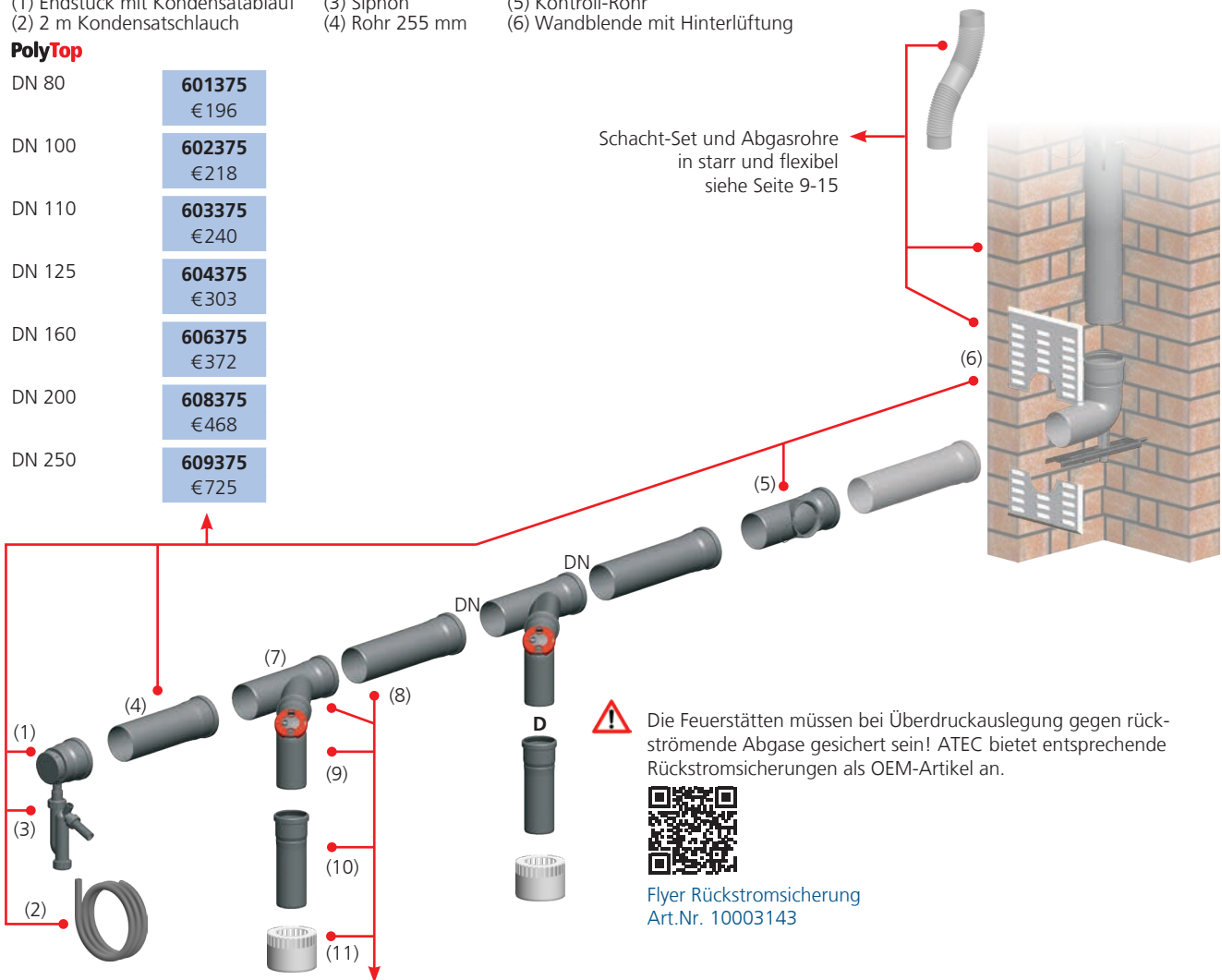

⚠ Die Feuerstätten müssen bei Überdruckauslegung gegen rückströmende Abgase gesichert sein! ATEC bietet entsprechende Rückstromsicherungen als OEM-Artikel an.



Flyer Rückstromsicherung
Art.Nr. 10003143

Erweiterungs-Set bestehend aus:

- (7) Abzweig 42°
- (8) Rohr 955 mm
- (9) 87°-Kontroll-Bogen
- (10) Rohr 255 mm
- (11) Luftgitter bis DN 110

PolyTop	D 80	D 100	D 110	D 125	D 160	D 200
DN 80	601381 €165	DN 125 604382 €251	DN 125 604383 €346	DN 160 606384 €457	DN 200 608383 €427	DN 250 609384 €783
DN 100	602381 €187	DN 160 606382 €330	DN 160 606383 €432	DN 200 608384 €469	DN 250 609383 €719	
DN 110	603381 €232	DN 200 608382 €396	DN 200 608385 €500	DN 250 609386 €574		
DN 125	604381 €232	DN 250 609382 €459	DN 250 609385 €620			

Kaskade raumluftunabhängig (mehrfach belegtes, gemeinsames Verbindungsstück)

DN 80/125 DN 110/160

87°-Kontroll-Bogen, konzentrisch



1501 €125	3501 €191
---------------------	---------------------

Kontroll-Rohr, konzentrisch



1503 €112	3503 €177
---------------------	---------------------

87°-Bogen, konzentrisch



1516 €81	3516 €105
--------------------	---------------------

Rohr, konzentrisch, kürzbar



Nutzlänge	DN 80/125	DN 110/160
255 mm	1517 €49	3517 €72
500 mm	1518 €59	3518 €87
955 mm	1519 €86	3519 €117

DN 80/125 DN 110/160

T-Stück für Kaskade



1504 €178	3504 €180
D80/125	D110/160

T-Stück für Kaskade



3505 €180
D80/125

Kaskade mit Luft-Abgas-System

Abbildung zeigt das Luft-Abgassystem PolyTwin, auch als System PolyClassic in DN 80/125 oder 100/150 lieferbar

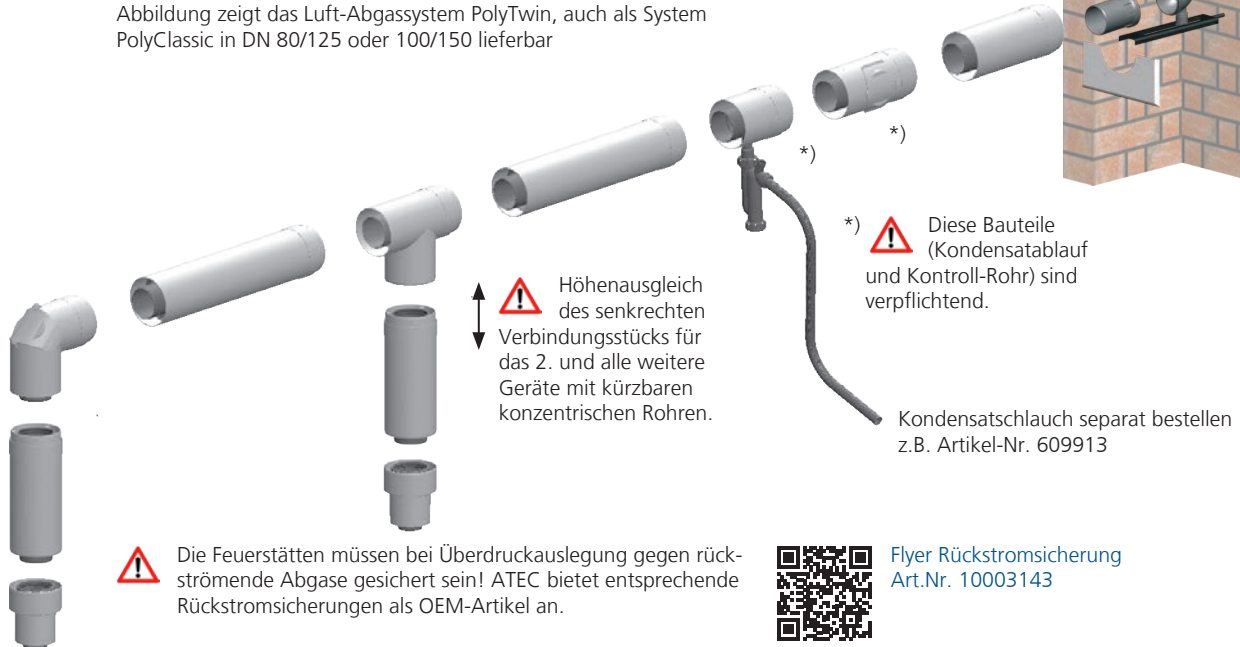

Schacht-Set und Abgasrohre in starr und flexibel siehe Seite 9-15

KASKADEN

DN 80/125 DN 110/160

Erweiterung



D60/100	1866 €61	3264 €127
D80/125		3266 €84

DN 80/125 DN 110/160

Kondensatablauf, konzentrisch mit Siphon



1548 €81	3548 €95
--------------------	--------------------

Wandblende geschlossen



1428 €44	3428 €48
--------------------	--------------------

KASKADEN

ATEC | ABGASSYSTEME

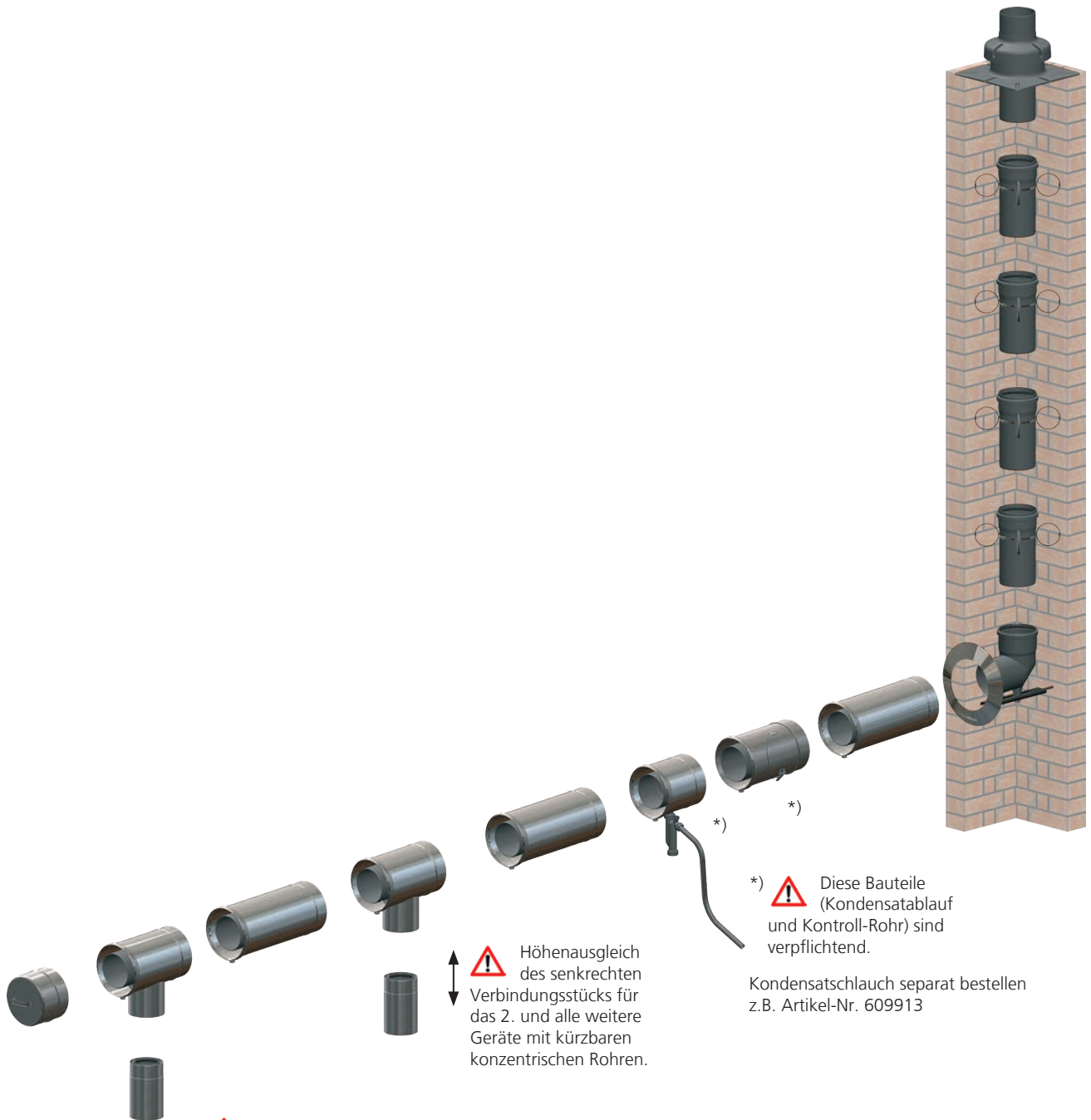

⚠ Die Feuerstätten müssen bei Überdruckauslegung gegen rückströmende Abgase gesichert sein! ATEC bietet entsprechende Rückstromsicherungen als OEM-Artikel an.



Flyer Rückstromsicherung
Art.Nr. 10003143

Kaskade raumluftunabhängig (mehrfach belegtes, gemeinsames Verbindungsstück)

DN 125/190 DN 160/230 DN 200/265

87°-Kontroll-Bogen, konzentrisch



704701 €348	706701 €378	708701 €437
-----------------------	-----------------------	-----------------------

Kontroll-Rohr, konzentrisch



704703 €332	706703 €425	708703 €503
-----------------------	-----------------------	-----------------------

87°-Bogen, konzentrisch



704716 €268	706716 €299	708716 €339
-----------------------	-----------------------	-----------------------

Rohr, konzentrisch, kürzbar

Nutzlänge 190 mm



704717 €126	706717 €143	708717 €162
704718 €143	706718 €167	708718 €205
704719 €196	706719 €231	708719 €289

DN 125/190 DN 160/230 DN 200/265

Kondensatablauf, konzentrisch mit Siphon



704748 €263	706748 €281	708748 €346
-----------------------	-----------------------	-----------------------

T-Stück für Kaskade



704706 €306	706706 €331	
D80/125	D80/125	
704705 €350	706705 €383	708705 €466
D110/160	D110/160	D110/160

Enddeckel für Kaskade



704709 €226	706709 €237	708709 €275
-----------------------	-----------------------	-----------------------

Erweiterungen siehe Seite 21

MEHRFACHBELEGUNG

ATEC | ABGASSYSTEME

Mehrfachbelegung im vorhandenen Schacht DN 100, 125 und 160

Bis zu 10 Gasgeräte bis maximal 30 kW je Gerät an eine gemeinsame Abgasleitung anschließbar (Allgemeine Bauartgenehmigung Z-7.5-3356)

Allgemeine Bauartgenehmigung Nr. Z-7.5-3356 für den Anschluss einzelner oder mehrerer fabrikkatsunabhängiger Gasgeräte mit C4 (Unterdruck), C6 und C(10) (Überdruck) Kennzeichnung.

Wichtig für Wohnungsgesellschaften: Die Gasgeräte müssen kein einheitliches Fabrikat sein, was den Tausch der Geräte vereinfacht.



Montage von vorne:
Frontage-Set

! Die Verbindungsleitung muss aus PolyClassic- Bauteilen erstellt werden. Die Verbindungsleitung aus PolyClassic-Luft-Abgassystembauteile sind bauaufsichtlich geprüfter Bestandteil der Allgemeinen Bauartgenehmigung Z-7.5-3356.

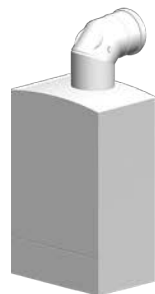

Rohr starr oder flexibel einsetzbar.
Separat bestellen siehe Seiten 10 und 11.

Nur Rohr flexibel einsetzbar.
Separat bestellen siehe Seite 11.

Rohr starr oder flexibel einsetzbar.
Separat bestellen siehe Seiten 10 und 11.

! Die Feuerstätten müssen bei Überdruckauslegung gegen rückströmende Abgase gesichert sein! ATEC bietet entsprechende Rückstromsicherungen als OEM-Artikel an.



Flyer Rückstromsicherung
Art.Nr. 10003143

DN 60/100 DN 80/125

87°-Kontroll-Bogen, konzentrisch



0401 € 130	1401 € 131
----------------------	----------------------

Kontroll-Rohr, konzentrisch



0403 € 104	1403 € 115
----------------------	----------------------

30°-Bogen, konzentrisch



0414 € 58	1414 € 58
---------------------	---------------------

45°-Bogen, konzentrisch



0415 € 59	1415 € 59
---------------------	---------------------

87°-Bogen, konzentrisch



0416 € 82	1416 € 83
---------------------	---------------------

Rohr, konzentrisch, kürzbar



Nutzlänge 255 mm

0417 € 45	1417 € 52
---------------------	---------------------

500 mm

0418 € 55	1418 € 61
---------------------	---------------------

955 mm

0419 € 72	1419 € 90
---------------------	---------------------

DN 100 DN 125

Blinddeckel für Mehrfachbelegung



0409 € 38	1409 € 58
---------------------	---------------------

DN 60 DN 80

Endeckel mit Muffe



490065 € 33	490058 € 36
-----------------------	-----------------------

DN 100 DN 125 DN 160

Basis-Set Mehrfachbelegung

- (1) Siphon und Kondensatschlauch 1,5 m
- (2) Kontroll-Rohr mit Kondensatablauf und Auflager
- (3) Fixschellen
- (4) Flexrohrhülse
- (5) Mündungs-Set



632394 € 235	634394 € 291	636394 € 358
------------------------	------------------------	------------------------

Anschluss-Set Mehrfachbelegung

- (1) Schachtblende
- (2) Wandfutter mit Inbusschraube
- (3) Rohr 255 mm
- (4) Schraubdeckel für T-Stück
- (5) T-Stück mit SV-Anschluss
- (6) Flexrohrhülse 2x
- (7) Fixschellen 2x
- (8) Brandschutzkleber
- (9) Befestigungsset Wandblende

DN 60/100

632380 € 209	634380 € 257	636380 € 358
------------------------	------------------------	------------------------

DN 80/125

632381 € 209	634381 € 257	636381 € 487
------------------------	------------------------	------------------------

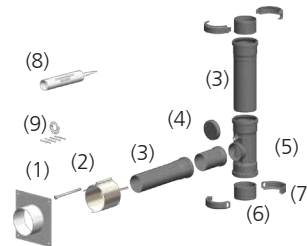

Das Anschluss-Set enthält jetzt standardmäßig das Frontage-Set zur einfachen Montage von vorne.

Kondensatabführung über Schacht

- (1) Kondensatabführung
- (2) Fixschellen
- (3) Flexrohrhülsen
- (4) 0,5 m Schlauch 3/4"

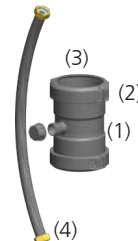

632393 € 178	634393 € 209	636393 € 225
------------------------	------------------------	------------------------

Kondensateinleitung in die Abgasleitung

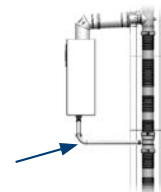

alle DN

Kondensatschlauchverbinder



601336 € 31

MEHRFACHBELEGUNG

ATEC | ABGASSYSTEME

Mehrfachbelegung im vorhandenen Schacht DN 80 und 110

Bis zu 10 Gasgeräte bis maximal 30 kW je Gerät an eine gemeinsame Abgasleitung anschließbar
(Allgemeine Bauartgenehmigung Z-7.5-3356)

Das neue Flexrohr-Bajonett-System

- Lieferbar in 2 m Stangen Flexrohr
- vorinstalliertes Verbindungssystem
- leicht auf das Dach transportierbar
- einfach im Schacht installierbar durch konische Verbindungsstücke - schlanker als bisheriges System
- kürzbar/teilbar

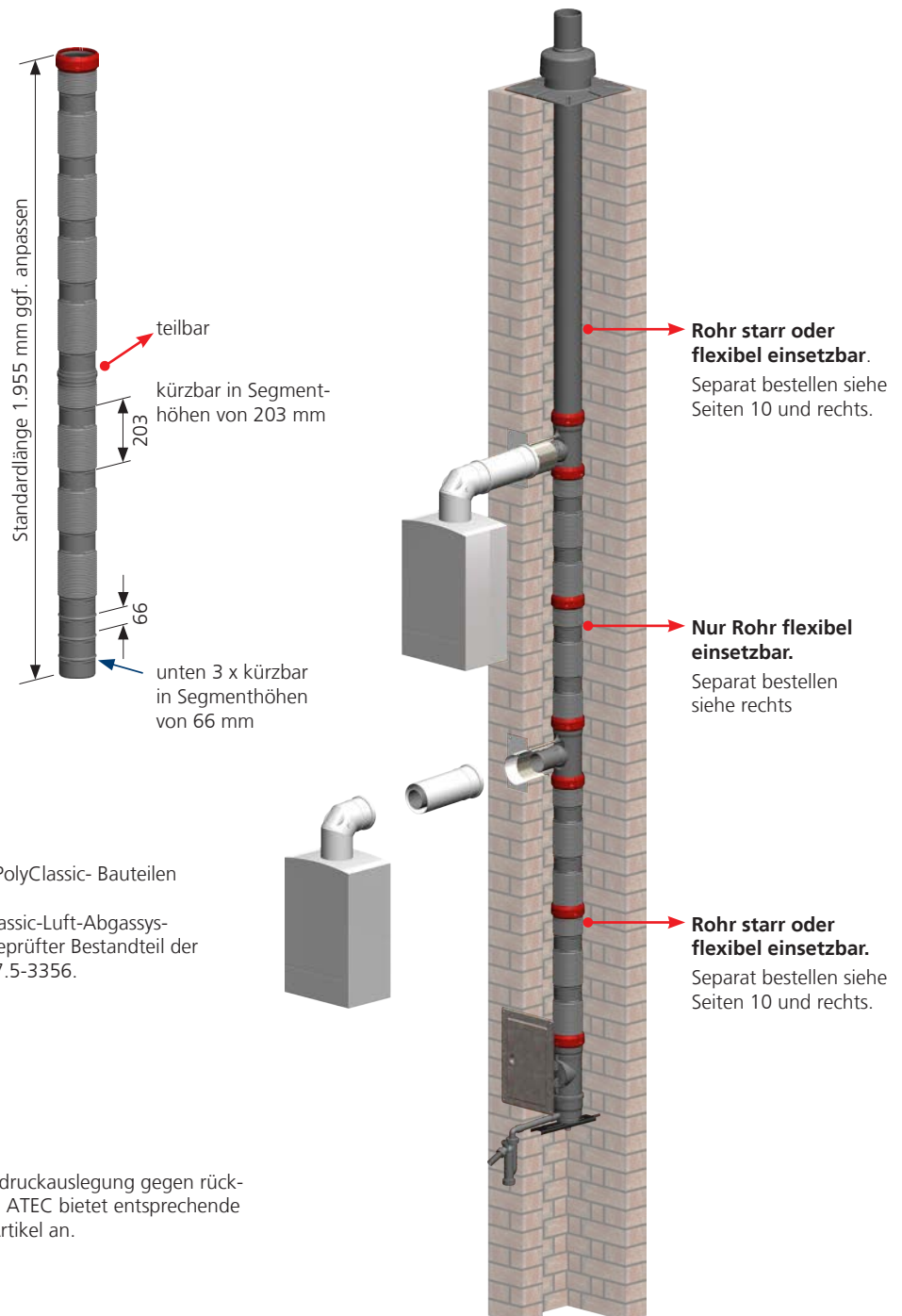

! Die Verbindungsleitung muss aus PolyClassic- Bauteilen erstellt werden.
Die Verbindungsleitung aus PolyClassic-Luft-Abgassystembauteile sind bauaufsichtlich geprüfter Bestandteil der Allgemeine Bauartgenehmigung Z-7.5-3356.

! Die Feuerstätten müssen bei Überdruckauslegung gegen rückströmende Abgase gesichert sein! ATEC bietet entsprechende Rückstromsicherungen als OEM-Artikel an.



Flyer Rückstromsicherung
Art.Nr. 10003143

DN 60/100 DN 80/125

87°-Kontroll-Bogen, konzentrisch



0401 € 130	1401 € 131
----------------------	----------------------

Kontroll-Rohr, konzentrisch



0403 € 104	1403 € 115
----------------------	----------------------

30°-Bogen, konzentrisch



0414 € 58	1414 € 58
---------------------	---------------------

45°-Bogen, konzentrisch



0415 € 59	1415 € 59
---------------------	---------------------

87°-Bogen, konzentrisch



0416 € 82	1416 € 83
---------------------	---------------------

Rohr, konzentrisch, kürzbar



Nutzlänge 255 mm

0417 € 45	1417 € 52
---------------------	---------------------

500 mm

0418 € 55	1418 € 61
---------------------	---------------------

955 mm

0419 € 72	1419 € 90
---------------------	---------------------

DN 100 DN 125

MFB Blinddeckel



0409 € 38	1409 € 58
---------------------	---------------------

DN 60 DN 80

Enddeckel mit Muffe



490065 € 33	490058 € 36
-----------------------	-----------------------

DN 80 DN 110

MFB Rohr flexibel 1955 mm



651322 € 101	653322 € 130
------------------------	------------------------

Bei Verwendung Rohr flexibel bis zur Mündung geeignete Flexrohraufhängung wählen, siehe Seite 20

MFB Kontroll-Rohr flexibel



651304 € 121	653304 € 146
------------------------	------------------------

DN 80 DN 110

MFB Basis-Set

- (1) Siphon und Kondensatschlauch 1,5 m
- (2) Kontroll-Rohr mit Kondensatablauf und Auflager
- (3) Bajonettverschluss
- (4) Flexrohrhülse
- (5) Mündungs-Set

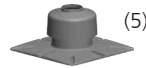

651389 € 248	653389 € 353
------------------------	------------------------



MFB Anschluss-Set

- (1) Schachtblende
- (2) Wandfutter
- (3) Rohr 255 mm
- (4) Schraubdeckel für T-Stück
- (5) T-Stück mit SV-Anschluss
- (6) Flexrohrhülse
- (7) Brandschutzkleber
- (8) Ergänzungs-Set MFB Rohr flexibel

DN 60/100	651392 € 284	653392 € 333
-----------	------------------------	------------------------

DN 80/125	651393 € 296	653393 € 345
-----------	------------------------	------------------------

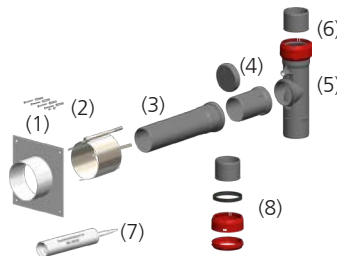

MFB Kondensatabführung über Schacht

- (1) Kondensatabführung
- (2) Bajonettverbindung
- (3) 0,5 m Schlauch 3/4"

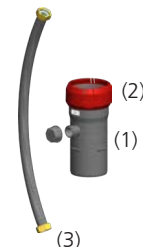

651394 € 205	653394 € 229
------------------------	------------------------

Kondensateinleitung in die Abgasleitung

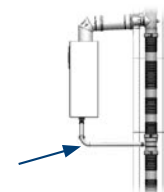

alle DN

Kondensatschlauchverbinder



601336 € 31

**Mehrfachbelegung DN 100, 125 und DN 160
Fixschellen-System**

**Abdeckplatte für Kopfverkleidung
(inkl. Mündungshaube)**

DN 100	DN 125	DN 160
300 x 300	300 x 300	350 x 350
300100 €290	300125 €302	350160 €329

 Die Feuerstätten müssen bei Überdruckauslegung gegen rückströmende Abgase gesichert sein! ATEC bietet entsprechende Rückstromsicherungen als OEM-Artikel an.



Flyer Rückstromsicherung
Art.Nr. 10003143

Feuerstättenanschluss DN 60/100

DN 100	DN 125	DN 160
632370 €264	634370 €300	636370 €321

Feuerstättenanschluss DN 80/125

DN 100	DN 125	DN 160
632371 €264	634371 €300	636371 €321

- (1) Eintauchstück
- (2) Schachtblende + Befestigungsset
- (3) Wandfutter + Inbusschraube
- (4) MFB T-Stück 87°

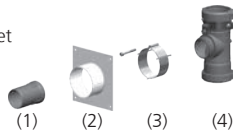

DN 100, 125 und 160 Flexrohr
als Set oder per Meter separat
bestellen siehe Seite 11.

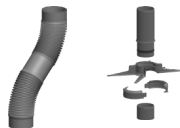

Kontroll-Rohr mit Kondensatablauf

DN 100	DN 125	DN 160
632349 €168	634349 €216	636349 €244

- (1) Siphon und Kondensatschlauch 1,5 m
- (2) Kontroll-Rohr mit Kondensatablauf
- (3) Fixschellen
- (4) Flexrohrhülse

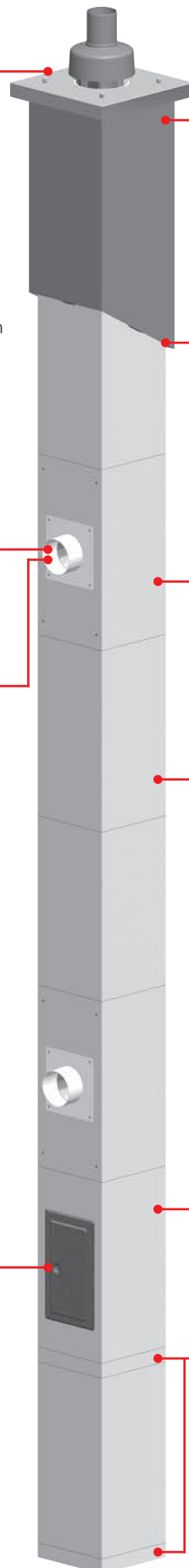
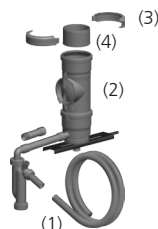

DN 100
DN 125
DN 160

Kopfverkleidung für Schacht (RAL 7016)

Für Außenmaß	300 x 300	350 x 350
	300009 €1229	350009 €1248

Nutzlänge 2000 mm

 Bei Verwendung für einen Fremdschacht mit abweichenden Maßen, muss die Kopfverkleidung bauseits unterfüttert werden. Siehe auch Seite 51.

Dacheindichtungsstreifen

300 x 3000 mm schwarz



242365
€155

Schachtelement für Feuerstättenanschluss

Innenmaß	200 x 200	250 x 250
	300004 €191	350004 €208

Nutzlänge 500 mm

Schachtelement

Außenmaß	300 x 300	350 x 350
Innenmaß	200 x 200	250 x 250
	300201 €80	350251 €88

Nutzlänge 500 mm

 PP-Innenrohre sind separat zu bestellen.

Kleber, Verarbeitung bis -8°C



ausreichend
lfdm

250900
€34

5,5 5,0

Schachtelement mit Kamintür

Innenmaß	200 x 200	250 x 250
	300003 €194	350003 €221

Nutzlänge 500 mm

Bodenplatte

Innenmaß	200 x 200	250 x 250
	300001 €70	350001 €77

Nutzlänge 50 mm

Mehrfachbelegung DN 80 und DN 110 Bajonett-System

Abdeckplatte für Kopfverkleidung
(inkl. Mündungshaube)

DN 80	DN 110
250 x 250	300 x 300
250080 €228	300110 €287

Die Feuerstätten müssen bei Überdruckauslegung gegen rückströmende Abgase gesichert sein! ATEC bietet entsprechende Rückstromsicherungen als OEM-Artikel an.



Flyer Rückstromsicherung
Art.Nr. 10003143

MFB Anschluss-Set PolyBit DN 60/100

DN 80	DN 110
651370 €285	653370 €303

MFB Anschluss-Set PolyBit DN 80/125

DN 80	DN 110
651371 €285	653371 €303

- (1) Eintauchstück
- (2) Schachtblende + Befestigungsset
- (3) Wandfutter + Inbusschraube
- (4) MFB T-Stück 87°

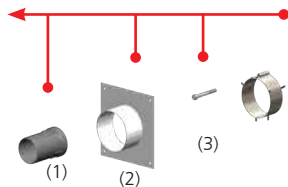

DN 80 und 110 Flexrohr als Stange separat bestellen siehe Seiten 41.

Kontroll-Rohr mit Kondensatablauf

DN 80	DN 110
651349 €160	653349 €197

- (1) Siphon und Kondensatschlauch 1,5 m
- (2) Kontroll-Rohr mit Kondensatablauf
- (3) Bajonettverschluss
- (4) Flexrohrhülse

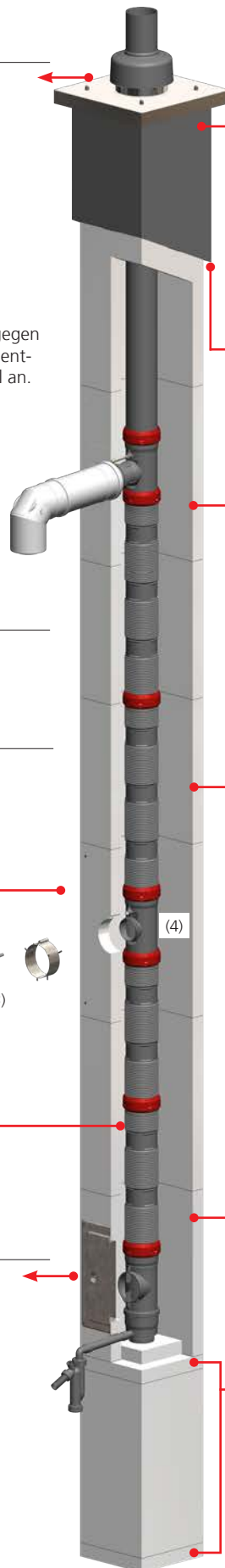
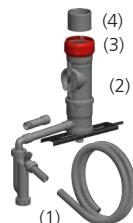

DN 80 DN 110

Kopfverkleidung für Schacht (RAL 7016)

Für Außenmaß 250 x 250 300 x 300

250009 €983	300009 €1229
-----------------------	------------------------

Nutzlänge 2000 mm

Bei Verwendung für einen Fremdschacht mit abweichenden Maßen, muss die Kopfverkleidung bauseits unterfüttert werden. Siehe auch Seite 51.

Dacheindichtungsstreifen

300 x 3000 mm schwarz



242365 €155

Schachtelement für Feuerstättenanschluss

Innenmaß 150 x 150 200 x 200

250004 €168	300004 €191
-----------------------	-----------------------

Nutzlänge 500 mm

Schachtelement

Außenmaß 250 x 250 300 x 300

Innenmaß 150 x 150 200 x 200

250151 €68	300201 €80
----------------------	----------------------

Nutzlänge 500 mm

PP-Innenrohre sind separat zu bestellen.

Kleber, Verarbeitung bis -8°C



ausreichend lfdm

250900 €34

6,0 5,5

Schachtelement mit Kamintür

Innenmaß 150 x 150 200 x 200

250003 €168	300003 €194
-----------------------	-----------------------

Nutzlänge 500 mm

Bodenplatte

Innenmaß 150 x 150 200 x 200

250001 €62	300001 €70
----------------------	----------------------

Nutzlänge 50 mm

MEHRFACHBELEGUNG

ATEC | ABGASSYSTEME

Mehrfachbelegung

Allgemeine Bauartgenehmigung Nr. Z-5.3356 für Gasgeräte



[Link zum Video](#)

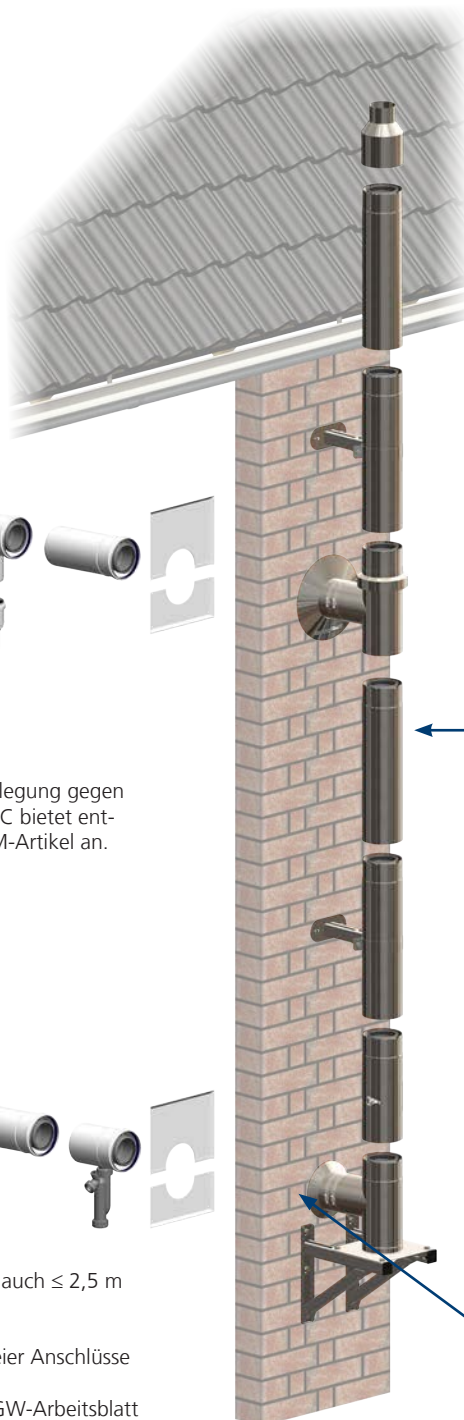

WhitePoly Sets und Bauteile ab Seite 24

IronPoly Sets und Bauteile ab Seite 26

← Kompensatorelement unter jeden Geräteanschluss

 Die Feuerstätten müssen bei Überdruckauslegung gegen rückströmende Abgase gesichert sein! ATEC bietet entsprechende Rückstromsicherungen als OEM-Artikel an.



[Flyer Rückstromsicherung](#)
Art.Nr. 10003143



Hinweis:

Die Abstände zwischen den Anschlüssen können auch $\leq 2,5$ m sein wenn:

- Alle Geräte von einem Hersteller sind.
- Ein Nachweis für verminderte Abstände zweier Anschlüsse als Bauartprüfung C (11) vorliegt.
- Alle anderen Anforderungen nach dem DVGW-Arbeitsblatt G 635 erfüllt sind.

Vgl. auch DVGW-Arbeitsblatt, Ziffer 4.2.

 Im Bereich der Wanddurchführung ist White/IronPoly zu verwenden.

DN 80/125 DN 100/150 DN 110/160 DN 125/190 DN 160/230

Anschluss T-Stück für Mehrfachbelegung mit Zuluftansaugung (Edelstahl weiß)



D80/125

Nutzlänge	711704 €265	712704 €318	713704 €352
	275 mm	275 mm	318 mm

Kompensatorelement (Edelstahl weiß)



Nutzlänge	711721 €142	712721 €200	713721 €237
	940 mm	940 mm	940 mm

Anschlussbogen mit Zuluftansaugung (Edelstahl weiß)



D80/125

Nutzlänge	711734 €296	712702 €318	713702 €352
	86 mm	97 mm	101 mm

Verankerungsplatte (Edelstahl weiß)

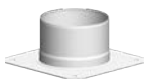

Maße (mm)	711733 €94	712733 €97	713733 €120
	195 x 195	195 x 195	235 x 235

Anschluss T-Stück für Mehrfachbelegung mit Zuluftansaugung (Edelstahl blank)



D80/125

Nutzlänge	701704 €264	702704 €317	703704 €351	704704 €424	706704 €493
	275 mm	275 mm	318 mm	275 mm	445 mm

Kompensatorelement (Edelstahl blank)



Nutzlänge	701721 €141	702721 €199	703721 €237	704721 €276	706721 €332
	940 mm	940 mm	940 mm	940 mm	940 mm

Anschlussbogen mit Zuluftansaugung (Edelstahl blank)



D80/125

Nutzlänge	701734 €294	702702 €317	703702 €351	704702 €380	706702 €424
	86 mm	97 mm	101 mm	101 mm	134 mm

Verankerungsplatte (Edelstahl blank)

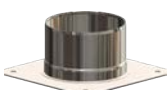

Maße (mm)	701733 €94	702733 €97	703733 €120	704733 €125	706733 €128
	195 x 195	195 x 195	235 x 235	260 x 260	320 x 320

ABGAS - SCHACHT

ATEC | ABGASSYSTEME

Abgassystem mit Brandschutz L_A 30, lieferbar in DN 60 und in DN 80 in **deckengestützter Bauweise** für den Anschluss von raumluftunabhängigen und raumluftabhängigen Gas- und Öl-Brennwertgeräten mit Abgastemperaturen ≤120 °C sowie BHKW-Anlagen mit Abgastemperaturen ≤100 °C. Schächte mit Schutzziel L_A 90 siehe nächste Doppelseite. ☞ Die Innenrohre sind jeweils separat zu bestellen.

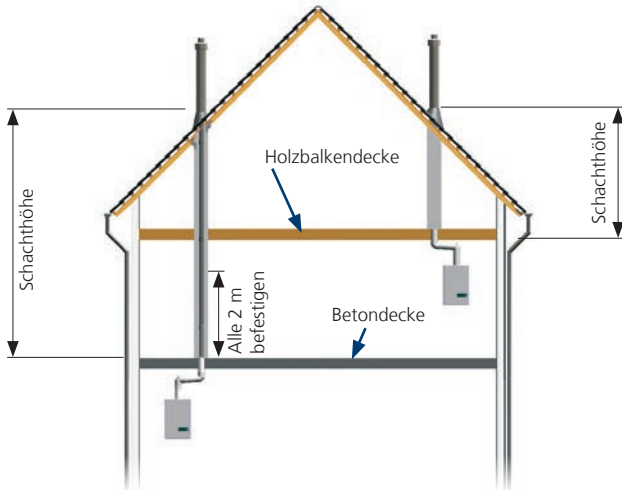

Planungsweise:

Der Bedarf für PolyCase-Schächte errechnet sich **ab Oberkante Betondecke bzw. ab Unterkante Holzdecke bis Oberkante Dachpfanne**. Bei Bestellung eines **Kontroll-Rohr-Sets** sind **von der Schacht- und Abgasleitungshöhe 600 mm in Abzug** zu bringen.

Die Höhe der Dachhochführung beträgt für DN 60 und DN 80 650 mm und für DN 100 1.100 mm.

Beachten Sie bei der Dachhochführung die Dachstein- bzw. Ziegelfarbe.

Die Schächte sind alle 2 Meter an den Wänden gegen seitliches Verschieben mit Sicherungswinkel oder Wandbefestigungs-Sets zu befestigen. Die Deckendurchführung ist hierbei eine gleichwertige Führung.

Die Abgasanlagen können **ohne Brandsicherheitsabstände gegenüber brennbaren Baustoffen** eingebaut werden.

Bauelemente für Verbindungsleitungen bitte gemäß Preisliste Seite 18 (PolyClassic) oder Seite 19 (PolyTwin) bestellen.

Basis-Set PolyCase für Beton-/ Holzdecken

- (1) Verankerungsplatte mit Anschlussrohr und Schelle
- (2) PP-Rohr 255 mm
- (3) 2 x Sicherungswinkel inkl. Spax-Schrauben

- (4) 1,0 kg Brandschutzkleber (ausreichend für 20 geschlossene Elemente oder 5 offene Elemente)
- (5) 3 x Abstandhalter (je in zwei Größen)
- (6) 4 x Alu-Verschlusssetketten
- (7) 6 x Tellerkopfschraube+Universaldübel

DN 60/100

240370
€215

DN 80/125

241370
€220

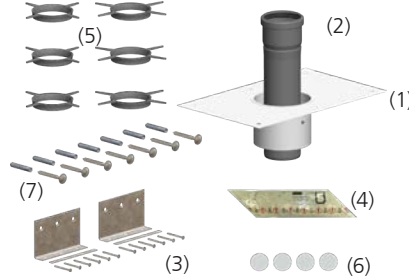

Weitere Sicherungswinkel und/oder Wandbefestigungs-Sets sind in Abhängigkeit der Schachthöhen und Wandabstände zusätzlich zu bestellen.

Abstandhalter, Bedarf alle 2 - 3 m VPE 4 Stück

DN 60

240353
€32

DN 80

241353
€32



87°-Bogen mit Kontrollöffnung im Zuluftrohr

PP/Stahl weiß PP/PP weiß

DN 60/100

240501
€67

DN 80/125

241401
€111



DN 60/L_A30 DN 80/L_A30

Außenmaß (mm)

150 x 200

150 x 200

Innenmaß (mm)

100 x 150

100 x 150

Schachtelement 1.150 mm, inkl. Steckverbinder



241319
€212

241319
€212

Schachtelement 600 mm, inkl. Steckverbinder



241318
€139

241318
€139

30°-Schachtwinkel, einseitig offen, inkl. Steckverbinder

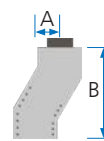

Versatzmaß A
in mm B

251314
€215

251314
€215

112

112

417

417

45°-Schachtwinkel, einseitig offen, inkl. Steckverbinder

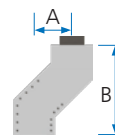
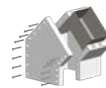

Versatzmaß A
in mm B

251315
€215

251315
€215

179

179

432

432

Kontroll-Rohr-Set

1 x Kamintür
1 x Kontroll-Rohr

1 x Schachtelement 600 mm, einseitig offen, inkl. Steckverbinder



240303
€419

241303
€425

Dachhochführung, konzentrisch, passend zur Schachtgröße

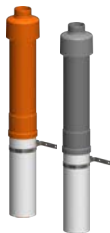

ziegelrot
650 mm über Dach

schwarz
650 mm über Dach

installierte Höhe

240457
€193

241457
€220

240458
€193

241458
€220

650 mm

650 mm



Flachdachkragen und Schrägdachpfannen siehe Seiten 22 und 23.

Steckverbinder für Schachtbauteile als Ersatzteil



298038
€27

298038
€27



Bei raumluftabhängiger Betriebsweise muß der Schacht durch die Dachhaut geführt werden und bei Innenrohr DN80 ein geeigneter Schacht aus dem L_A90 Programm verwendet werden.

Abgassystem mit Brandschutz L_A 90 in DN 80 und DN 100 in **deckengestützter Bauweise (Landesbaurecht beachten, Rücksprache mit dem bevollmächtigten Bezirksschornsteinfeger erforderlich)** sowie in DN 60 bis 250 in **bodengestützter Bauweise** für den Anschluss von raumluftunabhängigen und raumluftabhängigen Gas- und Öl-Brennwertgeräten mit Abgastemperaturen ≤120 °C sowie BHKW-Anlagen mit Abgastemperaturen ≤100 °C, Brandschutz L_A 90. Die Innenrohre sind jeweils separat zu bestellen.

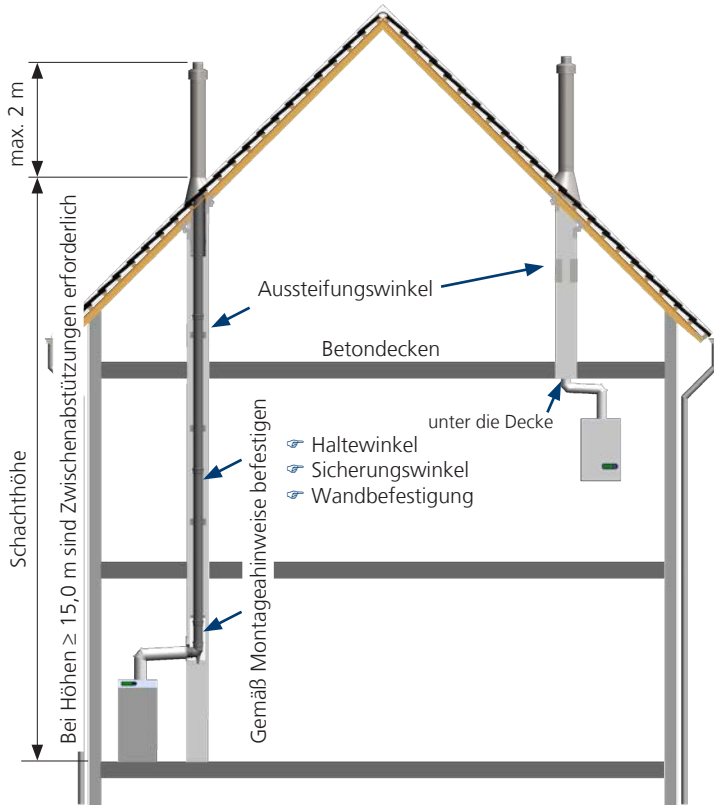

Planungsweise:

Deckengestützte Bauweise siehe bei Brandschutz L_A 30.

Der Bedarf für PolyCase-Schächte errechnet sich **ab Oberkante Rohfußboden** im Heizgeräteaufstellraum **bis Oberkante Dachpfanne** **./.600 mm** für das **Schachtelement mit Feuerstättenanschluss**.

Bei Bedarf zusätzlicher Kontrollöffnungen im senkrechten Schachtabschnitt, sind **je Kontrollöffnung 600 mm Höhe von der Gesamtschachthöhe abzuziehen**.

Die Mündungshöhe über Dach kann ab DN 100 ohne Zusatzmaßnahmen bis zu 2,0 m betragen. Bei größeren Höhen sind zusätzliche, starre Abspannungen zur Windlastableitung erforderlich!

Die Schächte sind gemäß Montageanleitung, in den angegebenen max. Abständen (1,5 bis 3,0 m) an den Wänden und in den Decken gegen seitliches Verschieben mit Sicherungswinkeln oder Wandbefestigungs-Sets zu befestigen. Die Deckendurchführung ist hierbei eine gleichwertige Führung.

Die Abgasanlagen können **ohne Brandsicherheitsabstände** gegenüber brennbaren Baustoffen eingebaut werden.

Die bodengestützten Schächte erfüllen L_A 90 Brandschutzziele. Bauelemente für Verbindungsleitungen bitte je nach Bedarf ab Seite 8 unter PolyTop, PolyClassic oder PolyTwin bestellen.

Tab. PolyCase-Schachtgewichte

DN	Schachtgewicht
60+80/L _A 90	15,0 kg / stgm
100+110/L _A 90	19,0 kg / stgm
125/L _A 90	23,0 kg / stgm
160/L _A 90	26,0 kg / stgm
200/L _A 90	30,0 kg / stgm
250/L _A 90	37,0 kg / stgm

L_A 90 Basis-Set PolyCase für Betondecken

- (1) Verankerungsplatte mit Anschlussrohr und Schelle
- (2) PP-Rohr

DN 80/125	241370 €220
DN 100/150	242370 €419
DN 110/160	243370 €505

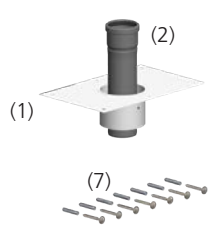

- (3) 2 x Sicherungswinkel inkl. Spax-Schrauben
- (4) 1,0 kg Brandschutzkleber

- (5) 3 x Abstandhalter (je in zwei Größen)
- (6) 4 x Alu-Verschlussketten
- (7) 6 x Tellerkopfschraube+Universaldübel

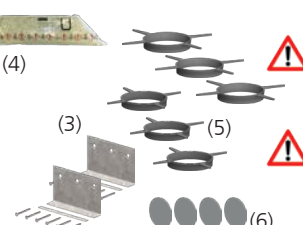

Weitere Sicherungswinkel und/oder Wandbefestigungs-Set sind in Abhängigkeit der Schachthöhen und Wandabstände zusätzlich zu bestellen.

Diese Anschlussart ist im Planungsstadium mit dem bevollmächtigten Bezirksschornsteinfeger abzustimmen.



L_A 90 Basis-Set PolyCase für Bodenmontage, DN 80 bis DN 250

- (1) Sparrenhalter-Set PolyCase (kein Lieferumfang bei DN 60 und DN 80)
- (2) Schachtelement 600 mm für Anschluss der Feuerstätte inkl. ATEC-Schachteinführung
- (3) Wandblende für Gleich- und Gegenstrombetriebsweise

DN 60	240334 €580	200 x 200	120 x 120	680 mm
DN 80	241334* €644	200 x 200	120 x 120	680 mm
DN 100	242334 €794	240 x 240	160 x 160	680 mm
DN 110	243334* 851	240 x 240	160 x 160	680 mm
DN 125	244334 €939	280 x 280	200 x 200	680 mm
DN 160	246334 €1008	310 x 310	230 x 230	680 mm
DN 200	248334 €1174	350 x 350	270 x 270	680 mm
DN 250	249334 €1328	420 x 420	340 x 340	680 mm

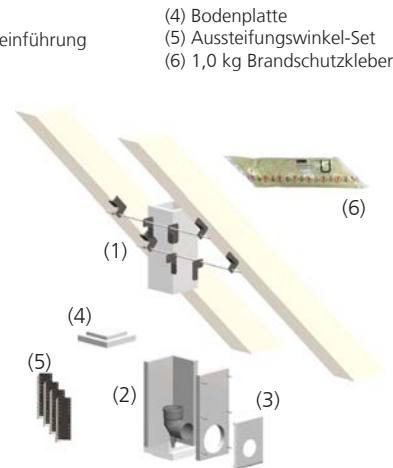

87°-Bogen mit Kontrollöffnung im Zulufrohr siehe Seite 46

Die Zuordnungen der Schachtabstände setzen eine strömungstechnische Berechnung nach EN 13384 für raumluftunabhängigen Betrieb voraus.

***Für raumluftabhängigen Betrieb müssen bei Abgasleitungen in DN 80 und 110, nach dem Baurecht, größere lichte Schächte notwendig werden.** In diesem Fall muss der Schacht durchgängig geführt werden.

! Dachhochführung für DN 80 und DN 100 siehe Seite 50. Klebverbrauch siehe Seite 49.

	DN 60/L _A 90	DN 100/L _A 90	DN 125/L _A 90	DN 160/L _A 90	DN 200/L _A 90	DN 250/L _A 90
	DN 80/L _A 90*	DN 110/L _A 90*	*Bei raumluftabhängiger Betriebsweise nächstgrößeren Schacht verwenden.			
Außenmaß (mm)	200 x 200	240 x 240	280 x 280	310 x 310	350 x 350	420 x 420
Innenmaß (mm)	120 x 120	160 x 160	200 x 200	230 x 230	270 x 270	340 x 340

Kontroll-Rohr-Set

Kamintür

Schachtelement 600 mm, einseitig offen, inkl. Steckverbinder

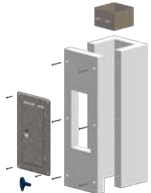

PP-Innenrohre sind separat zu bestellen.

241403 €358	242403 €403	244403 €507	246403 €557	248403 €650	249403 €846
-----------------------	-----------------------	-----------------------	-----------------------	-----------------------	-----------------------

Die Zuordnungen der Schachtquerschnitte setzen eine strömungstechnische Berechnung nach EN 13384 für raumluftunabhängigen Betrieb voraus. Für raumluftabhängigen Betrieb können bei Abgasleitungen in DN80 bis 110, nach dem Baurecht, größere lichte Schächte notwendig werden.

Brandschutzkleber Inhalt 1 kg

Kleberverbrauch bei 1,0 kg:



geschlossene Elemente (Stück)
einseitig offene Elemente (Stück)

	239001 €26					
geschlossene Elemente (Stück)	19	15	12	11	9	8
einseitig offene Elemente (Stück)	4	4	3,5	3,5	3	3

Schachtelement 1.195 mm, einseitig offen, inkl. Steckverbinder

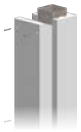

251419 €331	252419 €383	254419 €436	256419 €481	258419 €535	259419 €631
-----------------------	-----------------------	-----------------------	-----------------------	-----------------------	-----------------------

Schachtelement 1.195 mm, inkl. Steckverbinder



241419 €309	242419 €361	244419 €414	246419 €458	248419 €513	249419 €612
-----------------------	-----------------------	-----------------------	-----------------------	-----------------------	-----------------------

Schachtelement 600 mm, inkl. Steckverbinder



241418 €182	242418 €210	244418 €242	246418 €264	248418 €292	249418 €346
-----------------------	-----------------------	-----------------------	-----------------------	-----------------------	-----------------------

30°-Schachtwinkel, einseitig offen, inkl. Steckverbinder

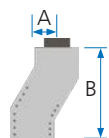
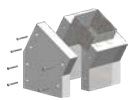

Versatzmaß A
in mm B

	251414 €234	252414 €279	254414 €296	256414 €320	258414 €347	259414 €389
Versatzmaß A	112	117	123	127	132	141
in mm B	417	437	457	472	492	527

45°-Schachtwinkel, einseitig offen, inkl. Steckverbinder

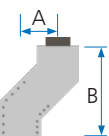
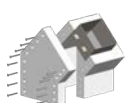

Versatzmaß A
in mm B

	251415 €234	252415 €279	254415 €295	256415 €320	258415 €347	259415 €389
Versatzmaß A	179	191	202	211	223	243
in mm B	432	460	488	509	538	587

Steckverbinder für Schachtbauteile als Ersatzteil



298039 €30	298040 €32	298041 €35	298042 €37	298043 €40	298044 €46
----------------------	----------------------	----------------------	----------------------	----------------------	----------------------



Lieferzeit ab DN 125/L_A90 für alle Bauteile 4 Wochen.

DN 60/100 DN 80/125 DN 100/150 DN 125/190 DN 160/215 DN 200/265 DN 250/315

Mündungs-Set PolyCase DN 100 bis 250 (Edelstahl)

(1) Mündungsabschluss 620 mm
(2) Mündungslänge 940 mm

(ohne Innenrohr)
(ohne Innenrohr)

(3) Schachtheadapter 1180 mm
(4) 2 x Sparrenwinkel

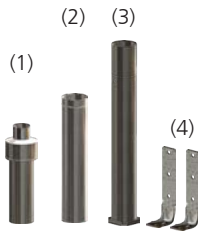

max. Inst. Höhe über Dach
ohne weitere Abspannung

242354 €865	244354 €959	246354 €1041	248354 €1128	249354 €1426
-----------------------	-----------------------	------------------------	------------------------	------------------------

1.600 mm	1.600 mm	1.600 mm	1.600 mm	1.600 mm
----------	----------	----------	----------	----------

Mündungsverlängerung 940 mm L_A90



242490 €108	244490 €139	246490 €152	248490 €208	249490 €231
-----------------------	-----------------------	-----------------------	-----------------------	-----------------------

Flachdachdurchführung 0° - 5° inkl. Wetterkragen



704666 €243	246666 €259	708666 €369	709666 €416
-----------------------	-----------------------	-----------------------	-----------------------

Flexible Flachdachdurchführung bis 20° (inklusive Schrauben und Kleber)

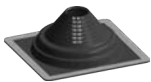

701610 €255	702610 €255
-----------------------	-----------------------

Grundfläche 270 x 290 mm

375 x 415 mm

Verwendbar für Blech-, Trapezblech und Faserzementdächer

Dachdurchführung 6° - 32° inkl. Wetterkragen



702663 €373	704768 €425	706663 €439	708663 €561	709663 €609
-----------------------	-----------------------	-----------------------	-----------------------	-----------------------

Dachdurchführung 33° - 45° inkl. Wetterkragen (steilere Dachneigung auf Anfrage)



702664 €373	704769 €425	706664 €439	708664 €561	709664 €609
-----------------------	-----------------------	-----------------------	-----------------------	-----------------------

Blower door-Set

Entsprechend gewünschtem Überdachabschluss
Schacht mit Kopfverkleidung schützen oder
bauseits entsprechend der Dachneigung bis
Unterkante Dachdeckung kürzen

241381 €224

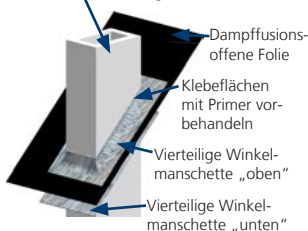

Verpackungsinhalt:
Klebebandrolle Abmessung: B x L = 152,4 x 5710 mm
Primer 250 mg

Dachhochführung, konzentrisch, passend zu Schachtabmessungen



ziegelrot	240557 €188	241557 €220	242457 €380
schwarz	240558 €188	241558 €220	242458 €380
inst. Höhe über Dach	650 mm	650 mm	1.100 mm



Nicht für raumluftabhängigen Betrieb geeignet



Flachdachkragen und Schrägdachpfannen siehe Seiten 22 und 23.



Lieferzeit ab DN 125/L_A90 4 Wochen.

	DN 60	DN 80	DN 100	DN 125	DN 160	DN 200	DN 250
Abstandhalter , Bedarf alle 2 - 3 m							
4 Stück	240352 €32	241352 €32	242352 €41				
							
1 Stück				244352 €49	246352 €52	248352 €54	249352 €57
				ab DN 125 aus Edelstahl			

für alle DN

Aussteifungswinkel-Set inkl. 80 Spax-Schrauben (300 mm lang)

(1) 	249904 €128
---	----------------

Haltewinkel inkl. Schrauben

(2) 80 x 60 x 150 mm 	249905 €101
--	----------------

Sicherungswinkel inkl. Schrauben, für Wandabstände < 20 mm, für verdeckte und seitliche Montage

(3) 	129902 €31
--	---------------

Wandbefestigungs-Set, für Wandabstände > 20 mm

(4) 40 x 300 mm 	249903 €38
---	---------------

Sparrenhalter-Set

(5) 	129901 €136
---	----------------

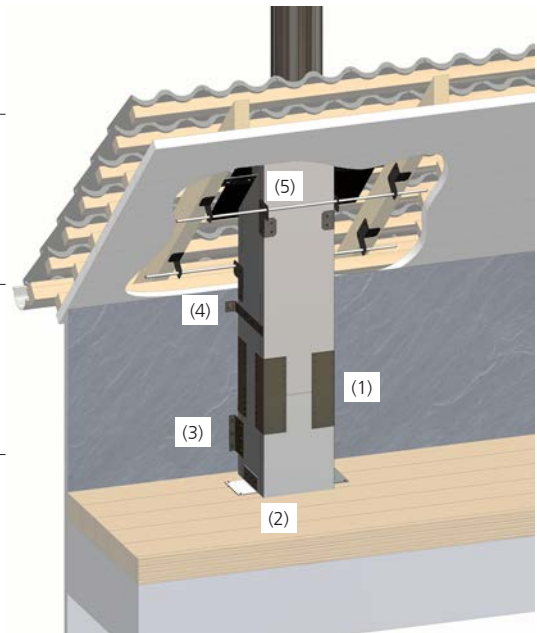

Mögliche Verwendung der Winkel

	DN 60/L _A 90	DN 80/L _A 90	DN 100/L _A 90	DN 110/L _A 90	DN 125/L _A 90	DN 160/L _A 90	DN 200/L _A 90	DN 250/L _A 90
Für Außenmaß des Schachtes (mm)	200 x 200	200 x 200	240 x 240	240 x 240	280 x 280	310 x 310	350 x 350	420 x 420

Abdeckplatte für Kopfverkleidung (inkl. Mündungshaube)

	200060 €234	250080 €228	250100 €257	250110 €282	300125 €302	350160 €329	350200 €349	420250 €387
	Abdeckplatte Edelstahl, Mündungshaube PP							

Kopfverkleidung

	200009 €890	200009 €890	250009 €983	250009 €983	300009 €1229	350009 €1248	350009 €1248	420009 €1377
---	----------------	----------------	----------------	----------------	-----------------	-----------------	-----------------	-----------------

Nutzlänge 2000 mm

 Bei Verwendung für einen Fremdschacht mit abweichenden Maßen, muss die Kopfverkleidung bauseits unterfüttert werden. Siehe auch Seite 43.

Außen Aluminium Anthrazitgrau

 Lieferzeit ab DN 125/L_A 90 4 Wochen.

ABGAS – WÄRMETAUSCHER

ATEC | ABGASSYSTEME

Abgaswärmetauscher GPH AK

Abgaswärmetauscher GPH AK 28
raumlufatabhängig



[Link zum Video](#)

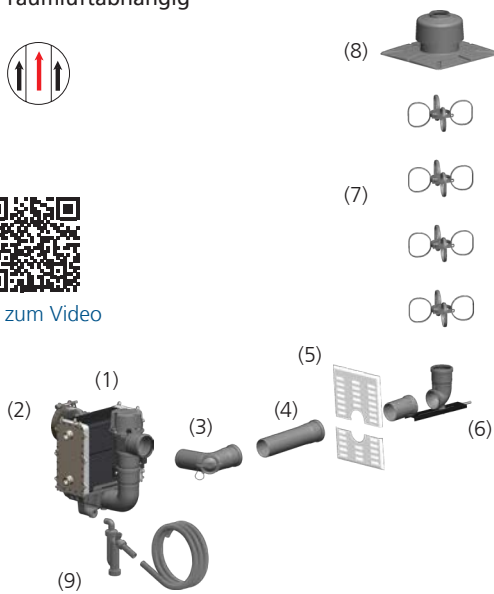

eMAX Abgaswärmetauscher GPH AK 28 Set

- (1) Wärmetauscher inkl. Abgasgebläse und Sicherungseinrichtung
- (2) Kesseladapter Ø 130 mm
- (3) 87°-Kontroll-Bogen DN 80
- (4) Rohr 500 mm DN 80
- (5) Wandblende mit Hinterlüftung DN 80
- (6) SV-Schachteinführung mit Auflager DN 80
- (7) Abstandhalter DN 80, 4x
- (8) Mündungs-Set DN 80
- (9) Siphon

Mündungs-Set aus Kunststoff GPH AK 28 kW

801001
€2004

Mündungs-Set aus Edelstahl GPH AK 28 kW

801003
€2148

Kesseladapter Ø 150 mm inkl. Dichtung und Spanschelle

801034
€171

bedingt raumlufunabhängig

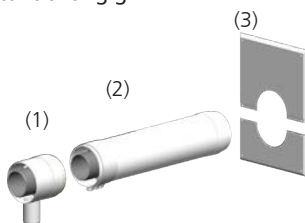

Ergänzungs-Set GPH für Zuluftansaugung über den Schacht

- (1) Adapter für Zuluftansaugung (Anschluss 50 mm, Verbindung zum Brenner -> bauseits) DN 80/125
- (2) Rohr 500 mm DN 80/125
- (3) Wandblende geschlossen DN 80/125

GPH AK 28 kW

PolyTwin

801110
€154

Abgaswärmetauscher GPH HP

Der GPH HP ist ein Abgaswärmetauscher für Blockheizkraftwerke bis 5000 Pa Förderdruck.



eMAX Hochdruck-Abgaswärmetauscher bis 5.000 Pa

- 4 x Heizungsanschluß R 1" AG
- Feuerstättenanschluss (Stutzen da 60 mm)
- Abgasmuffe DN80
- Revisionsdeckel
- Heizungs-Entlüfter manuell
- Kondensatablauf 1" AG; Schlauch 21i/25a mm
- Siphon mit Sperrkugel, mit Auslauf D40
- ohne Abgastemperaturbegrenzer

Typ eMAX GPH HP 28

801015
€ 1972



Für den sicheren Betrieb ist ein Abgastemperaturbegrenzer einzusetzen.

Verlängerung (kürzbar)

GPH AK 28

801021
€ 38



Baulänge:
250 mm

Z-Verlängerung

GPH AK 28

801031
€ 202



Seitlicher Versatz:
100 mm
Baulänge:
150 mm

Kondensatbox, bis 30 kW, für Gas- oder Öl-Brennwert, inklusive Füllung

601129
€ 144



Kann bei schwefelarmen Öl und Gas entfallen, Vorgaben der unteren Wasserbehörde beachten.

Standfuß

GPH AK/HP 28

801080
€ 361



Ersatz Gebläserad

GPH AK 28

801823
€ 22

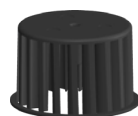

Flansch + Dichtung mit 1 Zoll AG für Wolf/Viessmann

(ältere Kessel)

801041
€ 37



Flexschlauch Anbindung

GPH AK/HP 28

801042
€ 37

Baulänge: 300 mm

GPH AK/HP 28

801043
€ 28



450 mm

Überwurfmutter: G1

Winkelverschraubung G1 AG x G1 ÜM

801051
€ 20



Wartungs-Set

GPH AK/HP 28

801070
€ 35

GPH AK/HP 50

801071
€ 39



Siphon-Set

801060
€ 43



Abgastemperaturbegrenzer-ATB-Set

für die

DN 80

GPH HP 28

601602
€ 510



Kraftschluss-Manschetten

Zum einfachen Anschluss unterschiedlicher Durchmesser bis zu 43 mm von z.B. PP-Rohren an Kesselstützen, Edelstahl-Schalldämpfer oder Edelstahl-Rohre, für Brennwertanlagen geeignet. Darüber hinaus können mit den Kraftschluss-Manschetten alle runden Rohrverbindungen dauerhaft und dicht im Indoor- und Outdoorbereich verbunden werden.

Kraftschluss-Manschette



Preisgruppe 15	601421 €105	601422 €127	601423 €138	601424 €171	601425 €193	601426 €275	601427 €319
Spannbereich in mm:	40-65	50 - 80	75-110	100-133	123-161	160 - 192	183 - 226
Gesamtlänge in mm:	85	85	85	130	130	130	130
Nutzlänge in mm:	0	0	0	0	0	0	0

Temperaturbeständig bis 120°C
Überdruckdicht bis 150.000 Pa = 1,5 bar

SCHALLDÄMPFER

Schalldämpferprogramm Neuheiten und Highlights

■ Unterschiedliche Dämpfetechniken

Das umfangreiche Schalldämpfer-Programm beinhaltet verschiedene Dämpfetechniken wie Absorption, Reflexion und Resonanz. Eine Schallpegelminderung kann somit bereits ab 40 Hz erzielt werden.

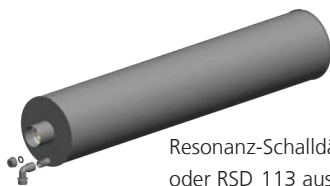

Resonanz-Schalldämpfer RSD 110
oder RSD 113 aus PP

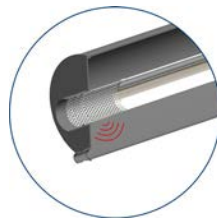

■ Kombi für breite Schalldämpfung

Darüber hinaus kann mit einer Kombination aus den neuen Resonanz-Schalldämpfern RSD 110 oder RSD 113 und einem Absorptions-Schalldämpfer ASD eine sehr breitbandige Dämpfung ohne nennenswerten Druckverlust ermöglicht werden.



Resonanz-Schalldämpfer RSD-FL 113
mit Alu-Flansch aus Edelstahl

Das Schalldämpferprogramm finden Sie in unserer separaten **Preisliste (Art. Nr. 10003680)** auf unserer Homepage im Downloadbereich. Fordern Sie diese gerne an oder fragen Sie unsere Fachberatung.



EDELSTAHL-SYSTEME

ATEC Abgassysteme aus Edelstahl

- **Sanierung (Einwandige Systeme)**
- **Neubau (Doppelwandige Systeme)**
- **Objekte (Durchmesser bis 600 mm)**

Unsere Edelstahlsysteme sind vielseitig einsetzbar und bieten eine hohe Flexibilität auch für die Realisierung schwieriger Einbausituationen. Hiermit bietet ATEC nun auch eine Lösung für die Beheizung mit festen Brennstoffen, wie z.B. mit Pellets.

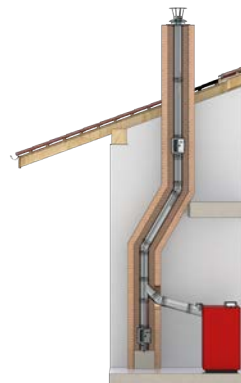

Das umfangreiche Edelstahlprogramm finden Sie in unserer separaten **Preisliste (Art.Nr. 10001479)** auf unserer Homepage im Downloadbereich. Fordern Sie diese gerne an oder fragen Sie unsere Fachberatung.





Wir bitten um Zusendung folgender Unterlagen:

Absender:

_____ Stück Preisliste(n)

Anlage bereits installiert: DN _____

Angebot/Materialaufstellung

Querschnittsberechnung nach DIN EN 13384

Postleitzahl und Einbauort der Feuerstätte: _____

Hersteller der Feuerstätte: _____

Typ: _____

Leistung: _____ Anzahl der Feuerstätten

Betriebsweise: raumluftabhängig Mehrfachbelegung Kondensatabführung üb. Schacht
 Abstände zwischen den Geräten: _____ m
 Abstand oberstes Gerät bis Mündung: _____ m
 raumluftunabhängig Kaskade

Umlenkungen in der Verbindungsleitung: _____ x 87°-Kontroll-Bogen
 _____ x 87°-Bogen
 _____ x 45°-Bogen
 _____ x 30°-Bogen

Gestreckte Länge der Verbindungsleitung: _____ m

Skizze:

Gestreckte Länge der Steigleitung: _____ m

Kontrollöffnung im Dachgeschoss: ja

Schachtgröße (mm): Ø _____ x _____

Mündungsset aus Edelstahl: ja

Rohr flexibel: ja

Schachtsystem PolyCase: ja L_A30 L_A90

Außenwandmontage WhitePoly: ja Wandabstand: _____ mm

Außenwandmontage IronPoly: ja Wandabstand: _____ mm

Sonderoberfläche: ja _____

Datum: _____

Kunden-Kommission: _____

Kunden-Bestell-Nummer: _____

Zuständig: _____

Termin: _____

Übersicht Heizgeräte – Abgasquerschnitte – max. Leitungslängen

Der Durchmesser der Abgasführung ergibt sich aus:

1. der eingesetzten Feuerstätte mit benötigter Leistung
2. Umlenkungen im Verbindungsstück
3. Summe der gestreckten Länge der Verbindungsstück und Steigleitung
4. raumluftabhängiger oder raumluftunabhängiger Betriebsweise
5. vorhandenen lichten quadratischen/gleichwertigen hydraulischen Schachtabmessungen

Zur Vereinfachung der Querschnittsbestimmung sind in der Übersicht folgende Rahmenbedingungen berücksichtigt:

• Schachtmaße:	DN 60	Ø 135 mm	▣ 115 x 115 mm
	DN 80	Ø 154 mm	▣ 134 x 134 mm
	DN 100	Ø 175 mm	▣ 155 x 155 mm
	DN 110	Ø 188 mm	▣ 168 x 168 mm
	DN 125	Ø 206 mm	▣ 186 x 186 mm
	DN 160	Ø 244 mm	▣ 224 x 224 mm
	DN 200	Ø 282 mm	▣ 262 x 262 mm
	DN 250	Ø 334 mm	▣ 314 x 314 mm

- gestreckte Länge der Verbindungsleitung 1,5 m
- Umlenkungen in der Verbindungsleitung: 2 x 87°

Die Schachtmaße können bei raumluftunabhängiger Betriebsweise je nach Kesseltyp auch geringer sein.

Bei zusätzlichen Umlenkungen verringert sich die gestreckte Baulänge um:

- 0,3 m je 30°-Bogen
- 0,5 m je 45°-Bogen
- 0,8 m je 87°-Bogen

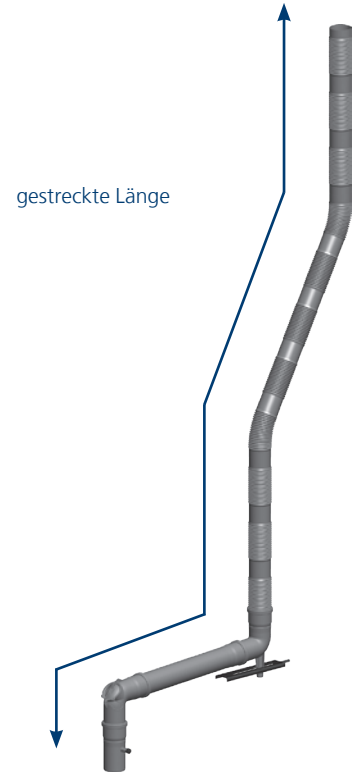



Hersteller / Typ	Anschlussstück Kesselhersteller	ATEC Anschlussadapter		Verbindungs- leitung	Steigleitung einwandig	Schachtabmessungen	
		gerade	87°-Bogen			konzentrisch	Außenwandmontage
ABC	xxxxxx	1220	1219	80	80 - 20(16)		80/125 - 16
Hersteller	Gibt an, ob ein Messelement oder Adapter vom Kesselhersteller eingesetzt werden muss	Gerades Kesselanschlussbauteil/Übergang	87°-Kesselanschlussbauteil/Übergang	DN 80 = Durchmesser des Verbindungsstücks	DN 80 = Durchmesser der Steigleitung 20 = maximale gestreckte Länge der Abgasführung in m (16) = maximale gestreckte Baulänge der Abgasführung bei Einsatz von flexiblem Rohr in m	im Gebäude senkrecht im Schacht	16 = maximale gestreckte Länge der Abgasführung. Zulufansaugung nach max. 2 m

Dimensionierung

Alle aufgeführten Baulängen beziehen sich auf die gestreckte Länge der Abgasführung, welche nach EN 13384 ermittelt wurde. Bei Einsatz von flexiblen Rohren gelten die Werte in Klammern (). Die Temperaturbedingungen wurde nicht berücksichtigt.

Technische Änderungen der Kesselhersteller vorbehalten. Die Planungs- und Ausführungshinweise für die Heizgeräte sind zu beachten.

 ATAG	Anschlussstück Kesselhersteller	ATEC Anschlussadapter gerade	Verbindungs- leitung	Steigleitung einwandig	Außenwandmontage	
raumluftabhängig						
i24SZ	-	-	80	80-30(30)	80/125-30	
i28CZ / ECZ	-	-	80	80-30(30)	80/125-30	
i35SZ	-	-	80	80-30(30)	80/125-30	
i36ECZ	-	-	80	80-30(30)	80/125-30	
Q15SR	-	-	80	80-30(30)	80/125-30	
Q25SR / Q25 CR Kombi	-	-	80	80-29(26)	80/125-29	
Q38 SR / CR	-	-	80	80-24(21)	80/125-24 100/150-30	
Q50SR	-	-	80	80-13(11)	80/125-13 100/150-30	
Q60SR	RX102020	1146 €43	100	100-30(30)	100/150-30	
XL75 W / F	-	-	100	100-30(30)	100/150-30	
XL105 W / F	-	3151 €59	100	100-28(24)	100/150-26	
XL125 W / F	-	3151 €59	100	100-7(6)	100/150-7 110/160-14	
XL150 W / F	-	3151 €59	100	100-7(6)	125-30(30)	100/150-6 125/190-30
XL180 W / F	-	4106 €124	125	125-25(23)	125/190-25	
XL210 W / F	-	4106 €124	125	125-21(20)	125/190-21	

 ATAG	Anschlussstück Kesselhersteller	ATEC Anschlussadapter gerade	Verbindungs- leitung	Steigleitung einwandig	konzentrisch	Außenwandmontage
raumluftunabhängig						
i24SZ	-	-	80/125	80-30(30)	80/125-28	80/125-30
i28CZ / ECZ	-	-	80/125	80-30(30)	80/125-30	80/125-30
i35SZ	-	-	80/125	80-30(30)	80/125-30	80/125-30
i36ECZ	-	-	80/125	80-29(26)	100-30(30)	80/125-30
Q15SR	-	-	80/125	80-30(30)	80/125-30	80/125-30
Q25SR / Q25 CR Kombi	-	-	80/125	80-18(16)	80/125-14	80/125-30
Q38 SR / CR	-	-	80/125	80-11(10)	100-30(29)	80/125-8 80/125-23
Q50SR	-	-	80/125	80-6(6)	100-19(18)	80/125-4 100/150-30
Q60SR	RX103020	2266 €97	100/150	100-16(15)	100/150-13	100/150-30
XL75 W / F	-	-	100/150	100-20(18))	100/150-12	100/150-30
XL105 W / F	-	-	100/150	100-14(13)	110-24/22	100/150-8 100/150-23
XL125 W / F	-	3151 €59	100/150	100-4(4)	125-9(9)	110/160-5
XL150 W / F, XL180 W / F und XL210 W / F	-	-	auf Anfrage	-	-	-

 BOSCH (JUNKERS)	Anschlussstück Kesselhersteller	ATEC Anschlussadapter gerade	Verbindungs- leitung	Steigleitung einwandig	Außenwandmontage	
raumluftabhängig						
GC 5300iW 14P / i WM 17/100 S 21/23	-	-	80	80-30(30)	80/125-30	
GC 5300iW 14P / 20/24 - 20/30 C/CR / i WM / iWMA 24/100 - 24/210 S 21/23-	-	-	80	80-30(30)	80/125-30	
GC 5700i WT 24/42 S23	-	-	80	80-30(30)	80/125-30	
GC 5800iW 14 P / 24 P	-	-	80	80-30(30)	80/125-30	
GC 7000F 15	-	-	80	80-30(30)	80/125-30	
GC 7000F 22	-	-	80	80-30(30)	80/125-30	
GC 7000F 30	-	-	80	80-30(30)	80/125-30	
GC 7000F 40	-	-	80	80-30(30)	80/125-30	
GC 7000F 50	-	-	80	80-24(21)	100-30(30)	80/125-24 100/150-30
GC 7000F 75 (r) / (l)	-	2232 €51	100	100-30(30)	100/150-30	
GC 7000F 100 (r) / (l)	-	2232 €51	100	100-19(16)	100/150-19	
GC 7000F 150 (r) / (l)	-	6115 €75	160	160-30(30)	160/230-30	
GC 7000F 200 (r) / (l)	-	8115 €77	200	200-30	200/265-30 160/230-30	
GC 7000F 250 (r) / (l)	-	8115 €77	200	200-30	200/265-30 160/230-30	
GC 7000F 300 (r) / (l)	-	8115 €77	200	200-30	200/265-30	
GC 7000iW 14 / 14.1	-	0130 €32	60	60-30(30)	60/100-30	
GC 7000iW 24 / 24 B / 24 BC / 24 C	-	-	80	80-30(30)	80/125-30	
GC 7000iW 28 C / 28 BC	-	-	80	80-30(30)	80/125-30	
GC 7000iW 35 C / 35 BC	-	-	80	80-30(30)	80/125-30	
GC 7000iW 42 / 42B	-	-	80	80-30(30)	80/125-30	
GC 7000WP 70 23	-	2232 €51	100	100-30(30)	100/150-30	
GC 7000WP 100 23	-	2232 €51	100	100-27(24)	100/150-27	
GC 7800iW 15 / 20/24	-	-	80	80-30(30)	80/125-30	
GC 7800iW 25 / 20/30	-	-	80	80-30(30)	80/125-30	
GC 7800iW 30/35	-	-	80	80-30(29)	80/125-29	
GC 7800iW 40	-	-	80	80-30(26)	80/125-26	
GC 8000i F 15	-	-	80	80-30(30)	80/125-30	
GC 8000i F 22	-	-	80	80-30(30)	80/125-30	
GC 8000i F 30	-	-	80	80-30(30)	80/125-30	
GC 8000i F 40	-	-	80	80-30(30)	80/125-30	
GC 8000i F 50	-	-	80	80-23(20)	100-30(30)	80/125-23 100/150-30
GC 9000iWM 20/100 - 20/210 S / SB 23	-	-	80	80-30(30)	80/125-30	
GC 9000iWM 30/100 - 30/210 S / B / SB	-	-	80	80-20(30)	80/125-30	
GC 9800iW 20 P/20 H / 30 P/30 H / 40 H	-	-	80	80-30(30)	80/125-30	
GC 9800iW 50 H	-	-	80	80-30(30)	80/125-30	
ZSB 14-5.2 C	-	-	60	60-30(30)	60/100-30	
ZSB 24-5 C	-	-	80	80-30(30)	80/125-30	
ZWB 24-5 C	-	-	80	80-30(30)	80/125-30	
ZWB 28-5 C	-	-	80	80-30(30)	80/125-30	
OC 7000F 18	-	1115 €33	80	80-30(30)	80/125-30	
OC 7000F 22	-	1115 €33	80	80-30(28)	100-30(30)	80/125-30
OC 7000F 30	-	1115 €33	80	80-15(13)	100-30(30)	80/125-15 100/150-30
OC 7000F 35	-	1115 €33	80	80-17(15)	100-30(30)	80/125-17 100/150-30
OC 7000F 49	-	1166 €55	100	100-30(30)	-	100/150-30
OC 8000iF 19 - 19/120	-	1115 €33	80	80-30(30)	-	80/125-30
OC 8000iF 27 - 25/120	-	1115 €33	80	80-30(30)	-	80/125-30



BOSCH (JUNKERS)	Anschlussstück Kesselhersteller	ATEC Anschlussadapter gerade	Verbindungs- leitung	Steigleitung einwandig	konzentrisch	Außenwandmontage
raumluftunabhängig						
GC 5300iW 14P / i WM 17/100 S 21/23	-	-	80/125	80-30(30)	80/125-30	80/125-30
GC 5300iW 14P / 20/24 - 20/30 C/CR / i WM / iWMA 24/100 - 24/210 S 21/23	-	-	80/125	80-30(30)	80/125-30	80/125-30
GC 5700i WT 24/42 S23	-	-	80/125	80-30(30)	80/125-22	80/125-30
GC 5800iW 14 P / 24 P	-	-	80/125	80-30(30)	80/125-30	80/125-30
GC 7000F 15	-	-	80/125	80-30(30)	80/125-30	80/125-30
GC 7000F 22	-	-	80/125	80-30(23)	80/125-25	80/125-30
GC 7000F 30	-	-	80/125	80-27(25)	100-30(30) 80/125-19	80/125-30
GC 7000F 40	-	-	80/125	80-20(19)	100-30(30) 80/125-14	80/125-30
GC 7000F 50	-	-	80/125	80-13(12)	100-30(30) 80/125-9	80/125-22
GC 7000F 75 (r) / (l)	-	2221 €123	2220 €100	100/150	100-14(14)	100/150-11 100/150-30
GC 7000F 100 (r) / (l)	-	2221 €123	2220 €100	100/150	100-7(6)	100/150-5 100-150-17 100/150-30
GC 7000F 150 (r) / (l) bis 300 (r) / (l)	-	-	-	Auf Anfrage	-	-
GC 7000iW 14 / 14.1	-	-	60/100	60-29(27)	60/100-22	60/100-30
GC 7000iW 24 / 24 B / 24 BC / 24 C	-	-	80/125	80-30(30)	80/125-30	80/125-30
GC 7000iW 28 C / 28 BC	-	-	80/125	80-30(30)	80/125-30	80/125-30
GC 7000iW 35 C / 35 BC	-	-	80/125	80-19(18)	100-30(30) 80/125-14	80/125-30
GC 7000iW 42 / 42B	-	-	80/125	80-20(18)	100-30(30) 80/125-14	80/125-30
GC 7000WP 70 23	-	2221 €123	-	100/150	100-22(20)	100/150-12 100/150-30
GC 7000WP 100 23	-	2221 €123	-	100/150	100-13(12)	100/150-7 100/150-21
GC 7800iW 15 / 20/24	-	-	80/125	80-30(30)	80/125-30	80/125-30
GC 7800iW 25 / 20/30	-	-	80/125	80-30(30)	80/125-27	80/125-30
GC 7800iW 30/35	-	-	80/125	80-24(21)	80/125-15	80/125-30
GC 7800iW 40	-	-	80/125	80-21(18)	100-30(30) 80/125-13	80/125-27
GC 8000i F 15	-	-	80/125	80-30(30)	80/125-30	80/125-30
GC 8000i F 22	-	-	80/125	80-30(30)	80/125-29	80/125-30
GC 8000i F 30	-	-	80/125	80-26(24)	80/125-18	80/125-30
GC 8000i F 40	-	-	80/125	80-20(18)	80/125-14	80/125-30
GC 8000i F 50	-	-	80/125	80-13(12)	100-30(30) 80/125-9	80/125-22 100/150-30
GC 9000iWM 20/100 - 20/210 S / SB 23	-	-	80/125	80-20(30)	80/125-15	80/125-30
GC 9000iWM 30/100 - 30/210 S / B / SB	-	-	80/125	80-30(30)	80/125-15	80/125-30
GC 9800iW 20 P/20 H / 30 P/30 H / 40 H	-	-	80/125	80-30(30)	80/125-30	80/125-30
GC 9800iW 50 H	-	-	80/125	80-30(30)	80/125-26	80/125-30
ZSB 14-5.2 C	-	-	60/100	60-30(30)	60/100-25	60/100-30
ZSB 24-5 C	-	-	80/125	80-30(30)	80/125-26	80/125-30
ZWB 24-5 C	-	-	80/125	80-30(30)	80/125-30	80/125-30
ZWB 28-5 C	-	-	80/125	80-30(30)	80/125-29	80/125-30
OC 7000F 18	-	-	80/125	80-25(24)	80/125-18	80/125-30
OC 7000F 22	-	-	80/125	80-14(13)	100-30(30) 80/125-9	80/125-30
OC 7000F 30	-	-	80/125	100-17(16)	80/125-4	80/125-15 100/150-30
OC 7000F 35	-	-	80/125	100-21(20)	80/125-5	80/125-16 100/150-30
OC 7000F 49	-	-	110/160	110-27(26)	110/160-14	110/160-30
OC 8000iF 19 - 19/120	-	-	80/125	80-20(19)	80/125-14	80/125-30
OC 8000iF 27 - 25/120	-	-	80/125	80-30(30)	80/125-30	80/125-30



BRÖTJE	Anschlussstück Kesselhersteller	ATEC Anschlussadapter gerade	Verbindungs- leitung	Steigleitung einwandig	Außenwandmontage
raumluftabhängig					
BBS EVO 15 i SSP/RSP	-	0130 €32	60	60-22(20) 80-30(30)	60/100-22 80/125-30
BBS EVO 20 i SSP/RSP	-	0130 €32	80	60-15(14) 80-30(30)	80/125-30 60/100-15
BBS EVO 28 i SSP/RSP	-	-	80	80-30(30)	80/125-30
BBK EVO 20/22 i	-	-	80	80-30(30)	80/125-30
BGB EVO 15 i	-	0130 €32	60	60-22(20)	60/100-22
BGB EVO 20 i	-	-	80	80-30(30)	80/125-30
BGB EVO 28 i	-	-	80	80-30(30)	80/125-30
BGB EVO 38 i	-	-	80	80-30(30)	80/125-30
BGB 50 i	-	-	110	100-30(30)	100/150-30
BGB 70 i	-	-	110	110-30(30)	110/160-30
BGB 90 i	-	-	110	110-30(29)	110/160-30
BGB 110 i	-	-	110	110-23(21)	110/160-23 125/190-30
BMK 20/24 B / BMR 20/24 B	-	-	60	80-30(30)	80/125-30
SGB 125 i	-	6115 €75	160	125-24(24)	125/190-24
SGB 170 i	-	6115 €75	160	160-30(30)	160/230-30
SGB 215 i	-	8115 €77	6103 €155	160-30(30)	160/230-30
SGB 260 i	-	8115 €77	6103 €155	160-18(18)	160/230-18 200/265-30
SGB 300 i	-	8115 €77	200	200-30	200/265-30
SGB 400 i	-	8102 €155	8115 €77	200-30	200/265-30
SGB 470 i	-	8102 €155	8115 €77	200-23	200/265-23
SGB 540 i	-	8102 €155	8115 €77	200-11	200/265-11 250/315-30
SGB 610 i	-	9115 €110	250	250-30	250/315-30
WBC 22/28.1	-	-	60	80-30(30)	80/125-30
WBS 14.1	-	-	60	60-27(22)	60/100-22 80/125-30
WBS 22.1	-	-	60	60-12(9) 80-30(30)	60/100-12 80/125-30
WGB 14.1	-	-	60	60-27(22)	60/100-27 80/125-30
WGB 22.1	-	-	60	60-12(10) 80-30(30)	60/100-12 80/125-30
WGB 28.1 / WGB-K 22/28.1	-	1137 €35	80	80-30(30)	80/125-30
WGB 38.1	-	1137 €35	80	80-30(28)	80/125-30
WGB 50 i	-	-	110	110-30(30)	110/160-30
WGB 70 i	-	-	110	110-30(30)	110/160-30
WGB 90 i	-	-	110	110-30(29)	110/160-30
WGB 110 i	-	-	110	110-23(21)	110/160-23 125/190-30
WLS 24	-	1137 €35	80	80-30(30)	80/125-30
WMS 12 C	-	-	60	60-30(30)	60/100-30
WMS 24 C	-	1137 €35	80	80-30(30)	80/125-30
WMC 20/33 C	-	1137 €35	80	80-30(28)	80/125-30
BOB 20 B	-	-	80	80-30(30)	80/125-30

Fortsetzung Brötje raumluftabhängig

BOB 32/40 B	-	2232 €51	-	100	100-30(30)	-	-	100/150-30	-
BOB 25 B	-	-	-	80	80-30(30)	-	-	80/125-30	-
BOK 19	-	1115 €33	-	80	80-28(25)	-	-	80/125-28	-
BOK 24	-	1115 €33	-	80	80-25(23)	-	-	80/125-25	-



BRÖTJE	Anschlussstück Kesselhersteller	ATEC Anschlussadapter gerade	Verbindungs- leitung	Steigleitung einwandig	konzentrisch	Außenwandmontage
raumluftunabhängig						
BBS EVO 15 i SSP/RSP	-	-	60/100	60-19(17)	80-30(30)	60/100-13 60/100-22 80/125-30
BBS EVO 20 i SSP/RSP	-	-	80/125	80-30(30)	-	80/125-30 80/125-30 -
BBS EVO 28 i SSP/RSP	-	-	80/125	80-29(26)	-	80/125-20 80/125-30 -
BBK EVO 20/22 i	-	-	80/125	80-30(30)	-	80/125-30 80/125-30 -
BGB EVO 15 i	-	-	60/100	60-18(17)	-	60/100-13 60/100-22 -
BGB EVO 20 i	-	-	80/125	80-30(30)	-	80/125-30 80/125-30 -
BGB EVO 28 i	-	-	80/125	80-30(30)	-	80/125-22 80/125-30 -
BGB EVO 38 i	-	-	80/125	80-21(19)	100-30(30)	80/125-14 80/125-30 -
BGB 50 i	-	-	110/160	100-24(22)	-	100/150-19 100/150-30 -
BGB 70 i	-	-	110/160	110-19(18)	125-30(26)	110/160-9 110/160-30 -
BGB 90 i	-	-	110/160	110-13(12)	125-23(22)	110/160-6 110/160-28 -
BGB 110 i	-	-	110/160	125-15(15)	160-30(30)	125/190-15 110/160-19 125/190-30
BMK 20/24 B / BMR 20/24 B	-	-	60/100	80-30(28)	-	80/125-20 80/125-30 -
SGB 125 i	-	-	auf Anfrage	-	-	- - -
SGB 170 i	-	-	auf Anfrage	-	-	- - -
SGB 215 i	-	-	auf Anfrage	-	-	- - -
SGB 260 i	-	-	auf Anfrage	-	-	- - -
SGB 300 i	-	-	auf Anfrage	-	-	- - -
SGB 400 i	-	-	auf Anfrage	-	-	- - -
SGB 470 i	-	-	auf Anfrage	-	-	- - -
SGB 540 i	-	-	auf Anfrage	-	-	- - -
SGB 610 i	-	-	auf Anfrage	-	-	- - -
WBC 22/28.1	80/125 von Brötje	-	60/100	80-30(30)	-	80/125-17 80/125-30 -
WBS 14.1	80/125 von Brötje	-	60/100	60-15(15)	-	60/100-13 60/100-15 -
WBS 22.1	80/125 von Brötje	-	60/100	60-9(7)	80-30(30)	80/125-26 60/100-6 80/125-26
WGB 14.1	80/125 von Brötje	-	60/100	60-15(14)	80-18(18)	60/100-14 60/100-15 80/125-18
WGB 22.1	80/125 von Brötje	-	60/100	60-9(8)	80-18(17)	60/100-6 60/100-10 80/125-30
WGB 28.1 / WGB-K 22/28.1	80/125 von Brötje	1266 €62	80/125	80-19(18)	-	80/125-18 80/125-30 -
WGB 38.1	80/125 von Brötje	1266 €62	80/125	80-19(19)	100-21(20)	80/125-15 80/125-30 -
WGB 50 i	-	-	110/160	110-30(30)	-	110/160-23 110/160-26 -
WGB 70 i	-	-	110/160	110-19(18)	125-30(30)	110/160-9 110/160-30 -
WGB 90 i	-	-	110/160	110-13(12)	125-23(22)	110/160-6 110/160-28 -
WGB 110 i	-	-	110/160	125-15(15)	160-30(30)	125/190-15 110/160-19 125/190-30
WLS 24	-	-	80/125	80-30(30)	-	80/125-30 80/125-30 -
WMS 12 C	-	-	60/100	60-30(30)	-	60/100-28 60/100-30 -
WMS 24 C	-	-	80/125	80-30(30)	-	80/125-30 80/125-30 -
WMC 20/33 C	-	-	80/125	80-20(18)	-	80/125-14 80/125-30 -
BOB 20 B	-	-	80/125	80-30(30)	-	80/125-26 80/125-30 -
BOB 32/40 B	-	-	110/160	110-30(30)	-	110/160-30 110/160-30 -
BOB 25 B	-	-	80/125	80-28(25)	-	80/125-19 80/125-30 -



BRUNS	Anschlussstück Kesselhersteller	ATEC Anschlussadapter gerade	Verbindungs- leitung	Steigleitung einwandig	Außenwandmontage
raumluftabhängig					
TREND-BW 8-14	8166029	-	80	80-20(20)	- 80/125-20 -
TREND-BW 15-23	8166029	-	80	80-25(25)	- 80/125-24 -
TREND-BW 20-30	8166029	-	80	80-30(24)	- 80/125-30 -
Trend BWA I, BWA II und BWA WZ II	8166029	-	80	80-30(30)	- 80/125-30 -



BRUNS	Anschlussstück Kesselhersteller	ATEC Anschlussadapter gerade	Verbindungs- leitung	Steigleitung einwandig	konzentrisch	Außenwandmontage
raumluftunabhängig						
TREND-BW 8-14	8166029	-	80/125	80-20(20)	-	80/125-20 80/125-20 -
TREND-BW 15-23	8166029	-	80/125	80-20(20)	-	80/125-20 80/125-20 -
TREND-BW 20-30	8166029	-	80/125	80-20(18)	-	80/125-18 80/125-20 -
Trend BWA I, BWA II und BWA WZ II	8166029	-	80/125	80-30(30)	-	80/125-30 80/125-30 -



BUDERUS	Anschlussstück Kesselhersteller	ATEC Anschlussadapter gerade	Verbindungs- leitung	Steigleitung einwandig	Außenwandmontage	
raumluftabhängig						
GB 162-50 V2 Logamax Plus	-	-	110	100-30(30)	- 100/150-30 -	
GB 162-70 V2 Logamax Plus	-	-	110	110-30(30)	- 110/160-30 -	
GB 162-85 V2 Logamax Plus	-	-	110	110-30(30)	- 110/160-30 -	
GB 162-100 V2 Logamax Plus	-	-	110	110-30(30)	- 110/160-30 -	
GB 172-14 / GB 172i-17 T100S Logamax Plus	-	-	80	80-30(30)	- 80/125-30 -	
GB 172-20 / GB 172i-24 T100S Logamax Plus	-	-	80	80-30(30)	- 80/125-30 -	
GB 172-24 / 172-24K Logamax Plus	-	-	80	80-20(20)	- 80/125-20 -	
GB 172i.2-15 W / 172i.2-20 W H / 172i.2-20 KDW H / 172i.2-25 W H	-	-	80	80-30(30)	- 80/125-30 -	
GB 182i-20KB (WWW) Logamax Plus	-	-	80	80-30(21)	- 80/125-30 -	
GB 182i-24 Logamax Plus	-	-	80	80-30(30)	- 80/125-30 -	
GB 182i-35K Logamax Plus	-	-	80	80-27(18)	- 80/125-25 -	
GB 182i.2-15 W H / 182i.2-20 W H / 182i.2-25 W H	-	-	80	80-30(30)	- 80/125-30 -	
GB 182i.2-35 W H Logamax Plus	-	-	80	80-30(30)	- 80/125-30 -	
GB 182i.2-45 W H Logamax Plus	-	-	80	80-30(27)	- 80/125-30 -	
GB 192-30 iT40S	-	-	80	80-28(18)	100-30(30)	80/125-27 80/125-30 -
GB 192iT-15 / GB 192iT-25 Logamax Plus	-	-	80	80-30(30)	- 80/125-30 -	
GB 192i-19 Logamax Plus	-	-	80	80-30(30)	- 80/125-30 -	
GB(H)192i.2-15 / 192i.2-25 Logamax Plus	-	-	80	80-30(30)	- 80/125-30 -	
GB(H) 192i.2-35 / GB 192i.2-30 T140S Logamax Plus	-	-	80	80-30(30)	- 80/125-30 -	

Fortsetzung Buderus raumluftabhängig

GB 192i.2-50 Logamax Plus	-	-	-	80	80-30(27)	-	80/125-30	-
GB(H) 212-15/5 / 22/6 Logano Plus	-	-	-	80	80-25(25)	-	80/125-25	-
GB(H) 212-30/9 Logano Plus	-	-	-	80	80-25(25)	-	80/125-25	-
GB 212-50 Logano Plus	-	-	-	80	80-20(15)	-	80/125-20	-
GB 272-50 H Logamax Plus	-	-	-	110	110-30(30)	-	110/160-30	-
GB 272-70 H Logamax Plus	-	-	-	110	110-30(30)	-	110/160-30	-
GB 272-85 H Logamax Plus	-	-	-	110	110-30(30)	-	110/160-30	-
GB 272-100 H Logamax Plus	-	-	-	110	110-30(30)	-	110/160-30	-
GB 272-125 H Logamax Plus	-	-	-	110	110-27(25)	-	110/160-27	-
GB 272-150 H Logamax Plus	-	-	-	110	110-24(22)	-	110/160-24	-
KB(H) 192i-15 / 192iT-15 Logano Plus	-	-	-	80	80-30(30)	-	80/125-30	-
KB(H) 192i-22 / 192iT-22 Logano Plus	-	-	-	80	80-30(30)	-	80/125-30	-
KB(H) 192i-30 / 192iT-30 Logano Plus	-	-	-	80	80-30(26)	-	80/125-30	-
KB(H) 192i-40 Logano Plus	-	-	-	80	80-30(30)	-	80/125-30	-
KB 192i-50 Logano Plus	-	-	-	80	80-20(14)	100-30(30)	80/125-20	100/150-30
KB 195i-15 / 195iT-15 / 195i-19 / 195iT-19 Logano Plus	-	-	-	80	80-30(30)	-	80/125-30	-
KB 195i-25 / 195iT-25 Logano Plus	-	-	-	80	80-30(30)	-	80/125-30	-
KB 372-75 Logano Plus	-	-	-	110	110-30(30)	-	110/160-30	-
KB 372-100 Logano Plus	-	-	-	110	110-26(19)	-	110/160-24	-
KB 372-150 Logano Plus	-	4104 €118	-	125	125-23(15)	-	125/190-23	-
KB 372-200 / 250 / 300 Logano Plus	-	-	-	200	200-30	-	200/265-30	-
GB 125-18 Logano Plus	7747016312	-	-	80	80-20(18)	-	80/125-20	-
GB 125-22 Logano Plus	7747016312	-	-	80	80-20(14)	-	80/125-20	-
GB 125-30 Logano Plus	7747016312	-	-	80	80-12(8)	100-20(20)	80/125-11	-
GB 125-35 Logano Plus	7747016312	-	-	80	80-18(16)	100-30(30)	80/125-18	-
GB 125-49 Logano Plus	7747016312	-	-	80	80-8(7)	100-30(30)	80/125-8	100/150-30
GB 125-60 Logano Plus	7747016312	-	-	80	100-9(7)	110-21(16)	100/150-9	110/160-21
SB 325-50 / SB 325-70 Logano Plus	87090602	4115 €60	-	125	125-30(30)	-	125/190-30	-
SB 325-90 Logano Plus	87090634	6115 €75	-	160	125-30(20)	-	125/190-30	-
SB 325-115 Logano Plus	87090634	6115 €75	-	160	160-30(30)	-	160/230-30	-





BUDERUS	Anschlussstück	ATEC Anschlussadapter	Verbindungs-	Steigleitung	konzentrisch	Außenwandmontage
raumluftunabhängig	Kesselhersteller	gerade	leitung	einwandig		
GB 162-50 V2 Logamax Plus	-	-	110/160	100-24(22)	100/150-18	100/150-30
GB 162-70 V2 Logamax Plus	-	-	110/160	110-30(30)	110/160-19	110/160-30
GB 162-85 V2 Logamax Plus	-	-	110/160	110-30(30)	110/160-17	110/160-30
GB 162-100 V2 Logamax Plus	-	-	110/160	110-24(23)	110/160-13	110/160-30
GB 172-14 / GB 172i-17 T100S Logamax Plus-	-	-	80/125	80-30(30)	80/125-30	80/125-30
GB 172-20 / GB 172i-24 T100S Logamax Plus-	-	-	80/125	80-30(30)	80/125-30	80/125-30
GB 172-24 / 172-24K Logamax Plus	-	-	80/125	80-17(13)	80/125-13	80/125-20
GB 172i.2-15 W / 172i.2-20 W H / 172i.2-20 KDW H / 172i.2-25 W H	-	-	80/125	80-30(30)	80/125-30	80/125-30
GB 182i-20KB (WW) Logamax Plus	-	-	80/125	80-17(13)	80/125-15	80/125-20
GB 182i-24 Logamax Plus	-	-	80/125	80-17(14)	80/125-21	80/125-30
GB 182i-35K Logamax Plus	-	-	80/125	80-15(11)	100-30(30)	100/150-30
GB 182i.2-15 W H / 182i.2-20 W H / 182i.2-25 W H	-	-	80/125	80-30(30)	80/125-30	80/125-30
GB 182i.2-35 W H Logamax Plus	-	-	80/125	80-30(30)	80/125-30	80/125-30
GB 182i.2-45 W H Logamax Plus	-	-	80/125	80-28(25)	80/125-26	80/125-30
GB 192-30 iT40S	-	-	80/125	80-18(14)	100-24(21)	80/125-14
GB 192iT-15 / GB 192iT-25 Logamax Plus	-	-	80/125	80-30(30)	80/125-15	80/125-30
GB 192i-19 Logamax Plus	-	-	80/125	80-30(30)	80/125-30	80/125-30
GB(H)192i.2-15 / 192i.2-25 Logamax Plus	-	-	80/125	80-30(30)	80/125-30	80/125-30
GB(H) 192i.2-35 / GB 192i.2-30 T140S Logamax Plus	-	-	80/125	80-30(27)	80/125-20	80/125-30
GB 192i.2-50 Logamax Plus	-	-	80/125	80-23(19)	80/125-14	80/125-29
GB(H) 212-15/5 / 22/6 Logano Plus	-	-	80/125	80-25(22)	80/125-22	80/125-25
GB(H) 212-30/9 Logano Plus	-	-	80/125	80-20(15)	80/125-17	80/125-25
GB 212-40/10 Logano Plus	-	-	80/125	80-15(11)	100-25(25)	80/125-25
GB 212-50 Logano Plus	-	-	80/125	100-25(25)	-	80/125-14
GB 272-50 H Logamax Plus	-	-	110/160	110-30(30)	110/160-27	110/160-30
GB 272-70 H Logamax Plus	-	-	110/160	110-30(30)	110/160-23	110/160-30
GB 272-85 H Logamax Plus	-	-	110/160	110-28(27)	110/160-14	110/160-30
GB 272-100 H Logamax Plus	-	-	110/160	110-26(25)	-	110/160-30
GB 272-125 H Logamax Plus	-	-	110/160	110-11(10)	125-21(20)	110/160-17
GB 272-150 H Logamax Plus	-	-	110/160	110-9(8)	125-18(17)	110/160-14
KB(H) 192i-15 / 192iT-15 Logano Plus	-	-	80/125	80-30(30)	-	80/125-30
KB(H) 192i-22 / 192iT-22 Logano Plus	-	-	80/125	80-30(30)	-	80/125-28
KB(H) 192i-30 / 192iT-30 Logano Plus	-	-	80/125	80/25(18)	-	80/125-19
KB(H) 192i-40 Logano Plus	-	-	80/125	80-25(21)	-	80/125-15
KB 192i-50 Logano Plus	-	-	80/125	80-14(10)	100-30(29)	80/125-10
KB 195i-15 / 195iT-15 / 195i-19 / 195iT-19 Logano Plus	-	-	80/125	80-30(30)	-	80/125-30
KB 195i-25 / 195iT-25 Logano Plus	-	-	80/125	80-30(30)	-	80/125-18
KB 372-75 Logano Plus	-	-	110/160	110-26(20)	-	110/160-17
KB 372-100 Logano Plus	-	-	110/160	110-11(8)	125-30(30)	110/160-7
KB 372-150 Logano Plus	-	-	160/230	125/190-23	-	160/230-30
GB 125-18 Logano Plus	7747016312	-	80/125	80-16(13)	-	80/125-14
GB 125-22 Logano Plus	7747016312	-	80/125	80-12(9)	-	80/125-10
GB 125-30 Logano Plus	7747016312	-	80/125	100-14(12)	80-14(10)	100/150-12
GB 125-35 Logano Plus	7747016312	-	80/125	80-8(8)	100-30(29)	100/150-18
GB 125-49 Logano Plus	7747016312	-	80/125	80-4(3)	100-17(16)	100/150-10
GB 125-60 Logano Plus	7747016312	-	110/160	110-11(9)	-	110/160-5





CTC	Anschlussstück	ATEC Anschlussadapter	Verbindungs-	Steigleitung	Außenwandmontage
raumluftabhängig	Kesselhersteller	gerade	leitung	einwandig	
GBK	-	-	80	80-25(25)	80/125-23
380 IC 17 bis 29 kW	-	-	80	80-25(25)	80/125-25
380 IC 35 kW	-	-	80	80-25(25)	80/125-25
380 IC 43 kW	-	-	80	80-24(16)	80/125-25

 CTC	Anschlussstück Kesselhersteller	ATEC Anschlussadapter gerade	Verbindungs- leitung	Steigleitung einwandig	konzentrisch	Außenwandmontage
raumluftunabhängig						
GBK	21440030GBK	-	80/125	80-13(13)	-	80/125-13 80/125-21 -
380 IC 17 bis 29 kW	21440017U	-	80/125	80-25(25)	-	80/125-25 80/125-25 -
380 IC 35 kW	21440017U	-	80/125	80-25(19)	-	80/125-18 80/125-25 -
380 IC 43 kW	21440017U	-	80/125	80-16(12)	-	80/125-11 80/125-21 -

 DAIKIN / ROTEX	Anschlussstück Kesselhersteller	ATEC Anschlussadapter gerade	Verbindungs- leitung	Steigleitung einwandig	Außenwandmontage	
raumluftabhängig						
C Gas ECH2 O 315/515	-	0115 €35	60	60-30(30)	-	60/100-30 -
C Gas ECH2 O 320/520	-	0115 €35	60	60-30(23)	-	60/100-30 -
C Gas ECH2 O 524	-	1137 €35	80	80-30(30)	-	80/125-30 -
C Gas ECH2 O 528	-	1137 €35	80	80-30(30)	-	80/125-30 -
C Gas W Top / 3C Gas W 12T - Altherma	-	-	60	60-30(30)	-	60/100-30 -
C Gas W Top / 3C Gas W 18T - Altherma	-	1137 €35	80	80-30(30)	-	80/125-30 -
C Gas W Top / 3C Gas W 22C - Altherma	-	1137 €35	80	80-30(30)	-	80/125-30 -
C Gas W Top / 3C Gas W 28C - Altherma	-	1137 €35	80	80-30(30)	-	80/125-30 -
C Gas W Top / 3C Gas W 33C - Altherma	-	1137 €35	80	80-20(18)	-	80/125-20 -
C Oil A2F 18H	-	1115 €33	80	80-30(30)	-	80/125-30 -
C Oil A2F 24H	-	1115 €33	80	80-30(30)	-	80/125-30 -
C Oil A2F 32H	-	1115 €33	80	80-30(30)	-	80/125-30 -

 DAIKIN / ROTEX	Anschlussstück Kesselhersteller	ATEC Anschlussadapter gerade	Verbindungs- leitung	Steigleitung einwandig	konzentrisch	Außenwandmontage
raumluftunabhängig						
C Gas ECH2 O 315/515	-	-	60/100	60-30(30)	-	60/100-30 60/100-30 -
C Gas ECH2 O 320/520	-	-	80/125	80-30(30)	-	80/125-30 80/125-30 -
C Gas ECH2 O 524	-	-	80/125	80-30(30)	-	80/125-30 80/125-30 -
C Gas ECH2 O 528	-	-	80/125	80-30(30)	-	80/125-30 80/125-30 -
C Gas W Top / 3C Gas W 12T - Altherma	-	-	60/100	60-30(30)	-	60/100-30 60/100-30 -
C Gas W Top / 3C Gas W 18T - Altherma	-	-	80/125	80-30(30)	-	80/125-30 80/125-30 -
C Gas W Top / 3C Gas W 22C - Altherma	-	-	80/125	80-16(12)	-	80/125-14 80/125-20 -
C Gas W Top / 3C Gas W 28C - Altherma	-	-	80/125	80-14(11)	-	80/125-11 80/125-18 -
C Gas W Top / 3C Gas W 33C - Altherma	-	-	80/125	80-11(8)	100-25(20)	80/125-9 80/125-20 -
C Oil A2F 18H	-	-	80/125	80-30(30)	-	80-30(30) 80/125-30 -
C Oil A2F 24H	-	-	80/125	80-30(30)	-	80-30(30) 80/125-30 -
C Oil A2F 32H	-	-	80/125	80-30(28)	-	80-20(29) 80/125-30 -

 E.C.A	Anschlussstück Kesselhersteller	ATEC Anschlussadapter gerade	Verbindungs- leitung	Steigleitung einwandig	Außenwandmontage	
raumluftabhängig						
Confeo Premix 14	-	-	60	60-30(30)	-	60/100-30 -
Confeo Premix 20 / Premix 24	-	-	80	80-30(30)	-	80/125-30 -
Confeo Premix 28 / Premix 30	-	-	80	80-30(30)	-	80/125-30 -
Confeo Premix 35	-	-	80	80-30(30)	-	80/125-30 -

 E.C.A	Anschlussstück Kesselhersteller	ATEC Anschlussadapter gerade	Verbindungs- leitung	Steigleitung einwandig	konzentrisch	Außenwandmontage
raumluftunabhängig						
Confeo Premix 14	-	-	60/100	60-30(30)	-	60/100-30 60/100-30 -
Confeo Premix 20 / Premix 24	-	-	80/125	80-30(30)	-	80/125-28 80/125-30 -
Confeo Premix 28 / Premix 30	-	-	80/125	80-30(28)	-	80/125-21 80/125-30 -
Confeo Premix 35	-	-	80/125	80-29(27)	-	80/125-20 80/125-29 -

 ELCO	Anschlussstück Kesselhersteller	ATEC Anschlussadapter gerade	Verbindungs- leitung	Steigleitung einwandig	Außenwandmontage	
raumluftabhängig						
THISION MINI 15.3	-	-	60	60-30(30)	-	60/100-30 -
THISION MINI 22.3 / Combi 22.3	-	-	60	60-13(11)	80-30(30)	60/100-12 80/125-30 -
THISION MINI 28.3	-	1137 €35	80	80-30(30)	-	80/125-30 -
THISION S PLUS 13,15,19 / 13,19 Compact V / 13,19 Solar V	-	-	80	80-30(30)	-	80/125-30 -
THISION S PLUS 24 / 24 Compact V / 24 Solar V	-	-	80	80-30(30)	-	80/125-30 -
THISION S PLUS 24 Combi	-	-	80	80-29(25)	-	80/125-29 -
THISION S PLUS 34 / 34 Combi / 30 Compact V / 34 Solar V	-	-	80	80-20(18)	100-30(30)	80/125-20 100/150-30 -
THISION S PLUS 46	-	-	80	80-12(11)	100-30(30)	80/125-12 100/150-30 -
THISION S PLUS 54	-	-	80	100-30(30)	-	100/150-30 -
TRIGON S PLUS 13, 15, 19	-	-	80	80-30(30)	-	80/125-30 -
TRIGON S PLUS 24	-	-	80	80-30(30)	-	80/125-30 -
TRIGON S PLUS 34	-	-	80	80-23(20)	-	80/125-23 -
TRIGON S PLUS 40	-	-	80	80-18(16)	100-30(30)	80/125-18 100/150-30 -
TRIGON L PLUS / THISION L PLUS 60	-	-	100	100-30(30)	-	100/150-30 -
TRIGON L PLUS / THISION L PLUS 70	-	-	100	100-30(30)	-	100/150-30 -
TRIGON L PLUS / THISION L PLUS 100	-	-	100	100-19(16)	-	100/150-19 -
TRIGON L PLUS / THISION L PLUS 120	-	-	100	100-6(5)	125-30(30)	100/150-6 125/190-30 -
TRIGON L PLUS / THISION L PLUS 140	-	3151 €59	100	125-28(26)	-	125/190-28 -
TRIGON L PLUS / THISION L PLUS 170	-	4106 €124	125	125-14(13)	160-30(30)	125/190-14 160/230-30 -
TRIGON L PLUS / THISION L PLUS 200	-	4106 €124	125	125-13(13)	160-30(30)	125/190-13 160/230-30 -
TRIGON XL 150	-	4101 €118+4115 €60-	125	125-30(30)	-	125/190-30 -
TRIGON XL 200	-	4101 €118+4115 €60-	125	125-24(24)	160-30(30)	125/190-24 160/230-30 -
TRIGON XL 250	-	6118 €155+6115 €75-	160	160-30(30)	-	160/230-30 -
TRIGON XL 300	-	6118 €155+6115 €75-	160	160-30(30)	-	160/230-30 -
TRIGON XL 400	-	6118 €155+6115 €75-	160	160-30(30)	-	160/230-30 -

Fortsetzung Elco raumluftabhängig

TRIGON XL 500	-	9101 €187+8115 €77-	200	200-30	-	-	200/265-30	-
TRIGON XL 570	-	9101 €187+8115 €77-	200	200-30	-	-	200/265-30	-
TRIGON XXL EVO 700	-	9107 €308	9115 €110	250	250-30	-	250/315-30	-
TRIGON XXL EVO 800	-	9105 €320	9115 €110	250	250-30	-	250/315-30	-
TRIGON XXL EVO 900	-	-	-	350	350-30	-	DW350-30	-
TRIGON XXL EVO 1000 / 1100	-	-	-	350	350-30	-	DW350-30	-
TRIGON XXL EVO 1200 / 1400	-	-	-	350	350-30	-	DW350-30	-
TRIGON XXL EVO 1550 / 1700	-	-	-	400	400-30	-	DW400-30	-
TRIGON XXL EVO 2000	-	-	-	450	450-30	-	DW450-30	-
STRATON S 17.2	-	1115 €33	-	80	80-30(30)	-	80/125-30	-
STRATON S 21.2	-	1115 €33	-	80	80-30(30)	-	80/125-30	-
STRATON S 26.2	-	1115 €33	-	80	80-30(30)	-	80/125-30	-
STRATON S 30.2	-	1115 €33	-	80	80-30(30)	-	80/125-30	-
STRATON S 35.2	-	1115 €33	-	80	80-26(23)	100-30(30)	80/125-26	100/150-30
STRATON S 40.2	-	1115 €33	-	80	80-18(16)	100-30(30)	80/125-19	100/150-30



ELCO	Anschlussstück Kesselhersteller	ATEC Anschlussadapter gerade	Verbindungs- leitung	Steigleitung einwandig	konzentrisch	Außenwandmontage
raumluftunabhängig						
THISION MINI 15.3	3722818	-	60/100	60-29(26)	60/100-21	60/100-30
THISION MINI 22.3 / Combi 22.3	3722818	-	60/100	60-10(9)	80-30(30)	60/100-7 60/100-12 80/125-30
THISION MINI 28.3	3722818	1222 €62	80/125	80-30(30)	80/125-27	80/125-30
THISION S PLUS 13,15,19 / 13,19 Compact V / 13,19 Solar V	-	-	80/125	80-30(30)	80/125-30	80/125-30
THISION S PLUS 24 / 24 Compact V / 24 Solar V	-	-	80/125	80-30(30)	80/125-30	80/125-30
THISION S PLUS 24 Combi	-	-	80/125	80-17(16)	80/125-11	80/125-28
THISION S PLUS 34 / 34 Combi / 30 Compact V / 34 Solar V	-	-	80/125	80-13(12)	100-30(30)	80/125-9 80/125-19 100/150-30
THISION S PLUS 46	-	-	80/125	100-23(21)	80/125-5	80/125-11 100/150-30
THISION S PLUS 54	-	-	80/125	100-13(12)	100/150-9	100/150-30
TRIGON S PLUS 13, 15, 19	-	-	80/125	80-30(30)	80/125-30	80/125-30
TRIGON S PLUS 24	-	-	80/125	80-30(30)	80/125-30	80/125-30
TRIGON S PLUS 34	-	-	80/125	80-14(12)	100-30(30)	80/125-22
TRIGON S PLUS 40	-	-	80/125	100-30(30)	80/125-7	80/125-17 100/150-30
TRIGON L PLUS / THISION L PLUS 60	-	-	100/150	100-30(27)	100/150-19	100/150-30
TRIGON L PLUS / THISION L PLUS 70	-	-	100/150	100-20(19)	100/150-11	100/150-30
TRIGON L PLUS / THISION L PLUS 100	-	-	100/150	100-8(8)	100/150-5	100/150-17
TRIGON L PLUS / THISION L PLUS 120	-	-	100/150	125-8(8)	125/190-6	100/150-4 125/190-24
TRIGON L PLUS / THISION L PLUS 140 - 200	auf Anfrage	-	-	-	-	-
STRATON S 17.2	21775	-	80/125	80-30(30)	80/125-30	80/125-30
STRATON S 21.2	21775	-	80/125	80-30(30)	80/125-30	80/125-30
STRATON S 26.2	21775	-	80/125	80-30(30)	80/125-24	80/125-30
STRATON S 30.2	21775	-	80/125	80-24(22)	80/125-17	80/125-30
STRATON S 35.2	21775	-	80/125	80-16(15)	100-30(30)	80/125-11 80/125-25 100/150-30
STRATON S 40.2	21775	-	80/125	100-30(30)	100/150-25	100/150-30



GIERSCH CTC	Anschlussstück Kesselhersteller	ATEC Anschlussadapter gerade	Verbindungs- leitung	Steigleitung einwandig	Außenwandmontage
raumluftunabhängig					
GiegeaSwift Plus 24, 24d, 28c	-	1137 €35	80	80-20(20)	80/125-20
GiegeaStar Plus 15	-	0130 €32	60	60-18(12)	60/100-15
GiegeaStar Plus 25 / C28	-	-	80	80-20(20)	80/125-20
GiegeaStar Plus 35	-	-	80	80-25(20)	80/125-20
GiegeaStar Plus 46	-	-	80	80-22(15)	80/125-20
GiegeaStar Plus 66	-	-	100	100-25(17)	100/150-20
GiegeaStar Plus 86	-	-	100	100-20(14)	100/150-20
GiegeaStar 116	-	-	100	100-16(10)	110-30(19) 100/150-16
GiegeaBloc 200-3	-	4101 €118	125	125-30(30)	125/190-30
GiegeaBloc 200-4	-	4101 €118	125	125-25(17)	160-30 125/190-25
GiegeaBloc 200-5	-	6101 €133	160	160-30(30)	160/230-30
GiegeaBloc 200-6	-	6101 €133	160	160-30(30)	160/230-30
FCU17	-	-	80	80-30(23)	80/125-30
FCU25	-	-	80	80-17(12)	80/125-17
FCU30	-	-	80	80-13(10)	80/125-13
GK 50	-	3115 €56	1142 €43	80-25(25)	80/125-20
GK 70	-	3115 €56	2232 €51	100-30(30)	100/150-25
GK 100	-	3115 €56	110	110-23(16)	125/190-25
GK 250	-	6115 €75	160	160-30(28)	160/230-30



GIERSCH CTC	Anschlussstück Kesselhersteller	ATEC Anschlussadapter gerade	Verbindungs- leitung	Steigleitung einwandig	konzentrisch	Außenwandmontage
raumluftunabhängig						
GiegeaSwift Plus 24, 24d, 28c	-	-	80/125	80-18(14)	80/125-14	80/125-20
GiegeaStar Plus 15	-	-	60/100	60-13(9)	60/100-10	60/100-15
GiegeaStar Plus 25 / C28	-	-	80/125	80-20(18)	80/125-15	80/125-20
GiegeaStar Plus 35	-	-	80/125	80-25(20)	80/125-15	80/125-20
GiegeaStar Plus 46	-	-	80/125	80-13(10)	80/125-10	80/125-15
GiegeaStar Plus 66	-	-	100/150	100-9(7)	125-25(22)	100/150-6 100/150-15
GiegeaStar Plus 86	-	-	100/150	125-25(20)	100/150-6	100/150-12
GiegeaBloc 200-3 bis 200-6	-	-	auf Anfrage	-	-	-
FCU17	-	-	80/125	80-19(15)	80/125-15	80/125-30
FCU25	-	-	80/125	100-18(16)	80/125-8	80/125-14
FCU30	-	-	80/125	110-20(17)	-	100/150-20
GK 50	-	-	80/125	100-30(30)	80/125-13	80/125-18
GK 70	-	-	110/160	110-25(25)	110/160-25	110/160-30
GK 100	-	-	110/160	125-17	160-30(30)	125/190-30

	HANSA	Anschlussstück	ATEC Anschlussadapter	Verbindungs-	Steigleitung	Außenwandmontage		
	raumluftabhängig	Kesselhersteller	gerade					leitung
	Integra 36_19 / 36_25 / 36_31	-	-	80	100-26(24)	-	100/150-26	-
	Integra 60_37 / 60_44 / 60_52	-	-	110	110-17(16)	-	110/160-17	-
	PEGA 25_18 / PEGA 25	-	0130 €32	60	60-18(16)	-	60/100-18	-
	PEGA 40	-	-	80	80-30(30)	-	80/125-30	-
	TANTUM 25 / Kombi / Kompakt	-	-	80	80-30(30)	-	80/125-30	-

	HANSA	Anschlussstück	ATEC Anschlussadapter	Verbindungs-	Steigleitung	Außenwandmontage			
	raumluftunabhängig	Kesselhersteller	gerade					leitung	einwandig
	PEGA 25_18 / PEGA 25	-	-	60/100	60-13(10)	-	60/100-10	60/100-16	-
	PEGA 40	-	-	80/125	80-30(30)	-	80/125-23	80/125-30	-
	TANTUM 25 / Kombi / Kompakt	-	-	80/125	80-30(30)	-	80/125-30	80/125-30	-

	HOVAL	Anschlussstück	ATEC Anschlussadapter	Verbindungs-	Steigleitung	Außenwandmontage		
	raumluftabhängig	Kesselhersteller	gerade					leitung
	TopGas comfort RS-OT / TTE 10 / 16 / 22	-	1115 €33	80	80-30(30)	-	80/125-30	-
	TopGas combi RS-OT 21/18	-	1115 €33	80	80-30(30)	-	80/125-30	-
	TopGas combi RS-OT 26/23	-	1115 €33	80	80-30(30)	-	80/125-30	-
	TopGas combi RS-OT 32/28	-	1115 €33	80	80-30(30)	-	80/125-30	-
	TopGas classic 35 / 45	-	2115 €44	100	100-30(30)	-	100/150-30	-
	TopGas classic 80	-	2115 €44	100	100-30(30)	-	100/150-30	-
	UltraGas 15 / UltraGas 20	-	1115 €33	80	80-30(30)	-	80/125-30	-
	UltraGas 27	-	1115 €33	80	80-30(30)	-	80/125-30	-
	UltraGas 35	-	1115 €33	80	80-30(30)	-	80/125-30	-
	UltraGas 50	-	1115 €33	80	100-30(30)	-	100/150-30	-
	UltraGas 70	-	2115 €44	100	100-30(30)	-	100/150-30	-
	UltraGas 100	-	2115 €44	100	100-15(13)	125-30(30)	100/150-15	125/190-30
	UltraGas 2 125	2029956	-	125	125-30(27)	-	125/190-30	-
	UltraGas 2 150	2029956	-	160	160-30(30)	-	160/230-30	-
	UltraGas 2 190	2029956	-	160	160-30(30)	-	160/230-30	-
	UltraGas 2 230	6021252	-	160	160-30(30)	-	160/230-30	-
	UltraGas 2 300	6021252	-	200	200-30	-	200/265-30	-
	UltraGas 2 350	-	9107 €308	8102 €155	200	200-30	200/265-30	-
	UltraGas 2 400	-	-	200	200-30	-	200/265-30	-
	UltraGas 2 450	-	-	200	200-30	-	200/265-30	-
	UltraGas 2 500	-	-	200	200-19	250-30	200/265-19	250/315-30
	UltraGas 2 620	-	-	250	250-30	-	250/315-30	-
	UltraGas 2 700	-	9107 €308	9115 €110	250	250-30	250/315-30	-
	UltraGas 2 800	-	-	250	250-30	-	250/315-30	-
	UltraGas 2 1000 / 1100	-	-	300	300-30	-	DW300-30	-
	UltraGas 2 1300	-	-	350	350-30	-	DW350-30	-
	UltraGas 2 1550	-	-	400	400-30	-	DW400-30	-
	UltraGas 250D / 300D	-	8102 €155	8115 €77	200	200-30	200/265-30	-
	UltraGas 400D / 500D / 600D	-	9107 €308	9115 €110	250	250-30	250/315-30	-
	MultiJet 12 / MultiJet LSP	-	1115 €33	80	80-30(30)	-	80/125-30	-
	MultiJet 16 / MultiJet LSP	-	1115 €33	80	80-30(30)	-	80/125-30	-
	MultiJet 20 / MultiJet LSP	-	1115 €33	80	80-30(30)	-	80/125-30	-
	MultiJet 25	-	1115 €33	80	80-30(30)	-	80/125-30	-
	UltraOil 16 / 20	-	1115 €33	80	80-30(30)	-	80/125-30	-
	UltraOil 25	-	1115 €33	80	80-30(30)	-	80/125-30	-
	UltraOil 35	-	1115 €33	80	80-12(11)	100-30(30)	80/125-13	100/150-30
	UltraOil 50	-	2115 €44	100	100-30(29)	-	100/150-30	-
	UltraOil 65 / 80	2029956	6117 €154	6115 €75	160	125-30(30)	125/190-30	-
	UltraOil 110 / 130	-	8115 €77	200	160-30(30)	-	160/230-30	-
	UltraOil 160	-	6118 €155	6115 €75	160	160-30(30)	160/230-30	-
	UltraOil 200	-	8115 €77	200	160-22(22)	200-30	160/230-22	200/265-30
	UltraOil 250 / 300	-	9115 €110	250	200-30	-	200/265-30	-

	HOVAL	Anschlussstück	ATEC Anschlussadapter	Verbindungs-	Steigleitung	Außenwandmontage			
	raumluftunabhängig	Kesselhersteller	gerade					leitung	einwandig
	TopGas comfort RS-OT / TTE 10 / 16 / 22	-	-	80/125	80-30(30)	-	80/125-30	80/125-30	-
	TopGas combi RS-OT 21/18	-	-	80/125	80-30(30)	-	80/125-30	80/125-30	-
	TopGas combi RS-OT 26/23	-	-	80/125	80-30(30)	-	80/125-27	80/125-30	-
	TopGas combi RS-OT 32/28	-	-	80/125	80-27(25)	-	80/125-18	80/125-30	-
	TopGas classic 35 / 45	-	2220 €100	100/150	100-30(30)	-	100/150-30	100/150-30	-
	TopGas classic 60	-	2220 €100	100/150	100-24(22)	-	100/150-17	100/150-30	-
	TopGas classic 80	-	2220 €100	100/150	100-10(10)	-	100/150-7	100/150-30	-
	UltraGas 15 / UltraGas 20	6027510	-	80/125	80-30(30)	-	80/125-30	80/125-30	-
	UltraGas 27	6027510	-	80/125	80-30(30)	-	80/125-23	80/125-30	-
	UltraGas 35	6027510	-	80/125	80-27(25)	100-30(30)	80/125-18	80/125-30	-
	UltraGas 50	6027510	-	80/125	100-30(29)	-	100/150-23	100/150-30	-
	UltraGas 70	-	2220 €100	100/150	100-13(12)	125-30(30)	100/150-9	100/150-30	-
	UltraGas 100	-	2220 €100	100/150	125-14(14)	-	125/190-14	100/150-12	125/190-30
	UltraGas 2 125 bis 1550	-	-	Auf Anfrage	-	-	-	-	-
	MultiJet 12 / MultiJet LSP	-	1218 €90	80/125	80-30(30)	-	80/125-30	80/125-30	-
	MultiJet 16 / MultiJet LSP	-	1218 €90	80/125	80-30(30)	-	80/125-30	80/125-30	-
	MultiJet 20 / MultiJet LSP	-	-	80/125	80-30(30)	-	80/125-30	80/125-30	-
	MultiJet 25	-	-	80/125	80-24(22)	-	80/125-17	80/125-30	-
	UltraOil 16 / 20	6027510	-	80/125	80-30(30)	-	80/125-29	80/125-30	-
	UltraOil 25	6027510	-	80/125	80-25(23)	-	80/125-17	80/125-30	-
	UltraOil 35	6027510	-	80/125	80-7(6)	100-24(22)	80/125-4	80/125-12	100/150-30
	UltraOil 50	-	2220 €100	100/150	100-13(12)	110-28(27)	100/150-10	100/150-30	-

	INTERCAL	Anschlussstück	ATEC Anschlussadapter	Verbindungs-	Steigleitung		Außenwandmontage		
	raumluftabhängig	Kesselhersteller	gerade		leitung	einwandig			konzentrisch
	ECOHEAT Plus Gas 20 N / F	-	1115 €33	-	80	80-16(13)	100-25(24)	80/125-16	-
	ECOHEAT Streamline Gas 16 H/HE / 16/24 S/HE	-	1115 €33	-	80	80-30(30)	-	80/125-30	-
	ECOHEAT Streamline Gas 25 H/HE / 25/32 S/HE	-	1115 €33	-	80	80-30(19)	100-30(30)	80/125-30	-
	RATIOLINE Plus Gas 20 N / F	-	1115 €33	-	80	80-16(13)	-	80/125-16	-
	ECOHEAT Plus Öl 20	88.20135-249	1115 €33	-	80	80-22(17)	100-25(25)	80/125-22	-
	RATIOLINE Plus Öl 15	-	-	-	80	80-30(22)	-	80/125-30	-
	ECOHEAT Öl SC 18 / 22	88.20135-295	-	-	80	80-20(20)	-	80/125-20	-
	ECOHEAT Plus Öl 15	88.20135-249	1115 €33	-	80	80-30(22)	100-25(25)	80/125-30	-
	ECOHEAT Plus Öl 25	88.20135-249	1115 €33	-	80	80-16(13)	100-25(24)	80/125-16	-
	ECOHEAT Öl 30	88.20135-249	-	-	80	80-20(15)	-	80/125-20	-
	ECOHEAT Öl 40	88.20135-249	-	-	100	100-20(20)	-	80/125-14	-
	ECOHEAT Öl SC 26	88.20135-295	-	-	80	80-20(17)	-	80/125-20	-

	INTERCAL	Anschlussstück	ATEC Anschlussadapter	Verbindungs-	Steigleitung		Außenwandmontage		
	raumluftunabhängig	Kesselhersteller	gerade		leitung	einwandig			konzentrisch
	ECOHEAT Plus Gas 20 N / F	-	-	-	80/125	80-14(11)	100-30(30)	80/125-12	-
	ECOHEAT Streamline Gas 16 H/HE / 16/24 S/HE	-	-	-	80/125	80-23(20)	-	80/125-12	80/125-30
	ECOHEAT Streamline Gas 25 H/HE / 25/32 S/HE	-	-	-	80/125	80-19(13)	-	80/125-21	80/125-30
	RATIOLINE Plus Gas 20 N / F	-	-	-	80/125	80-14(11)	-	-	80/125-14
	ECOHEAT Plus Öl 20	88.20135-250	-	-	80/125	80-20(15)	100-25(25)	-	80/125-20
	RATIOLINE Plus Öl 15	-	-	-	80/125	80-25(20)	-	-	80/125-21
	ECOHEAT Öl SC 18 / 22	88.20135-296	-	-	80/125	80-18(15)	-	-	80/125-20
	ECOHEAT Plus Öl 15	88.20135-250	-	-	80/125	80-25(20)	-	-	80/125-25
	ECOHEAT Plus Öl 25	88.20135-250	-	-	80/125	80-14(11)	100-25(25)	-	80/125-14
	ECOHEAT Öl SC 26	88.20135-296	-	-	80/125	80-14(11)	100-20(20)	-	80/125-20

	INTERDOMO	Anschlussstück	ATEC Anschlussadapter	Verbindungs-	Steigleitung		Außenwandmontage		
	raumluftabhängig	Kesselhersteller	gerade		leitung	einwandig			konzentrisch
	Domostar GBK-15 / Plus 15-200 / floor 15	-	-	-	60	60-30(30)	-	60/100-30	-
	Domostar GBK-35 / floor 35 / GBK-25 x-floor-	-	-	-	60	60-13(8)	80-30(30)	60/100-13	80/125-30
	bicon OBK-17	-	1115 €33	-	80	80-30(29)	-	80/125-30	-
	bicon OBK-24	-	1115 €33	-	80	80-30(23)	-	80/125-30	-

	INTERDOMO	Anschlussstück	ATEC Anschlussadapter	Verbindungs-	Steigleitung		Außenwandmontage		
	raumluftunabhängig	Kesselhersteller	gerade		leitung	einwandig			konzentrisch
	Domostar GBK-25 / GBK-25C / GBK-25CSI / Plus 25-200 / floor 25	-	-	-	60/100	60-21(14)	80-30(30)	60/100-17	60/100-24
	Domostar GBK-35 / floor 35 / GBK-25 x-floor-	-	-	-	60/100	60-11(7)	80-30(30)	60/100-9	60/100-11

	MHG HEIZTECHNIK	Anschlussstück	ATEC Anschlussadapter	Verbindungs-	Steigleitung		Außenwandmontage		
	raumluftabhängig	Kesselhersteller	gerade		leitung	einwandig			konzentrisch
	ecoGAS 11	-	-	-	60	60-28(28)	-	60/100-30	-
	ecoGAS 18 Heizer / ecoGAS Kompakt	-	1137 €35	-	60	60-17(13)	80-30(30)	60/100-17	80/125-30
	ecoGAS 24 Heizer	-	1137 €35	-	80	80-30(30)	-	80/125-30	-
	ecoGAS 30 Heizer	-	-	-	80	80-28(28)	-	80/125-28	-
	ecoGAS 45 Heizer	-	-	-	80	80-18(14)	-	80/125-18	-
	ecoGAS 18/24 Kombi	-	-	-	60	80-17(13)	80-30(30)	60/100-17	80/125-30
	ecoGAS 24/28 Kombi	-	1137 €35	-	80	80-30(30)	-	80/125-30	-
	ecoGAS 30/36 Kombi	-	-	-	80	80-28(28)	-	80/125-28	-
	ecoGAS 45/36 Kombi	-	-	-	80	80-18(14)	100-30(30)	80/125-18	-
	ecoGAS Pro 18	-	-	-	60	60-30(30)	-	60/100-30	-
	ecoGAS Pro 24	-	-	-	60	60-27(25)	-	60/100-30	-
	ecoGAS Pro 30	-	-	-	60	60-23(21)	80-30(30)	60/100-23	80/125-30
	ecoGAS Pro X 18/26	-	-	-	60	60-28(25)	80-30(30)	60/100-28	80/125-30
	ecoGAS Pro X 30/38	-	-	-	60	60-17(13)	80-30(30)	60/100-16	80/125-30
	ProCon E 20 / E 25	-	1115 €33	-	80	80-30(30)	-	80/125-30	-
	ProCon E 30	-	1115 €33	-	80	80-30(30)	-	80/125-30	-
	ProCon E 35	-	1115 €33	-	80	80-30(30)	-	80/125-30	-
	ProCon Kompakt	-	-	-	80	80-30(30)	-	80/125-30	-
	ProCon Streamline 16 + 25 / H+S	94.61300-4307	1115 €33	-	80	80-30(30)	-	80/125-30	-
	ecoOel 15	-	0130 €32	-	60	60-25(17)	-	60/100-25	-
	ecoOel 16	-	0130 €32	-	60	60-22(14)	-	60/100-22	-
	ecoOel 20	-	1115 €33	-	80	80-30(30)	-	80/125-30	-
	ecoOel 24 / 27 / 30	-	1115 €33	-	80	80-29(20)	-	80/125-29	-
	ecoOel 37 / 38	-	1115 €33	-	80	80-15(10)	100-30(30)	80/125-15	-
	ecoOel ES 18	-	1115 €33	-	80	80-30(30)	-	80/125-30	-
	ecoOel ES 22	-	1115 €33	-	80	80-30(21)	-	80/125-30	-
	ecoOel ES 26	-	1115 €33	-	80	80-25(17)	-	80/125-25	-
	EcoStar 753 - 755	94.68100-420	-	-	100	100-30(30)	-	100/150-30	-
	EcoStar 756	94.68100-420	-	-	100	100-20(14)	-	100/150-22	-
	EcoStar plus 15 E /HS	-	1115 €33	-	80	80-30(30)	-	80/125-30	-
	EcoStar plus 18 M /HS	-	1115 €33	-	80	80-30(30)	-	80/125-30	-
	EcoStar plus 20 E /HS	-	1115 €33	-	80	80-30(30)	-	80/125-30	-
	EcoStar plus 25 E/HS / M/HS	-	1115 €33	-	80	80-30(30)	-	80/125-30	-

	MHG HEIZTECHNIK	Anschlussstück	ATEC Anschlussadapter	Verbindungs-	Steigleitung		Außenwandmontage		
	raumluftunabhängig	Kesselhersteller	gerade		leitung	einwandig			konzentrisch
	ecoGAS 11	-	-	-	60/100	60-30(30)	-	60/100-26	60/100-26
	ecoGAS 18 Heizer / ecoGAS Kompakt	-	-	-	60/100	60-15(10)	80-30(30)	60/100-9	60/100-9
	ecoGAS 24 Heizer	-	-	-	80/125	80-28(28)	-	80/125-28	80/125-28
	ecoGAS 30 Heizer	-	-	-	80/125	80-20(18)	100-30(30)	80/125-20	80/125-20

Fortsetzung MHG Heiztechnik raumluftunabhängig

ecoGAS 45 Heizer	-	-	-	80/125	80-12(11)	100-20(16)	80/125-9	80/125-9	-
ecoGAS 18/24 Kombi	-	-	-	60/100	60-15(10)	80-30(30)	60/100-9	60/100-9	80/125-30
ecoGAS 24/28 Kombi	-	-	-	80/125	80-28(28)	100-30(30)	80/125-28	80/125-28	-
ecoGAS 30/36 Kombi	-	-	-	80/125	80-20(18)	100-30(30)	80/125-20	80/125-20	-
ecoGAS 45/36 Kombi	-	-	-	80/125	80-12(11)	100-20(16)	80/125-9	80/125-9	-
ecoGAS Pro 18	-	-	-	60/100	60-30(30)	-	60/100-30	60/100-30	-
ecoGAS Pro 24	-	-	-	60/100	60-27(25)	80-30(30)	60/100-21	60/100-30	-
ecoGAS Pro 30	-	-	-	60/100	60-19(18)	80-30(30)	60/100-15	60/100-23	80/125-30
ecoGAS Pro X 18/26	-	-	-	60/100	60-24(22)	80-30(30)	60/100-19	60/100-27	80/125-30
ecoGAS Pro X 30/38	-	-	-	60/100	60-13(12)	80-30(30)	60/100-11	60/100-15	80/125-30
ProCon E 20 / E 25	erforderlich	-	-	80/125	80-30(30)	-	80/125-30	80/125-30	-
ProCon E 30	-	-	-	80/125	80-30(27)	-	80/125-26	80/125-30	-
ProCon E 35	-	-	-	80/125	80-30(30)	-	80/125-30	80/125-30	-
ProCon Kompakt	-	-	-	80/125	80-30(30)	-	80/125-29	80/125-30	-
ProCon Streamline 16 + 25 / H+S	94.61300-4307	-	-	80/125	80-29(21)	-	80/125-21	80/125-30	-
ecoOel 15	-	-	-	60/100	60-19(14)	-	60/100-15	60/100-23	-
ecoOel 16	-	-	-	60/100	60-17(12)	-	60/100-13	60/100-20	-
ecoOel 20	-	-	-	80/125	80-30(27)	-	80/125-26	80/125-30	-
ecoOel 24 / 27 / 30	-	-	-	80/125	80-18(14)	-	80/125-13	80/125-25	-
ecoOel 37 / 38	-	-	-	80/125	80-9(6)	100-22(19)	80/125-6	80/125-11	-
ecoOel ES 18	-	-	-	80/125	80-26(21)	-	80/125-21	80/125-30	-
ecoOel ES 22	-	-	-	80/125	80-18(14)	-	80/125-14	80/125-27	-
ecoOel ES 26	-	-	-	80/125	80-15(11)	-	80/125-11	80/125-21	-
EcoStar plus 15 E /-HS	-	-	-	80/125	80-30(30)	-	80/125-30	80/125-30	-
EcoStar plus 18 M /-HS	-	-	-	80/125	80-30(30)	-	80/125-27	80/125-30	-
EcoStar plus 20 E /-HS	-	-	-	80/125	80-30(30)	-	80/125-24	80/125-30	-
EcoStar plus 25 E/-HS / M/-HS	-	-	-	80/125	80-22(22)	-	80/125-22	80/125-30	-



PARADIGMA	Anschlussstück Kesselhersteller	ATEC Anschlussadapter gerade	Verbindungsleitung	Steigleitung einwandig	Außenwandmontage
raumluftunabhängig					
PMA maxi 45	-	-	80	80-30(27)	80/125-30 -
PMA maxi 65	-	-	100	100-25(17)	100/150-25 -
PMA maxi 85	-	-	100	100-28(24)	100/150-28 -
PMA maxi 115	-	-	100	100-21(18)	100/150-21 -
ModuVario NT 15	-	-	60	60-24(21)	60/100-24 80/125-30
ModuVario NT 25	-	-	60	80-30(30)	80/125-30 -
PMA 10 / PMA 15 / PMA 25 / PMA 28 Kombi	-	-	80	80-30(30)	80/125-30 -
PMA 35	-	-	80	80-30(30)	80/125-30 -
PMI 13 / PMI 22	-	-	80	80-30(30)	80/125-30 -
PMI 31	-	-	80	80-30(30)	80/125-30 -



PARADIGMA	Anschlussstück Kesselhersteller	ATEC Anschlussadapter gerade	Verbindungsleitung	Steigleitung einwandig	konzentrisch	Außenwandmontage
raumluftunabhängig						
PMA maxi 45	-	-	80/125	80-18(16)	100-30(30)	80/125-13 80/125-30 -
PMA maxi 65	-	-	100/150	100-12(10)	125-30(27)	100/150-10 100/150-20 -
PMA maxi 85	-	-	100/150	100-11(10)	110-20(19)	100/150-8 100/150-27 -
PMA maxi 115	-	-	100/150	100-8(7)	125-26(25)	100/150-7 100/150-19 125/190-30
ModuVario NT 15	-	-	60/100	60-22(20)	80-30(30)	60/100-15 60/100-24 80/125-30
ModuVario NT 25	-	-	60/100	80-22(21)	-	80/125-16 80/125-30 -
PMA 10 / PMA 15 / PMA 25 / PMA 28 Kombi	-	-	80/125	80-30(30)	-	80/125-30 80/125-30 -
PMA 35	-	-	80/125	80-30(30)	-	80/125-20 80/125-30 -
PMI 13 / PMI 22	-	-	80/125	80-30(30)	-	80/125-30 80/125-30 -
PMI 31	-	-	80/125	80-30(30)	-	80/125-23 80/125-30 -



RADIANT	Anschlussstück Kesselhersteller	ATEC Anschlussadapter gerade	Verbindungsleitung	Steigleitung einwandig	Außenwandmontage
raumluftunabhängig					
R1K 24/B / R2K 24 / R2KA 24/8 / R2KA 24/100-	-	1115 €33	80	80-30(30)	80/125-30 -
R1K 28/B / R2K 28	-	1115 €33	80	80-30(30)	80/125-30 -
R1K 34/B / R2K 34	-	1115 €33	80	80-30(29)	80/125-30 -
R1K 50	-	1115 €33	80	80-13(11)	80/125-13 100/150-30
R1K 100	-	1137 €35	80	110-22(20)	110/160-22 125/190-30



RADIANT	Anschlussstück Kesselhersteller	ATEC Anschlussadapter gerade	Verbindungsleitung	Steigleitung einwandig	konzentrisch	Außenwandmontage
raumluftunabhängig						
R1K 24/B / R2K 24 / R2KA 24/8 / R2KA 24/100-	-	-	80/125	80-30(30)	-	80/125-30 80/125-30 -
R1K 28/B / R2K 28	-	-	80/125	80-30(30)	-	80/125-28 80/125-30 -
R1K 34/B / R2K 34	-	-	80/125	80-21(19)	100-30(30)	80/125-13 80/125-30 -
R1K 50	-	-	80/125	80-7(6)	100-23(21)	80/125-5 80/125-12 100/150-30
R1K 100	-	-	Auf Anfrage	-	-	- -



REMEHA	Anschlussstück Kesselhersteller	ATEC Anschlussadapter gerade	Verbindungsleitung	Steigleitung einwandig	Außenwandmontage
raumluftunabhängig					
Avanta Plus GMR 1024 solo / combi	-	-	80	80-30(30)	80/125-30 -
Calenta Ace 15 DS	-	-	60	60-24(24)	60/100-24 -
Calenta Ace 25 DS / 25 L	-	-	60	60-10(9)	60/100-10 80/125-30
Calenta Ace Combi 28 C	-	-	60	60-7(6)	80-30(30) -
Calenta Ace 35 DS	-	-	80	80-30(30)	80/125-30 -
CALORA Tower Gas 15S	-	-	60	60-24(21)	80-30(30) -
CALORA Tower Gas 25S	-	-	60	80-30(30)	80/125-30 -
CALORA Tower Gas 35S	-	-	80	80-30(30)	80/125-30 -
Quinta Ace 45	-	-	80	80-30(27)	80/125-30 -
Quinta Ace 65	-	-	100	100-30(30)	100/150-30 -

Fortsetzung Remeha raumluftabhängig

Quinta Ace 90	-	-	-	100	100-28(24)	-	-	100/150-28	-
Quinta Ace 115	-	3151 €59	-	100	100-21(18)	125-30(30)	-	100/150-21	-
Quinta Ace 160	-	4101 €118	-	125	125-23(22)	160-30(30)	-	125/190-23	160/230-30
Tzerra Ace 15DS	-	-	-	60	60-14(12)	80-30(30)	-	60/100-14	80/125-30
Tzerra Ace 24 DS	-	-	-	60	60-6(6)	80-30(30)	-	60/100-6	80/125-30
Tzerra Ace 28 C	-	-	-	60	80-30(30)	-	-	80/125-30	-
Gas 120 Ace 45	-	-	-	80	80-30(27)	-	-	80/125-30	-
Gas 120 Ace 65	-	-	-	100	100-30(30)	-	-	100/150-30	-
Gas 120 Ace 90	-	-	-	100	100-28(24)	110-30(30)	-	100/150-28	110/160-30
Gas 120 Ace 115	-	-	-	100	100-21(18)	110-30(30)	-	100/150-21	110/160-30
Gas 210 Ace 80	-	4101 €118	4115 €60	125	125-30(30)	-	-	125/190-30	-
Gas 210 Ace 120	-	4101 €118	4115 €60	125	125-30(30)	-	-	125/190-30	-
Gas 210 Ace 160	-	6117 €154	6115 €75	160	125-14(13)	160-30(30)	-	125/190-13	160/230-30
Gas 210 Ace 200	-	6117 €154	6115 €75	160	160-30(30)	-	-	160/230-30	-
Gas 220 Ace 160	-	4101 €118	4115 €60	125	125-23(22)	160-30(30)	-	125/190-23	160/230-30
Gas 220 Ace 200	-	6103 €155	6115 €75	160	160-30(30)	-	-	160/230-30	-
Gas 220 Ace 250	-	6103 €155	6115 €75	160	160-26(25)	200-30	-	160/230-26	200/265-30
Gas 220 Ace 300	-	6103 €155	6115 €75	160	160-13(12)	200-30	-	160/230-12	200/265-30
Gas 320 Ace 285	-	6112 €155	6115 €75	160	160-18(18)	200-30	-	160/230-18	200/265-30
Gas 320 Ace 355	-	8102 €155	8115 €77	200	200-30	-	-	200/265-30	-
Gas 320 Ace 430	-	8102 €155	8115 €77	200	200-30	-	-	200/265-30	-
Gas 320 Ace 500	-	8102 €155	8115 €77	200	200-28	-	-	200/265-28	-
Gas 320 Ace 575	-	8102 €155	8115 €77	200	200-14	250-30	-	200/265-13	250/315-30
Gas 320 Ace PRO 650	-	9115 €110	-	250	200-10	250-30	-	200/265-10	250/315-
Gas 620 Ace 570	-	9105 €320	9115 €110	250	250-30	-	-	250/315-30	-
Gas 620 Ace 710	-	9105 €320	9115 €110	250	250-30	-	-	250/315-30	-
Gas 620 Ace 860	-	9105 €320	9115 €110	250	250-20	-	-	250/315-20	-
Gas 620 Ace 1000	-	-	-	300	300-30	-	-	DW300-30	-
Gas 620 Ace 1150	-	-	-	350	350-30	-	-	DW350-30	-
Gas 620 Ace 1300	-	-	-	350	350-30	-	-	DW350-30	-
Calora Tower Ace Öl 18 LS, 24 LS	-	-	-	80	80-11(10)	100-28(26)	-	80/125-11	100/150-28
Calora Tower Ace Öl 30 LS	-	-	-	80	80-15(13)	100-30(30)	-	80/125-15	100/150-30



REMEHA	Anschlussstück Kesselhersteller	ATEC Anschlussadapter gerade	Verbindungs- leitung	Steigleitung einwandig	konzentrisch	Außenwandmontage
raumluftunabhängig						
Avanta Plus GMR 1024 solo / combi	-	-	80/125	80-19(18)	100-30(30)	80/125-13 80/125-30
Calenta Ace 15 DS	-	-	60/100	60-17(16)	80-30(30)	60/100-13 60/100-24
Calenta Ace 25 DS / 25 L	-	-	60/100	60-7(6)	80-30(30)	60/100-5 60/100-9
Calenta Ace Combi 28 C	-	-	60/100	80-26(24)	-	80/125-18 80/125-30
Calenta Ace 35 DS	-	-	80/125	80-26(24)	-	80/125-18 80/125-30
CALORA Tower Gas 15S	-	-	60/100	60-22(20)	80-30(30)	60/100-15 60/100-24
CALORA Tower Gas 25S	-	-	60/100	80-22(21)	-	80/125-16 80/125-30
CALORA Tower Gas 35S	-	-	80/125	80-26(24)	-	80/125-18 80/125-30
Quinta Ace 45	-	-	80/125	80-18(16)	100-30(30)	80/125-13 80/125-30
Quinta Ace 65	-	-	100/150	100-12(11)	110-23(22)	100/150-9 100/150-30
Quinta Ace 90	-	-	100/150	100-11(10)	110-20(19)	100/150-8 100/150-27
Quinta Ace 115	-	-	100/150	100-8(7)	125-26(25)	100/150-7 100/150-19
Quinta Ace 160	-	-	Auf Anfrage	-	-	-
Tzerra Ace 15DS	-	-	60/100	60-8(7)	80-30(30)	60/100-7 60/100-13
Tzerra Ace 24 DS	-	-	60/100	80-22(20)	-	80/125-15 60/100-6
Tzerra Ace 28 C	-	-	60/100	80-27(25)	-	80/125-19 80/125-30
Gas 120 Ace 45	-	-	80/125	80-17(16)	100-30(30)	80/125-12 80/125-30
Gas 120 Ace 65	-	-	100/150	100-11(10)	110-21(20)	100/150-8 100/150-30
Gas 120 Ace 90	-	-	100/150	100-9(9)	110-18(17)	100/150-7 100/150-26
Gas 120 Ace 115	-	-	100/150	110-14(13)	125-23(22)	100/150-5 100/150-19
Gas 210 Ace 80 bis 300	-	-	Auf Anfrage	-	-	-
Calora Tower Ace Öl 18 LS, 24 LS	-	-	80/125	80-10(10)	100-26(25)	80/125-7 80/125-14
Calora Tower Ace Öl 30 LS	-	-	80/125	80-9(8)	100-30(30)	80/125-6 80/125-15



SCHEER	Anschlussstück Kesselhersteller	ATEC Anschlussadapter gerade	Verbindungs- leitung	Steigleitung einwandig	konzentrisch	Außenwandmontage
raumluftunabhängig						
Öltherme DUOCondens/Wärmezentrum 12/14/17/19 kW	-	1270 €94	-	80/125	80-30(30)	80/125-30 80/125-30
Öltherme DUOCondens/Wärmezentrum 17-25 kW	-	1270 €94	-	80/125	80-30(24)	80/125-24 80/125-30
Öltherme DUOCondens/Wärmezentrum 20-30 kW	-	1270 €94	-	80/125	80-25(19)	80/125-18 80/125-30



SOLVIS	Anschlussstück Kesselhersteller	ATEC Anschlussadapter gerade	Verbindungs- leitung	Steigleitung einwandig	Außenwandmontage
raumluftabhängig					
SolvisBen SX-LN 10	-	0130 €32	-	60	60-30(30)
SolvisBen SX-LN 18	-	0130 €32	-	60	60-29(26)
SolvisBen SX-LN 25	-	-	-	80	80-30(30)
SolvisBen SX-LN 30	-	-	-	80	80-30(30)
SolvisMax SX-LN 10	-	0130 €32	-	60	60-30(30)
SolvisMax SX-LN 18	-	0130 €32	-	60	60-29(26)
SolvisMax SX-LN 25	-	-	-	80	80-30(30)
SolvisMax SX-LN 30	-	-	-	80	80-30(30)
SolvisBen Öl 10/17	-	1115 €33	-	80	80-30(30)
SolvisBen Öl 14/23	-	1115 €33	-	80	80-30(30)
SolvisMax SÖ-BW 17	-	-	-	80	80-30(30)
SolvisMax SÖ-BW 23	-	-	-	80	80-30(27)
SolvisMax SÖ-BW 28	-	-	-	80	80-30(22)



SOLVIS	Anschlussstück Kesselhersteller	ATEC Anschlussadapter gerade		Verbindungs- leitung	Steigleitung einwandig	konzentrisch	Außenwandmontage	
raumluftunabhängig								
SolvisBen SX-LN 10	-	-	-	60/100	60-30(30)	-	60/100-30	60/100-30 -
SolvisBen SX-LN 18	-	-	-	60/100	60-25(23)	-	60/100-18	60/100-29 -
SolvisBen SX-LN 25	-	-	-	80/125	80-30(30)	-	80/125-30	80/125-30 -
SolvisBen SX-LN 30	-	-	-	80/125	80-30(30)	-	80/125-30	80/125-30 -
SolvisMax SX-LN 10	-	-	-	60/100	60-30(30)	-	60/100-30	60/100-30 -
SolvisMax SX-LN 18	-	-	-	60/100	60-25(23)	-	60/100-18	60/100-29 -
SolvisMax SX-LN 25	-	-	-	80/125	80-30(30)	-	80/125-30	80/125-30 -
SolvisMax SX-LN 30	-	-	-	80/125	80-30(30)	-	80/125-30	80/125-30 -
SolvisBen Öl 10/17	-	-	-	80/125	80-30(30)	-	80/125-30	80/125-30 -
SolvisBen Öl 14/23	-	-	-	80/125	80-30(30)	-	80/125-30	80/125-30 -
SolvisMax SÖ-BW 17	-	-	-	80/125	80-30(30)	-	80/125-30	80/125-30 -
SolvisMax SÖ-BW 23	-	-	-	80/125	80-24(19)	-	80/125-19	80/125-30 -
SolvisMax SÖ-BW 28	-	-	-	80/125	80-20(16)	-	80/125-16	80/125-28 -



VAILLANT	Anschlussstück Kesselhersteller	ATEC Anschlussadapter gerade		Verbindungs- leitung	Steigleitung einwandig		Außenwandmontage	
raumluftabhängig								
ecoCraft VKK 806/3-E	-	4101 €118	4115 €60	125	125-30(30)	-	-	125/190-30 -
ecoCraft VKK 1206/3-E	-	4101 €118	4115 €60	125	125-30(28)	-	-	125/190-30 -
ecoCraft VKK 1606/3-E	-	6101 €133	6115 €75	160	160-30(30)	-	-	160/230-30 -
ecoCraft VKK 2006/3-E	-	6118 €155	6115 €75	160	160-30(30)	-	-	160/230-30 -
ecoCraft VKK 2406/3-E	-	8115 €77	-	200	200-30	160-30(26)	-	160/230-30 -
ecoCraft VKK 2806/3-E	-	8115 €77	-	200	200-30	-	-	200/265-30 -
ecoVIT VKK 226 bis 476	-	-	-	80	80-30(30)	-	-	80/125-20 -
icoVIT exklusiv VKO 156/3-7	-	-	-	80	80-30(30)	-	-	80/125-20 -
icoVIT exklusiv VKO 256/3-7S	-	-	-	80	80-30(30)	-	-	80/125-30 -
icoVIT exklusiv VKO 356/3-7	-	-	-	80	80-28(18)	-	-	80/125-28 -



VISSMANN	Anschlussstück Kesselhersteller	ATEC Anschlussadapter gerade		Verbindungs- leitung	Steigleitung einwandig		Außenwandmontage	
raumluftabhängig								
Vitocrossal 200 CIB 80	-	3106 €189	-	110	110-27(24)	125-30(30)	-	110/160-26 125/190-30
Vitocrossal 200 CIB 120	-	4113 €161	-	125	125-20(19)	160-30(30)	-	125/190-20 -
Vitocrossal 200 CIB 160	-	6103 €155	-	160	160-30(30)	-	-	160/230-30 -
Vitocrossal 200 CIB 200	-	6103 €155	-	160	160-30(30)	-	-	160/230-30 -
Vitocrossal 200 CIB 240	-	6103 €155	-	160	200-30	-	-	200/265-30 -
Vitocrossal 200 CIB 280	-	6103 €155	-	160	200-30	-	-	200/265-30 -
Vitocrossal 200 CIB 318	-	6103 €155	-	160	200-30	-	-	200/265-30 -
Vitocrossal 200 CM2 400	-	8102 €155	-	200	200-30	-	-	200/265-30 -
Vitocrossal 200 CM2 500 / CM2 620	-	-	-	250	250-30	-	-	250/315-30 -
Vitocrossal 300 CM3C 87	-	4104 €118	-	125	125-30(30)	-	-	125/190-30 -
Vitocrossal 300 CM3C 115	-	4104 €118	-	125	125-30(29)	-	-	125/190-30 -
Vitocrossal 300 CM3C 142	-	4104 €118	-	125	125-13(12)	160-30(30)	-	125/190-13 160/230-30
Vitocrossal 300 CM3C 186	-	6103 €155	-	160	160-30(30)	-	-	160/230-30 -
Vitocrossal 300 CM3C 246	-	-	-	200	160-23(23)	200-30(30)	-	160/230-23 200/265-30
Vitocrossal 300 CM3C 311	-	-	-	200	200-30	-	-	200/265-30 -
Vitocrossal 300 CR3B 787	-	-	-	300	300-30	-	-	DW300-30 -
Vitocrossal 300 CR3B 978	-	-	-	300	300-30	-	-	DW300-30 -
Vitocrossal 300 CR3B 1100	-	-	-	350	350-30	-	-	DW350-30 -
Vitocrossal 300 CR3B 1400	-	-	-	350	350-30	-	-	DW350-30 -
Vitocrossal 300 CRU 800 / CRU 1000	-	-	-	300	300-30	-	-	DW300-30 -
Vitocrossal 300 CT3B 187	-	6118 €155	6115 €75	160	160-30(23)	-	-	160/230-30 -
Vitocrossal 300 CT3B 248	-	8115 €77	-	200	160-23(23)	200-30	-	160/230-23 200/265-30
Vitocrossal 300 CT3B 314	-	8115 €77	-	200	200-30	-	-	200/265-30 -
Vitocrossal 300 CT3B 408	-	9115 €110	-	250	200-30	-	-	200/265-30 -
Vitocrossal 300 CT3B 508	-	9115 €110	-	250	200-12	250-30	-	200/265-12 250/315-30
Vitocrossal 300 CT3B 635	-	9115 €110	-	250	250-30	-	-	250/315-30 -
Vitocrossal 300 CT3U 400	-	8102 €155	8115 €77	200	200-30	-	-	200/260-30 -
Vitocrossal 300 CT3U 500	-	9115 €110	-	250	200-12	250-30	-	200/265-12 250/315-30
Vitocrossal 300 CT3U 630	-	9115 €110	-	250	250-30	-	-	250/315-30 -
Vitocrossal 300 CU3A 13	-	0130 €32	-	60	60-30(30)	-	-	60/100-30 -
Vitocrossal 300 CU3A 19	-	-	-	80	60-15(14)	80-30(30)	-	60/100-16 80/125-30
Vitocrossal 300 CU3A 26	-	-	-	80	80-30(30)	-	-	80/125-30 -
Vitocrossal 300 CU3A 35	-	-	-	80	80-18(15)	100-30(30)	-	80/125-18 100/150-30
Vitocrossal 300 CU3A 45	-	2232 €51	-	100	100-30(30)	-	-	100/150-30 -
Vitocrossal 300 CU3A 60	-	2232 €51	-	100	110-30(30)	-	-	110/160-30 -
Vitodens 200-W B2KB / 222-F B2TB/B2SB / 222-W B2LB 26	-	-	-	60	60-14(12)	80-30(30)	-	60/100-13 80/125-30
Vitodens 200-W B2KB / 222-F B2TB / 222-W B2LB 35	-	-	-	60	80-30(30)	-	-	80/125-30 -
Vitodens 200-W B2HF / 222-F B2TF-B2SF / 222-F B2LF 11	-	-	-	60	60-30(30)	-	-	60/100-30 -
Vitodens 200-W B2HF / 222-F B2TF-B2SF / 222-F B2LF 19	-	-	-	60	60-30(30)	-	-	60/100-30 -
Vitodens 200-W B2HF 25	-	-	-	60	60-27(24)	-	-	60/100-27 -
Vitodens 200-W B2HF 32	-	-	-	60	60-14(12)	80-30(30)	-	60/100-14 80/125-30
Vitodens 200-W B2KF 19	-	-	-	60	60-17(15)	80-30(30)	-	60/100-17 80/125-30
Vitodens 200-W B2KF 25	-	-	-	60	60-12(10)	80-30(30)	-	60/100-12 80/125-30
Vitodens 200-W B2KF 32	-	-	-	60	60-9(8)	80-30(30)	-	60/100-9 80/125-30
Vitodens 200-W B2HA 49	-	-	-	80	80-30(30)	-	-	80/125-30 -
Vitodens 200-W B2HA 60	-	-	-	80	80-20(17)	100-30(30)	-	80/125-20 100/150-30
Vitodens 200-W B2HA 80	-	2232 €51	-	100	100-30(30)	-	-	100/150-30 -
Vitodens 200-W B2HA 99	-	-	-	110	110-30(30)	-	-	110/160-30 -
Vitodens 200-W B2HA 120	-	-	-	110	110-30(27)	125-30(30)	-	110/160-30 -
Vitodens 200-W B2HA 150	-	-	-	110	110-19(17)	125-30(30)	-	110/160-19 125/190-30
Vitodens 222-F B2TF-B2SF / 222-F B2LF 25	-	-	-	60	60-14(12)	80-30(30)	-	60/100-14 80/125-30
Vitodens 222-F B2TF / 222-F B2LF 32	-	-	-	60	80-30(30)	-	-	80/125-30 -
Vitodens 333-F B3TG 11	-	-	-	60	60-30(30)	-	-	60/100-30 -
Vitodens 333-F B3TG 19	-	-	-	60	60-30(30)	-	-	60/100-30 -
Vitodens 333-F B3TG 26	-	-	-	60	60-23(21)	80-30(30)	-	60/100-23 80/125-30

Fortsetzung Viessmann raumluftabhängig

Vitodens 300-W B3HG 11	-	-	-	60	60-30(30)	-	-	60/100-30	-
Vitodens 300-W B3HG 19	-	-	-	60	60-30(30)	-	-	60/100-30	-
Vitodens 300-W B3HG 26	-	-	-	60	60-26(23)	80-30(30)	-	60/100-26	80/125-30
Vitodens 333-F B3TG 26	-	-	-	60	60-23(21)	80-30(30)	-	60/100-23	80/125-30
Vitoladens 300-C BC3B/J3RB 19 / 23	-	1115 €33	-	80	80-30(30)	-	-	80/125-30	-
Vitoladens 300-C BC3B/J3RB 29	-	1115 €33	-	80	80-30(30)	-	-	80/125-30	-
Vitoladens 300-T VW3B 33	-	-	-	80	80-30(27)	100-30(30)	-	80/125-30	-
Vitoladens 300-T VW3B 40	-	2232 €51	-	100	100-30(30)	-	-	100/150-30	-
Vitoladens 300-T VW3B 50	-	2232 €51	-	100	100-30(27)	-	-	100/150-30	-
Vitorondens 200-T BR2A 20	-	-	-	80	80-30(30)	-	-	80/125-30	-
Vitorondens 200-T BR2A 24	-	-	-	80	80-30(30)	-	-	80/125-30	-
Vitorondens 200-T BR2A 28	-	-	-	80	80-30(30)	-	-	80/125-30	-
Vitorondens 200-T BR2A 33	-	-	-	80	80-30(27)	-	-	80/125-30	-
Vitorondens 200-T BR2A 40	-	2232 €51	-	100	100-30(30)	-	-	100/150-30	-
Vitorondens 200-T BR2A 50	-	2232 €51	-	100	100-30(30)	-	-	100/150-30	-
Vitorondens 200-T J2RA 63	-	-	-	110	110-30(30)	-	-	110/160-30	-
Vitorondens 200-T J2RA 80	-	-	-	110	110-26(24)	-	-	110/160-26	-
Vitorondens 200-T J2RA 100	-	-	-	110	110-13(12)	125-30(30)	-	110/160-13	125/190-30



VISSMANN	Anschlussstück Kesselhersteller	ATEC Anschlussadapter gerade	Verbindungsleitung	Steigleitung einwandig	konzentrisch	Außenwandmontage
raumluftunabhängig						
Vitocrossal 200 CM2 400 / CM2 500 / CM2 620 -	-	-	auf Anfrage	-	-	-
Vitocrossal 300 CM3C 87 bis CM3C 311	-	-	auf Anfrage	-	-	-
Vitocrossal 300 CU3A 13	-	-	60/100	60-30(30)	60/100-24	60/100-30
Vitocrossal 300 CU3A 19	-	-	80/125	60-14(12)	80-30(30)	60/100-9
Vitocrossal 300 CU3A 26	-	-	80/125	80-29(26)	80/125-16	80/125-30
Vitocrossal 300 CU3A 35	-	-	80/125	80-12(10)	100-30(30)	80/125-6
Vitocrossal 300 CU3A 45	-	-	110/160	110-30(30)	110/160-22	110/160-30
Vitocrossal 300 CU3A 60	-	-	110/160	110-20(19)	125-30(30)	110/160-9
Vitodens 200-W B2KB / 222-F B2TB/B2SB / 222-W B2LB 26	-	-	60/100	60-11(10)	80-30(30)	60/100-8
Vitodens 200-W B2KB / 222-F B2TB / 222-W B2LB 35	-	-	60/100	80-30(30)	-	80/125-26
Vitodens 200-W B2HF / 222-F B2TF-B2SF / 222-F B2LF 11	-	-	60/100	60-30(30)	-	60/100-30
Vitodens 200-W B2HF / 222-F B2TF-B2SF / 222-F B2LF 19	-	-	60/100	60-30(30)	-	60/100-30
Vitodens 200-W B2HF 25	-	-	60/100	60-24(22)	-	60/100-19
Vitodens 200-W B2HF 32	-	-	60/100	60-12(11)	80-30(30)	60/100-9
Vitodens 200-W B2KF 19	-	-	60/100	60-15(13)	80-30(30)	60/100-10
Vitodens 200-W B2KF 25	-	-	60/100	60-10(8)	80-30(30)	60/100-7
Vitodens 200-W B2KF 32	-	-	60/100	60-7(7)	80-30(30)	80/125-25
Vitodens 200-W B2HA 49	-	-	80/125	80-30(27)	-	80/125-19
Vitodens 200-W B2HA 60	-	-	80/125	80-14(12)	100-30(30)	80/125-8
Vitodens 200-W B2HA 80	-	-	110/160	110-30(30)	-	110/160-22
Vitodens 200-W B2HA 99	-	-	110/160	110-24(23)	-	110/160-12
Vitodens 200-W B2HA 120	-	-	110/160	110-13(12)	125-25(25)	110/160-6
Vitodens 200-W B2HA 150	-	-	110/160	110-8(7)	125-16(15)	110/160-4
Vitodens 222-F B2TF-B2SF / 222-F B2LF 25	-	-	60/100	60-12(11)	80-30(30)	60/100-9
Vitodens 222-F B2TF / 222-F B2LF 32	-	-	60/100	80-30(30)	-	80/125-30
Vitodens 333-F B3TG 11	-	-	60/100	60-30(30)	-	60/100-30
Vitodens 333-F B3TG 19	-	-	60/100	60-30(30)	-	60/100-30
Vitodens 333-F B3TB 26	-	-	60/100	60-20(18)	80-30(30)	60/100-14
Vitodens 300-W B3HG 11	-	-	60/100	60-30(30)	-	60/100-30
Vitodens 300-W B3HG 19	-	-	60/100	60-30(30)	-	60/100-30
Vitodens 300-W B3HG 26	-	-	60/100	60-23(21)	80-30(30)	60/100-16
Vitodens 333-F B3TG 26	-	-	60/100	60-20(18)	80-30(30)	60/100-14
Vitoladens 300-C BC3B/J3RB 19 / 23	-	-	80/125	80-30(30)	-	80/125-30
Vitoladens 300-C BC3B/J3RB 29	-	-	80/125	80-30(30)	-	80/125-30
Vitoladens 300-T VW3B 33, 40 und 50	-	-	auf Anfrage	-	-	-
Vitorondens 200-T BR2A 20	-	-	80/125	80-30(30)	-	80/125-30
Vitorondens 200-T BR2A 24	-	-	80/125	80-30(30)	-	80/125-30
Vitorondens 200-T BR2A 28	-	-	80/125	80-30(30)	-	80/125-24
Vitorondens 200-T BR2A 33	-	-	80/125	80-23(21)	100-30(30)	80/125-15
Vitorondens 200-T BR2A 40	-	-	100/150	100-30(30)	-	100/150-30
Vitorondens 200-T BR2A 50	-	-	100/150	100-30(27)	-	100/150-18



WEISHAUPT	Anschlussstück Kesselhersteller	ATEC Anschlussadapter gerade	Verbindungsleitung	Steigleitung einwandig	Außenwandmontage
raumluftabhängig					
WTC-GB 15-B	-	0130 €32	60	60-26(23)	60/100-26
WTC-GB 25-B	-	-	80	80-30(30)	80/125-30
WTC-GB 120-B	480 000 11 732	4115 €60	125	125-30(30)	125/190-30
WTC-GB 150-B	-	-	110	110-24(20)	125-30(30)
WTC-GB 210-A	480 000 11 782	6115 €75	160	160-30(30)	160/230-30
WTC-GB 250-A	480 000 11 782	6115 €75	160	160-30(30)	160/230-30
WTC-GB 300-A	480 000 11 782	6115 €75	160	160-30(23)	160/230-30
WTC-GB 470-A	-	9115 €110	250	250-30	250/315-30
WTC-GB 620-A	-	9115 €110	250	250-30	250/315-30
WTC-GW 15-B	-	-	80	80-30(30)	80/125-30
WTC-GW 25-B	-	-	80	80-30(30)	80/125-30
WTC-GW 32-B	-	-	80	80-30(30)	80/125-30
WTC-GW 45-B	480 000 05 322	-	80	80-11(7)	100-30(30)
WTC-GW 60-B	480 000 05 322	-	80	100-30(25)	-
WTC-GW 80-A	480 000 14 952	-	110	110-30(30)	110/160-30
WTC-GW 100-A	480 000 14 952	-	110	110-30(30)	110/160-30
WTC-OB 14-B / 18-B	-	-	80	80-30(30)	80/125-30
WTC-OB 25-B	-	-	80	80-30(30)	80/125-30
WTC-OB 30-B	-	-	80	80-30(24)	80/125-30
WTC-OB 35-B	-	-	80	80-26(17)	100-30(30)
WTC-OB 45-A	-	-	80	100-30(23)	100/150-30



WEISHAUPT	Anschlussstück Kesselhersteller	ATEC Anschlussadapter gerade		Verbindungs- leitung	Steigleitung einwandig		konzentrisch	Außenwandmontage	
raumluftunabhängig									
WTC-GB 15-B	-	-	-	60/100	60-22(20)	-	60/100-15	60/100-26	-
WTC-GB 25-B	-	-	-	80/125	80-30(30)	-	80/125-30	80/125-30	-
WTC-GB 120-B	480 000 11 732	4115 €60	-	125	125-30(28)	-	-	125/190-30	-
WTC-GB 150-B	-	-	-	110/160	110-8(7)	125-18(16)	125/190-14	110/160-10	125/190-30
WTC-GB 210-A	480 000 11 782	6115 €75	-	160	160-30(18)	-	-	160/230-30	-
WTC-GB 250-A	480 000 11 782	6115 €75	-	160	160-20(12)	200-30	-	160/230-19	-
WTC-GB 300-A	480 000 11 782	8107 €142	8115 €77	200	200-30	-	-	200/265-30	-
WTC-GW 15-B	-	-	-	80/125	80-30(30)	-	80/125-30	80/125-30	-
WTC-GW 25-B	-	-	-	80/125	80-30(30)	-	80/125-29	80/125-30	-
WTC-GW 32-B	-	-	-	80/125	80-30(30)	-	80/125-30	80/125-30	-
WTC-GW 45-B	480 000 05 322	-	-	80/125	100-21(17)	110-30(28)	80/125-4	80/125-7	100/150-30
WTC-GW 60-B	480 000 05 322	-	-	80/125	100-16(12)	110-29(22)	100/150-11	100/150-27	-
WTC-GW 80-A	480 000 14 952	-	-	110/160	110-28(27)	-	-	110/160-30	-
WTC-GW 100-A	480 000 14 952	-	-	110/160	110-26(25)	-	-	110/160-30	-
WTC-OB 14-B / 18-B	-	-	-	80/125	80-30(28)	-	80/125-27	80/125-30	-
WTC-OB 25-B	-	-	-	80/125	80-30(26)	-	80/125-25	80/125-30	-
WTC-OB 30-B	-	-	-	80/125	80-23(17)	100-30(30)	80/125-17	80/125-30	-
WTC-OB 35-B	-	-	-	80/125	80-17(13)	100-30(30)	100/150-30	80/125-22	100/150-30
WTC-OB 45-A	-	-	-	80/125	110-22(18)	-	110/160-14	110/160-28	-



WOLF	Anschlussstück Kesselhersteller	ATEC Anschlussadapter gerade		Verbindungs- leitung	Steigleitung einwandig		Außenwandmontage		
raumluftabhängig									
CGB-2 14/ CG+A1067+A1085J1108+A1085J1102-	-	-	-	60	60-30(30)	-	-	60/100-30	-
CGB-2 20/ CGB-2K 20/ CGS-2 20/ CGW-2 20 -	-	-	-	60	60-25(22)	80-30(30)	-	60/100-25	80/125-30
CGB-2 24/ CGB-2K 24/ CGS-2 24/ CGW-2 24 -	-	-	-	60	60-21(17)	80-30(30)	-	60/100-21	80/125-30
CGB-2 38	-	-	-	80	80-30(30)	-	-	80/125-30	-
CGB-2 55	-	-	-	80	80-17(15)	100-30(30)	-	80/125-17	100/150-30
CGB 50	-	-	-	80	80-23(20)	100-30(30)	-	80/125-23	100/150-30
CGB-2 75	-	-	-	110	110-30(30)	100-26(22)	-	100/150-30	100/150-26
CGB-2 100	-	-	-	110	110-30(30)	-	-	100/150-30	-
CSZ-2 14/300R	-	-	-	60	60-30(30)	-	-	60/100-30	-
CSZ-2 20/300R	-	-	-	60	60-25(22)	80-30(30)	-	60/100-25	80/125-30
CSZ-2 24/300R	-	-	-	60	60-21(17)	80-30(30)	-	60/100-21	80/125-30
MGK-2-130	-	4104 €118	4115 €60	125	125-30(30)	-	-	125/190-30	-
MGK-2-170	-	6115 €75	-	160	160-30(30)	-	-	160/230-30	-
MGK-2-210	-	6115 €75	-	160	160-30(30)	-	-	160/230-30	-
MGK-2-250	-	6115 €75	-	160	160-30(30)	-	-	160/230-30	-
MGK-2-300	-	6103 €155	6115 €75	160	160-23(22)	200-30	-	160/230-23	200/265-30
MGK-2-390	-	8102 €155	8115 €77	200	200-30	-	-	200/265-30	-
MGK-2-470	-	8102 €155	8115 €77	200	200-30	-	-	200/265-30	-
MGK-2-550	-	8102 €155	8115 €77	200	200-21	250-30	-	200/265-21	250/315-30
MGK-2-630	-	8102 €155	8115 €77	200	200-13	250-30	-	200/265-13	250/315-30
MGK-2-800	-	9115 €110	-	250	250-30	-	-	250/315-30	-
MGK-2-1000	-	9115 €110	-	250	250-30	-	-	250/315-30	-
TGB-2-20	-	-	-	80	80-30(30)	-	-	80/125-30	-
TGB-2-30	-	-	-	80	80-30(30)	-	-	80/125-30	-
TGB-2-40	-	-	-	80	80-30(28)	-	-	80/125-30	-
TOB-TS/TR 18	-	-	-	80	80-30(30)	-	-	80/125-30	-
COB-2 15/ COB-2-15 TS/TR	-	-	-	80	60-21(20)	80-30(30)	-	60/100-21	80/125-30
COB-2 20/ COB-2 20 TS/TR	-	-	-	80	80-30(30)	-	-	80/125-30	-
COB-2 29/ COB-2 29 TS/TR	-	-	-	80	80-30(30)	-	-	80/125-30	-
COB-2 40	-	2232 €51	-	100	100-30(30)	-	-	100/150-30	-

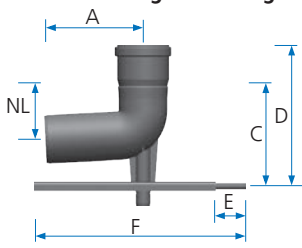
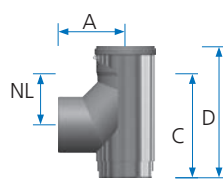
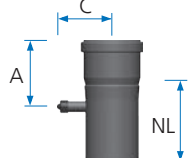
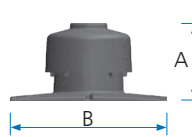
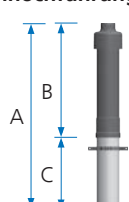
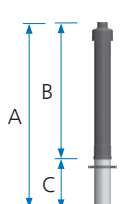
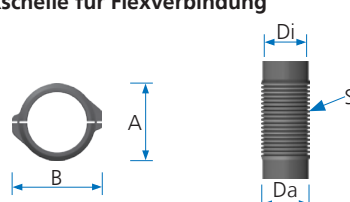
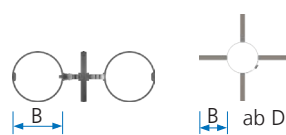

WOLF	Anschlussstück Kesselhersteller	ATEC Anschlussadapter gerade		Verbindungs- leitung	Steigleitung einwandig		konzentrisch	Außenwandmontage	
raumluftunabhängig									
CGB-2 14/ CGS-2 14/ CGW-2 14	-	-	-	60/100	60-30(30)	-	60/100-29	60/100-30	-
CGB-2 20/ CGB-2K 20/ CGS-2 20/ CGW-2 20	-	-	-	60/100	60-19(17)	80-30(30)	60/100-14	60/100-25	80/125-30
CGB-2 24/ CGB-2K 24/ CGS-2 24/ CGW-2 24	-	-	-	60/100	60-16(14)	80-30(30)	60/100-12	60/100-20	80/125-30
CGB-2 38	-	-	-	80/125	80-28(27)	-	80/125-18	80/125-30	-
CGB-2 55	-	-	-	80/125	80-11(10)	100-30(30)	80/125-6	80/125-11	100/150-30
CGB 50	-	-	-	80/125	80-12(11)	100-30(30)	80/125-9	80/125-22	100/150-30
CGB-2 75	-	-	-	110/160	110-18(17)	-	110/160-10	110/160-30	100/150-25
CGB-2 100	-	-	-	110/160	110-20(19)	125-30(30)	110/160-11	110/160-30	-
CSZ-2 14/300R	-	-	-	60/100	60-30(30)	-	60/100-29	60/100-30	-
CSZ-2 20/300R	-	-	-	60/100	60-19(17)	80-30(30)	60/100-14	60/100-25	80/125-30
CSZ-2 24/300R	-	-	-	80/125	60-16(14)	80-30(30)	60/100-12	60/100-20	80/125-30
TGB-2-20	-	-	-	80/125	80-30(30)	-	-	80/125-30	-
TGB-2-30	-	-	-	80/125	80-30(30)	-	-	80/125-30	-
TGB-2-40	-	-	-	80/125	80-17(15)	100-30(30)	-	80/125-30	-
TOB-TS/TR 18	-	-	-	80/125	80-30(30)	-	80/125-20	80/125-30	-
COB-2 15/ COB-2-15 TS/TR	-	-	-	80/125	60-18(16)	80-30(30)	60/100-13	60/100-22	80/125-30
COB-2 20/ COB-2 20 TS/TR	-	-	-	80/125	80-30(30)	-	80/125-27	80/125-30	-
COB-2 29/ COB-2 29 TS/TR	-	-	-	80/125	80-28(26)	-	80/125-20	80/125-30	-
COB-2 40	-	2221 €123	-	100/150	100-30(30)	-	100/150-30	100/150-30	-

Alle Maße in mm		Muffe Ø	DN	60	80	100	110	125	160	200	250	
		Durchmesser außen	D	60	80	100	110	125	160	200	250	
		Durchmesser innen	Di	56	76	96	105	119	153	193	242	
		Muffenaußenmaß	MA	75	94	115	128	146	184	220	274	
Schachteinführung mit Auflager												
		A	98	161	171	123	134	180				
		NL	44	95	105	67	76	93				
		C	100	172	192	160	186	208				
		D	160	232	252	220	255	307				
		E	50	50	50	50	70	70				
		F	350	350	350	350	420	420				
Schachteinführungsstütze												
		A								230	230	
		NL								196	163	
		C								381	375	
		D								477	475	
Messelement/Kesselanschluss												
		A	98	100	98	98	120	120	140	150		
		NL	122	124	122	122	257	256	204	200		
		C	72	83	96	103	109	127	147	172		
Mündungs-Set Kunststoff												
		A	177	177	177	177	193	193	193	221		
		B	360	360	360	360	400	400	440	500		
Dachhochführung, 650 mm												
		A	1120	1040								
		B	614	636								
		C	506	404								
Dachhochführung, 1100 mm												
		A		1490	1420	1500						
		B		1086	931	990						
		C		404	489	510						
Fixschelle für Flexverbindung												
		A	82	102	121	134	152	188				
		B	100	118	138	153	172	207				
		Di	53	74	94	102	118	154				
		Da	64	85	105	113	131	165				
		S	1,1	1,1	1,1	1,1	1,3	1,3				
		S= Wandstärke Flexrohr in mm										
Abstandhalter												
		B*	105	105	105	105	105	105	180	180		
		* Die Abstandhalter zentrieren die Abgasleitungsabschnitte ab dem Mindestabstand von 20 mm und sind ggf. anzupassen.										

Alle Maße in mm	Muffe Ø	DN	60	80	100	110	125	160	200	250
	Durchmesser außen	D	60	80	100	110	125	160	200	250
	Durchmesser innen	Di	56	76	96	105	119	153	193	242
	Muffenaußenmaß	MA	75	94	115	128	146	184	220	274
87°-Kontroll-Bogen		E	97	161	172	139	134	180	234	230
		M	36	87	97	78	69	84	188	134
		NL	99	166	177	143	138	184	243	237
Kontroll-Rohr		NL	147	190	210	230	215	261	366	434
		K	104	132	142	147	149	190	209	265
30°-Bogen		E	79	125	107	85	90	125	273	144
		M	17	50	26	23	25	28	82	48
		NLV	177	323	245	199	212	285	662	355
		V	47	86	65	53	56	76	177	95
		NL	94	168	130	105	112	149	344	185
45°-Bogen		E	81	125	125	94	99	137	283	162
		M	22	50	50	32	35	40	78	66
		NLV	174	296	296	213	226	302	616	387
		V	71	121	121	87	92	125	254	160
		NL	96	160	160	117	124	165	338	208
87°-Bogen		E	101	162	172	139	134	180	230	230
		M	39	87	96	79	69	84	189	134
		NLV	147	261	282	229	213	278	442	383
		V	138	244	264	216	199	263	420	362
		NL	103	166	177	143	138	184	240	237
Kondensatablauf, mit Siphon		NL	137	137	137	137	161	131	199	395
		K	98	98	97	97	110	111	173	331

Stark in Qualität und Service

Im ständigen Dialog mit erfahrenen Partnern nutzen wir die Chance und entwickeln Ideen und Produkte, die den Kunden einen zusätzlichen Nutzen bieten.

Service - egal ob in der Beratung oder Berechnung - wird bei uns groß geschrieben.

- Planungs- und Montagehinweise für viele Bereiche und Einzelprodukte
- Detailinfos zu den Artikeln - einfach Artikelnummer unter „Produkte“ eingeben
- Maßzeichnungen für zahlreiche Produkte und Artikel. Es werden immer mehr!
- Planungsformular zur Berechnung des Querschnitts und zur PDF-Formulare zur Planung von Schalldämpfern und Wärmepumpen
- Seminarkalender: Unsere Weiterbildungsangebote mit vielen Tipps und Tricks



atec-abgas.de/produkte/



atec-abgas.de/planung/



seminare.atec-abgas.de

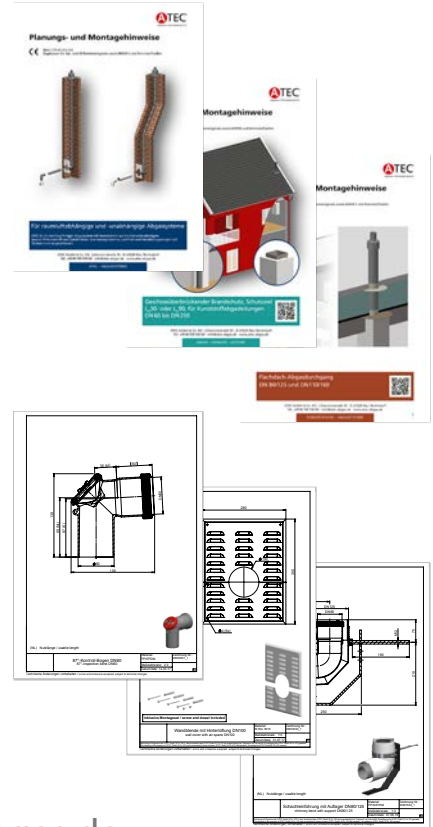

Entdecken Sie unsere Webseite unter www.atec-abgas.de

Dort gibt es auch viele weitere handwerkerfreundliche Lösungen:

