

Project

Keramik für öffentliche und gewerbliche Räume

Neue Produkte
für Pools + Spas

Lieferprogramm

2022



Die Wohnkeramischen Serien finden Sie ab sofort im Lieferprogramm Living.

Living

	Alcina	Lunar
NEU	Aruba	Mandalay
	Basis 1	Mando
	Cedra	Modern White
	Como	Oak
	Concrete	Pizarro
	Evalia	Remix
	Focus Royal	Sierra
NEU	Jasba-CLARA	Sky
	Jasba-PATTERN	NEU Solid Rock
	Jasba-RONDA	Soul
	Jasba-SENJA PURE	Stories
	Jasba-VILLAGE	Timeless
	Jasba-NIVELLA	Trevi
	Kiano	Urban Cotto
	La Casa	Walden
	Like	

Project

Einleitung	4 – 19
Produktfinder	20 – 29
Amano	32 – 35
Area Pro	36 – 61
NEU Ascona	62 – 73
Basic Stone	74 – 77
Basis	78 – 87
Basis 1	81 – 82
Basis 1+	83
Basis 2	84
Basis 3	85 – 86
Basis 4	87
Basis Pro	88 – 93
Blindenleitsysteme	94 – 99
Chroma	100 – 107
Chroma non-slip	108 – 117
Chroma unglasiert	118 – 125
Craft	126 – 133
NEU Craft Extended	134 – 137
District	138 – 141
Eladuct + Keraion ELA	142 – 145
Emotion	146 – 155
Emotion Grip	156 – 161
Ferrum	162 – 165
Fresh	166 – 181
Karl	182 – 187
Kauri	188 – 193
Keraion-OP-Spezialglasuren	194 – 197
Loop	198 – 207
NEU Marble & More	208 – 211
Naturkeramik	212 – 219
New Market	220 – 225
Nova	226 – 233
Plural	234 – 251
Plural non-slip	252 – 259
Plural unglasiert	260 – 265
Plural Kids	266 – 271
Quarzit	272 – 279
Savona	280 – 285
Streetlife	286 – 291
Surf	292 – 299
Trias	300 – 305
Unique	306 – 311
Valley	312 – 317
Xeno	318 – 321

Pool + Spa

Einleitung	324 – 329
Chroma	330 – 337
Chroma non-slip	338 – 345
Chroma unglasiert	346 – 351
Beckenkopfsysteme – Systemlösungen im Schwimmbadbau	352 – 409
Übersicht	354 – 357
Finnland	358 – 363
Finnland II	364 – 369
Wiesbaden hochliegend	370 – 373
Wiesbaden Silent	374 – 375
Wiesbaden mit Mosaikausklinkung	376 – 377
Wiesbaden Stil	378 – 381
Wiesbaden tiefliegend	382 – 385
Wiesbaden Therapiebecken	386 – 389
Bamberg	390 – 393
St. Moritz	394 – 397
Berlin	398 – 401
Zürich	402 – 405
Skimmer	406 – 409
Beckenrandsteine	410 – 413
Hohlkehlen, Sockel, Radialleisten	414 – 421
Rillenplatten	422 – 427
Spezialplatten	428 – 435
Schwimmbadzubehör – Abläufe und Abdeckroste	436 – 437
Keramische Rinnenabdeckung 2.0	438 – 441
Abdeckroste	442 – 443
Abläufe	444 – 445

Index/Technische Informationen

Artikelnummern	448 – 459
Formate	460 – 461
Formatnummern	462 – 463
Zuordnung NCS/RAL	464 – 465
Hellbezugswerte	
Leuchtdichtekontrast	466 – 467
Technische Informationen	468 – 485
Vertriebskontakte D-A-CH	486 – 487
Erläuterungen	489

Wir verstehen. Seit 1755.



Verlässlich

Wir kennen uns aus mit Fliesen. Seit 1755 arbeiten wir mit Ton und haben ein umfassendes Verständnis für unser Material und für die Herstellung von Steinzeug, Feinsteinzeug und Steingut von höchster Qualität. In unseren vier deutschen Produktionsstätten verfeinern wir ständig unsere Rezepte zum Mischen von Ton, Feldspat, Schamotte, Kaolin und Wasser. Als natürliches Material, das in sorgfältig überwachten Brennprozessen von plastisch nach fest übergeht, bietet Ton unendliche Möglichkeiten der Herstellung von keramischen Produkten, die dazu beitragen, Architektur dauerhaft, nachhaltig und schön zu machen.



Vielseitig

Unsere Produkte finden weit und breit Anwendung. Innen und Außen. Von Privatwohnungen bis hin zu Museen. Von Hotels bis zu Krankenhäusern. Von Restaurants bis zu Büros. Von Geschäften bis zu Schwimmbädern. Von Badezimmerböden bis zu Gebäudefassaden. Wir bieten Boden-, Wand- und Fassadenfliesen für jeden Verwendungszweck an. Und wir stellen alle Arten von Spezialelementen her, um nahezu jede spezifische Anforderung zu erfüllen, sei es ein Formteil für ein Schwimmbad oder ein integriertes Leitsystem für sehbehinderte Menschen. Unsere Fliesen finden sich überall, weltweit.

Kooperativ

Ganz gleich, wie gut unsere Produkte sind, wir glauben, dass nur ihre Anwendung ihre Qualitäten zur Geltung bringt. Deshalb schätzen wir Zusammenarbeit und freuen uns, unser Wissen zu teilen, um die beste Lösung für jedes Ihrer Architekturprojekte zu finden. Dort wo unsere Standardprodukte an ihre Grenzen gelangen, entwickeln wir maßgeschneiderte Lösungen. Sonderfertigungen sind unsere Spezialität. Wir haben die Expertise und die Erfahrung, um Architekten von der Ausschreibung bis zur Fertigstellung von Projekten zu unterstützen. Sagen Sie uns, wie wir Ihnen helfen können. Sagen Sie uns, wenn Sie hören möchten, was wir wissen.

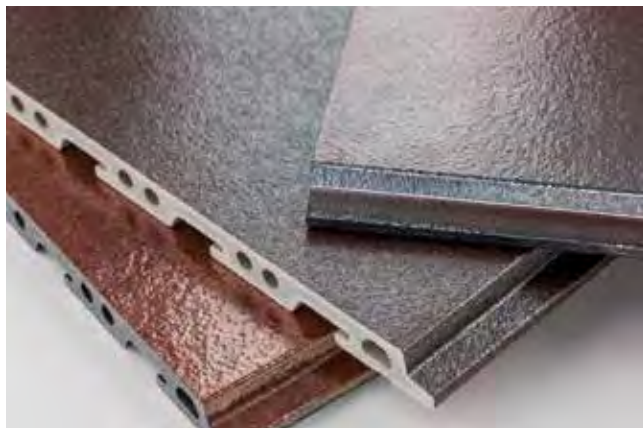

Innovativ

Wir wissen, wie man großartige Fliesen herstellt. Dennoch arbeiten wir ununterbrochen daran, sie noch besser zu machen. Handwerkliches Können und neue Technologien verbinden sich bei der Schaffung innovativer rutschhemmender Oberflächen für Nassbereiche und der Entwicklung neuer und einfacher Verfahren zur Verarbeitung von Keramik, wie z. B. DryTile, das eine Verlegung ohne Kleber ermöglicht. Wir investieren in Gesundheit und Hygiene, wie unsere nachhaltige Hytect-Technologie zeigt, die in fast jedem von uns hergestellten Produkt Anwendung findet. Neben der Entwicklung von Innovationen in allen Bereichen sind wir stolz darauf, maßgeschneiderte neue Lösungen anzubieten und Architekten bei der Umsetzung ihrer besten Ideen zu unterstützen.



Nachhaltig

Die Anforderungen an das Bauen wachsen kontinuierlich. Bauherren, Planer und Nutzer stellen neue Ansprüche, die auch die zukünftigen Entwicklungen stärker berücksichtigen. Energieeffizienz, Ressourcenschonung und Klimawandel sind hier die Stichworte, die entscheidenden Einfluss nehmen. Agrob Buchtal ist sich der Verantwortung zu nachhaltigem Bauen bewusst und unterstützt nachhaltiges Bauen nicht nur ideell über die Mitgliedschaft in der Deutschen Gesellschaft für Nachhaltiges Bauen (DGNB). Früh haben wir uns im Rahmen einer Umweltproduktdeklaration nach ISO14025 auf Branchenebene dazu entschlossen, alle für den Planungsprozess eines nachhaltigen Gebäudes wichtigen ökologischen Produktdaten transparent zu machen. Ob ein Gebäude unter Nachhaltigkeitsaspekten zu überzeugen vermag, lässt sich über Zertifizierungssysteme messbar machen. Hierzu müssen spezifische Produktinformationen zur Verfügung stehen und dokumentiert werden.

Wir sind vor Ort.

Sieben Standorte und weltweit verfügbar.

DSA Deutsche Steinzeug America, Inc





Alfter-Witterschlick

Ötzingen

Sinzig

Schwarzenfeld

Deutsche Steinzeug Schweiz AG

Deutsche Steinzeug France S.A.R.L

Modulare Farbsysteme

Modulare Farbsysteme sind für komplexe Anforderungen in allen Bereichen der Architekturkeramik konzipiert. Die neue Serie Area Pro ist mit ihrer umfangreichen Produktpalette an Fliesen und Zubehör ein echter Allrounder. Sie verbindet anspruchsvolles Design mit hoher Funktionalität und bietet so durchdachte Lösungen für die unterschiedlichsten Anwendungsbereiche. Als perfekte Synthese von Funktion und Ästhetik unterstützt Emotion durchgängige Raumkonzepte für funktionale und repräsentative Bereiche. ChromaPlural fördert mit 50 aufeinander abgestimmten Farbtönen und 24 Formaten die variationsreiche, raumübergreifende Gestaltung von Wand- und Bodenflächen. Fresh und Loop bieten besonders spannende Farben und Formate im Bereich Mosaik.



Area Pro: Natürlich intuitiv

Gutes Design vermittelt immer einen intuitiven Zugang zu dessen Nutzung – so geht auch das Gestalten mit Area Pro leicht von der Hand. Die breite Produktpalette regt mit Erdtönen und einer angenehmen Haptik unmittelbar zu Ideen für ihren Einsatz an. Die von feinkörnigem, geschichtetem Kalkstein inspirierte Serie fügt sich mühelos ein und hebt sich zugleich ab. Das macht die Fliesen und ihr Zubehör zu perfekten Allroundern in fast jedem Ambiente. Die neue Serie strahlt bereits jetzt das Potenzial aus, ein Klassiker zu werden.

Chroma: Das Farbkonzept: Mischen und kombinieren

Wenn es um Farbgestaltung im Poolbereich geht, ist meist Blau die Farbe der Wahl. Chroma bietet darüber hinaus aber auch warme und neutrale Farbtöne aus dem von der Natur inspirierten Farbsystem – für variationsreiche Klassiker, individuelle Akzente und ganzheitliche Optik. Insgesamt 35 verschiedene Farben gehören zum Standardlieferprogramm der Pool-Serie.

Die Farbskalen sind in sechs Gruppen unterteilt: Warme, erdige, kühle, frische und sonnige Farbtöne bewegen sich um eine Gruppe aus gedämpften, neutralen Grautönen. Jede Gruppe enthält Farben, die sich leicht kombinieren lassen, sowohl innerhalb der Gruppe als auch mit anderen Gruppen. So kann stets eine konsistente und einheitliche Gestaltung geschaffen werden.



Plural: Farbenfroh und flexibel

Die speziell für Plural entwickelte Farbpalette umfasst 50 aufeinander abgestimmte Farben. Ob glasiert oder unglasiert, Steingut, Steinzeug oder Feinsteinzeug – die schmale 3 mm-Fuge ist bei Plural ebenso Standard wie die schadstoffabbauende Veredelung Hytect und die Ausführung in verschiedenen Trittsicherheiten. Plural ist so vielseitig im Innen- und Außenbereich einsetzbar: von der Fassade bis zum Boden, von der U-Bahnstation bis zur Wellnesslandschaft.



Emotion: Modular und zeitlos

Mit aufeinander abgestimmten Farben und Oberflächen, rutschhemmenden Fliesen von R9 bis R12V4 und einer Formatvielfalt von Großformaten bis hin zu funktionalen Hytect-veredelten Mosaiken (in R10/B) bieten die Fliesen der Serie Emotion Architekten viel Freiraum. Emotion sorgt vor allem dort für eine gute Gestaltung, wo es um den Übergang zwischen Bereichen mit unterschiedlichen Anforderungen an die Rutschhemmung geht. Front cooking im Blickkontakt zu den Restaurantgästen wird dadurch ebenso möglich wie das reibungslose und ästhetisch gelungene Nebeneinander von Werkstatt und Showroom in einem Autohaus.

Fresh: Frisch und modern

Fresh bietet eine stimmige Palette an modernen, frischen Farben in den beliebten Mosaikformaten 2,5 x 2,5 cm und 5 x 5 cm, mit denen individuelle, aber zugleich auch unkompliziert zu realisierende Gestaltungen möglich werden. Besonders praktisch ist dabei: Zu den Fliesen gibt es farblich passende rutschhemmende Mosaiksteine in R10/B.

Farbverläufe akzentuieren ausgewählte Bereiche, lockern Gesamtbilder auf und inszenieren kunstvolle Wechselspiele mit homogenen Fliesenflächen. Als Verkleidung einzelner Elemente wie Säulen, Trennwände oder Barthecken bringen sie einen eigenen Rhythmus in den Raum.



Loop: Fein und rund

Das Geheimnis der Tiefe, Leuchtkraft und Beständigkeit der Farben ist die Glasur. Bis zu zehn Schichten werden auf das Steinzeug aufgetragen und abriebsicher eingebrannt. Die Glasuren erarbeiten wir selbst – mit ausgesuchten Rohstoffen. So entstehen Mosaiksteine von strahlender, dauerhafter Schönheit.

LOOP bietet ein breites Spektrum an intensiven und gedeckten Farbabstufungen im Blau- und Grünbereich, kräftige Gelb-, Orange- und Rotvarianten, Grau- und Braunnuancen bis hin zu Tiefschwarz. Zarte Transparenz für Leichtigkeit und Zeitlosigkeit, leuchtende Sättigung für Akzent und Ausdruck.

Innovativ. Hytect – Die Luft ist rein

Die Hytect-Technologie wird bei hohen Temperaturen sicher in die Oberfläche der Keramik eingebrannt. Fällt Licht auf die so veredelten Fliesen, wird durch Photokatalyse Aktivsauerstoff freigesetzt. So entsteht die Wirkung gegen Bakterien und Schimmel. Gleichzeitig neutralisieren Hytect-Fliesen auf natürliche Weise Luftschadstoffe.

Und weil sie außerdem hydrophil sind, haften Schmutz und Fett kaum an ihnen. All diese Effekte wirken unvermindert über die gesamte Nutzungsdauer der Fliesen. Und Dank einer großen Bandbreite an Produkten ist Hytect-Keramik in verschiedensten Bereichen einsetzbar. Unsere Produkte, die mit unserer Hytect-Technologie veredelt sind, sind mit dem Hytect-Logo gekennzeichnet.

Die Wirkweisen

Extrem
reinigungs-
freundlich

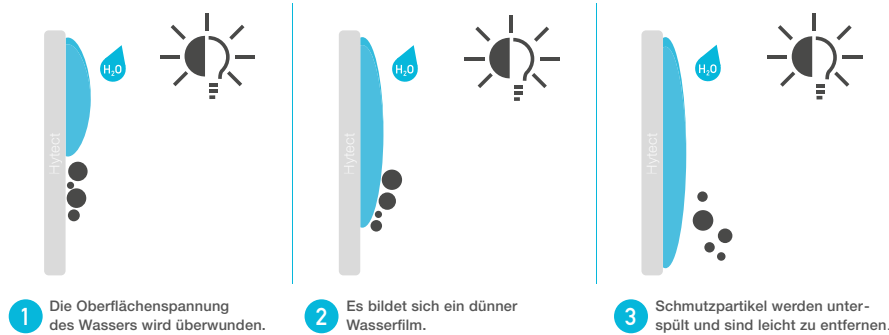

Effektiv gegen
Schimmel &
Bakterien

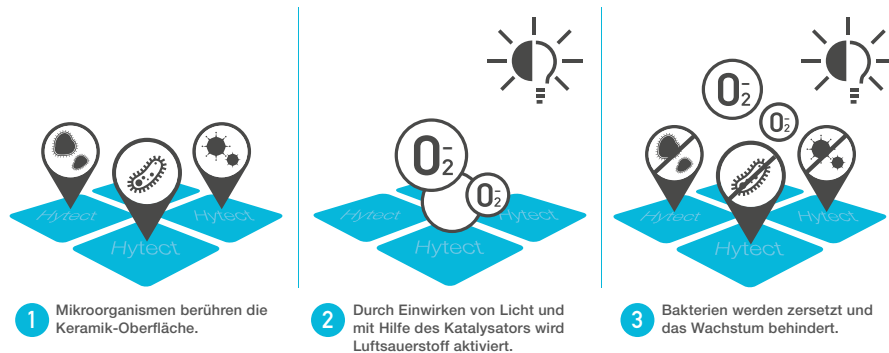

Aktiver
Abbau von Luft-
schadstoffen

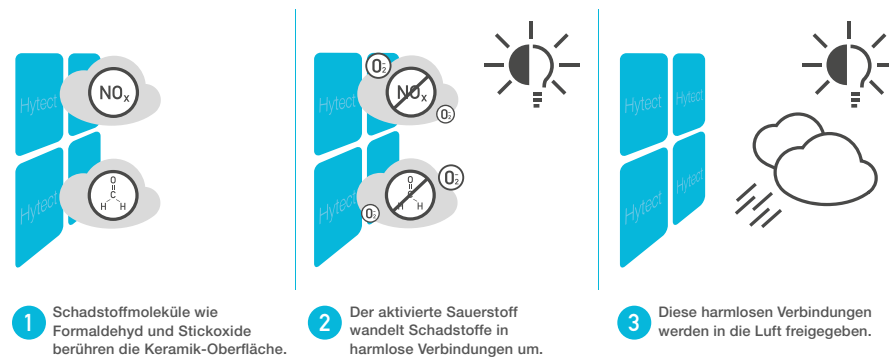

Zum Hytect-Film:



Weitere Informationen:
www.hytect.com

Rutschhemmende Fliesen für alle Einsatzbereiche.

Stürze durch Ausrutschen, Stolpern/Umknicken oder Fehltreten sind in den meisten Betrieben und Einrichtungen Unfallschwerpunkt Nr. 1. Rutschhemmende Fliesen, markiert durch das Gütesiegel „GRIP“, zählen zu unseren Kernkompetenzen. Seit der Markteinführung der ersten rutschhemmenden Fliesen in den 1930er Jahren wurde diese Innovation von uns durch intensive Forschung ständig weiterentwickelt.

Zu den Ergebnissen zählen renommierte Preise für vorbildlich gestaltete Oberflächen, funktionelle Fortschritte wie geräuscharmes und rüttelfreies Befahren sowie mikrorauhe Spezialglasuren für den Barfußbereich in Schwimmbädern. Die Qualität unserer rutschhemmenden Fliesen wird durch permanente Kontrollen der Werkslabore gewährleistet und durch externe Institute sowie die Teilnahme an Ringversuchen mit akkreditierten Prüflabors regelmäßig neutral überwacht.

Neueste Innovation bei rutschhemmenden Fliesen ist die R12V4

In Zusammenarbeit mit dem deutschen Designer Sebastian Herkner wurde eine spezielle rutschhemmende Oberfläche für Area Pro entwickelt. Sebastian Herkner war auf der Suche nach einem Muster, das spontan wirkt und dennoch eine gewisse Logik aufweist. So kam er zu den sich wiederholenden, trapezförmigen Rechtecken und dem Muster, das sich in alle vier Richtungen fortsetzen lässt. Area Pro ist mit diversen rutschhemmenden Oberflächen erhältlich, darunter Grid, mit einer Rutschhemmung von R12V4. Keine der rutschhemmenden Oberflächen beeinträchtigt die Ästhetik der Fliesen. Sie sind auch für großformatige Fliesen verfügbar, die aufgrund ihrer Eigenschaften auch in Großküchen verwendet werden dürfen.



Designer Sebastian Herkner entwickelt die rutschhemmende Oberfläche „Grid“.



Funktionalität und Schönheit vereint:
Die Oberfläche R12V4 der Serie Area Pro.



Das Design von Grid.

Individualfertigung für spezielle Anforderungen.

Mehr als der Standard

Kreative Architekten und Planer brauchen grenzenlose gestalterische Freiräume, um ihre Ideen angemessen verwirklichen zu können.



Sonderformate

werden aus nahezu 20.000 Glasur Rezepten in jedem gewünschten Ton individuell ausgewählt oder neu zusammengesetzt. Das gilt auch für Corporate Colors, die dem CD des jeweiligen Unternehmens entsprechen.



Wasserstrahltechnik

erlaubt den präzisen Schnitt von keramischen Fliesen und Platten in freien, auch geschwungenen Formen, die nach gestalterischen Vorgaben zusammengesetzt werden können.



Sonderfarben

sind bei ästhetisch anspruchsvollen Neubauten ebenso gefragt wie bei der Sanierung historischer Bausubstanz und werden exakt nach Architekten-Vorgaben gefertigt.

Architektenservice

Effiziente Unterstützung seit sechs Jahrzehnten.

Bei Agrob Buchtal gehören hochwertige Produkte und kompetente Dienstleistungen zusammen. So können Planer und Architekten, die unsere Produkte einsetzen, im Rahmen partnerschaftlicher Zusammenarbeit den seit 1952 bewährten Architektenservice nutzen.

Ein engagiertes Team qualifizierter Techniker, Ingenieure, Architekten, Designer und Farbexperten schafft die Voraussetzungen für eine schnelle, reibungslose Realisation individueller Konzepte. Und weil diese Experten neben ihrer Funktion als Fachberater auch zahlreiche Routineaufgaben übernehmen, können sich Kunden von Agrob Buchtal ganz auf die Umsetzung ihrer kreativen Ideen konzentrieren. Zum Leistungsspektrum zählen Verlegepläne, Mengenermittlungen, Leistungsverzeichnisse, Ausschreibungstexte oder die objektspezifische anwendungstechnische Beratung. Auf Wunsch steht auch ein Ansprechpartner vor Ort zur Verfügung.



Wir entwickeln Produktlösungen für alle Anwendungsbereiche



Retail

Retail-Konzepte benötigen hochwertige, authentische Materialien, die robust sind und starken Belastungen standhalten wie zum Beispiel unsere überstarken Fliesen. Oder spezielle Produktlösungen wie die mit Kork beschichtete Bodenfliese DryTile, die trocken verlegt wird. Das spart enorm viel Zeit und ist somit ein wirtschaftlicher Vorteil bei Neubau oder Sanierung.

DryTile – As fast as your business



Überstarke Fliesen

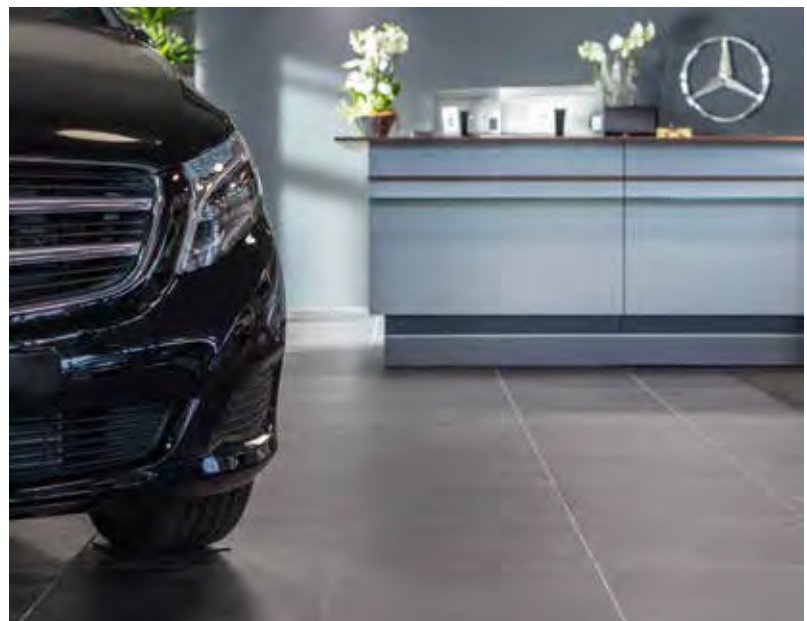



Hotel + Gastronomie

Hotels sind Zuhause auf Zeit. Eine rundum gelungene Innenarchitektur trägt dazu bei, dass Gäste sich wohlfühlen. Gefragt sind authentische Materialien, die Atmosphäre schaffen und den speziellen Reiz des Ortes herausstellen. Fliesen sind in der Architektur seit Jahrhunderten beliebtes und vielseitiges Gestaltungsmittel. Qualitativ hochwertige Keramik ist belastbar, verschleißarm, farbecht, leicht zu reinigen und somit wirtschaftlich.

Surf



Mosaik für den Wellnessbereich





Gesundheit + Pflege

In Gesundheits- und Pflegeeinrichtungen steht das Wohl von Patienten an erster Stelle – ob in Patientenzimmern, OP-Bereichen, Behandlungsräumen, Großküche, Laboren oder Therapiebädern. Die Standards an Hygiene, Sauberkeit und Barrierefreiheit sind sehr hoch. Gleichzeitig wünschen Betreiber eine anspruchsvolle Innenarchitektur mit beruhigender und freundlicher Atmosphäre. Diese wirkt sich positiv auf das Wohlbefinden der Patienten aus und begünstigt somit die Genesung. Auch für besondere Anforderungen in Gesundheitseinrichtungen bieten wir Sonderprodukte: Keramik mit Spezialglasur absorbiert störende Reflexionen – extra konzipiert für OP-Räume und Bereiche, wo Lasertechnik zum Einsatz kommt. Sonderlösungen für Therapiebecken verbinden Funktionalität mit schönem Design.

Therapiebereiche



Keramik gegen Keime





Bildung

Schulen, Kindergärten und Universitäten sind Orte der Bildung genau wie politische, künstlerische oder musikalische Einrichtungen. Ein ansprechend gestaltetes Umfeld steigert die Lernbereitschaft und wirkt inspirierend. Und wenn Menschen sich wohlfühlen, kommen sie gerne wieder. Farbe ist ein wichtiges Element, um Räumen Atmosphäre und Ausdruck zu verleihen. Im Zusammenspiel mit Material und Textur entsteht zum Beispiel in Kitas oder Grundschulen ein positives, aktivierendes Umfeld. Farbtiefe, Brillanz und Ausdruckskraft von Keramik sind von Dauer. Auch den Beanspruchungen durch ständigen Publikumsverkehr trotz qualitativ hochwertige Keramik über Jahrzehnte.

Modulare Farbsysteme



Blindenleitsystem

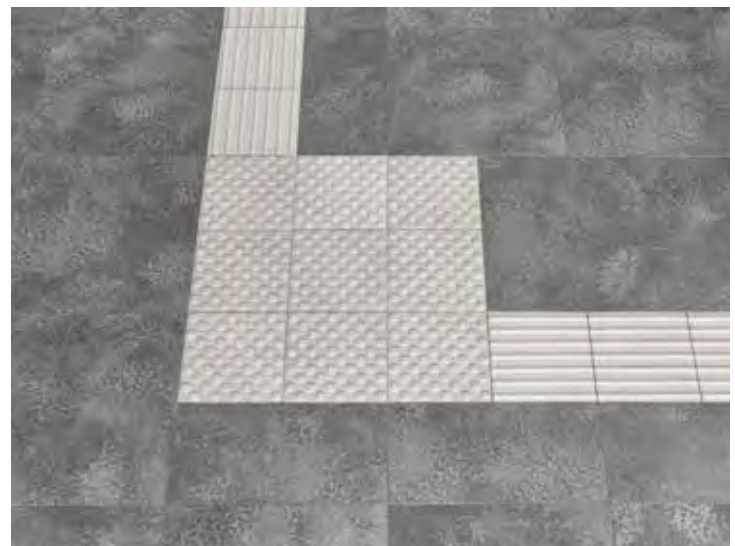



Industrie + Infrastruktur

Die Planung und Ausführung von Infrastrukturbauten sind herausfordernd. Bauwerke wie Bahnhöfe, U-Bahnstationen, Tunnel oder Flughäfen sollen multifunktional sein, ansprechend aussehen und zum Stadtbild passen. In diesen Bereichen begegnen sich täglich tausende Menschen. Hochfrequentierte Bereiche erfordern rutschhemmende, belastbare und wartungsarme Baustoffe. Aber genauso reinigungsfreundliche Oberflächen. Hier spielt die Hytect-Fliese ihre Vorteile aus. Die patentierte Oberflächenveredlung aktiviert einen natürlichen Prozess, der die Luft reinigt und Stickoxide sowie Gerüche neutralisiert. Ebenso sind unerwünschte Schmierereien wie Graffitis nachweislich leicht entfernbar. Spezialprodukte wie Blindenleitsysteme geben Orientierung und ermöglichen eine barrierefreie Konzeption.

Fassade



Die Fassade ist mehr als eine schützende Außenhülle. Sie verhüllt das Gebäude wie ein Kleid. Ihre Gestaltung prägt nicht nur den Baukörper selbst, sondern wirkt auch oft weithin sichtbar auf das urbane Umfeld ein. Als Baustoff, der sich schon seit Jahrtausenden bewährt hat, bringt Keramik ideale Eigenschaften auch für die Fassade mit. Sie ist nicht brennbar, chemikalienresistent, lichtecht, druck-, stoß- und kratzfest. Außerdem ist sie baubiologisch unbedenklich. Sie punktet mit ihrer unbegrenzten Lebensdauer und kann komplett recycelt werden. Die Möglichkeiten der Gestaltung ergeben sich durch die Kombination von Farbe, Oberfläche, Format und Form in allen denkbaren Ausführungen: kraftvolle, satte Farben oder monochrome zurückhaltende. Glasierte, unglasierte, matte oder glänzende Oberflächen. Großformatige Platten, schmale Riegelformate oder Mosaik für organische Formen. Dreidimensionale Formen, Baguettes oder Rohre.



Pool + Spa

Die Konzeption zeitgemäßer Bäderarchitektur ist komplex und muss hohen Anforderungen gerecht werden. Und das nicht nur in der Gestaltung: Ob Sport-, Freizeit- und Erlebnisbäder, Therapiebäder, Privat- und Hotelbäder, Sport- und Wettkampfbecken – sie alle müssen sicher sein, leicht zu reinigen und günstig in der Unterhaltung. Fliesen erfüllen diese funktionalen Ansprüche: Zum Beispiel durch rutschhemmende Spezialoberflächen, die selbst bei Nässe sicheren Halt bieten. Für eine konsistente Gestaltung vom Becken und Beckenumgang bis hin zu allen angrenzenden Bereichen wie Duschen, Saunen, Umkleiden oder Restaurants sind modular kombinierbare Fliesen und Formteile wichtig.

Durchgängiges Design in allen Poolbereichen



Farbverläufe



Bildverlegung



Jeder einzelne Mosaikstein wird von Hand platziert und anschließend auf Netz verklebt.

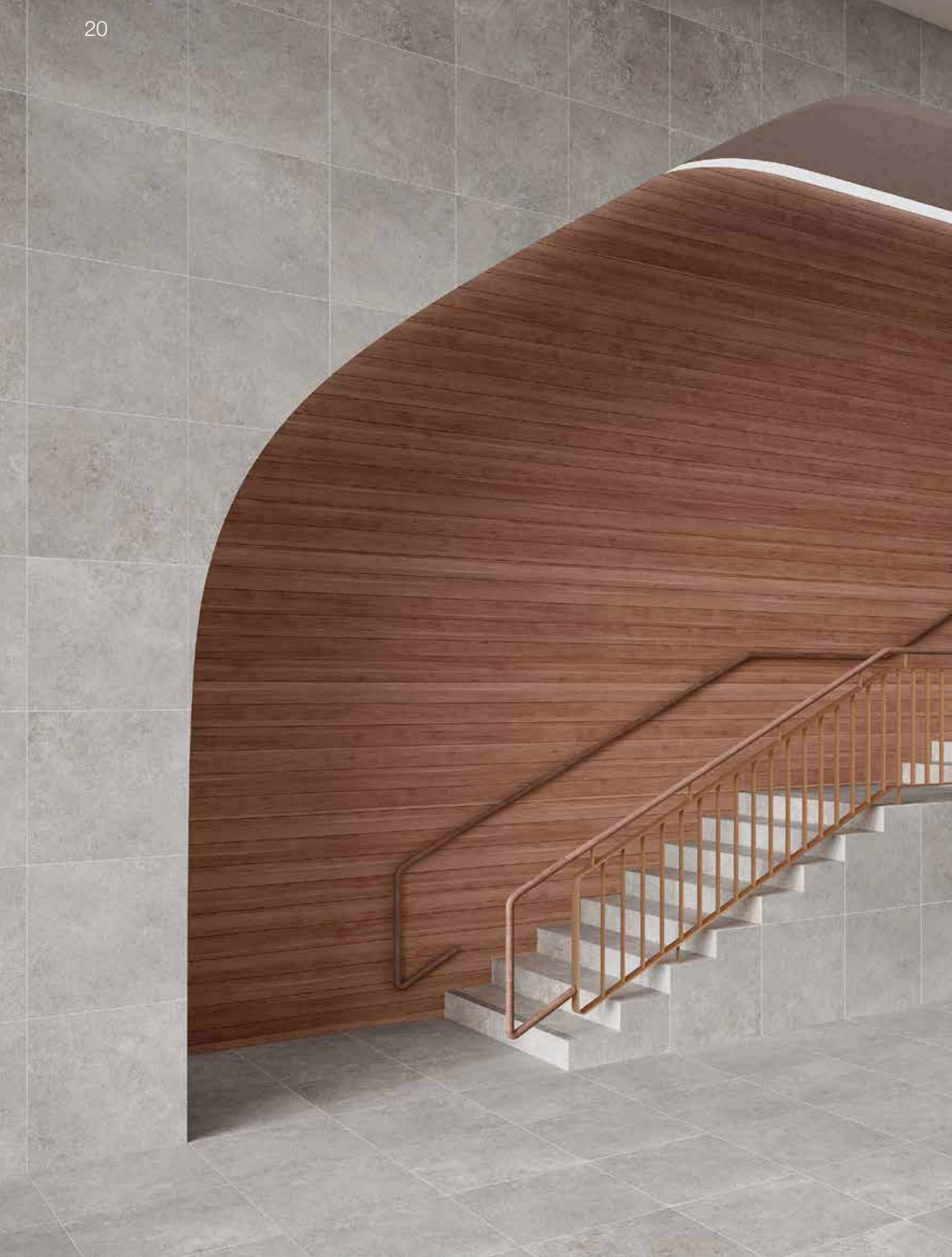



Product Finder

Pool + Spa

Serie	Anzahl	Produktkategorie															Einsatz						
		Ab Seite	Bodenfliesen	Bodenfliesen überstark	Dekoration	Duschböden	Mosaik	Sockel	Terrassenplatten	Treppenfliesen	Wandfliesen	Waschtische	Flachrinnen/Rinnenschalen/-steine	Keramischer Abdeckrost	Rasterprofilfliesen	Rillenplatten	Schriftplatten	Überlaufrinnen	Weitere Schwimmbad-Formteile	Becken	Beckenumfang	Duschen + Umkleiden	Wellness + Spa
Abläufe & Abdeckroste	442																	•	•				
Amano*	32					•													•	•	•	•	
Ascona*	62	•				•	•	•	•	•	•	•	•	•	•				•	•	•	•	
Basic Stone*	74					•													•	•	•	•	
BKS Bamberg	390																	•	•	•			
BKS Berlin**	398																		•				
BKS Finnland	358																	•	•				
BKS Finnland II	364								•					•				•	•				
BKS Skimmer **	406																		•				
BKS St. Moritz**	394																		•				
BKS Wiesbaden - Hochliegender Wasserspiegel	370																	•	•				
BKS Wiesbaden - Tiefliegender Wasserspiegel	382																	•	•				
BKS Wiesbaden Silent	374																		•				
BKS Wiesbaden Stil	378																	•	•				
BKS Wiesbaden – Therapiebecken**	386																		•				
BKS Zürich**	402																		•				
Beckenrandsteine	422																		•	•			
Chroma	300	•																		•	•	•	•
Chroma non-slip	338	•																		•	•	•	•
Chroma unglasiert	346	•				•		•					•					•	•	•	•	•	•
Emotion*	146	•	•	•				•		•	•									•	•	•	•
Fresh*	166					•														•	•	•	•
Hohlkehlen Sockel Radialleisten	414								•										•	•	•	•	
Kauri*	188					•														•	•	•	•
Keramische Rinnenabdeckung 2.0	438																			•			
Loop*	198					•														•	•	•	•
Marble & More*	208					•														•	•	•	•
Nova*	226	•				•	•		•												•	•	
Plural*	234	•				•	•	•												•	•	•	•
Plural non-slip*	252	•				•	•	•													•	•	•
Plural unglasiert*	260	•				•	•	•													•	•	•
Quarzit*	272	•				•	•	•	•	•	•	•	•	•	•	•					•	•	•
Rillenplatten	422																			•			
Savona*	280	•				•	•														•	•	•
Spezialplatten	428									•	•									•	•		
Valley*	312	•				•	•	•	•			•									•	•	•

* Siehe Kapitel Project

** Dieses Beckenkopfsystem setzt sich aus Komponenten mehrerer Serien zusammen. Details dazu finden Sie auf den entsprechenden Informationseiten zum System.

Pool + Spa

Serie		Format																								
		Ab Seite	Fugenbreite: 3 mm	Fugenbreite: 6 mm	1 x 1 cm	Ø1 cm	2,5 x 2,5 cm	Ø2 cm	5 x 5 cm	5 x 60 cm	6,2 x 25 cm	10 x 10 cm	10 x 20 cm	10 x 30 cm	10 x 40 cm	10 x 60 cm	12,5 x 12,5 cm	12,5 x 25 cm	12,5 x 50 cm	12,5 x 100 cm	15 x 15 cm	15 x 30 cm	15 x 60 cm	20 x 20 cm	20 x 40 cm	
Abläufe & Abdeckroste	436																									
Amano*	32	●			●																					
Ascona*	62	●	●					●								●	●			●						
Basic Stone*	74							●																		
BKS Bamberg	390		●																							
BKS Berlin**	398																									
BKS Finnland	358		●																							
BKS Finnland II	364		●													●										
BKS Skimmer **	406																									
BKS St. Moritz**	394																									
BKS Wiesbaden - Hochlieg. Wasserspiegel	370		●																							
BKS Wiesbaden - Tieflieg. Wasserspiegel	382		●																							
BKS Wiesbaden Silent	374																									
BKS Wiesbaden Stil	378		●																							
BKS Wiesbaden - Therapiebecken**	386																									
BKS Zürich**	402																									
Beckenrandsteine	410		●																							
Chroma	330		●						●							●	●	●								
Chroma non-slip	338		●													●	●									
Chroma unglasiert	346		●													●	●									
Emotion*	146	●													●										●	
Fresh*	166	●			●		●																			
Hohlkehlen Sockel Radialleisten	414		●																							
Kauri*	188	●		●	●																					
Keramische Rinnenabdeckung 2.0	438																									
Loop*	198	●		●		●																				
Marble & More*	208	●		●	●																					
Nova*	226	●					●							●						●		●				
Plural*	234	●		●	●	●				●	●	●	●	●				●	●	●	●		●	●	●	●
Plural non-slip*	252	●			●	●				●															●	
Plural unglasiert*	260	●			●	●				●										●				●		
Quarzit*	272	●	●				●								●	●				●						
Rillenplatten	422		●												●											
Savona*	280	●					●													●						
Spezialplatten	428		●												●	●										
Valley*	312	●	●					●	●						●					●		●				

* Siehe Kapitel Project

** Dieses Beckenkopfsystem setzt sich aus Komponenten mehrerer Serien zusammen. Details dazu finden Sie auf den entsprechenden Informationseiten zum System.

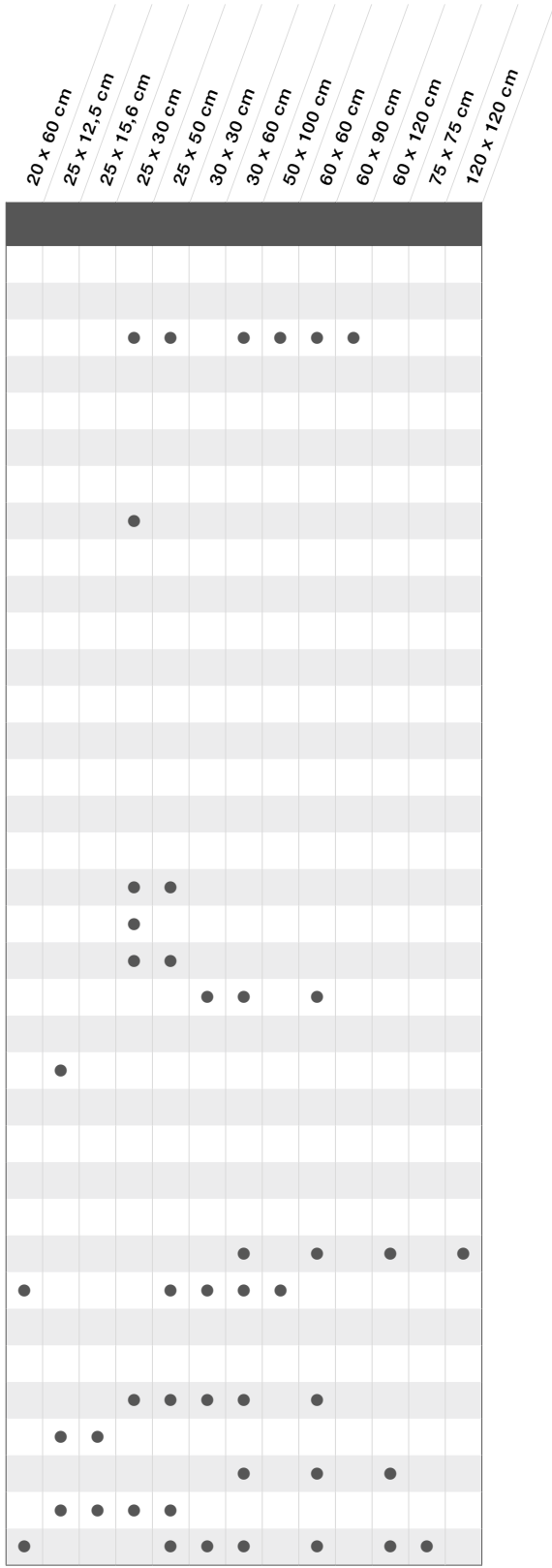





Project



Studioaufnahme / Architekt: Anne Doris Fluck / Serie: Amano / Foto: Jochen Stüber





Tief beeindruckend und lebendig

Inspiziert von der Bewegung des Wassers setzt Amano auf eine weich zeichnende Reliefoberfläche. In Kombination mit fließenden Glasuren erzeugt Amano aquarellähnliche Effekte und verleiht der Serie natürlichen Charme sowie exklusive Lebendigkeit. Amano wird getragen durch zart-transparente, gedeckte Farben sowie weiche Kontraste. Bricht sich das Licht auf der glänzenden Oberfläche beeindruckt Amano mit funkelnden Reflexionen.

Mosaik 2,5 x 2,5 cm



creme, glänzend

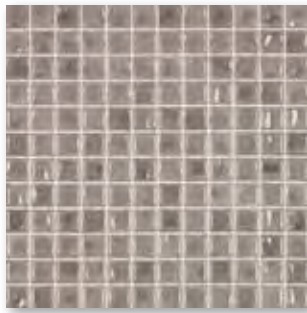

taupe, glänzend



hellgrau, glänzend



mittelgrau, glänzend

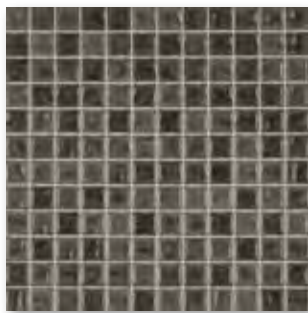

anthrazit, glänzend



eisblau, glänzend

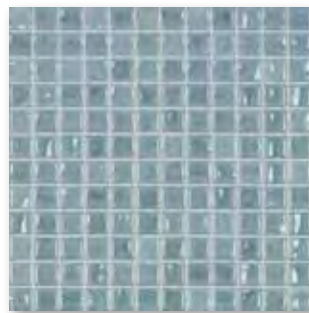

seidenblau, glänzend



pur blau, glänzend

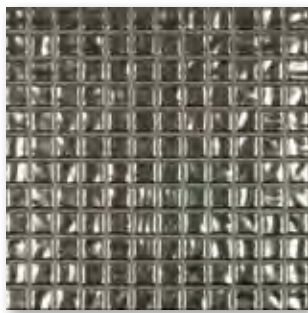

metallic



mittelgrau-metallic-mix



taupe-metallic-mix

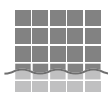

Rückseitig thermoplastisch verklebte Mosaik von AGROB BUCHTAL sind nicht nur im Trockenbereich, sondern auch bedenkenlos im Unterwasserbereich (z. B. Schwimmbecken/Whirlpool) sowie im dauernassbelasteten Bereich (z. B. Beckenumgänge/Duschen) einsetzbar.

Mosaik

2,5 x 2,5 cm



Mosaik, rückseitig thermoplastisch verklebt
Bogen: 297 x 297 mm



						2,5 x 2,5 / 1 x 1	Beanspruchungsgruppe	Nennmaß	
						23 x 23 x 6,5 mm			Herstellmaß
						glänzend, reliefiert			Oberfläche
						11 Bögen			m ² - Stück
						12,100			m ² - kg
						11 Bögen			Paket - Stück
						1,000			Paket - m ²
						12,100			Paket - kg
						48,000			Palette - m ²
						580,800			Palette - kg
						Blb			Produktnorm
						1 - 2			Belastung
						41920H ¹		3	creme
						Preisgr. A230 (m ²)			
						41921H ¹		3	taupe
						Preisgr. A230 (m ²)			
						41922H ¹	3	hellgrau	
						Preisgr. A230 (m ²)			
						41923H ¹	3	mittelgrau	
						Preisgr. A230 (m ²)			
						41924H ¹	2	anthrazit	
						Preisgr. A230 (m ²)			
						41925H ¹	3	eisblau	
						Preisgr. A230 (m ²)			
						41926H ¹	3	seidenblau	
						Preisgr. A230 (m ²)			
						41927H ¹	2	pur blau	
						Preisgr. A230 (m ²)			
						41928H ^{2/3}	2	metallic	
						Preisgr. A474 (St.)			
						41929H ^{2/3}	2	mittelgrau-metallic-mix	
						Preisgr. A458 (St.)			
						41930H ^{2/3}	2	taupe-metallic-mix	
						Preisgr. A458 (St.)			

¹ Color Shade Variation: V1

² Color Shade Variation: V2

³ Nicht oder nur bedingt säure- und laugenbeständig



3D-Rendering / Serie: Area Pro

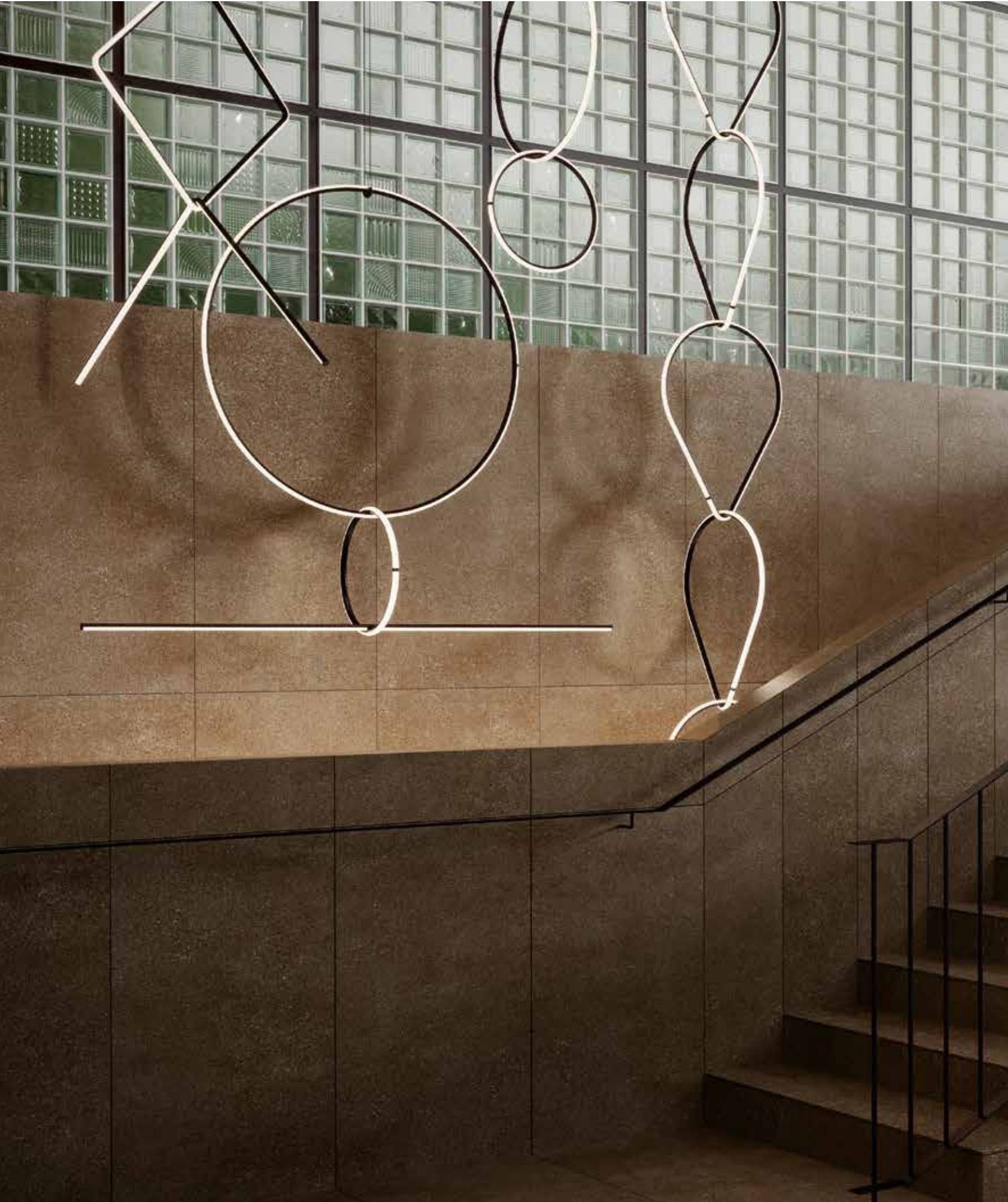



Natürlich intuitiv

Gutes Design vermittelt immer einen intuitiven Zugang zu dessen Nutzung – so geht auch das Gestalten mit Area Pro leicht von der Hand. Die breite Produktpalette regt mit Erdtönen und einer angenehmen Haptik unmittelbar zu Ideen für ihren Einsatz an. Die von feinkörnigem, geschichtetem Kalkstein inspirierte Serie fügt sich mühelos ein und hebt sich zugleich ab. Das macht die



Fliesen und ihr Zubehör zu perfekten Allroundern in fast jedem Ambiente. Die neue Serie strahlt bereits jetzt das Potenzial aus, ein Klassiker zu werden. Area Pro ist das keramische Pendant zum kleinen Schwarzen oder einem klassischen weißen Hemd. Ob in Bürogebäuden, Wohnhäusern oder Freizeiteinrichtungen – die Serie überzeugt, wie die Modeklassiker, in jeder Umgebung und ist damit ein wahres Multitalent. Alle Fliesen können richtungsunabhängig verlegt werden. Zudem bestechen sie durch ihre Vielseitigkeit und eine Vielzahl an Formaten und Farbtönen. Alle Farben von Area Pro sind auf die Serie ChromaPlural von AGROB BUCHTAL abgestimmt, sodass sie vielfältig miteinander kombiniert werden können. Darüber hinaus sind mit dieser Serie auch maßgeschneiderte Projekte möglich.





Grid

Um dem eigenen Anspruch gerecht zu werden, hohe Funktionalität mit anspruchsvollem Design zu verbinden, verpflichtete AGROB BUCHTAL Design-Shootingstar Sebastian Herkner, der sonst für Marken wie Thonet, Ligne Roset oder Moroso tätig ist. Er kreierte einen völlig neuen Entwurf für die Oberfläche der höchsten Rutschhemmungsklasse. Das Ergebnis: the Grid.



Smarte Eigenschaften

Immer perfekter Halt



Area Pro ist mit diversen rutschhemmenden Oberflächen erhältlich, darunter Grid, mit einer Trittsicherheit von R12V4.

Nachhaltige, dünne Wandfliesen



Bei den 6 mm dünnen Wandfliesen ist der Materialaufwand geringer. Weniger Material bedeutet weniger Energie bei Herstellung und Transport sowie ein geringeres Gewicht.

Innovation DryTile



Das DryTile-System ist für die Bodenfliesen zwischen 30 x 60 cm und 60 x 120 cm erhältlich. DryTile ist eine innovative Technologie, bei der Fliesen auf der Rückseite mit Kork-Verbundstoff beschichtet und ohne den Einsatz von Kleber verlegt werden.

Hytect, die photokatalytische Oberfläche



Area Pro Fliesen sind mit der nachhaltigen Hytect-Oberfläche versehen, die sie höchst reinigungsfreundlich machen. Hytect schützt keramische Fliesen zudem vor Bakterien und Schimmel und neutralisiert Luftschadstoffe und störende Gerüche.

Waschtische und Duschböden



Area Pro beinhaltet auch eine Auswahl an Keramikwaschtischen und Keramikduschböden, die in allen zwölf Farben der Serie erhältlich sind.

Abdeckrost aus Keramik



Für Fliesen, die in Schwimmbädern um das Becken herum verlegt werden, bietet AGROB BUCHTAL den passenden Abschluss, der für optische Kontinuität sorgt: einen Abdeckrost mit wasserstrahlgeschnittenen Öffnungen.



R10/A R10/B R11/B R11/C R12/C R12V4



FEINSTEINZEUG

Formate in cm	Mosaik			Softcorn 2	Perlstic	Grid	30 x 30	10 x 60	15 x 60
	10 x 10	15 x 15	20 x 20	20 x 20	20 x 20	20 x 20			

Trittsicherheiten	R10/B R11/C	R10/B R11/C	R10/A	R11/B	R12/C	R12V4	R10/A R11/B	R10/A	R10/A
Stärke	6,5 mm	10,5 mm	10,5 mm	10,5 mm	10,5 mm	10,5 mm	10,5 mm	10,5 mm	10,5 mm
Oberfläche	eben matt	eben matt	eben matt	strukturiert matt	gekörnt matt	profiliert matt	eben matt	eben matt	eben matt
	●	●	●	●	●	●	●	●	●
	●	●	●	●	●	●	●	●	●
	●	●	●	●	●	●	●	●	●
	●						●	●	●
	●						●	●	●
	●	●	●	●	●	●	●	●	●
	●	●	●	●	●	●	●	●	●
	●						●	●	●
	●						●	●	●
	●	●	●	●	●	●	●	●	●
	●						●	●	●
	●						●	●	●

Grid

30 x 60

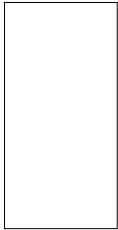

60 x 60

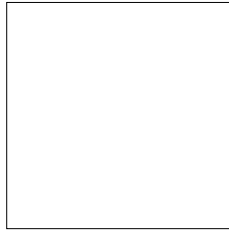

60 x 60

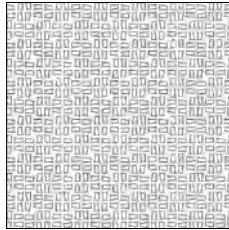

60 x 90



60 x 120

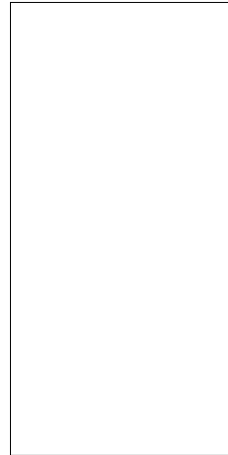



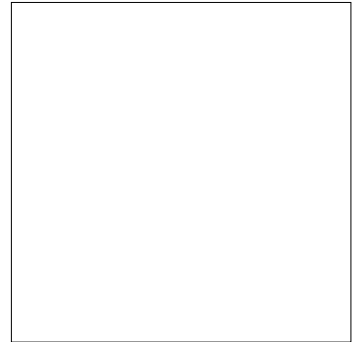



90 x 90 *









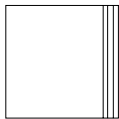
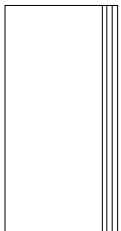





R10/A R11/B R12/C	R10/A	R11/B	R12V4	R10/A	R10/A R11/B	R10/A
10,5 mm** eben matt	10,5 mm eben matt	10,5 mm eben matt	10,5 mm profiliert matt	10,5 mm eben matt	10,5 mm eben matt	11 mm eben matt
●	●	●	●	●	●	●
●	●	●	●	●	●	●
●	●	●	●	●	●	●
●	●	●	●	●	●	●
●	●	●	●	●	●	●
●	●	●	●	●	●	●
●	●	●	●	●	●	●
●	●	●	●	●	●	●
●	●	●	●	●	●	●
●	●	●	●	●	●	●
●	●	●	●	●	●	●
●	●	●	●	●	●	●
●	●	●	●	●	●	●

* Protecta-Vergütung
 ** Auf Anfrage auch in Überstärke 15 mm lieferbar.

FEINSTEINZEUG

Formate in cm	Hohlkehlsockel dekoriert				Innenecke	Außenecke	Treppenfliese	
	10 x 10	10 x 20	10 x 30	10 x 60	10,2 x 2,0	10,2 x 3,5	30 x 30	30 x 60
								

Trittsicherheiten	R10/B	R10/A	R10/A	R10/A			R10/A	R10/A
Stärke	6,5 mm	9 mm	9 mm	9 mm	9 mm	9 mm	10,5 mm	10,5 mm
Oberfläche	eben matt	eben matt	eben matt	eben matt	eben matt	eben matt	eben matt	eben matt
 anthrazit	●	●	●	●	●	●	●	●
 basalt	●	●	●	●	●	●	●	●
 kiesel	●	●	●	●	●	●	●	●
 stein	●	●	●	●	●	●	●	●
 sandweiß	●	●	●	●	●	●	●	●
 sandgrau	●	●	●	●	●	●	●	●
 sand	●	●	●	●	●	●	●	●
 muskat	●	●	●	●	●	●	●	●
 platin	●	●	●	●	●	●	●	●
 sandbeige	●	●	●	●	●	●	●	●
 ziegel	●	●	●	●	●	●	●	●
 lehm	●	●	●	●	●	●	●	●

Treppenfliese mit Schräge	Setzstufe	Treppenkante	Sockel, gerundet
------------------------------	-----------	--------------	---------------------

31 x 135	28 x 135	4 x 60	7 x 60
----------	----------	--------	--------

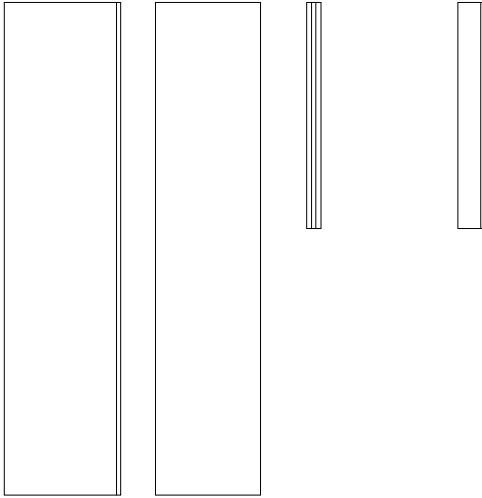

R10/A	R10/A	R10/A	
-------	-------	-------	--

10,5 mm eben matt	10,5 mm eben matt	10,5 mm eben matt	10,5 mm eben matt
-------------------------	-------------------------	-------------------------	-------------------------

●	●	●	●
●	●	●	●
●	●	●	●
●	●	●	●
●	●	●	●
●	●	●	●
●	●	●	●
●	●	●	●
●	●	●	●
●	●	●	●
●	●	●	●
●	●	●	●
●	●	●	●
●	●	●	●
●	●	●	●
●	●	●	●
●	●	●	●
●	●	●	●
●	●	●	●

STEINGUT

Wandfliese

Formate in cm	30 x 60	30 x 90
---------------	---------	---------

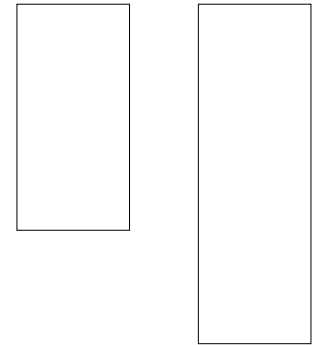

Stärke	6 mm	6 mm
Oberfläche	eben steinmatt	eben steinmatt

	weiß	●	●
	grau	●	●
	beige	●	●



R10/A R10/B R11/B R11/C R12/C R12V4



Oberflächen: Bodenfliesen



eben

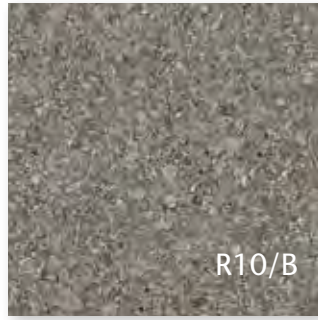

eben

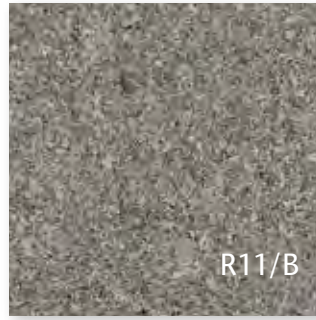

eben



eben



ziegel



platin

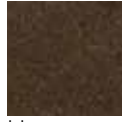

lehm



sandgrau



muskat



stein



sand



kiesel



sandbeige



basalt



sandweiß



anthrazit



Bodenfliese 15 x 15 cm
Feinsteinzeug, eben, R10/B
Feinsteinzeug, eben, R11/C

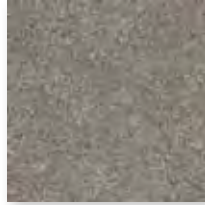

Bodenfliese 20 x 20 cm
Feinsteinzeug, eben, R10/A
Feinsteinzeug, Softcorn 2, R11/B
Feinsteinzeug, Perlstic, R12/C
Feinsteinzeug, Grid, R12V4



Bodenfliese 30 x 30 cm
Feinsteinzeug, eben, R10/A
Feinsteinzeug, eben, R11/B



Riegelformat 10 x 60 cm
Feinsteinzeug, eben, R10/A



Riegelformat 15 x 60 cm
Feinsteinzeug, eben, R10/A

Mosaik 10 x 10 cm



Mosaikbogen 30 x 30 cm
Feinsteinzeug, eben, R10/B
Feinsteinzeug, eben, R11/C

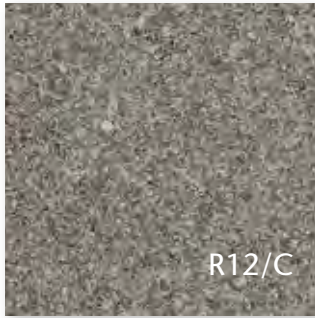

eben

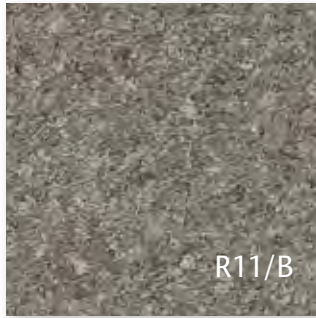

Softcorn 2

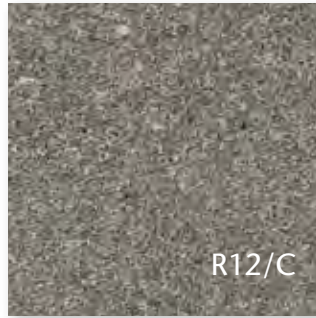

Perlstic



Grid



*Bodenfliese 60 x 60 cm
Feinsteinzeug, eben, R10/A
Feinsteinzeug, eben, R11/B
Feinsteinzeug, Grid, R12V4*

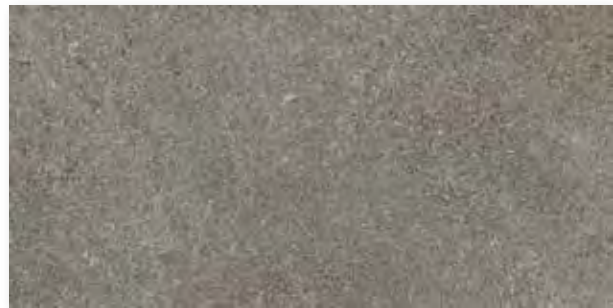

*Bodenfliese 30 x 60 cm
Feinsteinzeug, eben, R10/A
Feinsteinzeug, eben, R11/B
Feinsteinzeug, eben, R12/C*



*Bodenfliese 60 x 90 cm
Feinsteinzeug, eben, R10/A*



R10/A R11/B



Bodenfliese 90 x 90 cm
Feinsteinzeug, eben, R10/A



Bodenfliese 60 x 120 cm
Feinsteinzeug, eben, R10/A
Feinsteinzeug, eben, R11/B



Treppenfliese 30 x 30 cm (rilliert)
Feinsteinzeug, eben, R10/A



Treppenfliese 30 x 60 cm (rilliert)
Feinsteinzeug, eben, R10/A



Treppenfliese mit Schräge 31 x 135 cm
Feinsteinzeug, eben, R10/A



Setzstufe 28 x 135 cm
Feinsteinzeug, eben, R10/A

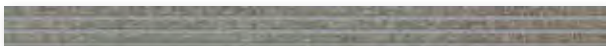

Treppenkante 4 x 60 cm
Feinsteinzeug, eben, R10/A



Sockel, gerundet 7 x 60 cm
Feinsteinzeug, eben



Kehlsockel 10 x 10 cm
Feinsteinzeug, eben, R10/A



Kehlsockel 10 x 20 cm
Feinsteinzeug, eben, R10/A



Kehlsockel 10 x 30 cm
Feinsteinzeug, eben, R10/A



Kehlsockel 10 x 60 cm
Feinsteinzeug, eben, R10/A



Innenecke zu Kehlsockel
Feinsteinzeug, eben



Außenecke zu Kehlsockel
Feinsteinzeug, eben



*Wandfliese 30 x 60 cm
Steingut, eben, steinmatt, weiß*



*Wandfliese 30 x 60 cm
Steingut, eben, steinmatt, grau*



*Wandfliese 30 x 60 cm
Steingut, eben, steinmatt, beige*

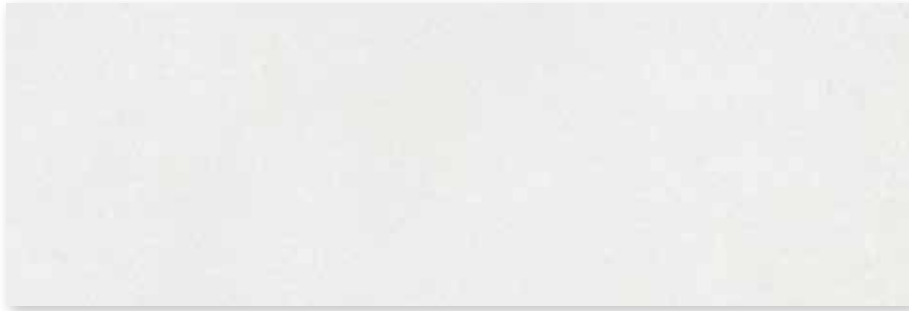

*Wandfliese 30 x 90 cm
Steingut, eben, steinmatt, weiß*



*Wandfliese 30 x 90 cm
Steingut, eben, steinmatt, grau*



*Wandfliese 30 x 90 cm
Steingut, eben, steinmatt, beige*



R10/A R11/B



Keramische Rinnenabdeckung,
Ecklösung 30 x 30 cm



Flachrinnensystem
(Muldentiefe 5 mm)



Keramische Rinnenabdeckung
25 x 50 cm

Flachrinne
25 x 50 cm

Details siehe Kapitel Pool + Spa; Keramische Rinnenabdeckung 2.0,
Seite 438 ff. (auftragsbezogene Fertigung).

ohne Abbildung:
Rinnenstein mit Ablauf,
Gehrungspaar, Endstück





Waschtisch SURF small 40 x 60 cm**



Waschtisch SURF medium 45 x 80 cm**



Waschtisch SURF large 55 x 120 cm**

**(auf Anfrage lieferbar.) Weitere Informationen zu Surf auf Seite 292 ff.*

Wandfliesen

30 x 60 cm

30 x 90 cm¹Bodenfliesen²

10 x 10 cm



10 x 10 cm



Mosaik, rückseitig
thermoplastisch verklebt,
Bogen 297 x 297 mm

Mosaik, rückseitig
thermoplastisch verklebt,
Bogen 297 x 297 mm

Nennmaß - cm/in	30 x 60 / 12 x 24	30 x 90 / 12 x 36	10 x 10 / 4 x 4	10 x 10 / 4 x 4
Herstellmaß	297 x 597 x 6 mm	297 x 897 x 6 mm	97 x 97 x 6,5 mm	97 x 97 x 6,5 mm
Oberfläche	steinmatt, eben	steinmatt, eben	eben, matt	eben, matt
m ² - Stück	5,556	3,704	11 Bögen	11 Bögen
m ² - kg	10,279	10,400	13,101	13,101
Paket - Stück	13	8	11 Bögen	11 Bögen
Paket - m ²	2,339	2,160	1,000	1,000
Paket - kg	24,050	22,464	13,101	13,101
Palette - m ²	112,311	51,836	64,000	64,000
Palette - kg	1.154,444	539,136	838,464	838,464
Produktnorm	BIII	BIII	Bla	Bla
Trittsicherheit			R10/B	R11/C
Belastung			1 - 2	1 - 2
weiß	203232H Preisgr. A67 (m ²)	323235H Preisgr. A94 (m ²)		
grau	203233H Preisgr. A67 (m ²)	323236H Preisgr. A94 (m ²)		
beige	203234H Preisgr. A67 (m ²)	323237H Preisgr. A94 (m ²)		
anthrazit			430220H Preisgr. A113 (m ²)	430232H Preisgr. A113 (m ²)
basalt			430221H Preisgr. A113 (m ²)	430233H Preisgr. A113 (m ²)
kiesel			430222H Preisgr. A113 (m ²)	430234H Preisgr. A113 (m ²)
stein			430223H Preisgr. A113 (m ²)	430235H Preisgr. A113 (m ²)
sandweiß			430224H Preisgr. A113 (m ²)	430236H Preisgr. A113 (m ²)
sandgrau			430225H Preisgr. A113 (m ²)	430237H Preisgr. A113 (m ²)
sand			430226H Preisgr. A113 (m ²)	430238H Preisgr. A113 (m ²)
muskat			430227H Preisgr. A113 (m ²)	430239H Preisgr. A113 (m ²)
platin			430228H Preisgr. A113 (m ²)	430240H Preisgr. A113 (m ²)
sandbeige			430229H Preisgr. A113 (m ²)	430241H Preisgr. A113 (m ²)
ziegel			430230H Preisgr. A113 (m ²)	430242H Preisgr. A113 (m ²)
lehm			430231H Preisgr. A113 (m ²)	430243H Preisgr. A113 (m ²)

¹ Kanten geschliffen

Alle Produkte: Color Shade Variation V2



Bodenfliesen

15 x 15 cm



15 x 15 cm



20 x 20 cm



20 x 20 cm



20 x 20 cm



20 x 20 cm



	15 x 15 / 6 x 6	15 x 15 / 6 x 6	20 x 20 / 8 x 8	20 x 20 / 8 x 8	20 x 20 / 8 x 8	20 x 20 / 8 x 8	
	147 x 147 x 10,5 mm	147 x 147 x 10,5 mm	197 x 197 x 10,5 mm	197 x 197 x 10,5 mm	197 x 197 x 10,5 mm	197 x 197 x 10,5 mm	Nennmaß - cm/in
	eben, matt	eben, matt	eben, matt	strukturiert, matt	gekörnt, matt	profiliert, matt	Herstellmaß
	44,444	44,444	25,000	25,000	25,000	25,000	Oberfläche
	23,111	23,111	22,900	22,900	22,900	22,900	m ² - Stück
	27	27	21	21	21	21	m ² - kg
	0,607	0,607	0,840	0,840	0,840	0,840	Paket - Stück
	14,040	14,040	19,236	19,236	19,236	19,236	Paket - m ²
	48,600	48,600	50,400	50,400	50,400	50,400	Paket - kg
	1.123,200	1.123,200	1.154,160	1.154,160	1.154,160	1.154,160	Palette - m ²
	Bla	Bla	Bla	Bla	Bla	Bla	Palette - kg
	R10/B	R11/C	R10/A	R11/B	R12/C	R12V4	Produktnorm
	2 - 3	2 - 3	3	3	3	3	Trittsicherheit
	430244H	430256H	430268H	430274H	430280H	430286H	Belastung
	Preisgr. A101 (m ²)	Preisgr. A101 (m ²)	Preisgr. A94 (m ²)	Preisgr. A94 (m ²)	Preisgr. A125 (m ²)	Preisgr. A125 (m ²)	anthrazit
	430245H	430257H	430269H	430275H	430281H	430287H	basalt
	Preisgr. A101 (m ²)	Preisgr. A101 (m ²)	Preisgr. A94 (m ²)	Preisgr. A94 (m ²)	Preisgr. A125 (m ²)	Preisgr. A125 (m ²)	kiesel
	430246H	430258H	430270H	430276H	430282H	430288H	kiesel
	Preisgr. A101 (m ²)	Preisgr. A101 (m ²)	Preisgr. A94 (m ²)	Preisgr. A94 (m ²)	Preisgr. A125 (m ²)	Preisgr. A125 (m ²)	sandgrau
	430249H	430261H	430271H	430277H	430283H	430289H	sandgrau
	Preisgr. A101 (m ²)	Preisgr. A101 (m ²)	Preisgr. A94 (m ²)	Preisgr. A94 (m ²)	Preisgr. A125 (m ²)	Preisgr. A125 (m ²)	sand
	430250H	430262H	430272H	430278H	430284H	430290H	sand
	Preisgr. A101 (m ²)	Preisgr. A101 (m ²)	Preisgr. A94 (m ²)	Preisgr. A94 (m ²)	Preisgr. A125 (m ²)	Preisgr. A125 (m ²)	sandbeige
	430253H	430265H	430273H	430279H	430285H	430291H	sandbeige
	Preisgr. A101 (m ²)	Preisgr. A101 (m ²)	Preisgr. A94 (m ²)	Preisgr. A94 (m ²)	Preisgr. A125 (m ²)	Preisgr. A125 (m ²)	

Alle Produkte: Color Shade Variation V2



Bodenfliesen

30 x 30 cm



30 x 30 cm



10 x 60 cm^{1/2}



15 x 60 cm^{1/2}



30 x 60 cm^{1/3}



30 x 60 cm¹



30 x 60 cm¹



Riegelformat

Riegelformat

Nennmaß - cm/in	30 x 30 / 12 x 12	30 x 30 / 12 x 12	10 x 60 / 4 x 24	15 x 60 / 6 x 24	30 x 60 / 12 x 24	30 x 60 / 12 x 24	30 x 60 / 12 x 24
Herstellmaß	297 x 297 x 10,5 mm	297 x 297 x 10,5 mm	97 x 597 x 10,5 mm	147 x 597 x 10,5 mm	297 x 597 x 10,5 mm	297 x 597 x 10,5 mm	297 x 597 x 10,5 mm
Oberfläche	eben, matt	eben, matt	eben, matt	eben, matt	eben, matt	eben, matt	eben, matt
m ² - Stück	11,111	11,111	16,667	11,111	5,556	5,556	5,556
m ² - kg	23,142	23,142	23,667	23,222	23,224	23,224	23,224
Paket - Stück	11	11	15	11	6	6	6
Paket - m ²	0,990	0,990	0,900	0,990	1,080	1,080	1,080
Paket - kg	22,913	22,913	21,300	22,990	25,080	25,080	25,080
Palette - m ²	47,525	47,525	36,000	39,600	43,200	43,200	43,200
Palette - kg	1.099,824	1.099,824	852,012	919,600	1.003,200	1.003,200	1.003,200
Produktnorm	Bla	Bla	Bla	Bla	Bla	Bla	Bla
Trittsicherheit	R10/A	R11/B	R10/A	R10/A	R10/A	R11/B	R12/C
Belastung	2 - 3	2 - 3	2 - 3	2 - 3	2 - 3	2 - 3	2 - 3
anthrazit	430292H Preisgr. A67 (m ²)	430304H Preisgr. A67 (m ²)	430316H Preisgr. A167 (m ²)	430328H Preisgr. A167 (m ²)	430340H Preisgr. A81 (m ²)	430352H Preisgr. A81 (m ²)	430364H Preisgr. A119 (m ²)
basalt	430293H Preisgr. A67 (m ²)	430305H Preisgr. A67 (m ²)	430317H Preisgr. A167 (m ²)	430329H Preisgr. A167 (m ²)	430341H Preisgr. A81 (m ²)	430353H Preisgr. A81 (m ²)	430365H Preisgr. A119 (m ²)
kiesel	430294H Preisgr. A67 (m ²)	430306H Preisgr. A67 (m ²)	430318H Preisgr. A167 (m ²)	430330H Preisgr. A167 (m ²)	430342H Preisgr. A81 (m ²)	430354H Preisgr. A81 (m ²)	430366H Preisgr. A119 (m ²)
stein	430295H Preisgr. A67 (m ²)	430307H Preisgr. A67 (m ²)	430319H Preisgr. A167 (m ²)	430331H Preisgr. A167 (m ²)	430343H Preisgr. A81 (m ²)	430355H Preisgr. A81 (m ²)	430367H Preisgr. A119 (m ²)
sandweiß	430296H Preisgr. A67 (m ²)	430308H Preisgr. A67 (m ²)	430320H Preisgr. A167 (m ²)	430332H Preisgr. A167 (m ²)	430344H Preisgr. A81 (m ²)	430356H Preisgr. A81 (m ²)	430368H Preisgr. A119 (m ²)
sandgrau	430297H Preisgr. A67 (m ²)	430309H Preisgr. A67 (m ²)	430321H Preisgr. A167 (m ²)	430333H Preisgr. A167 (m ²)	430345H Preisgr. A81 (m ²)	430357H Preisgr. A81 (m ²)	430369H Preisgr. A119 (m ²)
sand	430298H Preisgr. A67 (m ²)	430310H Preisgr. A67 (m ²)	430322H Preisgr. A167 (m ²)	430334H Preisgr. A167 (m ²)	430346H Preisgr. A81 (m ²)	430358H Preisgr. A81 (m ²)	430370H Preisgr. A119 (m ²)
muskat	430299H Preisgr. A67 (m ²)	430311H Preisgr. A67 (m ²)	430323H Preisgr. A167 (m ²)	430335H Preisgr. A167 (m ²)	430347H Preisgr. A81 (m ²)	430359H Preisgr. A81 (m ²)	430371H Preisgr. A119 (m ²)
platin	430300H Preisgr. A67 (m ²)	430312H Preisgr. A67 (m ²)	430324H Preisgr. A167 (m ²)	430336H Preisgr. A167 (m ²)	430348H Preisgr. A81 (m ²)	430360H Preisgr. A81 (m ²)	430372H Preisgr. A119 (m ²)
sandbeige	430301H Preisgr. A67 (m ²)	430313H Preisgr. A67 (m ²)	430325H Preisgr. A167 (m ²)	430337H Preisgr. A167 (m ²)	430349H Preisgr. A81 (m ²)	430361H Preisgr. A81 (m ²)	430373H Preisgr. A119 (m ²)
ziegel	430302H Preisgr. A67 (m ²)	430314H Preisgr. A67 (m ²)	430326H Preisgr. A167 (m ²)	430338H Preisgr. A167 (m ²)	430350H Preisgr. A81 (m ²)	430362H Preisgr. A81 (m ²)	430374H Preisgr. A119 (m ²)
lehm	430303H Preisgr. A67 (m ²)	430315H Preisgr. A67 (m ²)	430327H Preisgr. A167 (m ²)	430339H Preisgr. A167 (m ²)	430351H Preisgr. A81 (m ²)	430363H Preisgr. A81 (m ²)	430375H Preisgr. A119 (m ²)

Alle Produkte: Color Shade Variation V2



¹ rektifiziert

² Auftragsfertigung: Rückgabe und/oder Stornierung bestellter Ware nicht möglich.

³ Auf Anfrage auch in Überstärke 15 mm lieferbar.

Bodenfliesen¹

60 x 60 cm

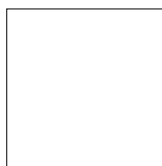

60 x 60 cm



60 x 60 cm

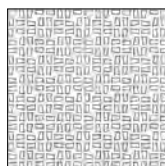

60 x 90 cm



60 x 120 cm

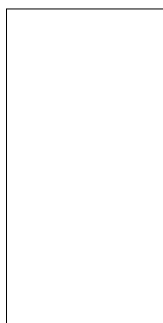

60 x 120 cm



90 x 90 cm^{2/3}

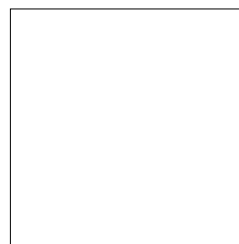

Grid

60 x 60 / 24 x 24	60 x 60 / 24 x 24	60 x 60 / 24 x 24	60 x 90 / 24 x 36	60 x 120 / 24 x 48	60 x 120 / 24 x 48	90 x 90 / 36 x 36	Nennmaß - cm/in
597 x 597 x 10,5 mm	597 x 597 x 10,5 mm	597 x 597 x 10,5 mm	597 x 897 x 10,5 mm	597 x 1197 x 10,5 mm	597 x 1197 x 10,5 mm	895 x 895 x 11 mm	Herstellmaß
eben, matt	eben, matt	profiliert, matt	eben, matt	eben, matt	eben, matt	eben, matt	Oberfläche
2,778	2,778	2,778	1,851	1,389	1,389	1,234	m ² - Stück
23,769	23,769	23,769	23,367	23,804	23,804	24,691	m ² - kg
3	3	3	2	2	2	2	Paket - Stück
1,080	1,080	1,080	1,080	1,441	1,441	1,620	Paket - m ²
25,668	25,668	25,668	25,248	34,300	34,300	40,018	Paket - kg
38,880	38,880	38,880	22,690	30,238	30,238	48,622	Palette - m ²
924,048	924,048	924,048	530,208	720,300	720,300	1.200,540	Palette - kg
Bla	Bla	Bla	Alb	Alb	Alb	Bla	Produktnorm
R10/A	R11/B	R12V4	R10/A	R10/A	R11/B	R10/A	Trittsicherheit
2 - 3	2 - 3	2 - 3	2 - 3	2 - 3	2 - 3	2 - 3	Belastung
430380H	430214H	430392H	430576H	430398H	430410H	430422	anthrazit
Preisgr. A94 (m ²)	Preisgr. A94 (m ²)	Preisgr. A139 (m ²)	Preisgr. A119 (m ²)	Preisgr. A119 (m ²)	Preisgr. A119 (m ²)	Preisgr. A150 (m ²)	
430381H	430215H	430393H	430577H	430399H	430411H	430423	basalt
Preisgr. A94 (m ²)	Preisgr. A94 (m ²)	Preisgr. A139 (m ²)	Preisgr. A119 (m ²)	Preisgr. A119 (m ²)	Preisgr. A119 (m ²)	Preisgr. A150 (m ²)	
430382H	430216H	430394H	430578H	430400H	430412H	430424	kiesel
Preisgr. A94 (m ²)	Preisgr. A94 (m ²)	Preisgr. A139 (m ²)	Preisgr. A119 (m ²)	Preisgr. A119 (m ²)	Preisgr. A119 (m ²)	Preisgr. A150 (m ²)	
430383H			430579H	430401H	430413H		stein
Preisgr. A94 (m ²)			Preisgr. A119 (m ²)	Preisgr. A119 (m ²)	Preisgr. A119 (m ²)		
430384H			430580H	430402H	430414H		sandweiß
Preisgr. A94 (m ²)			Preisgr. A119 (m ²)	Preisgr. A119 (m ²)	Preisgr. A119 (m ²)		
430385H	430217H	430395H	430581H	430403H	430415H	430425	sandgrau
Preisgr. A94 (m ²)	Preisgr. A94 (m ²)	Preisgr. A139 (m ²)	Preisgr. A119 (m ²)	Preisgr. A119 (m ²)	Preisgr. A119 (m ²)	Preisgr. A150 (m ²)	
430386H	430218H	430396H	430582H	430404H	430416H	430426	sand
Preisgr. A94 (m ²)	Preisgr. A94 (m ²)	Preisgr. A139 (m ²)	Preisgr. A119 (m ²)	Preisgr. A119 (m ²)	Preisgr. A119 (m ²)	Preisgr. A150 (m ²)	
430387H			430583H	430405H	430417H		muskat
Preisgr. A94 (m ²)			Preisgr. A119 (m ²)	Preisgr. A119 (m ²)	Preisgr. A119 (m ²)		
430388H			430584H	430406H	430418H		platin
Preisgr. A94 (m ²)			Preisgr. A119 (m ²)	Preisgr. A119 (m ²)	Preisgr. A119 (m ²)		
430389H	430219H	430397H	430585H	430407H	430419H	430427	sandbeige
Preisgr. A94 (m ²)	Preisgr. A94 (m ²)	Preisgr. A139 (m ²)	Preisgr. A119 (m ²)	Preisgr. A119 (m ²)	Preisgr. A119 (m ²)	Preisgr. A150 (m ²)	
430390H			430586H	430408H	430420H		ziegel
Preisgr. A94 (m ²)			Preisgr. A119 (m ²)	Preisgr. A119 (m ²)	Preisgr. A119 (m ²)		
430391H			430587H	430409H	430421H		lehm
Preisgr. A94 (m ²)			Preisgr. A119 (m ²)	Preisgr. A119 (m ²)	Preisgr. A119 (m ²)		



rekтифициert

Alle Produkte: Color Shade Variation V2

² ohne Hytect-Veredelung;
mit Protecta-Vergütung

³ Achtung: Sonderpalette, keine Rücknahme,
kein Umtausch



Hohlkehlssockel dekoriert

Innenecke

Außenecke

10 x 10 cm



10 x 20 cm



10 x 30 cm



10 x 60 cm



Nennmaß - cm/in	10 x 10 / 4 x 4	10 x 20 / 4 x 8	10 x 30 / 4 x 12	10 x 60 / 4 x 24		
Herstellmaß	100 x 97 x 6,5 mm	102 x 197 x 9 mm	102 x 297 x 9 mm	102 x 597 x 9 mm	102 x 20 x 9 mm	102 x 35 x 9 mm
Oberfläche	eben, matt	eben, matt	eben, matt	eben, matt	eben, matt	eben, matt
m - Stück	10,000	5,000	3,333	1,667		
m/St. - kg	1,500/m	2,000/m	1,999/m	2,000/m	0,080/Stück	0,080/Stück
Paket - Stück	40	20	16	16	18	12
Paket - m	4,000	4,000	4,800	9,598		
Paket - kg	6,000	8,000	9,600	19,200	1,440	0,960
Produktnorm	Bla	Bla	Bla	Bla	Bla	Bla
Trittsicherheit	R10/B	R10/A	R10/A	R10/A		
anthrazit	430564H Preisgr. A411 (St.)	430428H Preisgr. A419 (St.)	430440H Preisgr. A425 (St.)	430452H Preisgr. A445 (St.)	430480H Preisgr. A418 (St.)	430492H Preisgr. A418 (St.)
basalt	430565H Preisgr. A411 (St.)	430429H Preisgr. A419 (St.)	430441H Preisgr. A425 (St.)	430453H Preisgr. A445 (St.)	430481H Preisgr. A418 (St.)	430493H Preisgr. A418 (St.)
kiesel	430566H Preisgr. A411 (St.)	430430H Preisgr. A419 (St.)	430442H Preisgr. A425 (St.)	430454H Preisgr. A445 (St.)	430482H Preisgr. A418 (St.)	430494H Preisgr. A418 (St.)
stein	430567H Preisgr. A411 (St.)	430431H Preisgr. A419 (St.)	430443H Preisgr. A425 (St.)	430455H Preisgr. A445 (St.)	430483H Preisgr. A418 (St.)	430495H Preisgr. A418 (St.)
sandweiß	430568H Preisgr. A411 (St.)	430432H Preisgr. A419 (St.)	430444H Preisgr. A425 (St.)	430456H Preisgr. A445 (St.)	430484H Preisgr. A418 (St.)	430496H Preisgr. A418 (St.)
sandgrau	430569H Preisgr. A411 (St.)	430433H Preisgr. A419 (St.)	430445H Preisgr. A425 (St.)	430457H Preisgr. A445 (St.)	430485H Preisgr. A418 (St.)	430497H Preisgr. A418 (St.)
sand	430570H Preisgr. A411 (St.)	430434H Preisgr. A419 (St.)	430446H Preisgr. A425 (St.)	430458H Preisgr. A445 (St.)	430486H Preisgr. A418 (St.)	430498H Preisgr. A418 (St.)
muskat	430571H Preisgr. A411 (St.)	430435H Preisgr. A419 (St.)	430447H Preisgr. A425 (St.)	430459H Preisgr. A445 (St.)	430487H Preisgr. A418 (St.)	430499H Preisgr. A418 (St.)
platin	430572H Preisgr. A411 (St.)	430436H Preisgr. A419 (St.)	430448H Preisgr. A425 (St.)	430460H Preisgr. A445 (St.)	430488H Preisgr. A418 (St.)	430500H Preisgr. A418 (St.)
sandbeige	430573H Preisgr. A411 (St.)	430437H Preisgr. A419 (St.)	430449H Preisgr. A425 (St.)	430461H Preisgr. A445 (St.)	430489H Preisgr. A418 (St.)	430501H Preisgr. A418 (St.)
ziegel	430574H Preisgr. A411 (St.)	430438H Preisgr. A419 (St.)	430450H Preisgr. A425 (St.)	430462H Preisgr. A445 (St.)	430490H Preisgr. A418 (St.)	430502H Preisgr. A418 (St.)
lehm	430575H Preisgr. A411 (St.)	430439H Preisgr. A419 (St.)	430451H Preisgr. A425 (St.)	430463H Preisgr. A445 (St.)	430491H Preisgr. A418 (St.)	430503H Preisgr. A418 (St.)



Detailzeichnungen Hohlkehlssockel / Innenecken / Außenecken siehe S. 483

Alle Produkte: Color Shade Variation V2

Treppenfliesen mit Rillierung³

Treppenfliese mit Rillierung 1/3/4/5

Treppenfliese mit Schräge

Treppenfliese mit Schräge & Rillierung 2/3/4/5

Setzstufe

30 x 30 cm



30 x 60 cm¹

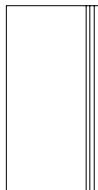

60 x 120 cm **NEU**

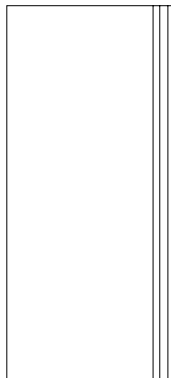

31 x 135 cm²



31 x 135 cm **NEU**

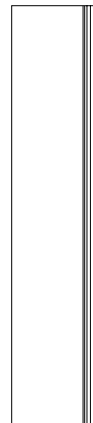

28 x 135 cm



	30 x 30 / 12 x 12	30 x 60 / 12 x 24	60 x 120 / 24 x 48	31 x 135 / 12 13/64 x 53 5/32	31 x 135 / 12 13/64 x 53 5/32	28 x 135 / 11 x 53 5/32	Nennmaß - cm/in
	297 x 297 x 10,5 mm	297 x 597 x 10,5 mm	597 x 1197 x 10,5 mm	307 x 1347 x 10,5 mm	307 x 1347 x 10,5 mm	280 x 1347 x 10,5 mm	Herstellmaß
	eben, matt	eben, matt	gerillt, matt	eben, matt	gerillt, matt	eben, matt	Oberfläche
	3,333	1,667	0,833	0,741	0,741	0,741	m - Stück
	6,943	6,968	14,286	7,321	7,321	6,676	m - kg
	10	6	2	2	2	2	Paket - Stück
	3,000	3,599	2,400	2,699	2,699	2,699	Paket - m
	20,830	25,080	34,300	19,760	19,760	18,020	Paket - kg
	Bla	Bla	Alb	Alb	Alb	Alb	Produktnorm
	R10/A	R10/A	R10/A	R10/A	R10/A	R10/A	Trittsicherheit
	2 - 3	2 - 3	2-3	2 - 3	2-3	2 - 3	Belastung
	430464H Preisgr. A449 (St.)	430504H Preisgr. A475 (St.)	430398H-TF Preisgr. A593 (St.)	430540H Preisgr. A560 (St.)	430540H-TF Preisgr. A577 (St.)	430552H Preisgr. A528 (St.)	anthrazit
	430465H Preisgr. A449 (St.)	430505H Preisgr. A475 (St.)		430541H Preisgr. A560 (St.)		430553H Preisgr. A528 (St.)	basalt
	430466H Preisgr. A449 (St.)	430506H Preisgr. A475 (St.)		430542H Preisgr. A560 (St.)		430554H Preisgr. A528 (St.)	kiesel
	430467H Preisgr. A449 (St.)	430507H Preisgr. A475 (St.)		430543H Preisgr. A560 (St.)		430555H Preisgr. A528 (St.)	stein
	430468H Preisgr. A449 (St.)	430508H Preisgr. A475 (St.)		430544H Preisgr. A560 (St.)		430556H Preisgr. A528 (St.)	sandweiß
	430469H Preisgr. A449 (St.)	430509H Preisgr. A475 (St.)		430545H Preisgr. A560 (St.)		430557H Preisgr. A528 (St.)	sandgrau
	430470H Preisgr. A449 (St.)	430510H Preisgr. A475 (St.)		430546H Preisgr. A560 (St.)		430558H Preisgr. A528 (St.)	sand
	430471H Preisgr. A449 (St.)	430511H Preisgr. A475 (St.)		430547H Preisgr. A560 (St.)		430559H Preisgr. A528 (St.)	muskat
	430472H Preisgr. A449 (St.)	430512H Preisgr. A475 (St.)		430548H Preisgr. A560 (St.)		430560H Preisgr. A528 (St.)	platin
	430473H Preisgr. A449 (St.)	430513H Preisgr. A475 (St.)		430549H Preisgr. A560 (St.)		430561H Preisgr. A528 (St.)	sandbeige
	430474H Preisgr. A449 (St.)	430514H Preisgr. A475 (St.)		430550H Preisgr. A560 (St.)		430562H Preisgr. A528 (St.)	ziegel
	430475H Preisgr. A449 (St.)	430515H Preisgr. A475 (St.)		430551H Preisgr. A560 (St.)		430563H Preisgr. A528 (St.)	lehm



² Nur an den zwei kurzen Seiten kalibriert. Längsseite kann nicht kalibriert werden.

³ Auftragsfertigung: Rückgabe und/oder Stornierung bestellter Ware nicht möglich.

⁴ Auf Anfrage auch in anderen Farben erhältlich

⁵ Details siehe S. 484

Alle Produkte: Color Shade Variation V2



Treppenkanten^{1/2/3/6/7}

4 x 60 cm

7,2 x 60 cm **NEU**7,2 x 120 cm **NEU**Treppenkante mit Schräge^{2/3/6/7}7,2 x 135 cm **NEU**

Sockel, gerundet

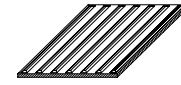
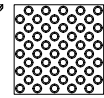
7 x 60 cm¹Blindenleitfliesen^{4/5}30 x 30 cm **NEU**30 x 30 cm **NEU**

Nennmaß - cm/in	4 x 60 / 1 5/8 x 24	7,2 x 60 / 2 7/8 x 24	7,2 x 120 / 2 7/8 x 48	7,2 x 135 / 2 7/8 x 53 5/32	7 x 60 / 2 13/16 x 24	30 x 30 / 12 x 12	30 x 30 / 12 x 12
Herstellmaß	40 x 597 x 10,5 mm	72 x 597 x 10,5 mm	72 x 1197 x 10,5 mm	72 x 1347 x 10,5 mm	70 x 597 x 10,5 mm	297 x 297 x 10,5 mm	297 x 297 x 10,5 mm
Oberfläche	eben, matt	eben, matt	eben, matt	eben, matt	eben, matt	Rippenstruktur	Noppenstruktur
m - Stück	1,667	1,667	0,833	0,741	1,667	3,333	3,333
m - kg	0,967	1,355	1,405	1,380	1,584	7,999	7,999
Paket - Stück	9	9	10	10	15	8	8
Paket - m	5,399	15,003	12,004	13,495	8,998	2,400	2,400
Paket - kg	5,220	7,317	16,870	18,630	14,250	19,200	19,200
Produktnorm	Bla	Bla	Alb	Alb	Bla	Bla	Bla
Trittsicherheit	R10/A	R10/A	R10/A	R10/A		R11	R11
Belastung	2 - 3	2-3	2-3	2-3		3	3
anthrazit	430516H Preisgr. A465 (St.)	430340H-TK Preisgr. A484 (St.)	430398H-TK Preisgr. A511 (St.)	430540H-TK Preisgr. A539 (St.)	430528H Preisgr. A438 (St.)	430304H-R Preisgr. A455 (St.)	430304H-N Preisgr. A539 (St.)
basalt	430517H Preisgr. A465 (St.)				430529H Preisgr. A438 (St.)		
kiesel	430518H Preisgr. A465 (St.)				430530H Preisgr. A438 (St.)		
stein	430519H Preisgr. A465 (St.)				430531H Preisgr. A438 (St.)		
sandweiß	430520H Preisgr. A465 (St.)				430532H Preisgr. A438 (St.)		
sandgrau	430521H Preisgr. A465 (St.)				430533H Preisgr. A438 (St.)		
sand	430522H Preisgr. A465 (St.)				430534H Preisgr. A438 (St.)		
	430523H Preisgr. A465 (St.)				430535H Preisgr. A438 (St.)		
muskat	430524H Preisgr. A465 (St.)				430536H Preisgr. A438 (St.)	430312H-R Preisgr. A455 (St.)	430312H-N Preisgr. A539 (St.)
platin	430525H Preisgr. A465 (St.)				430537H Preisgr. A438 (St.)		
sandbeige	430526H Preisgr. A465 (St.)				430538H Preisgr. A438 (St.)		
ziegel	430527H Preisgr. A465 (St.)				430539H Preisgr. A438 (St.)		
lehm							



1 rektifiziert

2 Nur an den zwei kurzen Seiten kalibriert! Längsseite kann nicht kalibriert werden!

3 Auftragsfertigung: Rückgabe und/oder Stornierung bestellter Ware nicht möglich.



4 Analog den Anforderungen aus DIN 32984

5 Andere Farbkombinationen auf Anfrage unter Berücksichtigung der Vorgaben zum Leuchtdichtekontrast aus DIN 32984

6 Auf Anfrage auch in anderen Farben erhältlich

7 Details siehe S. 484

3D-Rendering / Serie: Area Pro







Vielfalt erleben

Ascona ist wie geschaffen für Spas, Wellnessbereiche und Schwimmbäder in Hotels, aber auch im Privaten. Das liegt auch an der Vielfältigkeit dieser Serie. Schon optisch hat man mit Mosaiken und Riegelformaten, kleinen und großen Formaten für Wand und Boden sowie mit der feinen Auswahl von Farben eine breite Palette für die Gestaltung. Die Serie besticht aber auch mit ihren funktionalen Möglichkeiten und technischen Lösungen, besonders für alle Schwimmbadbereiche oder Spas – übrigens Innen und Außen, in Eingangsbereichen ebenso wie in Räumen, in denen Besucher barfuß unterwegs sind oder in dezidierten Nassbereichen. Dank klarer Linien und geerdeter Farben lassen sich die unterschiedlichsten Stilwelten kreieren. Puristische Architekturen sind ebenso möglich wie klassische oder moderne Landhausgestaltungen. Die Serie Ascona lässt sich perfekt mit unserer neuen Mosaikserie Marble & More kombinieren.



pearl



mud



stone

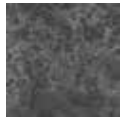

graphite



Bodenfliese 15 x 15 cm, trittsicher R10/B



Bodenfliese 25 x 50 cm, trittsicher R11/B



Rasterprofilfliese 25 x 50 cm, trittsicher R11/C



Schriftplatte 25 x 50 cm, trittsicher R11/B



Bodenfliese 30 x 60 cm, trittsicher R10/A
Bodenfliese 30 x 60 cm, trittsicher R11/B

Mosaik 5 x 5 cm



Mosaikbogen 30 x 30 cm, trittsicher R10/B



Mosaikbogen 30 x 30 cm, trittsicher R10/B



Mosaikbogen 30 x 30 cm, trittsicher R10/B

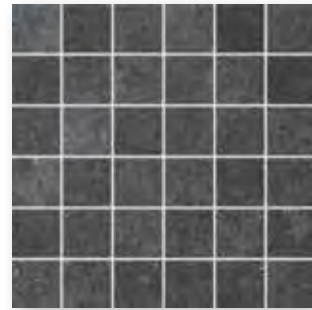

Mosaikbogen 30 x 30 cm, trittsicher R10/B



Bodenfliese 60 x 60 cm, trittsicher R10/A
 Bodenfliese 60 x 60 cm, trittsicher R11/B



Kehlsockel dekoriert, 10 x 50 cm



Kehlsockel dekoriert, 10 x 60 cm



Sockel, geschnitten, 6 x 50 cm



Sockel, geschnitten, 6 x 60 cm



Treppenfliese mit Schräge 31 x 135 cm (rilliert), trittsicher R10/A



Treppenfliese mit Schräge 31 x 135 cm, trittsicher R10/A



Setzstufe 28 x 135 cm



pearl



mud



stone

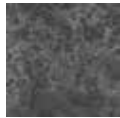

graphite



Bodenfliese 12,5 x 12,5 cm, trittsicher -/B



Bodenfliese 12,5 x 25 cm, trittsicher -/B

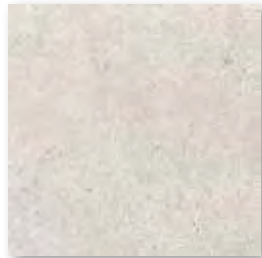

Bodenfliese 25 x 25 cm, trittsicher -/B



Bodenfliese 25 x 50 cm, trittsicher -/B



Wandfliese 12,5 x 25 cm



Wandfliese 25 x 50 cm



Rasterprofilfliese 12,5 x 12,5 cm, trittsicher -/C

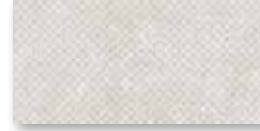

Rasterprofilfliese 12,5 x 25 cm, trittsicher -/C

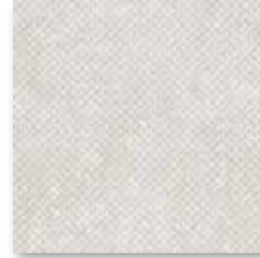

Rasterprofilfliese 25 x 25 cm, trittsicher -/C



Rasterprofilfliese 25 x 50 cm, trittsicher -/C

Rasterprofil



Rillenplatte 12,5 x 25 cm,
trittsicher -/C



Rillenplatte 25 x 25 cm,
trittsicher -/C



Rillenplatte 50 x 25 cm,
trittsicher -/C



Kehlsockel dekoriert, 10 x 25 cm

Flachrinnensystem
(Muldentiefe 5 mm)



Flachrinne*, 25 x 50 cm,
trittsicher -/B



Flachrinne Gehrungspaar,
trittsicher -/B



Flachrinne mit Ablauf,
trittsicher -/B



Endstück,
trittsicher -/B

* Details, siehe Kapitel Pool + Spa auf S. 434 ff (auftragsbezogene Fertigung).



R11/B



pearl



mud



stone

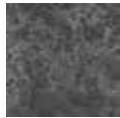

graphite



Terrassenplatte 50 x 100 cm, trittsicher, R11/B



Terrassenplatte 60 x 90 cm, trittsicher, R11/B

Bodenfliesen – 3 mm Fuge

Mosaik

Bodenfliesen

5 x 5 cm¹

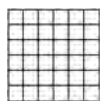

15 x 15 cm



25 x 50 cm²



25 x 50 cm^{2/3}



30 x 60 cm²



30 x 60 cm²



Mosaik, rückseitig
thermoplastisch verklebt
Bogen: 297 x 297 mm

Rasterprofil



	5 x 5 / 2 x 2	15 x 15 / 6 x 6	25 x 50 / 10 x 20	25 x 50 / 10 x 20	30 x 60 / 12 x 24	30 x 60 / 12 x 24	Nennmaß - cm/in
	47 x 47 x 6,5 mm	147 x 147 x 8 mm	247 x 497 x 8 mm	247 x 497 x 8 mm	297 x 597 x 8 mm	297 x 597 x 8 mm	Herstellmaß
	strukturiert, matt	strukturiert, matt	strukturiert, matt	reliefiert, matt	strukturiert, matt	strukturiert, matt	Oberfläche
	11 Bögen	44,444	8,000	8,000	5,556	5,556	m ² - Stück
	12,331	17,555	17,040	17,040	17,413	17,413	m ² - kg
	11	35	9	9	6	6	Paket - Stück
	1,000	0,788	1,125	1,125	1,080	1,080	Paket - m ²
	12,331	13,825	19,170	19,170	18,804	18,804	Paket - kg
	64,000	63,001	40,500	40,500	43,197	43,197	Palette - m ²
	789,184	1.106,000	690,120	690,120	752,160	752,160	Palette - kg
	Bla	Bla	Alb	Alb	Alb	Alb	Produktnorm
	R10/B	R10/B	R11/B	R11/C	R10/A	R11/B	Trittsicherheit
	2	2	2	2	2	2	Belastung
	430701H	430705H	430709H	<i>430713H</i>	430721H	430725H	pearl
	Preisgr. A197 (m ²)	Preisgr. A125 (m ²)	Preisgr. A139 (m ²)	<i>Preisgr. A162 (m²)</i>	Preisgr. A119 (m ²)	Preisgr. A125 (m ²)	
	430702H	430706H	430710H	<i>430714H</i>	430722H	430726H	mud
	Preisgr. A197 (m ²)	Preisgr. A125 (m ²)	Preisgr. A139 (m ²)	<i>Preisgr. A162 (m²)</i>	Preisgr. A119 (m ²)	Preisgr. A125 (m ²)	
	430703H	430707H	430711H	<i>430715H</i>	430723H	430727H	stone
	Preisgr. A197 (m ²)	Preisgr. A125 (m ²)	Preisgr. A139 (m ²)	<i>Preisgr. A162 (m²)</i>	Preisgr. A119 (m ²)	Preisgr. A125 (m ²)	
	430704H	430708H	430712H	<i>430716H</i>	430724H	430728H	graphite
	Preisgr. A197 (m ²)	Preisgr. A125 (m ²)	Preisgr. A139 (m ²)	<i>Preisgr. A162 (m²)</i>	Preisgr. A119 (m ²)	Preisgr. A125 (m ²)	



2 rektifiziert



3 Auftragsfertigung: Rückgabe und/oder Stornierung bestellter Ware nicht möglich.



Alle Produkte: Color Shade Variation V3



Bodenfliesen – 3 mm Fuge

Bodenfliesen¹

60 x 60 cm

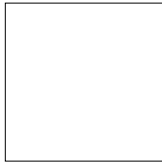

60 x 60 cm

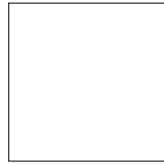
Treppenfliese mit Rillierung^{2/3}

31 x 135 cm



31 x 135 cm

Setzstufe^{2/3}

28 x 135 cm



Nennmaß - cm/in	60 x 60 / 24 x 24	60 x 60 / 24 x 24	31 x 135 / 12 13/64 x 53 5/32	31 x 135 / 12 13/64 x 53 5/32	28 x 135 / 11 x 53 5/32		
Herstellmaß	597 x 597 x 8 mm	597 x 597 x 8 mm	307 x 1347 x 10,5 mm	307 x 1347 x 10,5 mm	280 x 1347 x 10,5 mm		
Oberfläche	strukturiert, matt	strukturiert, matt	strukturiert, matt	strukturiert, matt	strukturiert, matt		
m ² /m - Stück	2,778/m ²	2,778/m ²	0,741/m	0,741/m	0,741/m		
m ² /m - kg	18,001/m ²	18,001/m ²	7,321/m	7,321/m	6,676/m		
Paket - Stück	4	4	2	2	2		
Paket - m ² /m	1,440/m ²	1,440/m ²	2,669/m	2,669/m	2,669/m		
Paket - kg	25,920	25,920	19,760	19,760	18,020		
Palette - m ²	43,197	43,197					
Palette - kg	777,600	777,600					
Produktnorm	Alb	Alb	Alb	Alb	Alb		
Trittsicherheit	R10/A	R11/B	R10/A	R10/A			
Belastung	2	2	2 - 3	2 - 3	2 - 3		
pearl	430729H Preisgr. A139 (m ²)	430733H Preisgr. A155 (m ²)	430980H Preisgr. A577 (St.)	430745H Preisgr. A560 (St.)	430749H Preisgr. A528 (St.)		
mud	430730H Preisgr. A139 (m ²)	430734H Preisgr. A155 (m ²)	430981H Preisgr. A577 (St.)	430746H Preisgr. A560 (St.)	430750H Preisgr. A528 (St.)		
stone	430731H Preisgr. A139 (m ²)	430735H Preisgr. A155 (m ²)	430982H Preisgr. A577 (St.)	430747H Preisgr. A560 (St.)	430751H Preisgr. A528 (St.)		
graphite	430732H Preisgr. A139 (m ²)	430736H Preisgr. A155 (m ²)	430983H Preisgr. A577 (St.)	430748H Preisgr. A560 (St.)	430752H Preisgr. A528 (St.)		

Kehlsockel dekoriert^{1/2}

10 x 50 cm



10 x 60 cm

Sockel, geschnitten¹

6 x 50 cm



6 x 60 cm

Schriftplatte^{1/2/4}

25 x 50 cm

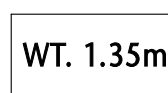

Nennmaß - cm/in	10 x 50 / 4 x 20	10 x 60 / 4 x 24	6 x 50 / 2 3/8 x 20	6 x 60 / 2 3/8 x 24	25 x 50 / 10 x 20		
Herstellmaß	100 x 497/35 x 9 mm	100 x 597/35 x 9 mm	60 x 497 x 8 mm	60 x 597 x 8 mm	247 x 497 x 8 mm		
Oberfläche	strukturiert, matt	strukturiert, matt	strukturiert, matt	strukturiert, matt	strukturiert, matt		
m - Stück	2,000	1,667	2,000	1,667	2,000		
m/St. - kg	2,000/m	2,000/m	1,098/m	1,100/m	2,130/Stück		
Paket - Stück	20	20	30	34			
Paket - m	10,000	12,000	15,000	20,396			
Paket - kg	20,000	24,000	16,470	22,440			
Palette - m ²							
Palette - kg							
Produktnorm	Alb	Alb	Alb	Alb	Alb		
Trittsicherheit					R11/B		
Belastung					2		
pearl	430741H Preisgr. A441 (St.)	430737H Preisgr. A445 (St.)	430984H Preisgr. A434 (St.)	430988H Preisgr. A434 (St.)	430717H Preisgr. A668 (St.)		
mud	430742H Preisgr. A441 (St.)	430738H Preisgr. A445 (St.)	430985H Preisgr. A434 (St.)	430989H Preisgr. A434 (St.)	430718H Preisgr. A668 (St.)		
stone	430743H Preisgr. A441 (St.)	430739H Preisgr. A445 (St.)	430986H Preisgr. A434 (St.)	430990H Preisgr. A434 (St.)	430719H Preisgr. A668 (St.)		
graphite	430744H Preisgr. A441 (St.)	430740H Preisgr. A445 (St.)	430987H Preisgr. A434 (St.)	430991H Preisgr. A434 (St.)	430720H Preisgr. A668 (St.)		

Schrifthöhe 7cm



Alle Produkte: Color
Shade Variation V3

² Auftragsfertigung: Rückgabe und/oder Stornierung
bestellter Ware nicht möglich.

³ Nur an den zwei kurzen Seiten rektifiziert! Längsseite kann nicht
rektifiziert werden!

⁴ nur Ziffern / Buchstaben in der Farbe 91 machbar!

Wand- und Bodenfliesen – 6 mm Fuge

Wandfliese Bodenfliesen

12,5 x 25 cm



12,5 x 12,5 cm



12,5 x 12,5 cm¹



12,5 x 25 cm



12,5 x 25 cm¹



25 x 25 cm



25 x 25 cm¹



Lieferung als Doppelplatte; müssen örtlich gebrochen werden

Rasterprofil
Lieferung als Doppelplatte; müssen örtlich gebrochen werden

Rasterprofil

Rasterprofil

12,5 x 25 / 5 x 10	12,5 x 12,5 / 5 x 5	12,5 x 12,5 / 5 x 5	12,5 x 25 / 5 x 10	12,5 x 25 / 5 x 10	25 x 25 / 10 x 10	25 x 25 / 10 x 10	Nennmaß - cm/in
119 x 244 x 8 mm	119 x 119 x 8 mm	119 x 119 x 8 mm	119 x 244 x 8 mm	119 x 244 x 8 mm	244 x 244 x 8 mm	244 x 244 x 8 mm	Herstellmaß
strukturiert, matt	strukturiert, matt	reliefiert, matt	strukturiert, matt	reliefiert, matt	strukturiert, matt	reliefiert, matt	Oberfläche
32,000	64,000	64,000	32,000	32,000	16,000	16,000	m ² - Stück
15,680	15,360	15,360	15,680	15,680	16,960	16,800	m ² - kg
33	66	66	33	33	14	14	Paket - Stück
1,031	1,031	1,031	1,031	1,031	0,875	0,875	Paket - m ²
16,170	15,840	15,840	16,170	16,170	14,840	14,700	Paket - kg
86,625	86,625	86,625	86,625	86,625	70,875	70,875	PaLETTE - m ²
1.358,280	1.330,560	1.330,560	1.358,280	1.358,280	1.202,040	1.190,700	PaLETTE - kg
Alb	Alb	Alb	Alb	Alb	Alb	Alb	Produktnorm
-	- /B	- /C	- /B	- /C	- /B	- /C	Trittsicherheit
2	2	2	2	2	2	2	Belastung
430761H	430753H	430757H	430763H	430767H	430771H	430775H	pearl
Preisgr. A94 (m ²)	Preisgr. A139 (m ²)	Preisgr. A139 (m ²)	Preisgr. A101 (m ²)	Preisgr. A119 (m ²)	Preisgr. A150 (m ²)	Preisgr. A110 (m ²)	
	430754H	430758H	430764H	430768H	430772H	430776H	mud
	Preisgr. A139 (m ²)	Preisgr. A139 (m ²)	Preisgr. A101 (m ²)	Preisgr. A119 (m ²)	Preisgr. A150 (m ²)	Preisgr. A110 (m ²)	
	430755H	430759H	430765H	430769H	430773H	430777H	stone
	Preisgr. A139 (m ²)	Preisgr. A139 (m ²)	Preisgr. A101 (m ²)	Preisgr. A119 (m ²)	Preisgr. A150 (m ²)	Preisgr. A110 (m ²)	
430762H	430756H	430760H	430766H	430770H	430774H	430778H	graphite
Preisgr. A94 (m ²)	Preisgr. A139 (m ²)	Preisgr. A139 (m ²)	Preisgr. A101 (m ²)	Preisgr. A119 (m ²)	Preisgr. A150 (m ²)	Preisgr. A110 (m ²)	



Wandfliese² Bodenfliesen²

25 x 50 cm

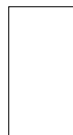

25 x 50 cm



25 x 50 cm¹



50 x 25 cm³

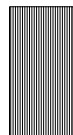

25 x 25 cm



12,5 x 25 cm



Rasterprofil

25 x 50 / 10 x 20	25 x 50 / 10 x 20	25 x 50 / 10 x 20	50 x 25 / 20 x 10	25 x 25 / 10 x 10	12,5 x 25 / 5 x 10	Nennmaß - cm/in
244 x 494 x 8 mm	244 x 494 x 8 mm	244 x 494 x 8 mm	494 x 244 x 12,5 mm	244 x 244 x 12,5 mm	119 x 244 x 12,5 mm	Herstellmaß - mm
strukturiert, matt	strukturiert, matt	reliefiert, matt	gerillt, matt	gerillt, matt	gerillt, matt	Oberfläche
8,000/m ²	8,000/m ²	8,000/m ²	2,000/m	4,000/m	8,000/m	m ² /m - Stück
17,040/m ²	17,040/m ²	17,040/m ²	3,550/Stück	1,775/Stück	0,888/Stück	m ² /St. - kg
9	9	9	6	9	21	Paket - Stück
1,125/m ²	1,125/m ²	1,125/m ²	3,000/m	2,250/m	2,625/m	Paket - m ² / m
19,170	19,170	19,170	21,300	15,975	18,648	Paket - kg
40,500	40,500	40,500				Paket - m ²
690,120	690,120	690,120				PaLETTE - kg
Alb	Alb	Alb	Alb	Alb	Alb	Produktnorm
-	- /B	- /C	- /C	- /C	- /C	Trittsicherheit
-	2	2				Belastung
430779H	430781H	430785H	430789H	430793H	430802H	pearl
Preisgr. A125 (m ²)	Preisgr. A139 (m ²)	Preisgr. A162 (m ²)	Preisgr. A560 (St.)	Preisgr. A480 (St.)	Preisgr. A430 (St.)	
	430782H	430786H	430790H	430794H	430803H	mud
	Preisgr. A139 (m ²)	Preisgr. A162 (m ²)	Preisgr. A560 (St.)	Preisgr. A480 (St.)	Preisgr. A430 (St.)	
	430783H	430787H	430791H	430795H	430804H	stone
	Preisgr. A139 (m ²)	Preisgr. A162 (m ²)	Preisgr. A560 (St.)	Preisgr. A480 (St.)	Preisgr. A430 (St.)	
430780H	430784H	430788H	430792H	430796H	430805H	graphite
Preisgr. A125 (m ²)	Preisgr. A139 (m ²)	Preisgr. A162 (m ²)	Preisgr. A560 (St.)	Preisgr. A480 (St.)	Preisgr. A430 (St.)	



¹ Auftragsfertigung: Rückgabe und/oder Stornierung bestellter Ware nicht möglich.

Alle Produkte: Color Shade Variation V3

² rektifiziert

³ Kopfkante rektifiziert

Kehlsockel
dekoriert^{1/3}

10 x 25 cm

Flachrinnensystem²

25 x 50 cm



25 x 50 cm

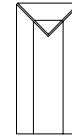
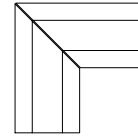
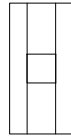

Flachrinne

Flachrinne mit Ablauf
110 / 110 mmFlachrinne
Gehrungspaar

Flachrinne Endstück

Nennmaß - cm/in	10 x 25 / 4 x 10	25 x 50 / 10 x 20	25 x 50 / 10 x 20	(2x) 244 x 494 x 14 mm	244 x 494 x 14 mm
Herstellmaß - mm	100 x 244/35 x 9 mm	244 x 494 x 14 mm	244 x 494 x 14 mm	(2x) 244 x 494 x 14 mm	244 x 494 x 14 mm
Oberfläche	strukturiert, matt	strukturiert, matt	strukturiert, matt	strukturiert, matt	strukturiert, matt
m - Stück	4,000	2,000	2,300/Stück	3,800/Paar	2,500/Stück
m/St./Paar - kg	0,500/Stück	5,000/m	2,300/Stück	3,800/Paar	2,500/Stück
Paket - St./Paar	20 Stück	5 Stück	5 Stück	2 Paar	5 Stück
Paket - m		2,500			
Paket - kg	10,000	12,500	11,500	7,600	12,500
Palette - m ²					
Palette - kg					
Produktnorm	Alb	Alb	Alb	Alb	Alb
Trittsicherheit		- /B	- /B	- /B	- /B
pearl	430806H Preisgr. A423 (St.)	430810H Preisgr. A519 (St.)	430814H Preisgr. A593 (St.)	430818H Preisgr. A645 (Paar)	430822H Preisgr. A593 (St.)
mud	430807H Preisgr. A423 (St.)	430811H Preisgr. A519 (St.)	430815H Preisgr. A593 (St.)	430819H Preisgr. A645 (Paar)	430823H Preisgr. A593 (St.)
stone	430808H Preisgr. A423 (St.)	430812H Preisgr. A519 (St.)	430816H Preisgr. A593 (St.)	430820H Preisgr. A645 (Paar)	430824H Preisgr. A593 (St.)
graphite	430809H Preisgr. A423 (St.)	430813H Preisgr. A519 (St.)	430817H Preisgr. A593 (St.)	430821H Preisgr. A645 (Paar)	430825H Preisgr. A593 (St.)

Terrassenplatten – 3 mm Fuge^{1/4}

50 x 100 cm



60 x 90 cm

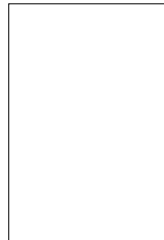

Nennmaß - cm/in	50 x 100 / 20 x 40	60 x 90 / 24 x 36			
Herstellmaß - mm	497 x 997 x 20 mm	597 x 897 x 20 mm			
Oberfläche	strukturiert, matt	strukturiert, matt			
m ² - Stück	2,000	1,851			
m ² - kg	43,060	43,128			
Paket - Stück	1	1			
Paket - m ²	0,500	0,540			
Paket - kg	21,530	23,300			
Palette - m ²	22,500	11,345			
Palette - kg	968,850	489,300			
Produktnorm	Alla	Alla			
Trittsicherheit	R11/B	R11/B			
Belastung	3	3			
pearl	4 430826H Preisgr. A169 (m ²)	430830H Preisgr. A157 (m ²)			
mud	4 430827H Preisgr. A169 (m ²)	430831H Preisgr. A157 (m ²)			
stone	4 430828H Preisgr. A169 (m ²)	430832H Preisgr. A157 (m ²)			
graphite	4 430829H Preisgr. A169 (m ²)	430833H Preisgr. A157 (m ²)			

¹ rektifiziert² Auf Anfrage auch in 497 mm Länge machbar³ Auftragsfertigung: Rückgabe und/oder Stornierung bestellter Ware nicht möglich.⁴ Hohes Gewicht! Karton bitte nur zu Zweit transportieren.

Alle Produkte: Color Shade Variation V3



3D-Rendering / Serie: Ascona





3D-Rendering / Serie: Basic Stone





Modern und langlebig

Inspiziert von Schieferstrukturen entstand Basic Stone. Die keramische Oberfläche des 5 x 5 cm Mosaiks aus unglasiertem Feinsteinzeug mit Hytect-Oberfläche stellt das Thema Schiefer durch einen Reliefmix in Kombination mit dezenter Graphik modern und gleichzeitig langlebig dar. Feine Glanzpunkte aus Glimmer und dezente Farbkontraste unterstützen den steinigen Charakter der Oberfläche. Die Farbpalette orientiert sich an natürlichen Schieferfarben.

Mosaik, non-slip 5 x 5 cm



schwarz

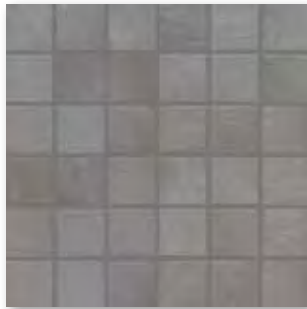

mittelgrau



hellgrau

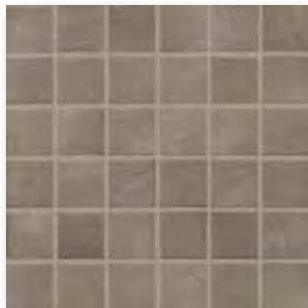

schlamm



beige

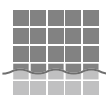

Rückseitig thermoplastisch verklebte Mosaik von AGROB BUCHTAL sind nicht nur im Trockenbereich, sondern auch bedenkenlos im Unterwasserbereich (z. B. Schwimmbecken/Whirlpool) sowie im dauernassbelasteten Bereich (z. B. Beckenumgänge/Duschen) einsetzbar.

Mosaik

5 x 5 cm



Mosaik, rückseitig
thermoplastisch verklebt
Bogen: 297 x 297 mm



					5 x 5 / 2 x 2	Nennmaß - cm/in
					47 x 47 x 6,5 mm	Herstellmaß
					strukturiert, matt	Oberfläche
					11 Bögen	m ² - Stück
					12,331	m ² - kg
					11 Bögen	Paket - Stück
					1,000	Paket - m ²
					12,331	Paket - kg
					64,000	Palette - m ²
					789,184	Palette - kg
					Bla	Produktnorm
					R10/B	Trittsicherheit
					1 - 2	Belastung
					42200H-73	
					Preisgr. A197 (m ²)	schwarz
					42201H-73	
					Preisgr. A197 (m ²)	mittelgrau
					42202H-73	
					Preisgr. A197 (m ²)	hellgrau
					42203H-73	
					Preisgr. A197 (m ²)	schlamm
					42204H-73	
					Preisgr. A197 (m ²)	beige

Color Shade Variation: V2







Zeitlos und schlicht

Die zeitlose Farbpalette und Formate von 5 x 5 cm bis 35 x 100 cm erlauben wirtschaftliche Lösungen in unterschiedlichen Bereichen. Die neue Serienergänzung Basis Pro erweitert das Angebot um ein Sortiment an Feinsteinzeug-Bodenfliesen in zeitgemäßem und langlebigem Design. Weiterer Pluspunkt: die hohen Trittsicherheiten von R10/A über R11/B bis R13V10. Duschtassensysteme, Treppenfliessen und Formteile ergänzen das Angebot.



Basis 1
Steingut,
glasiert

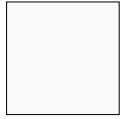

weiß, glänzend



weiß, matt



weiß matt und glänzend gewellt



weiß glänzend, gehämmert



hellgrau marmoriert, glänzend und matt



beige marmoriert, glänzend und matt



sandbeige glänzend und matt



elfenbein, glänzend

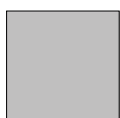

hellgrau, matt

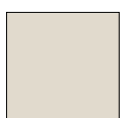

hellbeige, matt



Listel Candy
4,5 x 20 cm

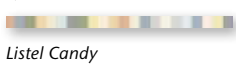

Listel Candy
1 x 20 cm

Basis 1+
Steingut,
glasiert



weiß, glänzend



weiß, matt



weiß, glänzend gewellt



weiß, matt gewellt

Basis 2
Steinzeug,
glasiert

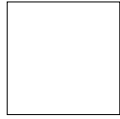

weiß, matt



weiß, glänzend

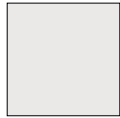

grau, matt



hellgrau, matt

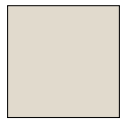

hellbeige, matt

Basis 3
Feinsteinzeug,
unglasiert



titanit



anthrazit



mittelgrau



kreide



eben
R10/A und R10/B



Softcorn 2
R11/B



Perlstic
R12



Opticorn
R12V4



Picstic
R12V8

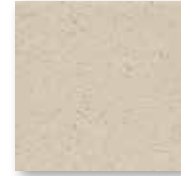

Geraut
R13



Kombicorn
R13V10

Basis 4
Steinzeugplatten,
glasiert



weiß, glänzend



weiß, matt



grau transparent, matt



lichtgrau, matt



lichtsahara,
matt



softazur,
glänzend



lichtblau,
glänzend



azurdunkel,
glänzend

Wandfliesen

15 x 15 cm



15 x 15 cm



15 x 30 cm **NEU**



20 x 20 cm



20 x 25 cm



20 x 40 cm



20 x 60 cm



15 x 15 / 6 x 6	15 x 15 / 6 x 6	15 x 30 cm / 6 x 12	20 x 20 / 8 x 8	20 x 25 / 8 x 10	20 x 40 / 8 x 16	20 x 60 / 8 x 24	Nennmaß - cm/in
150 x 150 x 5,0 mm	147 x 147 x 5,0 mm	147 x 297 x 6,5 mm	197 x 197 x 6,0 mm	198 x 248 x 6,0 mm	197 x 397 x 7,5 mm	197 x 597 x 9,0 mm	Herstellmaß
eben	eben	eben	eben	eben	eben	eben	Oberfläche
44,000	44,000	22,222	25,000	20,000	12,500	8,333	m ² - Stück
9,812	9,812	9,955	10,800	10,620	12,638	15,516	m ² - kg
44	44	24	25	20	16	8	Paket - Stück
1,000	1,000	1,080	1,000	1,000	1,280	0,960	Paket - m ²
9,812	9,812	10,752	10,800	10,620	16,176	14,896	Paket - kg
105,000	105,000	91,801	96,000	92,000	92,160	61,442	Palette - m ²
1.030,260	1.030,260	913,920	1.036,800	977,040	1.164,672	953,344	Palette - kg
BIII	BIII	BIII	BIII	BIII	BIII	BIII	Produktnorm
112000	531910-148	173368	532230-800	538020-400	182763	381474	
Preisgr. A24 (m ²)	Preisgr. A24 (m ²)	Preisgr. A55 (m ²)	Preisgr. A24 (m ²)	Preisgr. A31 (m ²)	Preisgr. A40 (m ²)	Preisgr. A81 (m ²)	weiß, glänzend
115100	531911-148	173369	532212-800	538021-400	182764	381475	
Preisgr. A24 (m ²)	Preisgr. A24 (m ²)	Preisgr. A55 (m ²)	Preisgr. A24 (m ²)	Preisgr. A31 (m ²)	Preisgr. A40 (m ²)	Preisgr. A81 (m ²)	weiß, matt
							weiß, glänzend, gewellt
							weiß, matt, gewellt
113063							weiß, glänzend, gehämmert
Preisgr. A67 (m ²)							elfenbein, glänzend
111052							hellgrau marmoriert, glänzend
Preisgr. A67 (m ²)							hellgrau marmoriert, matt
				538260-400			beige marmoriert, glänzend
				Preisgr. A31 (m ²)			beige marmoriert, matt
				538261-400			hellgrau marmoriert, glänzend
				Preisgr. A31 (m ²)			hellgrau marmoriert, matt
				538280-400			beige marmoriert, glänzend
				Preisgr. A31 (m ²)			beige marmoriert, matt
				538281-400			hellgrau, matt NEU
				Preisgr. A31 (m ²)			hellgrau, matt
		173339	213341		183343		hellbeige, matt NEU
		Preisgr. A67 (m ²)	Preisgr. A40 (m ²)		Preisgr. A55 (m ²)		hellbeige, matt
		173340	213342		183344		hellbeige, matt
		Preisgr. A67 (m ²)	Preisgr. A40 (m ²)		Preisgr. A55 (m ²)		hellbeige, matt

Wandfliesen

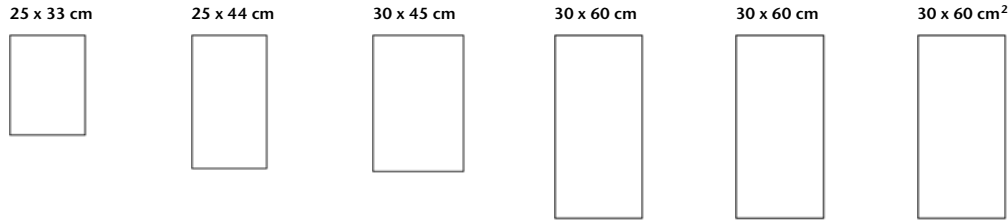

Nennmaß - cm/in	25 x 33 / 10 x 13	25 x 44 / 10 x 17 5/8	30 x 45 / 12 x 18	30 x 60 / 12 x 24	30 x 60 / 12 x 24	30 x 60 / 12 x 24	
Herstellmaß	249 x 330 x 8,0 mm	249 x 441 x 9,0 mm	298 x 448 x 9,0 mm	297 x 597 x 9,0 mm	297 x 597 x 6,0 mm	297 x 597 x 9,0 mm	
Oberfläche	eben	eben	eben	eben	eben	eben	
m ² - Stück	12,121	9,000	7,407	5,556	5,556	5,556	
m ² - kg	12,969	15,498	15,000	14,946	10,279	14,890	
Paket - Stück	13	10	9	9	13	9	
Paket - m ²	1,073	1,111	1,215	1,620	2,339	1,620	
Paket - kg	13,910	17,220	18,225	24,210	24,050	24,120	
Palette - m ²	80,439	63,333	72,904	77,754	112,311	77,754	
Palette - kg	1.043,250	981,540	1.093,500	1.162,080	1.154,444	1.157,760	
Produktnorm	BIII	BIII	BIII	BIII	BIII	BIII	
weiß, glänzend	239996 Preisgr. A31 (m ²)	269478 Preisgr. A40 (m ²)	229480 Preisgr. A55 (m ²)	280374 Preisgr. A81 (m ²)	203264 Preisgr. A81 (m ²)	282115R-02 Preisgr. A94 (m ²)	
weiß, matt	239995 Preisgr. A31 (m ²)	269479 Preisgr. A40 (m ²)	229481 Preisgr. A55 (m ²)	280375 Preisgr. A81 (m ²)	203265 Preisgr. A81 (m ²)	282116R-02 Preisgr. A94 (m ²)	
weiß, glänzend, gewellt	239998 Preisgr. A31 (m ²)		229482 Preisgr. A55 (m ²)	280718 Preisgr. A81 (m ²)			
weiß, matt, gewellt	239997 Preisgr. A31 (m ²)		229483 Preisgr. A55 (m ²)	280719 Preisgr. A81 (m ²)			
sandbeige, glänzend				280871 Preisgr. A67 (m ²)			
sandbeige, matt				280872 Preisgr. A67 (m ²)			
hellgrau, matt NEU				283345 Preisgr. A110 (m ²)			
hellbeige, matt NEU				283346 Preisgr. A110 (m ²)			
hellgrau marmoriert, glänzend	231032 Preisgr. A31 (m ²)						
hellgrau marmoriert, matt	231034 Preisgr. A31 (m ²)						



Wandfliesen¹

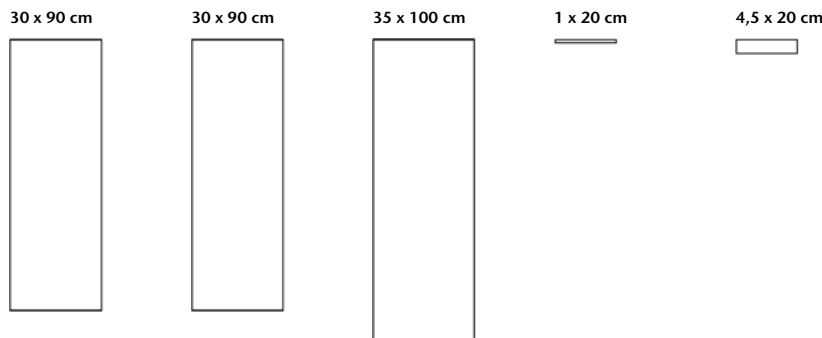

Listel

Nennmaß - cm/in	30 x 90 / 12 x 36	30 x 90 / 12 x 36	35 x 100 / 14 x 40	1 x 20 / 3/8 x 8	4,5 x 20 / 1 13/16 x 8		
Herstellmaß	297 x 897 x 6,0 mm	297 x 897 x 10,5 mm	347 x 997 x 6 mm	10 x 197 x 6,0 mm	45 x 197 x 6,0 mm		
Oberfläche	eben	eben	eben	eben, seidenmatt	eben, seidenmatt		
m ² /m - Stück	3,704/m ²	3,704/m ²	2,857/m ²	5,000/m	5,000/m		
m ² /m - kg	10,400/m ²	17,976/m ²	10,513/m ²	0,125/m	0,505/m		
Paket - Stück	8	5	5	100	72		
Paket - m ² /m	2,160 m ²	1,350 m ²	1,750 m ²	20,000 m	14,400 m		
Paket - kg	22,464	24,265	18,400	2,500	7,272		
Palette - m ²	51,836	32,397	70,000				
Palette - kg	539,094	582,360	736,000				
Produktnorm	BIII	BIII	BIII	BIII	BIII		
candy				533436-198 Preisgr. A414 (St.)	533434-198 Preisgr. A431 (St.)		
weiß, glänzend	323260 Preisgr. A101 (m ²)	391589 Preisgr. A101 (m ²)	363335 Preisgr. A119 (m ²)				
weiß, matt	323261 Preisgr. A101 (m ²)	391590 Preisgr. A101 (m ²)	363336 Preisgr. A119 (m ²)				

¹ Kanten geschliffen

Wandfliesen

25 x 44 cm



30 x 45 cm



20 x 60 cm



30 x 60 cm



30 x 60 cm²



30 x 90 cm¹



	25 x 44 / 10 x 17 5/8	30 x 45 / 12 x 18	20 x 60 / 8 x 24	30 x 60 / 12 x 24	30 x 60 / 12 x 24	30 x 90 / 12 x 36	Nennmaß - cm/in
	249 x 441 x 9,0 mm	298 x 448 x 9,0 mm	197 x 597 x 9,0 mm	297 x 597 x 9,0 mm	297 x 597 x 9,0 mm	297 x 897 x 10,5 mm	Herstellmaß
	eben	eben	eben	eben	eben	eben	Oberfläche
	9,000	7,407	8,333	5,556	5,556	3,704	m ² - Stück
	15,498	15,000	15,516	14,946	14,890	17,976	m ² - kg
	10	9	8	9	9	5	Paket - Stück
	1,111	1,215	0,960	1,620	1,620	1,350	Paket - m ²
	17,220	18,225	14,896	24,210	24,120	24,265	Paket - kg
	63,333	72,904	61,442	77,754	77,754	32,397	PaLETTE - m ²
	981,540	1.093,500	953,344	1.162,080	1.157,760	582,360	PaLETTE - kg
	BIII	BIII	BIII	BIII	BIII	BIII	Produktnorm
	268099	228522	381467	289358	282887R	391572	
	Preisgr. A67 (m ²)	Preisgr. A81 (m ²)	Preisgr. A113 (m ²)	Preisgr. A113 (m ²)	Preisgr. A125 (m ²)	Preisgr. A125 (m ²)	weiß, glänzend
	260713	228523	381468	289359	282888R	391573	
	Preisgr. A67 (m ²)	Preisgr. A81 (m ²)	Preisgr. A113 (m ²)	Preisgr. A113 (m ²)	Preisgr. A125 (m ²)	Preisgr. A125 (m ²)	weiß, matt
		228845		289360			weiß, glänzend, gewellt
		Preisgr. A81 (m ²)		Preisgr. A113 (m ²)			weiß, matt, gewellt
				289361			
				Preisgr. A113 (m ²)			

¹ Kanten geschliffen

² rektifiziert



Wandfliesen

30 x 60 cm



30 x 90 cm¹



35 x 100¹



				30 x 60 / 12 x 24	30 x 90 / 12 x 36	35 x 100 / 14 x 40	Nennmaß - cm/in
				297 x 597 x 6,0 mm	297 x 897 x 6 mm	347 x 997 x 6 mm	Herstellmaß
				eben	eben	eben	Oberfläche
				5,556	3,704	2,857	m ² - Stück
				10,279	10,400	10,513	m ² - kg
				13	8	5	Paket - Stück
				2,339	2,160	1,750	Paket - m ²
				24,050	22,464	18,400	Paket - kg
				112,311	51,836	70,000	PaLETTE - m ²
				1.154,444	539,094	736,000	PaLETTE - kg
				BIII	BIII	BIII	Produktnorm
				203266H	323262H	363337H	
				Preisgr. A113 (m ²)	Preisgr. A125 (m ²)	Preisgr. A139 (m ²)	weiß, glänzend
				203267H	323263H	363338H	
				Preisgr. A113 (m ²)	Preisgr. A125 (m ²)	Preisgr. A139 (m ²)	weiß, matt

¹ Kanten geschliffen

Wand-/Bodenfliesen

Kehlsockel

10 x 10 cm¹

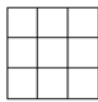

10 x 10 cm¹

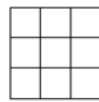

15 x 15 cm



20 x 20 cm



30 x 60 cm³ **NEU**



10 x 10 cm²



Mosaik, rückseitig
thermoplastisch
verklebt
Bogen: 297 x 297 mm

Mosaik, rückseitig
thermoplastisch
verklebt
Bogen: 297 x 297 mm

Nennmaß - cm/in	10 x 10 / 4 x 4	10 x 10 / 4 x 4	15 x 15 / 6 x 6	20 x 20 / 8 x 8	30 x 60 / 12 x 24	10 x 10 / 4 x 4
Herstellmaß	97 x 97 x 6,5 mm	97 x 97 x 6,5 mm	147 x 147 x 6,5 mm	197 x 197 x 6,5 mm	297 x 597 x 8,0 mm	100 x 97 x 6,0 mm
Oberfläche	eben, matt	eben, matt	eben, matt	eben, matt	eben	eben, matt
m ² /m - Stück	11 Bögen/m ²	11 Bögen/m ²	44,000/m ²	25,000/m ²	5,556/m ²	10,000/m
m ² /m - kg	13,101/m ²	13,101/m ²	13,816/m ²	13,875/m ²	17,413/m ²	1,500/m
Paket - Stück	11 Bögen	11 Bögen	44	25	6	40
Paket - m ² /m	1,000 m ²	1,000 m ²	1,000 m ²	1,000 m ²	1,080 m ²	6,000 m
Paket - kg	13,101	13,101	13,816	13,875	18,804	5,600
Palette - m ²	64,000	64,000	80,000	72,000	43,197	
Palette - kg	838,464	838,464	1.105,280	999,000	752,242	
Produktnorm	Blb	Blb	Blb	Blb	Alb	Blb
Trittsicherheit		R10/B				R10/B
Belastung	1 - 2	1 - 2	1 - 2	1 - 2	1 - 2	
weiß matt	4 620811-504 Preisgr. A81 (m ²)	600859-504 Preisgr. A113 (m ²)	620805-504 Preisgr. A61 (m ²)	620806-504 Preisgr. A60 (m ²)	430964 Preisgr. A113 (m ²)	600864-504 Preisgr. A414 (St.)
weiß glänzend NEU					430963 Preisgr. A113 (m ²)	
grau	4 620811-505 Preisgr. A81 (m ²)	600859-505 Preisgr. A113 (m ²)	620805-505 Preisgr. A61 (m ²)	620806-505 Preisgr. A60 (m ²)		600864-505 Preisgr. A414 (St.)
hellgrau matt NEU				430967 Preisgr. A81 (m ²)	430965 Preisgr. A139 (m ²)	
hellbeige matt NEU				430968 Preisgr. A81 (m ²)	430966 Preisgr. A139 (m ²)	



3 rektifiziert

² Details siehe S. 483

Wand-/Bodenfliesen

5 x 5 cm¹



Mosaik, rückseitig
thermoplastisch verklebt
Bogen: 297 x 297 mm

10 x 10 cm¹



Mosaik, rückseitig
thermoplastisch verklebt
Bogen: 297 x 297 mm

15 x 15 cm



Micro

15 x 15 cm



Softcorn 2

20 x 20 cm



Micro

20 x 20 cm



Softcorn 2

20 x 20 cm



Perlstick



protected

5 x 5 / 2 x 2	10 x 10 / 4 x 4	15 x 15 / 6 x 6	15 x 15 / 6 x 6	20 x 20 / 8 x 8	20 x 20 / 8 x 8	20 x 20 / 8 x 8	Nennmaß - cm/in
47 x 47 x 6,5 mm	97 x 97 x 6,5 mm	147 x 147 x 10,5 mm	147 x 147 x 10,5 mm	197 x 197 x 9,0 mm	197 x 197 x 9,0 mm	197 x 197 x 9,0 mm	Herstellmaß
eben, matt	eben, matt	eben, matt	strukturiert, matt	eben, matt	strukturiert, matt	gekörnt, matt	Oberfläche
11 Bögen	11 Bögen	44,444	44,444	25,000	25,000	25,000	m ² - Stück
12,331	13,101	23,111	23,111	19,450	19,450	19,450	m ² - kg
11 Bögen	11 Bögen	27	27	25	25	25	Paket - Stück
1,000	1,000	0,608	0,608	1,000	1,000	1,000	Paket - m ²
12,331	13,101	14,040	14,040	19,450	19,450	19,450	Paket - kg
64,000	64,000	48,600	48,600	60,000	60,000	60,000	Palette - m ²
789,184	838,464	1.123,200	1.123,200	1.167,000	1.167,000	1.167,000	Palette - kg
Bla	Bla	Bla	Bla	Bla	Bla	Bla	Produktnorm
R10/B	R10/B	R10/A	R11/B	R10/A	R11/B	R12	Trittsicherheit
1 - 2	1 - 2	2 - 3	2 - 3	2 - 3	2 - 3	2 - 3	Belastung
620510-070	620460-070	601500-070-71	601550-070-71	620249-070	620450-070	620470-070	titanit
Preisgr. A150 (m ²)	Preisgr. A125 (m ²)	Preisgr. A81 (m ²)	Preisgr. A81 (m ²)	Preisgr. A61 (m ²)	Preisgr. A81 (m ²)	Preisgr. A81 (m ²)	
620510-072	620460-072	601500-072-71	601550-072-71	620249-072	620450-072	620470-072	anthrazit
Preisgr. A150 (m ²)	Preisgr. A125 (m ²)	Preisgr. A81 (m ²)	Preisgr. A81 (m ²)	Preisgr. A61 (m ²)	Preisgr. A81 (m ²)	Preisgr. A81 (m ²)	
620510-073	620460-073			620249-073	620450-073	620470-073	mittelgrau
Preisgr. A150 (m ²)	Preisgr. A125 (m ²)			Preisgr. A61 (m ²)	Preisgr. A81 (m ²)	Preisgr. A81 (m ²)	
620510-075	620460-075	601500-075-71	601550-075-71	620249-075	620450-075	620470-075	kreide
Preisgr. A150 (m ²)	Preisgr. A125 (m ²)	Preisgr. A81 (m ²)	Preisgr. A81 (m ²)	Preisgr. A61 (m ²)	Preisgr. A81 (m ²)	Preisgr. A81 (m ²)	



Wand-/Bodenfliesen

20 x 20 cm



20 x 20 cm¹



20 x 20 cm



20 x 20 cm



30 x 30 cm



30 x 30 cm



protected

Opticorn	Picstic	Geraut	Kombicorn	Micro	Softcorn 2	Nennmaß - cm/in
20 x 20 / 8 x 8	20 x 20 / 8 x 8	20 x 20 / 8 x 8	20 x 20 / 8 x 8	30 x 30 / 12 x 12	30 x 30 / 12 x 12	Herstellmaß
197 x 197 x 9,0 mm	197 x 197 x 9,0 mm	197 x 197 x 9,0 mm	197 x 197 x 9,0 mm	297 x 297 x 9,0 mm	297 x 297 x 9,0 mm	Oberfläche
genarbt, matt	genarbt, matt	profiliert, matt	profiliert, matt	strukturiert, matt	strukturiert, matt	m ² - Stück
25,000	25,000	25,000	25,000	11,111	11,111	m ² - kg
19,450	19,450	19,450	19,450	19,478	19,478	Paket - Stück
25	25	25	25	13	13	Paket - m ²
1,000	1,000	1,000	1,000	1,170	1,170	Paket - kg
19,450	19,450	19,450	19,450	22,789	22,789	Palette - m ²
60,000	60,000	60,000	60,000	56,161	56,161	Palette - kg
1.167,000	1.167,000	1.167,000	1.167,000	1.093,884	1.093,884	Produktnorm
Bla	Bla	Bla	Bla	Bla	Bla	Trittsicherheit
R12V4	R12V8	R13	R13V10	R10	R11/B	Belastung
2 - 3	2 - 3	2 - 3	2 - 3	2 - 3	2 - 3	
620290-070	620296-070			620241-070		titanit
Preisgr. A81 (m ²)	Preisgr. A125 (m ²)			Preisgr. A60 (m ²)		
620290-072	620296-072	620480-072	620490-072	620241-072	620245-072	anthrazit
Preisgr. A81 (m ²)	Preisgr. A125 (m ²)	Preisgr. A157 (m ²)	Preisgr. A157 (m ²)	Preisgr. A60 (m ²)	Preisgr. A81 (m ²)	
620290-073				620241-073		mittelgrau
Preisgr. A81 (m ²)				Preisgr. A60 (m ²)		
620290-075	620296-075	620480-075	620490-075	620241-075		kreide
Preisgr. A81 (m ²)	Preisgr. A125 (m ²)	Preisgr. A157 (m ²)	Preisgr. A157 (m ²)	Preisgr. A60 (m ²)		

¹ Auf Anfrage auch in 10,5 mm Stärke erhältlich

Wand-/
Bodenfliesen

30 x 60 cm¹



Sockel, geschnitten

7 x 20 cm



7 x 30 cm



Treppenfliesen

30 x 30 cm²



protected

Nennmaß - cm/in	Micro 30 x 60 / 12 x 24	Micro 7 x 20 / 2 13/16 x 8	Micro 7 x 30 / 2 13/16 x 12	Micro 30 x 30 / 12 x 12			
Herstellmaß	297 x 597 x 10,5 mm	70 x 197 x 9,0 mm	70 x 297 x 9,0 mm	297 x 297 x 9,0 mm			
Oberfläche	eben, matt	eben, matt	eben, matt	eben, matt			
m ² /m - Stück	5,556/m ²	5,000/m	3,333/m	3,333/m			
m ² /m - kg	23,224/m ²	1,400/m	1,399/m	5,906/m			
Paket - Stück	6	60	50	11			
Paket - m ² /m	1,080 m ²	12,000 m	15,001 m	3,300 m			
Paket - kg	25,080	16,800	21,000	19,492			
Palette - m ²	43,197						
Palette - kg	1.003,200						
Produktnorm	Bla	Bla	Bla	Bla			
Trittsicherheit	R10			R10			
Belastung	2 - 3			2 - 3			
titanit	623060-070 Preisgr. A94 (m ²)	600334-070 Preisgr. A409 (St.)	600384-070 Preisgr. A409 (St.)	600499-070 Preisgr. A441 (St.)			
anthrazit	623060-072 Preisgr. A94 (m ²)	600334-072 Preisgr. A409 (St.)	600384-072 Preisgr. A409 (St.)	600499-072 Preisgr. A441 (St.)			
mittelgrau	623060-073 Preisgr. A94 (m ²)	600334-073 Preisgr. A409 (St.)	600384-073 Preisgr. A409 (St.)	600499-073 Preisgr. A441 (St.)			
kreide	623060-075 Preisgr. A94 (m ²)	600334-075 Preisgr. A409 (St.)	600384-075 Preisgr. A409 (St.)	600499-075 Preisgr. A441 (St.)			

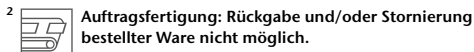

Kehlsockel

10 x 10 cm¹



10 x 15 cm¹



10 x 20 cm¹



Innenecke zu
Kehlsockel^{1/2}



Außenecke zu
Kehlsockel^{1/2}



Duschtassen-
system

10 x 10 cm³



10 x 10 cm³



protected

Nennmaß - cm/in	10 x 10 / 4 x 4	10 x 15 / 4 x 6	10 x 20 / 4 x 8			Softcorn Läufer 10 x 10 / 4 x 4	Softcorn Ecke 10 x 10 / 4 x 4
Herstellmaß	100 x 97 x 6,0 mm	102 x 147 x 9 mm	102 x 197 x 9,0 mm	102 x 20 x 9,0 mm	102 x 35 x 9,0 mm	97 x 97 x 9 mm	97 x 97 x 9 mm
Oberfläche	eben, matt	eben, matt	eben, matt	eben, matt	eben, matt	genarbt, matt	genarbt, matt
m - Stück	10,000	6,667	5,000			10,000	
m/St. - kg	1,500/m	2,000/m	2,000/m	0,080/Stück	0,080/Stück	2,020/m	0,202/Stück
Paket - Stück	40	24	20	18	12	6	4
Paket - m	4,000	3,600	4,000			0,600	
Paket - kg	6,000	7,200	8,000	1,440	0,960	1,212	0,808
Palette - m							
Palette - kg							
Produktnorm	Bla	Bla	Bla	Bla	Bla	Bla	Bla
Trittsicherheit	R10/B	R10/A	R10/A			R11/B	R11/B
titanit	600450-070 Preisgr. A409 (St.)	600430-070-71 Preisgr. A419 (St.)	600420-070 Preisgr. A419 (St.)	600416-070 Preisgr. A419 (St.)	600417-070 Preisgr. A419 (St.)	600442-070 Preisgr. A426 (St.)	600443-070 Preisgr. A456 (St.)
anthrazit	600450-072 Preisgr. A409 (St.)	600430-072-71 Preisgr. A419 (St.)	600420-072 Preisgr. A419 (St.)	600416-072 Preisgr. A419 (St.)	600417-072 Preisgr. A419 (St.)	600442-072 Preisgr. A426 (St.)	600443-072 Preisgr. A456 (St.)
mittelgrau	600450-073 Preisgr. A409 (St.)		600420-073 Preisgr. A419 (St.)	600416-073 Preisgr. A419 (St.)	600417-073 Preisgr. A419 (St.)	600442-073 Preisgr. A426 (St.)	600443-073 Preisgr. A456 (St.)
kreide	600450-075 Preisgr. A409 (St.)	600430-075-71 Preisgr. A419 (St.)	600420-075 Preisgr. A419 (St.)	600416-075 Preisgr. A419 (St.)	600417-075 Preisgr. A419 (St.)	600442-075 Preisgr. A426 (St.)	600443-075 Preisgr. A456 (St.)



¹ Details siehe S. 483

² Passend zu Kehlsockel 10 x 15 cm und 10 x 20 cm.

³ Details siehe S. 481

Wand-/Bodenplatten

25 x 12,5 cm



25 x 12,5 cm



25 x 12,5 cm



(8 mm stark)

(6 mm stark)

(8 mm stark)

				38110	18120	8110			Formatnummer
				25 x 12,5 / 10 x 5	25 x 12,5 / 10 x 5	25 x 12,5 / 10 x 5			Nennmaß - cm/in
				244 x 119 x 8 mm	244 x 119 x 6 mm	240 x 115 x 8 mm			Herstellmaß
				eben	eben	eben			Oberfläche
				32,000	32,000	33,000			m ² - Stück
				15,680	12,160	15,180			m ² - kg
				33	44	33			Paket - Stück
				1,031	1,375	1,000			Paket - m ²
				16,170	16,720	15,180			Paket - kg
				86,625	115,500	84,000			Palette - m ²
				1.358,280	1.404,480	1.275,120			Palette - kg
				Alb	Alb	Alb			Produktnorm
				700-38110	700-18120	75917-8110	3		
				Preisgr. A61 (m ²)	Preisgr. A61 (m ²)	Preisgr. A40 (m ²)			weiß glänzend
				701-38110	701-18120	75918-8110	4		
				Preisgr. A61 (m ²)	Preisgr. A61 (m ²)	Preisgr. A40 (m ²)			weiß matt
					509-18120		4		
					Preisgr. A61 (m ²)				grau
					711-18120		4		transparent matt
					Preisgr. A61 (m ²)				lichtgrau matt
				703-38110	703-18120		4		
				Preisgr. A61 (m ²)	Preisgr. A61 (m ²)				lichtsahara matt
					732-18120		3		
					Preisgr. A184 (m ²)				softazur glänzend
						71152-8110	3		
						Preisgr. A67 (m ²)			lichtblau glänzend
					563-18120		1		
					Preisgr. A184 (m ²)				azurdunkel glänzend





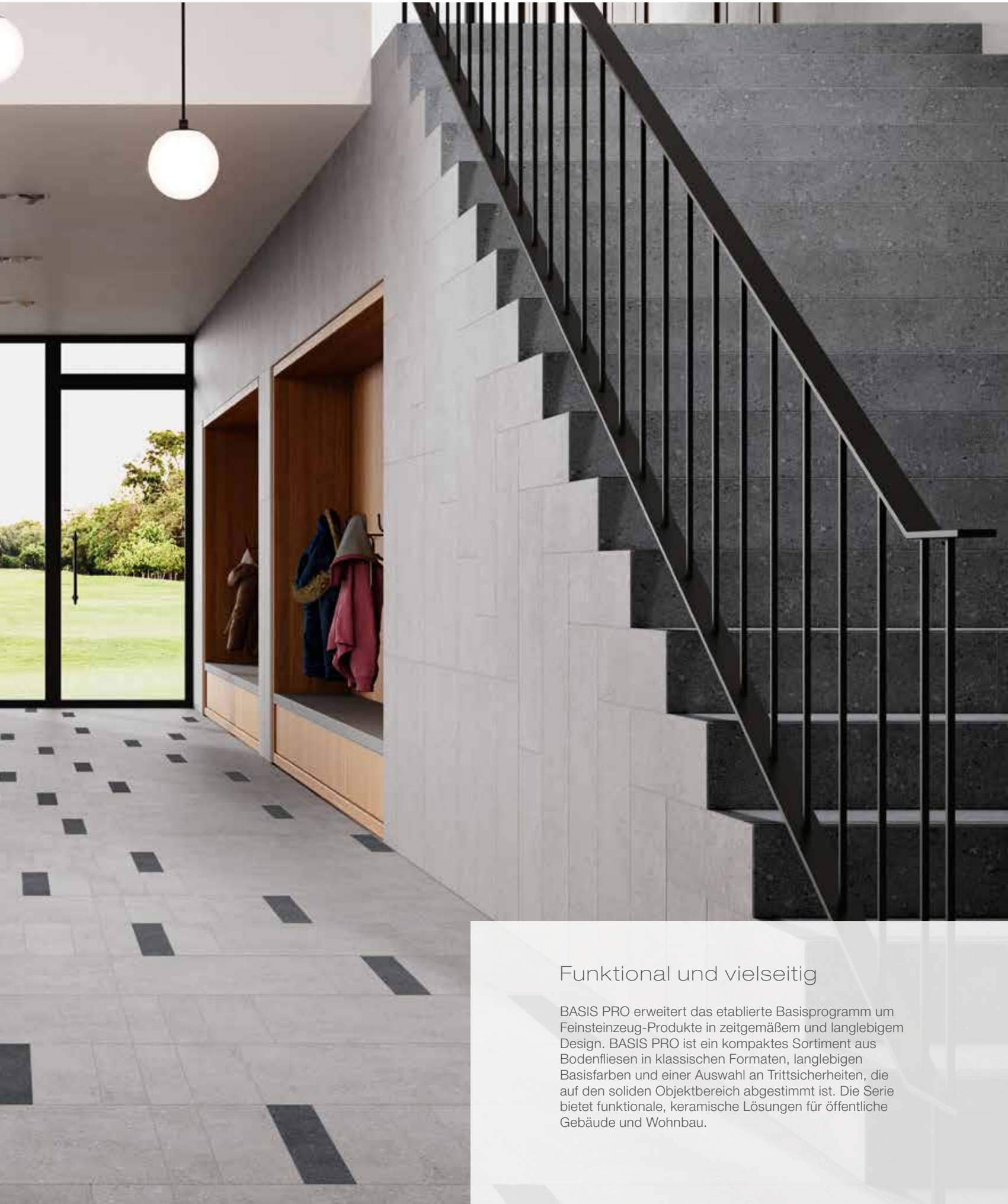

Funktional und vielseitig

BASIS PRO erweitert das etablierte Basisprogramm um Feinsteinzeug-Produkte in zeitgemäßem und langlebigem Design. BASIS PRO ist ein kompaktes Sortiment aus Bodenfliesen in klassischen Formaten, langlebigen Basisfarben und einer Auswahl an Trittsicherheiten, die auf den soliden Objektbereich abgestimmt ist. Die Serie bietet funktionale, keramische Lösungen für öffentliche Gebäude und Wohnbau.



sandbeige



aschbraun



betongrau



basalt

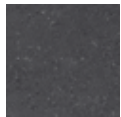

anthrazit

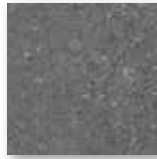

Bodenfliese 15 x 15 cm
eben, trittsicher, R10/B

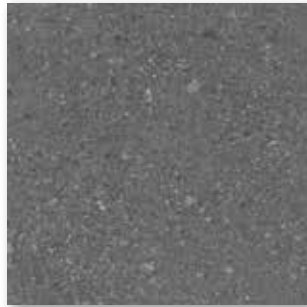

Bodenfliese 30 x 30 cm
eben, trittsicher, R10/A



Bodenfliese 10 x 60 cm
eben, trittsicher, R10/A

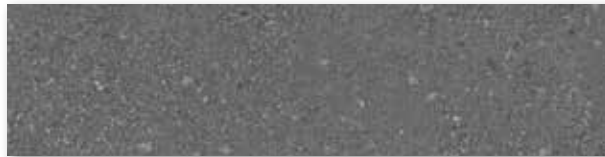

Bodenfliese 15 x 60 cm
eben, trittsicher, R10/A

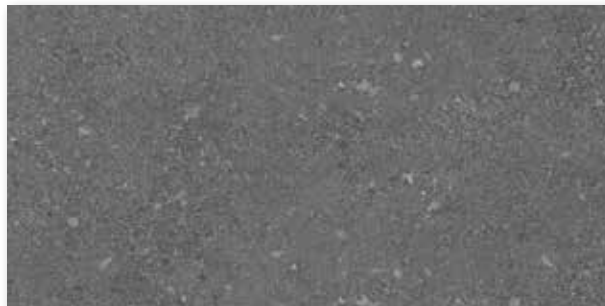

Bodenfliese 30 x 60 cm
eben, trittsicher, R10/A
eben, trittsicher, R11/B
eben, trittsicher, R12/C

Mosaik 5 x 5 cm

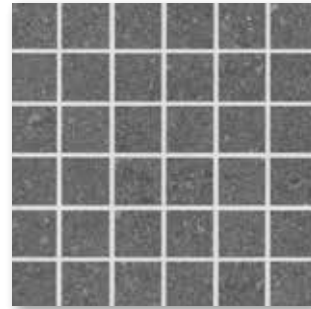

Mosaikbogen 5 x 5 cm
eben, trittsicher, R10/B

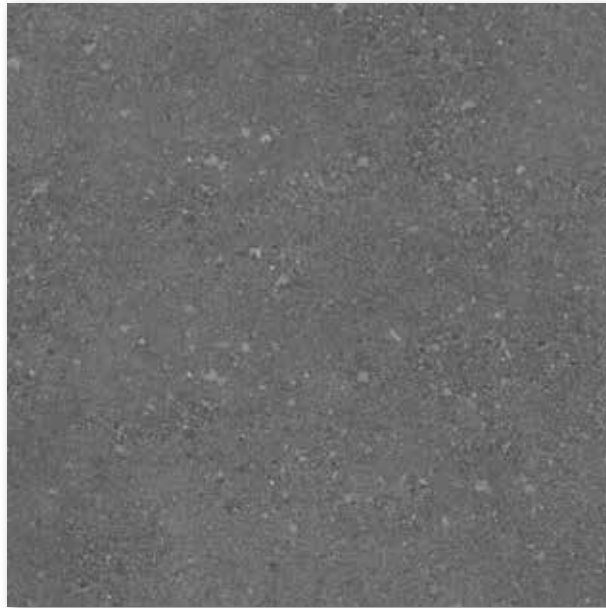

*Bodenfliese 60 x 60 cm
eben, trittsicher, R10/A*

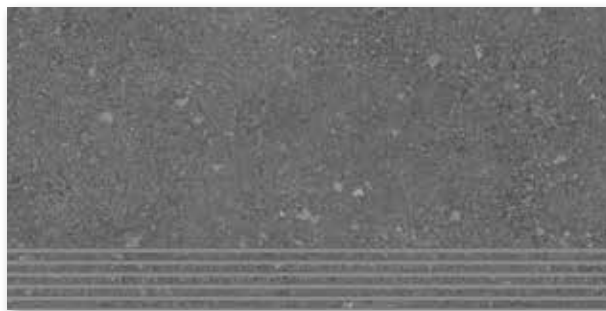

*Treppenfliese 30 x 60 cm (rilliert)
eben, trittsicher, R10/A*



*Sockel, gerundet 7 x 60 cm
eben*



*Kehlsockel dekoriert 10 x 30 cm
eben, trittsicher, R10/A*

Mosaik⁴

Bodenfliesen⁴

5 x 5 cm¹



15 x 15 cm



30 x 30 cm



10 x 60 cm^{2/3}



15 x 60 cm^{2/3}



Mosaik, rückseitig
thermoplastisch verklebt,
Bogen 297 x 297 mm

Riegelformat

Riegelformat

Nennmaß - cm/in	5 x 5 / 2 x 2	15 x 15 / 6 x 6	30 x 30 / 12 x 12	10 x 60 / 4 x 24	15 x 60 / 6 x 24		
Herstellmaß	47 x 47 x 6,5 mm	147 x 147 x 9 mm	297 x 297 x 9 mm	97 x 597 x 9 mm	147 x 597 x 9 mm		
Oberfläche	eben, matt	eben, matt	eben, matt	eben, matt	eben, matt		
m ² - Stück	11 Bögen	44,444	11,111	16,667	11,111		
m ² - kg	12,331	19,822	19,478	20,283	19,900		
Paket - Stück	11 Bögen	32	13	17	13		
Paket - m ²	1,000	0,720	1,170	1,020	1,170		
Paket - kg	12,331	14,272	22,789	20,284	23,283		
Palette - m ²	64,000	57,601	56,161	40,799	46,800		
Palette - kg	789,184	1.141,760	1.093,880	827,560	931,311		
Produktnorm	Bla	Bla	Bla	Bla	Bla		
Trittsicherheit	R10/B	R10/B	R10/A	R10/A	R10/A		
Belastung	1 - 2	2	2	2	2		
sandbeige	430901 Preisgr. A150 (m ²)	430906 Preisgr. A94 (m ²)	430911 Preisgr. A61 (m ²)	430916 Preisgr. A162 (m ²)	430921 Preisgr. A162 (m ²)		
aschbraun	430902 Preisgr. A150 (m ²)	430907 Preisgr. A94 (m ²)	430912 Preisgr. A61 (m ²)	430917 Preisgr. A162 (m ²)	430922 Preisgr. A162 (m ²)		
betongrau	430903 Preisgr. A150 (m ²)	430908 Preisgr. A94 (m ²)	430913 Preisgr. A61 (m ²)	430918 Preisgr. A162 (m ²)	430923 Preisgr. A162 (m ²)		
basalt	430904 Preisgr. A150 (m ²)	430909 Preisgr. A94 (m ²)	430914 Preisgr. A61 (m ²)	430919 Preisgr. A162 (m ²)	430924 Preisgr. A162 (m ²)		
anthrazit	430905 Preisgr. A150 (m ²)	430910 Preisgr. A94 (m ²)	430915 Preisgr. A61 (m ²)	430920 Preisgr. A162 (m ²)	430925 Preisgr. A162 (m ²)		



2 rektifiziert



³ Auftragsfertigung: Rückgabe und/oder Stornierung bestellter Ware nicht möglich.

⁴ Color Shade Variation: V2

Bodenfliesen⁴

Kehlsockel,
dekoriert

Treppenfliesen

Sockel,
gerundet

30 x 60 cm¹

30 x 60 cm¹

30 x 60 cm¹

60 x 60 cm¹

10 x 30 cm³

30 x 60 cm^{1/2}

7 x 60 cm¹

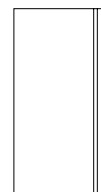
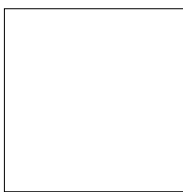
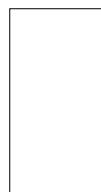

protected

30 x 60 / 12 x 24	30 x 60 / 12 x 24	30 x 60 / 12 x 24	60 x 60 / 24 x 24	10 x 30 / 4 x 12	30 x 60 / 12 x 24	7 x 60 / 2 13/16 x 24	Nennmaß - cm/in
297 x 597 x 9 mm	297 x 597 x 9 mm	297 x 597 x 9 mm	597 x 597 x 9 mm	102 x 297 x 9 mm	297 x 597 x 9 mm	70 x 597 x 9 mm	Herstellmaß
eben, matt	eben, matt	eben, matt	eben, matt	eben, matt	eben, matt	eben, matt	Oberfläche
5,556/m ²	5,556/m ²	5,556/m ²	2,778/m ²	3,333/m	1,667/m	1,667/m	m ² /m - Stück
19,907/m ²	19,907/m ²	19,907/m ²	20,371/m ²	1,999/m	5,973/m	1,357/m	m ² /m - kg
7	7	7	3	16	7	15	Paket - Stück
1,260 m ²	1,260 m ²	1,260 m ²	1,080 m ²	4,800	4,199 m	8,998 m	Paket - m ² /m
25,081	25,081	25,081	21,999	9,600	25,081	12,210	Paket - kg
50,396	50,396	50,396	45,356				Palette - m ²
1.003,240	1.003,240	1.003,240	923,950				Palette - kg
Bla	Bla	Bla	Bla	Bla	Bla	Bla	Produktnorm
R10/A	R11/B	R12/C	R10/A	R10/A	R10/A		Trittsicherheit
2	2	2	2		2		Belastung
430926	430931	430936	430941	430946	<i>430951</i>	430956	sandbeige
Preisgr. A81 (m ²)	Preisgr. A81 (m ²)	Preisgr. A119 (m ²)	Preisgr. A94 (m ²)	Preisgr. A425 (St.)	<i>Preisgr. A449 (St.)</i>	Preisgr. A438 (St.)	
430927	430932	430937	430942	430947	<i>430952</i>	430957	aschbraun
Preisgr. A81 (m ²)	Preisgr. A81 (m ²)	Preisgr. A119 (m ²)	Preisgr. A94 (m ²)	Preisgr. A425 (St.)	<i>Preisgr. A449 (St.)</i>	Preisgr. A438 (St.)	
430928	430933	430938	430943	430948	<i>430953</i>	430958	betongrau
Preisgr. A81 (m ²)	Preisgr. A81 (m ²)	Preisgr. A119 (m ²)	Preisgr. A94 (m ²)	Preisgr. A425 (St.)	<i>Preisgr. A449 (St.)</i>	Preisgr. A438 (St.)	
430929	430934	430939	430944	430949	<i>430954</i>	430959	basalt
Preisgr. A81 (m ²)	Preisgr. A81 (m ²)	Preisgr. A119 (m ²)	Preisgr. A94 (m ²)	Preisgr. A425 (St.)	<i>Preisgr. A449 (St.)</i>	Preisgr. A438 (St.)	
430930	430935	430940	430945	430950	<i>430955</i>	430960	anthrazit
Preisgr. A81 (m ²)	Preisgr. A81 (m ²)	Preisgr. A119 (m ²)	Preisgr. A94 (m ²)	Preisgr. A425 (St.)	<i>Preisgr. A449 (St.)</i>	Preisgr. A438 (St.)	

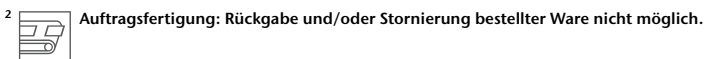

³ Details siehe S. 483

⁴ Color Shade Variation: V2



Projekt: Maximiliancenter am Hauptbahnhof / Standort: Bonn, Deutschland / Architekt: Forum Architekten & Planners BV /
Serien: Trias, Blindenleitsystem / Foto: Jochen Stüber

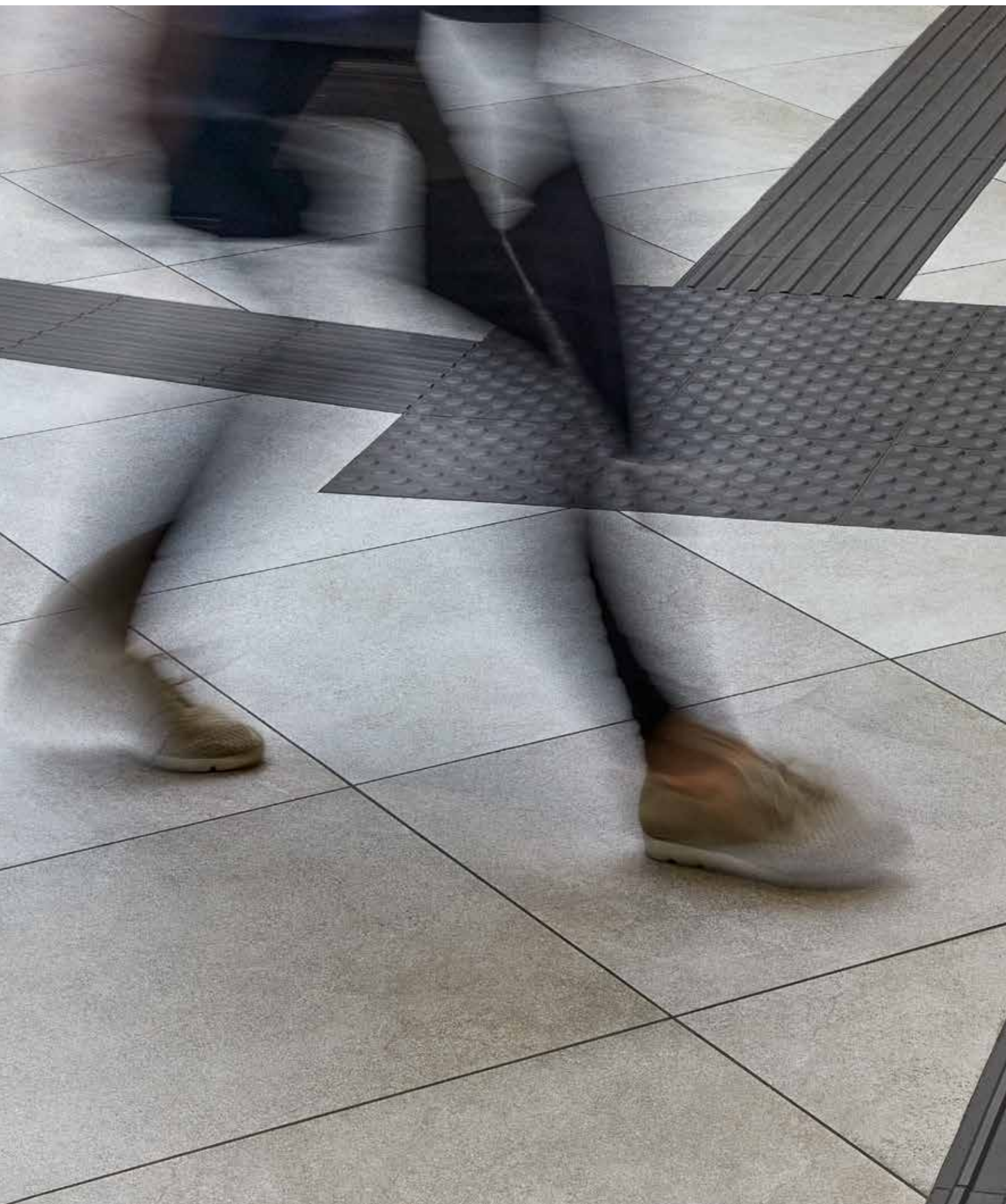





Blindenleitfliese 30 x 30 cm, Rippenstruktur

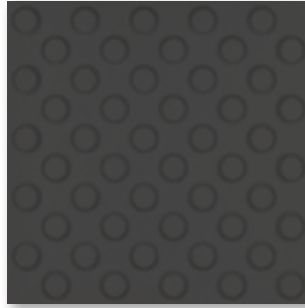

Blindenleitfliese 30 x 30 cm, Noppenstruktur



Material ConneXion, New York, Bangkok, Mailand, zeichnete das Blindleitsystem als hervorragende Leistung auf dem Gebiet der Produktentwicklung aus.

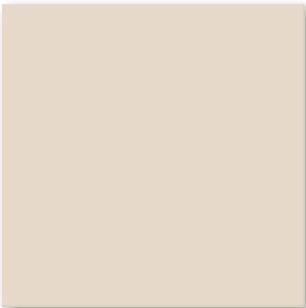

Blindenleitfliese 30 x 30 cm, trittsicher

Noppenstruktur

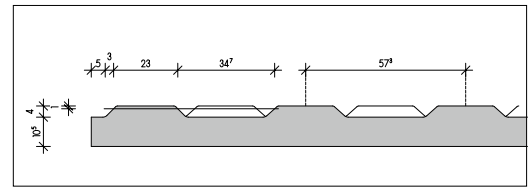
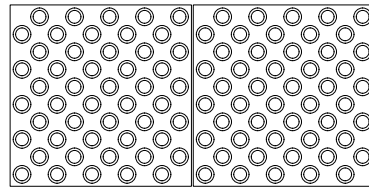

M.: 2:1

Rippenstruktur

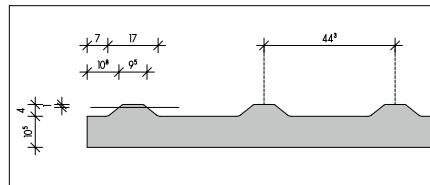
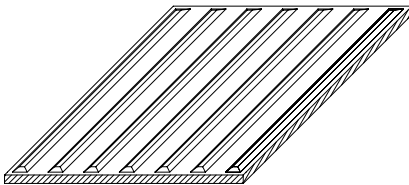

M.: 2:1

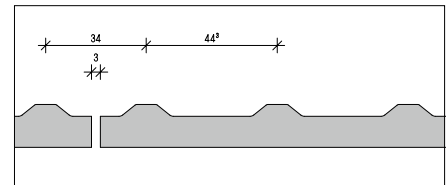

M.: 2:1

Das System entspricht den Anforderungen per DIN 32984.

Der Leuchtdichtekontrast zwischen Farbe kreide und graphit beträgt 0,7 und übertrifft die Anforderungen somit deutlich.

Gefräste Blindenleitplatte aus beliebigen Bodenfliesen auf Anfrage.

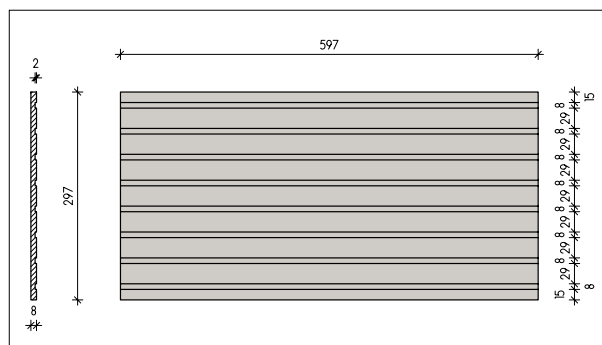

Blindenleitfliesen

Bodenfliese

30 x 30 cm

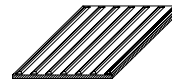

30 x 30 cm



30 x 30 cm



				30 x 30 / 12 x 12	30 x 30 / 12 x 12	30 x 30 / 12 x 12	Nennmaß - cm/in
				297 x 297 x 10,5 mm	297 x 297 x 10,5 mm	297 x 297 x 10,5 mm	Herstellmaß
				Rippenstruktur	Noppenstruktur	eben, matt	Oberfläche
				3,333/m	3,333/m	11,111/m ²	m/m ² - Stück
				7,999/m	7,999/m	23,144/m ²	m/m ² - kg
				8	8	11	Paket - Stück
				2,400 m	2,400 m	0,990 m ²	Paket - m/m ²
				19,200	19,200	22,913	Paket - kg
						47,520	Palette - m ²
						2.099,824	Palette - kg
				Bla	Bla	Bla	Produktnorm
				R11	R11	R11	Trittsicherheit
				3	3	3	Belastung
				600356-103-70	600355-103-70	600357-103-70	
				Preisgr. A455 (St.)	Preisgr. A539 (St.)	Preisgr. A162 (m ²)	kreide
				600356-106-70	600355-106-70	600357-106-70	
				Preisgr. A455 (St.)	Preisgr. A539 (St.)	Preisgr. A162 (m ²)	graphit



Analog den Anforderungen aus DIN 32984.

Weitere Blindenleitfliesen finden Sie in unserem Sortiment Area Pro





Bodenplatte 15,4 x 15,4 cm,
Rippenstruktur, kreide

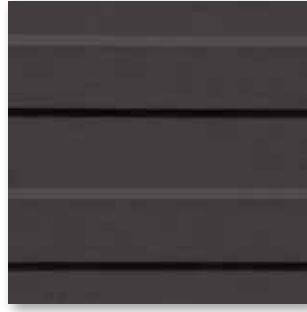

Bodenplatte 15,4 x 15,4 cm,
Rippenstruktur, anthrazit

Blindenleitplatte: 6635

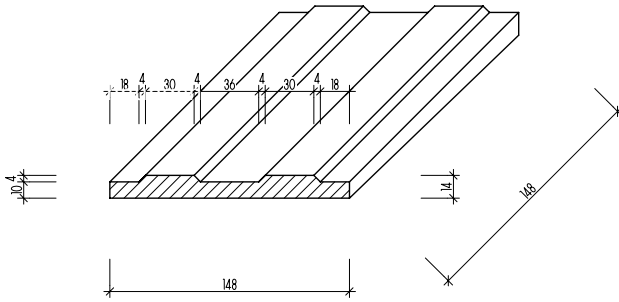

Blindenleitplatte: 6636

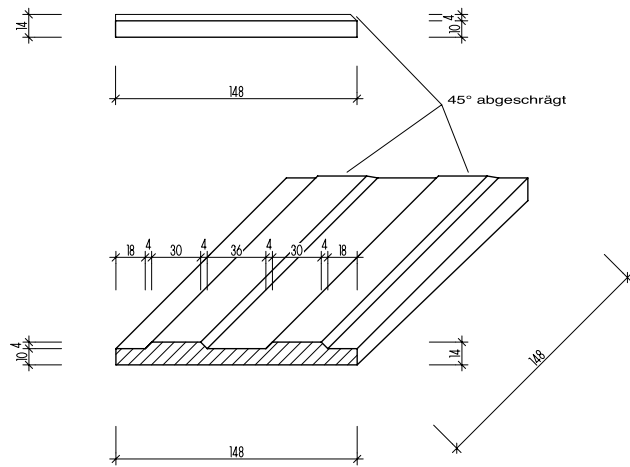

Blindenleitplatten

15,4 x 15,4 cm



15,4 x 15,4 cm



Rippenstruktur

einseitig abgeschragt,
Rippenstruktur

				6635	6636	Formatnummer
				15,4x15,4 / 63/16x63/16	15,4x15,4 / 63/16x63/16	Nennmaß - cm/in
				148 x 148 x 10 mm	148 x 148 x 10 mm	Herstellmaß
				Rippenstruktur	Rippenstruktur	Oberfläche
				6,494	6,494	m - Stück
				3,318	3,318	m - kg
				20	20	Paket - Stück
				3,080	3,080	Paket - m
				10,220	10,220	Paket - kg
						Palette - m
						Palette - kg
				Alb	Alb	Produktnorm
				R11	R11	Trittsicherheit
				3	3	Belastung
				103197-6635	103197-6636	
				Preisgr. A428 (St.)	Preisgr. A442 (St.)	kreide
				101630-6635	101630-6636	
				Preisgr. A428 (St.)	Preisgr. A442 (St.)	anthrazit



Analog den Anforderungen aus
DIN 32984.



Auftragsfertigung: Rückgabe und/oder
Stornierung bestellter Ware nicht möglich.



Projekt: Oasia Hotel / Standort: Singapur / Architekt: WOHA Architects + Patricia Urquiola / Serie: Chroma non-slip, Chroma / Foto: Infitude



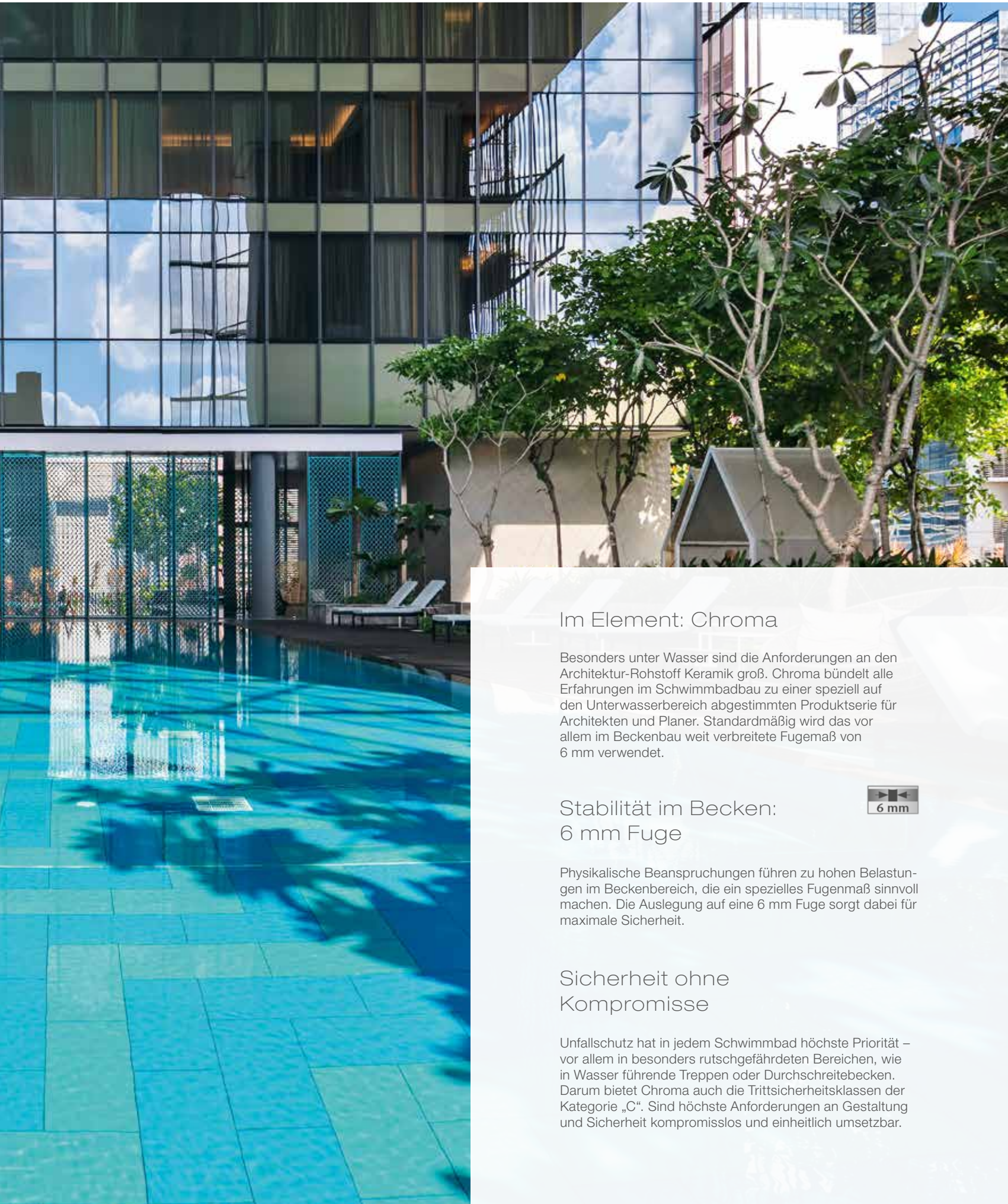

Im Element: Chroma

Besonders unter Wasser sind die Anforderungen an den Architektur-Rohstoff Keramik groß. Chroma bündelt alle Erfahrungen im Schwimmbadbau zu einer speziell auf den Unterwasserbereich abgestimmten Produktserie für Architekten und Planer. Standardmäßig wird das vor allem im Beckenbau weit verbreitete Fugemaß von 6 mm verwendet.

Stabilität im Becken: 6 mm Fuge



Physikalische Beanspruchungen führen zu hohen Belastungen im Beckenbereich, die ein spezielles Fugenmaß sinnvoll machen. Die Auslegung auf eine 6 mm Fuge sorgt dabei für maximale Sicherheit.

Sicherheit ohne Kompromisse

Unfallschutz hat in jedem Schwimmbad höchste Priorität – vor allem in besonders rutschgefährdeten Bereichen, wie in Wasser führende Treppen oder Durchschreibecken. Darum bietet Chroma auch die Trittsicherheitsklassen der Kategorie „C“. Sind höchste Anforderungen an Gestaltung und Sicherheit kompromisslos und einheitlich umsetzbar.

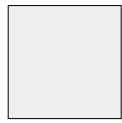

neutral 10 (aktivweiß)



azur dunkel



azur mittel



azur hell



azur aktiv

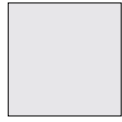

neutral 9 (weißgrau)



blau dunkel



blau mittel



blau hell



blau aktiv



neutral 8 (lichtgrau)



türkis dunkel



türkis mittel



türkis hell



türkis aktiv



neutral 7 (kieselgrau)



grün dunkel



grün mittel



grün hell



grün aktiv



neutral 6 (perlgrau)



gelb dunkel



gelb mittel



gelb hell



gelb aktiv



neutral 5 (basaltgrau)



ocker dunkel



ocker mittel



ocker hell



ocker aktiv



neutral 4 (graphitschwarz)



lachs dunkel



lachs mittel



lachs hell



lachs aktiv



neutral 3 (asphaltschwarz)



oxidrot dunkel



oxidrot mittel



oxidrot hell



oxidrot aktiv



neutral 2 (anthrazit)



steingrau dunkel



steingrau mittel



steingrau hell



steingrau aktiv



neutral 1 (tiefschwarz)



sandgrau dunkel



sandgrau mittel



sandgrau hell



sandgrau aktiv

Kontrast-Farben
(glänzend)



weiß



schwarz



orange



zitronengelb



kontrastrot



intensivblau



apfelgrün



violett



*Boden-/Wandfliese
6,2 x 25 cm*

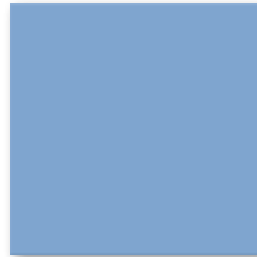

*Boden-/Wandfliese
25 x 25 cm*



*Boden-/Wandfliese
12,5 x 12,5 cm*

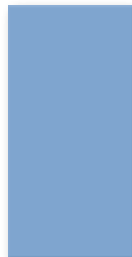

*Boden-/Wandfliese
12,5 x 25 cm*

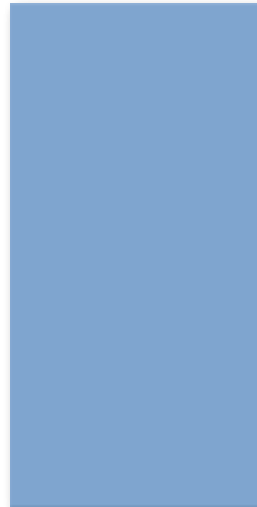

*Boden-/Wandfliese
25 x 50 cm*

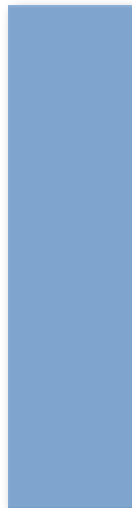

*Boden-/Wandfliese
12,5 x 50 cm*

Boden-/Wandfliesen

6,2 x 25 cm²



12,5 x 12,5 cm²



12,5 x 25 cm²



12,5 x 50 cm¹

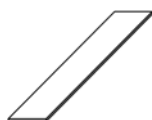

25 x 25 cm²



25 x 50 cm¹



Lieferung als Doppel-
fliesen; müssen örtlich
gebrochen werden

Lieferung als Doppel-
fliesen; müssen örtlich
gebrochen werden

Formatnummer	18210H	12020H	18120H	41550HK	12050H	42550HK
Nennmaß - cm/in	6,2 x 25 / 2 1/2 x 10	12,5 x 12,5 / 5 x 5	12,5 x 25 / 5 x 10	12,5 x 50 / 5 x 20	25 x 25 / 10 x 10	25 x 50 / 10 x 20
Herstellmaß	56 x 244 x 6 mm	119 x 119 x 6 mm	119 x 244 x 6 mm	119 x 494 x 8 mm	244 x 244 x 6 mm	244 x 494 x 8 mm
Oberfläche	eben, seidenmatt ⁵	eben, seidenmatt ⁵	eben, seidenmatt ⁵	eben, seidenmatt ⁵	eben, seidenmatt ⁵	eben, seidenmatt ⁵
m ² - Stück	64,000	64,000	32,000	16,000	16,000	8,000
m ² - kg	10,880	12,160	12,160	17,040	12,800	17,040
Paket - Stück	88	88	44	8	18	9
Paket - m ²	1,375	1,375	1,375	0,500	1,125	1,125
Paket - kg	14,960	16,720	16,720	8,520	14,400	19,170
Palette - m ²	132,000	115,500	115,500	55,000	91,125	40,500
Palette - kg	1.436,160	1.404,480	1.404,480	937,200	1.166,400	690,120
Produktnorm	Alb	Alb	Alb	Alb	Alb	Alb
Beanspruchungsgruppe	4	4	4	4	4	4
neutral 10 (aktivweiß glzd.)	700i-18210H Preisgr. A150 (m ²)	700i-12020H Preisgr. A150 (m ²)	700i-18120H Preisgr. A94 (m ²)	700i-41550HK Preisgr. A150 (m ²)	700i-12050H Preisgr. A150 (m ²)	700i-42550HK Preisgr. A150 (m ²)
neutral 10 (aktivweiß matt)	701i-18210H Preisgr. A150 (m ²)	701i-12020H Preisgr. A150 (m ²)	701i-18120H Preisgr. A94 (m ²)	701i-41550HK Preisgr. A150 (m ²)	701i-12050H Preisgr. A150 (m ²)	701i-42550HK Preisgr. A150 (m ²)
neutral 9 (weißgrau)	552119-18210H³ Preisgr. A209 (m ²)	552119-12020H³ Preisgr. A209 (m ²)	552119-18120H Preisgr. A125 (m ²)	552119-41550HK³ Preisgr. A209 (m ²)	552119-12050H³ Preisgr. A209 (m ²)	552119-42550HK³ Preisgr. A209 (m ²)
neutral 8 (lichtgrau)	552118-18210H Preisgr. A209 (m ²)	552118-12020H³ Preisgr. A209 (m ²)	552118-18120H Preisgr. A125 (m ²)	552118-41550HK³ Preisgr. A209 (m ²)	552118-12050H³ Preisgr. A209 (m ²)	552118-42550HK³ Preisgr. A209 (m ²)
neutral 7 (kieselgrau)	552117-18210H Preisgr. A177 (m ²)	552117-12020H³ Preisgr. A209 (m ²)	552117-18120H Preisgr. A125 (m ²)	552117-41550HK³ Preisgr. A209 (m ²)	552117-12050H Preisgr. A177 (m ²)	552117-42550HK³ Preisgr. A209 (m ²)
neutral 6 (perlgrau)	552116-18210H³ Preisgr. A209 (m ²)	552116-12020H³ Preisgr. A209 (m ²)	552116-18120H Preisgr. A125 (m ²)	552116-41550HK³ Preisgr. A209 (m ²)	552116-12050H³ Preisgr. A209 (m ²)	552116-42550HK³ Preisgr. A209 (m ²)
neutral 5 (basaltgrau)	552115-18210H³ Preisgr. A209 (m ²)	552115-12020H³ Preisgr. A209 (m ²)	552115-18120H³ Preisgr. A150 (m ²)	552115-41550HK³ Preisgr. A209 (m ²)	552115-12050H³ Preisgr. A209 (m ²)	552115-42550HK³ Preisgr. A209 (m ²)
neutral 4 (graphitschwarz)	552114-18210H^{3/4} Preisgr. A209 (m ²)	552114-12020H^{3/4} Preisgr. A209 (m ²)	552114-18120H^{3/4} Preisgr. A150 (m ²)	552114-41550HK^{3/4} Preisgr. A209 (m ²)	552114-12050H^{3/4} Preisgr. A209 (m ²)	552114-42550HK⁴ Preisgr. A177 (m ²)
neutral 3 (asphaltschwarz)	552113-18210H³ Preisgr. A209 (m ²)	552113-12020H³ Preisgr. A209 (m ²)	552113-18120H Preisgr. A125 (m ²)	552113-41550HK³ Preisgr. A209 (m ²)	552113-12050H³ Preisgr. A209 (m ²)	552113-42550HK³ Preisgr. A209 (m ²)
neutral 2 (anthrazit)	552112-18210H Preisgr. A177 (m ²)	552112-12020H³ Preisgr. A209 (m ²)	552112-18120H Preisgr. A125 (m ²)	552112-41550HK³ Preisgr. A209 (m ²)	552112-12050H Preisgr. A177 (m ²)	552112-42550HK Preisgr. A177 (m ²)
neutral 1 (tiefschwarz)	5716i-18210H⁴ Preisgr. A177 (m ²)	5716i-12020H⁴ Preisgr. A177 (m ²)	5716i-18120H⁴ Preisgr. A125 (m ²)	5716-41550HK⁴ Preisgr. A177 (m ²)	5716i-12050H⁴ Preisgr. A177 (m ²)	5716i-42550HK⁴ Preisgr. A177 (m ²)
azur aktiv	552001-18210H Preisgr. A177 (m ²)	552001-12020H Preisgr. A177 (m ²)	552001-18120H Preisgr. A125 (m ²)	552001-41550HK Preisgr. A177 (m ²)	552001-12050H Preisgr. A177 (m ²)	552001-42550HK Preisgr. A177 (m ²)
azur hell	552002-18210H Preisgr. A177 (m ²)	552002-12020H Preisgr. A177 (m ²)	552002-18120H Preisgr. A125 (m ²)	552002-41550HK Preisgr. A177 (m ²)	552002-12050H Preisgr. A177 (m ²)	552002-42550HK Preisgr. A177 (m ²)
azur mittel	552003-18210H Preisgr. A177 (m ²)	552003-12020H Preisgr. A177 (m ²)	552003-18120H Preisgr. A125 (m ²)	552003-41550HK³ Preisgr. A209 (m ²)	552003-12050H Preisgr. A177 (m ²)	552003-42550HK Preisgr. A177 (m ²)
azur dunkel	552004-18210H Preisgr. A177 (m ²)	552004-12020H Preisgr. A177 (m ²)	552004-18120H Preisgr. A125 (m ²)	552004-41550HK³ Preisgr. A209 (m ²)	552004-12050H³ Preisgr. A209 (m ²)	552004-42550HK³ Preisgr. A209 (m ²)
blau aktiv	552005-18210H³ Preisgr. A209 (m ²)	552005-12020H Preisgr. A177 (m ²)	552005-18120H Preisgr. A125 (m ²)	552005-41550HK³ Preisgr. A209 (m ²)	552005-12050H Preisgr. A177 (m ²)	552005-42550HK³ Preisgr. A209 (m ²)
blau hell	552006-18210H³ Preisgr. A209 (m ²)	552006-12020H Preisgr. A177 (m ²)	552006-18120H Preisgr. A125 (m ²)	552006-41550HK³ Preisgr. A209 (m ²)	552006-12050H Preisgr. A177 (m ²)	552006-42550HK Preisgr. A177 (m ²)
blau mittel	552007-18210H Preisgr. A177 (m ²)	552007-12020H Preisgr. A177 (m ²)	552007-18120H Preisgr. A125 (m ²)	552007-41550HK³ Preisgr. A209 (m ²)	552007-12050H Preisgr. A177 (m ²)	552007-42550HK Preisgr. A177 (m ²)
blau dunkel	552008-18210H Preisgr. A177 (m ²)	552008-12020H³ Preisgr. A209 (m ²)	552008-18120H Preisgr. A125 (m ²)	552008-41550HK³ Preisgr. A209 (m ²)	552008-12050H³ Preisgr. A209 (m ²)	552008-42550HK³ Preisgr. A209 (m ²)
türkis aktiv	552009-18210H Preisgr. A177 (m ²)	552009-12020H³ Preisgr. A209 (m ²)	552009-18120H Preisgr. A125 (m ²)	552009-41550HK³ Preisgr. A209 (m ²)	552009-12050H³ Preisgr. A209 (m ²)	552009-42550HK³ Preisgr. A209 (m ²)
türkis hell	552010-18210H Preisgr. A177 (m ²)	552010-12020H Preisgr. A177 (m ²)	552010-18120H Preisgr. A125 (m ²)	552010-41550HK³ Preisgr. A209 (m ²)	552010-12050H³ Preisgr. A209 (m ²)	552010-42550HK³ Preisgr. A209 (m ²)
türkis mittel	552011-18210H Preisgr. A177 (m ²)	552011-12020H Preisgr. A177 (m ²)	552011-18120H Preisgr. A125 (m ²)	552011-41550HK³ Preisgr. A209 (m ²)	552011-12050H Preisgr. A177 (m ²)	552011-42550HK³ Preisgr. A209 (m ²)
türkis dunkel	552012-18210H⁴ Preisgr. A177 (m ²)	552012-12020H⁴ Preisgr. A177 (m ²)	552012-18120H⁴ Preisgr. A125 (m ²)	552012-41550HK^{3/4} Preisgr. A209 (m ²)	552012-12050H^{3/4} Preisgr. A209 (m ²)	552012-42550HK^{3/4} Preisgr. A209 (m ²)



¹ rektifiziert

² Überglasierte Kanten / Ecken siehe S. 105

³ Auftragsfertigung: Rückgabe und/oder Stornierung bestellter Ware nicht möglich.

⁴ produktionsbedingte Farbabweichungen zum Standard sind möglich.

⁵ Ausnahme neutral 10 (aktivweiß glzd.): eben, glänzend

Überglasierte Kanten/Ecken^{1/2} Boden-/Wandfliesen

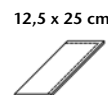

<i>überglasierte Ecke links</i>	<i>überglasierte Ecke rechts</i>	<i>überglasierte Ecke links</i>	<i>überglasierte Ecke links</i>	<i>überglasierte Ecke rechts</i>	<i>überglasierte Ecke links</i>	Beanspruchungsgruppe	Formatnummer Nennmaß - cm/in Herstellmaß Oberfläche m ² - Stück m ² - kg Paket - Stück Paket - m ² Paket - kg Palette - m ² Palette - kg Produktnorm
18213H 6,2 x 25 / 2 1/2 x 10 56 x 244 x 6 mm eben, seidenmatt ⁴ 64,000 10,880 88 1,375 14,960 132,000 1.436,160 Alb	18214H 6,2 x 25 / 2 1/2 x 10 56 x 244 x 6 mm eben, seidenmatt ⁴ 64,000 10,880 88 1,375 14,960 132,000 1.436,160 Alb	12023H 12,5 x 12,5 / 5 x 5 119 x 119 x 6 mm eben, seidenmatt ⁴ 64,000 12,160 88 1,375 16,720 115,500 1.404,480 Alb	18123H 12,5 x 25 / 5 x 10 119 x 244 x 6 mm eben, seidenmatt ⁴ 32,000 12,160 44 1,375 16,720 115,500 1.404,480 Alb	18124H 12,5 x 25 / 5 x 10 119 x 244 x 6 mm eben, seidenmatt ⁴ 32,000 12,160 44 1,375 16,720 115,500 1.404,480 Alb	12053H 25 x 25 / 10 x 10 244 x 244 x 6 mm eben, seidenmatt ⁴ 16,000 12,800 18 1,125 14,400 91,125 1.166,400 Alb		
700i-18213H Preisgr. A150 (m ²) 701i-18213H Preisgr. A150 (m ²)	700i-18214H Preisgr. A150 (m ²) 701i-18214H Preisgr. A150 (m ²)	700i-12023H Preisgr. A150 (m ²) 701i-12023H Preisgr. A150 (m ²)	700i-18123H Preisgr. A94 (m ²) 701i-18123H Preisgr. A94 (m ²)	700i-18124H Preisgr. A94 (m ²) 701i-18124H Preisgr. A94 (m ²)	700i-12053H Preisgr. A150 (m ²) 701i-12053H Preisgr. A150 (m ²)	4	neutral 10 (aktivweiß matt)
5716i-18213H ³ Preisgr. A177 (m ²) 552001-18213H Preisgr. A177 (m ²) 552002-18213H Preisgr. A177 (m ²)	5716i-18214H ³ Preisgr. A177 (m ²) 552001-18214H Preisgr. A177 (St.) 552002-18214H Preisgr. A177 (m ²)	5716i-12023H ³ Preisgr. A177 (m ²) 552001-12023H Preisgr. A177 (m ²) 552002-12023H Preisgr. A177 (m ²)	5716i-18123H ³ Preisgr. A125 (m ²) 552001-18123H Preisgr. A125 (m ²) 552002-18123H Preisgr. A125 (m ²)	5716i-18124H ³ Preisgr. A125 (m ²) 552001-18124H Preisgr. A125 (m ²) 552002-18124H Preisgr. A125 (m ²)	5716i-12053H ³ Preisgr. A177 (m ²) 552001-12053H Preisgr. A177 (m ²) 552002-12053H Preisgr. A177 (m ²)	1 2 4	neutral 1 (tiefschwarz) azur aktiv azur hell

¹ weitere Farben auf Anfrage lieferbar

² Auftragsfertigung: Rückgabe und/oder Stornierung bestellter Ware nicht möglich.



³ Produktionsbedingte Farbabweichung zum Standard möglich.

⁴ Ausnahme neutral 10 (aktivweiß glzd.): eben, glänzend



Überglasierte Kanten
auf Anfrage lieferbar:



Grundformat-Nr. statt
Endziffer 0 Endziffer ...

... 3 = Ecke links

... 4 = Ecke rechts

überglasierte Kanten

Beispiel: Grundformat-Nr. 18120 = 119 x 244 x 6 mm,
Format-Nr. 18123 = überglasierte Ecke links

Boden-/Wandfliesen

6,2 x 25 cm²



12,5 x 12,5 cm²



12,5 x 25 cm²



12,5 x 50 cm¹

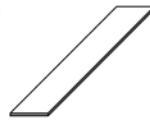

25 x 25 cm²



25 x 50 cm¹

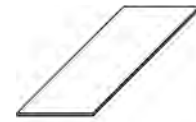

Lieferung als Doppel-
fliesen; müssen örtlich
gebrochen werden

Lieferung als Doppel-
fliesen; müssen örtlich
gebrochen werden

Formatnummer	18210H	12020H	18120H	41550HK	12050H	42550HK
Nennmaß - cm/in	6,2 x 25 / 2 1/2 x 10	12,5 x 12,5 / 5 x 5	12,5 x 25 / 5 x 10	12,5 x 50 / 5 x 20	25 x 25 / 10 x 10	25 x 50 / 10 x 20
Herstellmaß	56 x 244 x 6 mm	119 x 119 x 6 mm	119 x 244 x 6 mm	119 x 494 x 8 mm	244 x 244 x 6 mm	244 x 494 x 8 mm
Oberfläche	eben, seidenmatt	eben, seidenmatt	eben, seidenmatt	eben, seidenmatt	eben, seidenmatt	eben, seidenmatt
m ² - Stück	64,000	64,000	32,000	16,000	16,000	8,000
m ² - kg	10,880	12,160	12,160	17,040	12,800	17,040
Paket - Stück	88	88	44	8	18	9
Paket - m ²	1,375	1,375	1,375	0,500	1,125	1,125
Paket - kg	14,960	16,720	16,720	8,520	14,400	19,170
Palette - m ²	132,000	115,500	115,500	55,000	91,125	40,500
Palette - kg	1.436,160	1.404,480	1.404,480	937,200	1.166,400	690,120
Produktnorm	Alb	Alb	Alb	Alb	Alb	Alb
grün aktiv	2 552013-18210H Preisgr. A177 (m ²)	552013-12020H Preisgr. A177 (m ²)	552013-18120H Preisgr. A125 (m ²)	<i>552013-41550HK³</i> Preisgr. A209 (m ²)	<i>552013-12050H³</i> Preisgr. A209 (m ²)	<i>552013-42550HK³</i> Preisgr. A209 (m ²)
grün hell	4 552014-18210H Preisgr. A177 (m ²)	552014-12020H Preisgr. A177 (m ²)	552014-18120H Preisgr. A125 (m ²)	<i>552014-41550HK³</i> Preisgr. A209 (m ²)	552014-12050H Preisgr. A177 (m ²)	<i>552014-42550HK³</i> Preisgr. A209 (m ²)
grün mittel	3 552015-18210H Preisgr. A177 (m ²)	552015-12020H Preisgr. A177 (m ²)	552015-18120H Preisgr. A125 (m ²)	<i>552015-41550HK³</i> Preisgr. A209 (m ²)	552015-12050H Preisgr. A177 (m ²)	552015-42550HK Preisgr. A177 (m ²)
grün dunkel	2 552016-18210H Preisgr. A177 (m ²)	552016-12020H Preisgr. A177 (m ²)	552016-18120H Preisgr. A125 (m ²)	<i>552016-41550HK³</i> Preisgr. A209 (m ²)	552016-12050H Preisgr. A177 (m ²)	<i>552016-42550HK³</i> Preisgr. A209 (m ²)
gelb aktiv	2 <i>552017-18210H^{3/4}</i> Preisgr. A209 (m ²)	<i>552017-12020H^{3/4}</i> Preisgr. A209 (m ²)	552017-18120H⁴ Preisgr. A125 (m ²)	<i>552017-41550HK^{3/4}</i> Preisgr. A209 (m ²)	<i>552017-12050H^{3/4}</i> Preisgr. A209 (m ²)	<i>552017-42550HK^{3/4}</i> Preisgr. A209 (m ²)
gelb hell	4 <i>552018-18210H³</i> Preisgr. A209 (m ²)	552018-12020H Preisgr. A177 (m ²)	552018-18120H Preisgr. A125 (m ²)	<i>552018-41550HK³</i> Preisgr. A209 (m ²)	552018-12050H Preisgr. A177 (m ²)	552018-42550HK Preisgr. A177 (m ²)
gelb mittel	3 552019-18210H Preisgr. A177 (m ²)	552019-12020H Preisgr. A177 (m ²)	552019-18120H Preisgr. A125 (m ²)	<i>552019-41550HK³</i> Preisgr. A209 (m ²)	552019-12050H Preisgr. A177 (m ²)	<i>552019-42550HK³</i> Preisgr. A209 (m ²)
gelb dunkel	2 552020-18210H⁴ Preisgr. A177 (m ²)	<i>552020-12020H^{3/4}</i> Preisgr. A209 (m ²)	552020-18120H⁴ Preisgr. A125 (m ²)	<i>552020-41550HK^{3/4}</i> Preisgr. A209 (m ²)	<i>552020-12050H^{3/4}</i> Preisgr. A209 (m ²)	<i>552020-42550HK^{3/4}</i> Preisgr. A209 (m ²)
ocker aktiv	2 <i>552021-18210H^{3/4}</i> Preisgr. A209 (m ²)	<i>552021-12020H^{3/4}</i> Preisgr. A209 (m ²)	<i>552021-18120H^{3/4}</i> Preisgr. A150 (m ²)	<i>552021-41550HK^{3/4}</i> Preisgr. A209 (m ²)	<i>552021-12050H^{3/4}</i> Preisgr. A209 (m ²)	<i>552021-42550HK^{3/4}</i> Preisgr. A209 (m ²)
ocker hell	4 552022-18210H Preisgr. A177 (m ²)	<i>552022-12020H³</i> Preisgr. A209 (m ²)	<i>552022-18120H³</i> Preisgr. A150 (m ²)	<i>552022-41550HK³</i> Preisgr. A209 (m ²)	<i>552022-12050H³</i> Preisgr. A209 (m ²)	<i>552022-42550HK³</i> Preisgr. A209 (m ²)
ocker mittel	3 <i>552023-18210H³</i> Preisgr. A209 (m ²)	<i>552023-12020H³</i> Preisgr. A209 (m ²)	552023-18120H Preisgr. A125 (m ²)	<i>552023-41550HK³</i> Preisgr. A209 (m ²)	<i>552023-12050H³</i> Preisgr. A209 (m ²)	<i>552023-42550HK³</i> Preisgr. A209 (m ²)
ocker dunkel	2 <i>552024-18210H³</i> Preisgr. A209 (m ²)	<i>552024-12020H³</i> Preisgr. A209 (m ²)	552024-18120H Preisgr. A125 (m ²)	<i>552024-41550HK³</i> Preisgr. A209 (m ²)	<i>552024-12050H³</i> Preisgr. A209 (m ²)	<i>552024-42550HK³</i> Preisgr. A209 (m ²)
lachs aktiv	2 552025-18210H⁴ Preisgr. A177 (m ²)	<i>552025-12020H^{3/4}</i> Preisgr. A209 (m ²)	<i>552025-18120H^{3/4}</i> Preisgr. A150 (m ²)	<i>552025-41550HK^{3/4}</i> Preisgr. A209 (m ²)	<i>552025-12050H^{3/4}</i> Preisgr. A209 (m ²)	<i>552025-42550HK^{3/4}</i> Preisgr. A209 (m ²)
lachs hell	4 552026-18210H Preisgr. A177 (m ²)	<i>552026-12020H³</i> Preisgr. A209 (m ²)	552026-18120H Preisgr. A125 (m ²)	<i>552026-41550HK³</i> Preisgr. A209 (m ²)	<i>552026-12050H³</i> Preisgr. A209 (m ²)	<i>552026-42550HK³</i> Preisgr. A209 (m ²)
lachs mittel	3 552027-18210H Preisgr. A177 (m ²)	<i>552027-12020H³</i> Preisgr. A209 (m ²)	<i>552027-18120H³</i> Preisgr. A150 (m ²)	<i>552027-41550HK³</i> Preisgr. A209 (m ²)	552027-12050H Preisgr. A177 (m ²)	<i>552027-42550HK³</i> Preisgr. A209 (m ²)
lachs dunkel	2 <i>552028-18210H³</i> Preisgr. A209 (m ²)	<i>552028-12020H³</i> Preisgr. A209 (m ²)	<i>552028-18120H³</i> Preisgr. A150 (m ²)	<i>552028-41550HK³</i> Preisgr. A209 (m ²)	<i>552028-12050H³</i> Preisgr. A209 (m ²)	<i>552028-42550HK³</i> Preisgr. A209 (m ²)
oxidrot aktiv	2 552029-18210H Preisgr. A177 (m ²)	<i>552029-12020H³</i> Preisgr. A209 (m ²)	552029-18120H Preisgr. A125 (m ²)	<i>552029-41550HK³</i> Preisgr. A209 (m ²)	552029-12050H Preisgr. A177 (m ²)	<i>552029-42550HK³</i> Preisgr. A209 (m ²)
oxidrot hell	4 <i>552030-18210H³</i> Preisgr. A209 (m ²)	<i>552030-12020H³</i> Preisgr. A209 (m ²)	<i>552030-18120H³</i> Preisgr. A150 (m ²)	<i>552030-41550HK³</i> Preisgr. A209 (m ²)	552030-12050H Preisgr. A177 (m ²)	<i>552030-42550HK³</i> Preisgr. A209 (m ²)
oxidrot mittel	3 552031-18210H Preisgr. A177 (m ²)	<i>552031-12020H³</i> Preisgr. A209 (m ²)	<i>552031-18120H³</i> Preisgr. A150 (m ²)	<i>552031-41550HK³</i> Preisgr. A209 (m ²)	552031-12050H Preisgr. A177 (m ²)	<i>552031-42550HK³</i> Preisgr. A209 (m ²)
oxidrot dunkel	2 552032-18210H Preisgr. A177 (m ²)	<i>552032-12020H³</i> Preisgr. A209 (m ²)	552032-18120H Preisgr. A125 (m ²)	<i>552032-41550HK³</i> Preisgr. A209 (m ²)	<i>552032-12050H³</i> Preisgr. A209 (m ²)	<i>552032-42550HK³</i> Preisgr. A209 (m ²)



1 rektifiziert

2 Überglasierte Kanten / Ecken siehe S. 105

3 Auftragsfertigung: Rückgabe und/oder Stormierung bestellter Ware nicht möglich.

4 produktionsbedingte Farbabweichungen zum Standard sind möglich.

Boden-/Wandfliesen

6,2 x 25 cm²

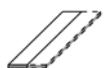

12,5 x 12,5 cm²



12,5 x 25 cm²



12,5 x 50 cm¹

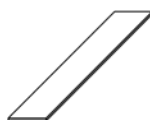

25 x 25 cm²



25 x 50 cm¹



Lieferung als Doppel-
fliesen; müssen örtlich
gebrochen werden

Lieferung als Doppel-
fliesen; müssen örtlich
gebrochen werden



18210H	12020H	18120H	41550HK	12050H	42550HK	Beanspruchungsgruppe	Formatnummer
6,2 x 25 / 2 1/2 x 10	12,5 x 12,5 / 5 x 5	12,5 x 25 / 5 x 10	12,5 x 50 / 5 x 20	25 x 25 / 10 x 10	25 x 50 / 10 x 20		
56 x 244 x 6 mm	119 x 119 x 6 mm	119 x 244 x 6 mm	119 x 494 x 8 mm	244 x 244 x 6 mm	244 x 494 x 8 mm		Herstellmaß
eben, seidenmatt ⁶	eben, seidenmatt ⁶	eben, seidenmatt ⁶	eben, seidenmatt ⁶	eben, seidenmatt ⁶	eben, seidenmatt ⁶		Oberfläche
64,000	64,000	32,000	16,000	16,000	8,000		m ² - Stück
10,880	12,160	12,160	17,040	12,800	17,040		m ² - kg
88	88	44	8	18	9		Paket - Stück
1,375	1,375	1,375	0,500	1,125	1,125		Paket - m ²
14,960	16,720	16,720	8,520	14,400	19,170		Paket - kg
132,000	115,500	115,500	55,000	91,125	40,500		Palette - m ²
1.436,160	1.404,480	1.404,480	937,200	1.166,400	690,120		Palette - kg
Alb	Alb	Alb	Alb	Alb	Alb		Produktnorm
552033-18210H	552033-12020H³	552033-18120H	552033-41550HK³	552033-12050H³	552033-42550HK³	2	steingrau aktiv
Preisgr. A177 (m ²)	Preisgr. A209 (m ²)	Preisgr. A125 (m ²)	Preisgr. A209 (m ²)	Preisgr. A209 (m ²)	Preisgr. A209 (m ²)		
552034-18210H³	552034-12020H³	552034-18120H³	552034-41550HK³	552034-12050H³	552034-42550HK³	4	steingrau hell
Preisgr. A209 (m ²)	Preisgr. A209 (m ²)	Preisgr. A150 (m ²)	Preisgr. A209 (m ²)	Preisgr. A209 (m ²)	Preisgr. A209 (m ²)		
552035-18210H	552035-12020H	552035-18120H	552035-41550HK³	552035-12050H³	552035-42550HK³	3	steingrau mittel
Preisgr. A177 (m ²)	Preisgr. A177 (m ²)	Preisgr. A125 (m ²)	Preisgr. A209 (m ²)	Preisgr. A209 (m ²)	Preisgr. A209 (m ²)		
552036-18210H³	552036-12020H³	552036-18120H	552036-41550HK³	552036-12050H³	552036-42550HK³	2	steingrau dunkel
Preisgr. A209 (m ²)	Preisgr. A209 (m ²)	Preisgr. A125 (m ²)	Preisgr. A209 (m ²)	Preisgr. A209 (m ²)	Preisgr. A209 (m ²)		
552037-18210H³	552037-12020H³	552037-18120H	552037-41550HK³	552037-12050H³	552037-42550HK³	2	sandgrau aktiv
Preisgr. A209 (m ²)	Preisgr. A209 (m ²)	Preisgr. A125 (m ²)	Preisgr. A209 (m ²)	Preisgr. A209 (m ²)	Preisgr. A209 (m ²)		
552038-18210H	552038-12020H	552038-18120H	552038-41550HK³	552038-12050H³	552038-42550HK³	4	sandgrau hell
Preisgr. A177 (m ²)	Preisgr. A177 (m ²)	Preisgr. A125 (m ²)	Preisgr. A209 (m ²)	Preisgr. A177 (m ²)	Preisgr. A209 (m ²)		
552039-18210H³	552039-12020H³	552039-18120H	552039-41550HK³	552039-12050H³	552039-42550HK³	3	sandgrau mittel
Preisgr. A209 (m ²)	Preisgr. A209 (m ²)	Preisgr. A125 (m ²)	Preisgr. A209 (m ²)	Preisgr. A209 (m ²)	Preisgr. A209 (m ²)		
552040-18210H³	552040-12020H³	552040-18120H	552040-41550HK³	552040-12050H³	552040-42550HK	2	sandgrau dunkel
Preisgr. A209 (m ²)	Preisgr. A209 (m ²)	Preisgr. A125 (m ²)	Preisgr. A209 (m ²)	Preisgr. A209 (m ²)	Preisgr. A177 (m ²)		
717i-18210H³	717i-12020H³	717i-18120H³	717i-41550HK³	717i-12050H³	717i-42550HK³	1	schwarz glänzend
Preisgr. A209 (m ²)	Preisgr. A209 (m ²)	Preisgr. A150 (m ²)	Preisgr. A209 (m ²)	Preisgr. A209 (m ²)	Preisgr. A209 (m ²)		
151i-18210H³	151i-12020H³	151i-18120H³	151i-41550HK³	151i-12050H³	151i-42550HK³	1	orange glänzend
Preisgr. A209 (m ²)	Preisgr. A209 (m ²)	Preisgr. A150 (m ²)	Preisgr. A209 (m ²)	Preisgr. A209 (m ²)	Preisgr. A209 (m ²)		
150i-18210H³	150i-12020H³	150i-18120H³	150i-41550HK³	150i-12050H³	150i-42550HK³	2	zitronengelb glänzend
Preisgr. A209 (m ²)	Preisgr. A209 (m ²)	Preisgr. A150 (m ²)	Preisgr. A209 (m ²)	Preisgr. A209 (m ²)	Preisgr. A209 (m ²)		
154i-18210H³	154i-12020H³	154i-18120H³	154i-41550HK³	154i-12050H³	154i-42550HK³	1	kontrastrot glänzend
Preisgr. A209 (m ²)	Preisgr. A209 (m ²)	Preisgr. A150 (m ²)	Preisgr. A209 (m ²)	Preisgr. A209 (m ²)	Preisgr. A209 (m ²)		
144-18210^{3/5}	144-12020^{3/5}	144-18120^{3/5}	144-41550K^{3/5}	144-12050^{3/5}	144-42550K^{3/5}	1	intensivblau glänzend
Preisgr. A209 (m ²)	Preisgr. A209 (m ²)	Preisgr. A150 (m ²)	Preisgr. A209 (m ²)	Preisgr. A209 (m ²)	Preisgr. A209 (m ²)		
152i-18210H³	152i-12020H³	152i-18120H³	152i-41550HK³	152i-12050H³	152i-42550HK³	2	apfelgrün glänzend
Preisgr. A209 (m ²)	Preisgr. A209 (m ²)	Preisgr. A150 (m ²)	Preisgr. A209 (m ²)	Preisgr. A209 (m ²)	Preisgr. A209 (m ²)		
153i-18210H³	153i-12020H³	153i-18120H³	153i-41550HK³	153i-12050H³	153i-42550HK³	1	violett glänzend
Preisgr. A209 (m ²)	Preisgr. A209 (m ²)	Preisgr. A150 (m ²)	Preisgr. A209 (m ²)	Preisgr. A209 (m ²)	Preisgr. A209 (m ²)		

rektifiziert

² Überglasierte Kanten / Ecken siehe S. 105

³ Auftragsfertigung: Rückgabe und/oder Stornierung bestellter Ware nicht möglich.

⁴ produktionsbedingte Farbabweichungen zum Standard sind möglich

⁵ ohne Hytect-Veredelung

⁶ Ausnahme: Kontrastfarben schwarz, orange, zitronengelb, kontrastrot, intensivblau, apfelgrün, violett: eben, glänzend



Überglasierte Kanten
auf Anfrage lieferbar:



Grundformat-Nr. statt
Endziffer 0 Endziffer ...

... 3 = Ecke links

... 4 = Ecke rechts

überglasierte Kanten

Beispiel: Grundformat-Nr. 18120 = 119 x 244 x 6 mm,
Format-Nr. 18123 = überglasierte Ecke links



Projekt: Solebad / Standort: Werne, Deutschland / Architekt: Geising + Böker GmbH, Büro Vechta /
Serie: Chroma non-slip, Chroma Pool / Foto: Jochen Stüber





Trittsicherheit „B“

-/B



weiß / neutral 10
(aktivweiß)

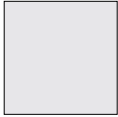

neutral 9
(weißgrau)



neutral 8
(lichtgrau)



553117 neutral 7
(kieselgrau)



neutral 6
(perlgrau)



neutral 5
(basaltgrau)



neutral 4
(graphitschwarz)



neutral 3
(asphaltschwarz)



neutral 2
(anthrazit)



schwarz / neutral 1
(tiefschwarz)

-/B



azur dunkel



blau dunkel



grün dunkel



azur mittel



blau mittel



türkis mittel



grün mittel



gelb mittel



ocker mittel



lachs mittel



oxidrot mittel



steingrau dunkel



sandgrau dunkel



steingrau mittel



sandgrau mittel



azur hell



blau hell



türkis hell



grün hell



gelb hell



lachs hell



oxidrot hell



steingrau hell



sandgrau hell

-/B



azur aktiv



steingrau aktiv



sandgrau aktiv

-/B



kontrastrot



Bodenfliese
12,5 x 12,5 cm



Bodenfliese
12,5 x 25 cm



Bodenfliese
25 x 25 cm

Auf Anfrage sind weitere Farben der Serie Chroma als non-slip Glasur in 6 mm Fugenbreite lieferbar.

Trittsicherheit „B“

Bodenfliesen

12,5 x 12,5 cm²



12,5 x 25 cm²



25 x 25 cm²



Lieferung als Doppel-
fliesen; müssen örtlich
gebrochen werden



32020H	38110H	32050H	Formatnummer
12,5 x 12,5 / 5 x 5	12,5 x 25 / 5 x 10	25 x 25 / 10 x 10	Nennmaß - cm/in
119 x 119 x 8 mm	119 x 244 x 8 mm	244 x 244 x 8 mm	Herstellmaß
eben, seidenmatt	eben, seidenmatt	eben, seidenmatt	Oberfläche
64,000	32,000	16,000	m ² - Stück
15,360	15,680	16,960	m ² - kg
66	33	14	Paket - Stück
1,031	1,031	0,875	Paket - m ²
15,840	16,170	14,840	Paket - kg
86,625	86,625	70,875	Palette - m ²
1.330,560	1.358,280	1.202,040	Palette - kg
Alb	Alb	Alb	Produktnorm
-/B	-/B	-/B	Trittsicherheit
2	2	2	Belastung
91i-32020H	91i-38110H	91i-32050H	neutral 10
Preisgr. A216 (m ²)	Preisgr. A192 (m ²)	Preisgr. A210 (m ²)	(aktivweiß)
340i-32020H	340i-38110H	340i-32050H	neutral 1
Preisgr. A216 (m ²)	Preisgr. A192 (m ²)	Preisgr. A210 (m ²)	(tiefschwarz)
553001-32020H	553001-38110H	553001-32050H	azur aktiv
Preisgr. A216 (m ²)	Preisgr. A192 (m ²)	Preisgr. A210 (m ²)	
553002-32020H	553002-38110H	553002-32050H	azur hell
Preisgr. A216 (m ²)	Preisgr. A192 (m ²)	Preisgr. A210 (m ²)	
553003-32020H	553003-38110H	553003-32050H	azur mittel
Preisgr. A216 (m ²)	Preisgr. A192 (m ²)	Preisgr. A210 (m ²)	
553004-32020H	553004-38110H	553004-32050H	azur dunkel
Preisgr. A216 (m ²)	Preisgr. A192 (m ²)	Preisgr. A210 (m ²)	
553006-32020H	553006-38110H	553006-32050H	blau hell
Preisgr. A216 (m ²)	Preisgr. A192 (m ²)	Preisgr. A210 (m ²)	
553007-32020H	553007-38110H	553007-32050H	blau mittel
Preisgr. A216 (m ²)	Preisgr. A192 (m ²)	Preisgr. A210 (m ²)	
553008-32020H	553008-38110H¹	553008-32050H¹	blau dunkel
Preisgr. A216 (m ²)	Preisgr. A192 (m ²)	Preisgr. A210 (m ²)	
553010-32020H	553010-38110H	553010-32050H¹	türkis hell
Preisgr. A216 (m ²)	Preisgr. A192 (m ²)	Preisgr. A210 (m ²)	
553011-32020H	553011-38110H	553011-32050H	türkis mittel
Preisgr. A216 (m ²)	Preisgr. A192 (m ²)	Preisgr. A210 (m ²)	
553014-32020H	553014-38110H¹	553014-32050H¹	grün hell
Preisgr. A216 (m ²)	Preisgr. A192 (m ²)	Preisgr. A210 (m ²)	
553015-32020H	553015-38110H	553015-32050H	grün mittel
Preisgr. A216 (m ²)	Preisgr. A192 (m ²)	Preisgr. A210 (m ²)	
553016-32020H	553016-38110H	553016-32050H	grün dunkel
Preisgr. A216 (m ²)	Preisgr. A192 (m ²)	Preisgr. A210 (m ²)	
553018-32020H¹	553018-38110H¹	553018-32050H¹	gelb hell
Preisgr. A216 (m ²)	Preisgr. A192 (m ²)	Preisgr. A210 (m ²)	
553019-32020H	553019-38110H	553019-32050H	gelb mittel
Preisgr. A216 (m ²)	Preisgr. A192 (m ²)	Preisgr. A210 (m ²)	
553023-32020H¹	553023-38110H	553023-32050H	ocker mittel
Preisgr. A216 (m ²)	Preisgr. A192 (m ²)	Preisgr. A210 (m ²)	
553026-32020H¹	553026-38110H¹	553026-32050H¹	lachs hell
Preisgr. A216 (m ²)	Preisgr. A192 (m ²)	Preisgr. A210 (m ²)	
553027-32020H¹	553027-38110H	553027-32050H	lachs mittel
Preisgr. A216 (m ²)	Preisgr. A192 (m ²)	Preisgr. A210 (m ²)	
553031-32020H	553031-38110H¹	553031-32050H¹	oxidrot mittel
Preisgr. A216 (m ²)	Preisgr. A192 (m ²)	Preisgr. A210 (m ²)	
553033-32020H¹	553033-38110H¹	553033-32050H¹	steingrau aktiv
Preisgr. A216 (m ²)	Preisgr. A192 (m ²)	Preisgr. A210 (m ²)	
553034-32020H	553034-38110H¹	553034-32050H¹	steingrau hell
Preisgr. A216 (m ²)	Preisgr. A192 (m ²)	Preisgr. A210 (m ²)	
553035-32020H	553035-38110H	553035-32050H¹	steingrau mittel
Preisgr. A216 (m ²)	Preisgr. A192 (m ²)	Preisgr. A210 (m ²)	
553036-32020H	553036-38110H	553036-32050H¹	steingrau dunkel
Preisgr. A216 (m ²)	Preisgr. A192 (m ²)	Preisgr. A210 (m ²)	

¹ Auftragsfertigung: Rückgabe und/oder Stornierung
bestellter Ware nicht möglich.



² Gerundete Kanten / Ecken siehe Seite 113

Trittsicherheit „B“

Bodenfliesen

12,5 x 12,5 cm²



12,5 x 25 cm²



25 x 25 cm²



Lieferung als Doppel-
fliesen; müssen örtlich
gebrochen werden

Formatnummer	32020H	38110H	32050H			
Nennmaß - cm/in	12,5 x 12,5 / 5 x 5	12,5 x 25 / 5 x 10	25 x 25 / 10 x 10			
Herstellmaß	119 x 119 x 8 mm	119 x 244 x 8 mm	244 x 244 x 8 mm			
Oberfläche	eben, seidenmatt	eben, seidenmatt	eben, seidenmatt			
m ² - Stück	64,000	32,000	16,000			
m ² - kg	15,360	15,680	16,960			
Paket - Stück	66	33	14			
Paket - m ²	1,031	1,031	0,875			
Paket - kg	15,840	16,170	14,840			
Palette - m ²	86,625	86,625	70,875			
Palette - kg	1.330,500	1.358,280	1.202,040			
Produktnorm	Alb	Alb	Alb			
Trittsicherheit	-/B	-/B	-/B			
Belastung	2	2	2			
sandgrau aktiv	553037-32020H ¹ Preisgr. A216 (m ²)	553037-38110H ¹ Preisgr. A192 (m ²)	553037-32050H ¹ Preisgr. A210 (m ²)			
sandgrau hell	553038-32020H Preisgr. A216 (m ²)	553038-38110H Preisgr. A192 (m ²)	553038-32050H ¹ Preisgr. A210 (m ²)			
sandgrau mittel	553039-32020H Preisgr. A216 (m ²)	553039-38110H ¹ Preisgr. A192 (m ²)	553039-32050H ¹ Preisgr. A210 (m ²)			
sandgrau dunkel	553040-32020H Preisgr. A216 (m ²)	553040-38110H ¹ Preisgr. A192 (m ²)	553040-32050H ¹ Preisgr. A210 (m ²)			
neutral 9 (weißgrau)	553119-32020H ¹ Preisgr. A216 (m ²)	553119-38110H ¹ Preisgr. A192 (m ²)	553119-32050H Preisgr. A210 (m ²)			
neutral 8 (lichtgrau)	553118-32020H Preisgr. A216 (m ²)	553118-38110H ¹ Preisgr. A192 (m ²)	553118-32050H Preisgr. A210 (m ²)			
neutral 7 (kieselgrau)	553117-32020H Preisgr. A216 (m ²)	553117-38110H Preisgr. A192 (m ²)	553117-32050H Preisgr. A210 (m ²)			
neutral 6 (perlgrau)	553116-32020H ¹ Preisgr. A216 (m ²)	553116-38110H Preisgr. A192 (m ²)	553116-32050H ¹ Preisgr. A210 (m ²)			
neutral 5 (basaltgrau)	553115-32020H ¹ Preisgr. A216 (m ²)	553115-38110H ¹ Preisgr. A192 (m ²)	553115-32050H ¹ Preisgr. A210 (m ²)			
neutral 4 (graphitschwarz)	553114-32020H ¹ Preisgr. A216 (m ²)	553114-38110H ¹ Preisgr. A192 (m ²)	553114-32050H Preisgr. A210 (m ²)			
neutral 3 (asphaltschwarz)	553113-32020H Preisgr. A216 (m ²)	553113-38110H Preisgr. A192 (m ²)	553113-32050H Preisgr. A210 (m ²)			
neutral 2 (anthrazit)	553112-32020H Preisgr. A216 (m ²)	553112-38110H Preisgr. A192 (m ²)	553112-32050H Preisgr. A210 (m ²)			
kontrastrot	77i-32020H Preisgr. A216 (m ²)	77i-38110H Preisgr. A192 (m ²)	77i-32050H Preisgr. A210 (m ²)			



¹ Auftragsfertigung: Rückgabe und/oder Stornierung bestellter Ware nicht möglich.

² Gerundete Kanten / Ecken siehe S. 113

Trittsicherheit „B“ – gerundete Kanten/Ecken^{1/2}

Bodenfliesen

12,5 x 12,5 cm



12,5 x 12,5 cm



12,5 x 25 cm



12,5 x 25 cm



12,5 x 25 cm



12,5 x 25 cm



gerundete Kante	gerundete Ecke	gerundete Kopfkante	gerundete Längskante	gerundete Ecke links	gerundete Ecke rechts
32025H	32027H	38115H	38116H	38117H	38118H
12,5 x 12,5 / 5 x 5	12,5 x 12,5 / 5 x 5	12,5 x 25 / 5 x 10	12,5 x 25 / 5 x 10	12,5 x 25 / 5 x 10	12,5 x 25 / 5 x 10
119 x 119 x 8 mm	119 x 119 x 8 mm	119 x 244 x 8 mm	119 x 244 x 8 mm	119 x 244 x 8 mm	119 x 244 x 8 mm
eben, seidenmatt	eben, seidenmatt	eben, seidenmatt	eben, seidenmatt	eben, seidenmatt	eben, seidenmatt
0,240	0,240	0,490	0,490	0,490	0,490
66	66	33	33	33	33
15,840	15,840	16,170	16,170	16,170	16,170
Alb	Alb	Alb	Alb	Alb	Alb
-/B	-/B	-/B	-/B	-/B	-/B
2	2	2	2	2	2
91i-32025H	91i-32027H	91i-38115H	91i-38116H	91i-38117H	91i-38118H
Preisgr. A410 (St.)	Preisgr. A410 (St.)	Preisgr. A416 (St.)	Preisgr. A416 (St.)	Preisgr. A416 (St.)	Preisgr. A416 (St.)
340i-32025H	340i-32027H	340i-38115H	340i-38116H	340i-38117H	340i-38118H
Preisgr. A410 (St.)	Preisgr. A410 (St.)	Preisgr. A416 (St.)	Preisgr. A416 (St.)	Preisgr. A416 (St.)	Preisgr. A416 (St.)
553001-32025H	553001-32027H	553001-38115H	553001-38116H	553001-38117H	553001-38118H
Preisgr. A410 (St.)	Preisgr. A410 (St.)	Preisgr. A416 (St.)	Preisgr. A416 (St.)	Preisgr. A416 (St.)	Preisgr. A416 (St.)
553002-32025H	553002-32027H	553002-38115H	553002-38116H	553002-38117H	553002-38118H
Preisgr. A410 (St.)	Preisgr. A410 (St.)	Preisgr. A416 (St.)	Preisgr. A416 (St.)	Preisgr. A416 (St.)	Preisgr. A416 (St.)



Formatnummer
Nennmaß - cm/in
Herstellmaß
Oberfläche
m ² - Stück
Stück - kg
Paket - Stück
Paket - m ²
Paket - kg
Palette - m ²
Palette - kg
Produktnorm
Trittsicherheit
Belastung
neutral 10
(aktivweiß)
neutral 1
(tiefschwarz)
azur aktiv
azur hell

25 x 25 cm



25 x 25 cm



gerundete Kante	gerundete Ecke
32055H	32057H
25 x 25 / 10 x 10	25 x 25 / 10 x 10
244 x 244 x 8 mm	244 x 244 x 8 mm
eben, seidenmatt	eben, seidenmatt
1,060	1,060
14	14
14,840	14,840
Alb	Alb
-/B	-/B
2	2
91i-32055H	91i-32057H
Preisgr. A434 (St.)	Preisgr. A434 (St.)
340i-32055H	340i-32057H
Preisgr. A434 (St.)	Preisgr. A434 (St.)
553001-32055H	553001-32057H
Preisgr. A434 (St.)	Preisgr. A434 (St.)
553002-32055H	553002-32057H
Preisgr. A434 (St.)	Preisgr. A434 (St.)



Formatnummer
Nennmaß - cm/in
Herstellmaß
Oberfläche
m ² - Stück
Stück - kg
Paket - Stück
Paket - m ²
Paket - kg
Palette - m ²
Palette - kg
Produktnorm
Trittsicherheit
Belastung
neutral 10
(aktivweiß)
neutral 1
(tiefschwarz)
azur aktiv
azur hell

¹ weitere Farben auf Anfrage lieferbar
² Auftragsfertigung: Rückgabe und/oder Stornierung bestellter Ware nicht möglich.



Gerundete Kanten

Grundformat-Nr. statt Endziffer 0 Endziffer ...

... 7 = Ecke links

... 8 = Ecke rechts

gerundete Kanten

Beispiel: Grundformat-Nr. 38110 = 119 x 244 x 6 mm,
Format-Nr. 38117 = gerundete Ecke links

Trittsicherheit „C“

-/C



weiß / neutral 10
(aktivweiß)

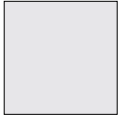

neutral 9
(weißgrau)



neutral 8
(lichtgrau)



neutral 7
(kieselgrau)



neutral 3
(asphaltschwarz)



schwarz / neutral 1
(tiefschwarz)

-/C



azur dunkel



azur mittel



azur hell



blau dunkel



blau mittel



blau hell



türkis mittel



türkis hell



grün dunkel



grün mittel



grün hell



gelb mittel



ocker mittel



lachs mittel



lachs hell



oxidrot mittel



steingrau dunkel



steingrau mittel



sandgrau dunkel



sandgrau mittel



sandgrau hell

-/C



azur aktiv

-/C



kontrastrot



Bodenfliese
12,5 x 12,5 cm



Bodenfliese
12,5 x 25 cm



Bodenfliese
25 x 25 cm

Auf Anfrage sind
weitere Farben
der Serie Chroma
als non-slip Glasur
in 6 mm Fugenbreite
lieferbar.

Trittsicherheit „C“
Bodenfliesen

12,5 x 12,5 cm²



12,5 x 25 cm²



25 x 25 cm²



Lieferung als Doppel-
fliesen; müssen örtlich
gebrochen werden



	32020H	38110H	32050H	Formatnummer
	12,5 x 12,5 / 5 x 5	12,5 x 25 / 5 x 10	25 x 25 / 10 x 10	Nennmaß - cm/in
	119 x 119 x 8 mm	119 x 244 x 8 mm	244 x 244 x 8 mm	Herstellmaß
	strukturiert, seidenmatt	strukturiert, seidenmatt	strukturiert, seidenmatt	Oberfläche
	64,000	32,000	16,000	m ² - Stück
	15,360	15,680	16,960	m ² - kg
	66	33	14	Paket - Stück
	1,031	1,031	0,875	Paket - m ²
	15,840	16,170	14,840	Paket - kg
	86,625	86,625	70,875	Palette - m ²
	1.330,560	1.358,280	1.202,040	Palette - kg
	Alb	Alb	Alb	Produktnorm
	-/C	-/C	-/C	Trittsicherheit
	2	2	2	Belastung
	81i-32020H	81i-38110H	81i-32050H	neutral 10
	Preisgr. A216 (m ²)	Preisgr. A192 (m ²)	Preisgr. A210 (m ²)	(aktivweiß)
	554111-32020H	554111-38110H	554111-32050H¹	neutral 1
	Preisgr. A216 (m ²)	Preisgr. A192 (m ²)	Preisgr. A210 (m ²)	(tiefschwarz)
	554001-32020H	554001-38110H	554001-32050H¹	azur aktiv
	Preisgr. A216 (m ²)	Preisgr. A192 (m ²)	Preisgr. A210 (m ²)	
	554002-32020H	554002-38110H	554002-32050H	azur hell
	Preisgr. A216 (m ²)	Preisgr. A192 (m ²)	Preisgr. A210 (m ²)	
	554003-32020H	554003-38110H	554003-32050H	azur mittel
	Preisgr. A216 (m ²)	Preisgr. A192 (m ²)	Preisgr. A210 (m ²)	
	554004-32020H	554004-38110H	554004-32050H¹	azur dunkel
	Preisgr. A216 (m ²)	Preisgr. A192 (m ²)	Preisgr. A210 (m ²)	
	554006-32020H	554006-38110H	554006-32050H¹	blau hell
	Preisgr. A216 (m ²)	Preisgr. A192 (m ²)	Preisgr. A210 (m ²)	
	554007-32020H	554007-38110H	554007-32050H¹	blau mittel
	Preisgr. A216 (m ²)	Preisgr. A192 (m ²)	Preisgr. A210 (m ²)	
	554008-32020H	554008-38110H	554008-32050H¹	blau dunkel
	Preisgr. A216 (m ²)	Preisgr. A192 (m ²)	Preisgr. A210 (m ²)	
	554010-32020H	554010-38110H	554010-32050H¹	türkis hell
	Preisgr. A216 (m ²)	Preisgr. A192 (m ²)	Preisgr. A210 (m ²)	
	554011-32020H	554011-38110H	554011-32050H¹	türkis mittel
	Preisgr. A216 (m ²)	Preisgr. A192 (m ²)	Preisgr. A210 (m ²)	
	554014-32020H	554014-38110H¹	554014-32050H¹	grün hell
	Preisgr. A216 (m ²)	Preisgr. A192 (m ²)	Preisgr. A210 (m ²)	
	554015-32020H	554015-38110H¹	554015-32050H¹	grün mittel
	Preisgr. A216 (m ²)	Preisgr. A192 (m ²)	Preisgr. A210 (m ²)	
	554016-32020H	554016-38110H	554016-32050H	grün dunkel
	Preisgr. A216 (m ²)	Preisgr. A192 (m ²)	Preisgr. A210 (m ²)	
	554019-32020H	554019-38110H	554019-32050H¹	gelb mittel
	Preisgr. A216 (m ²)	Preisgr. A192 (m ²)	Preisgr. A210 (m ²)	
	554023-32020H	554023-38110H	554023-32050H	ocker mittel
	Preisgr. A216 (m ²)	Preisgr. A192 (m ²)	Preisgr. A210 (m ²)	
	554026-32020H¹	554026-38110H¹	554026-32050H¹	lachs hell
	Preisgr. A216 (m ²)	Preisgr. A192 (m ²)	Preisgr. A210 (m ²)	
	554027-32020H	554027-38110H	554027-32050H¹	lachs mittel
	Preisgr. A216 (m ²)	Preisgr. A192 (m ²)	Preisgr. A210 (m ²)	
	554031-32020H	554031-38110H	554031-32050H¹	oxidrot mittel
	Preisgr. A216 (m ²)	Preisgr. A192 (m ²)	Preisgr. A210 (m ²)	
	554035-32020H	554035-38110H	554035-32050H¹	steingrau mittel
	Preisgr. A216 (m ²)	Preisgr. A192 (m ²)	Preisgr. A210 (m ²)	
	554036-32020H	554036-38110H	554036-32050H¹	steingrau dunkel
	Preisgr. A216 (m ²)	Preisgr. A192 (m ²)	Preisgr. A210 (m ²)	
	554038-32020H	554038-38110H	554038-32050H	sandgrau hell
	Preisgr. A216 (m ²)	Preisgr. A192 (m ²)	Preisgr. A210 (m ²)	
	554039-32020H	554039-38110H	554039-32050H¹	sandgrau mittel
	Preisgr. A216 (m ²)	Preisgr. A192 (m ²)	Preisgr. A210 (m ²)	
	554040-32020H	554040-38110H	554040-32050H¹	sandgrau dunkel
	Preisgr. A216 (m ²)	Preisgr. A192 (m ²)	Preisgr. A210 (m ²)	
	554119-32020H¹	554119-38110H	554119-32050H¹	neutral 9
	Preisgr. A216 (m ²)	Preisgr. A192 (m ²)	Preisgr. A210 (m ²)	(weißgrau)
	554118-32020H	554118-38110H	554118-32050H¹	neutral 8
	Preisgr. A216 (m ²)	Preisgr. A192 (m ²)	Preisgr. A210 (m ²)	(lichtgrau)
	554117-32020H	554117-38110H	554117-32050H	neutral 7
	Preisgr. A216 (m ²)	Preisgr. A192 (m ²)	Preisgr. A210 (m ²)	(kieselgrau)
	554113-32020H	554113-38110H	554113-32050H	neutral 3
	Preisgr. A216 (m ²)	Preisgr. A192 (m ²)	Preisgr. A210 (m ²)	(asphaltschwarz)
	78i-32020H	78i-38110H	78i-32050H¹	kontrastrot
	Preisgr. A216 (m ²)	Preisgr. A192 (m ²)	Preisgr. A210 (m ²)	

¹ Auftragsfertigung: Rückgabe und/oder Stornierung
bestellter Ware nicht möglich.

² Gerundete Kanten / Ecken siehe S. 116



Trittsicherheit „C“ – gerundete Kanten/Ecken^{1/2}

Bodenfliesen

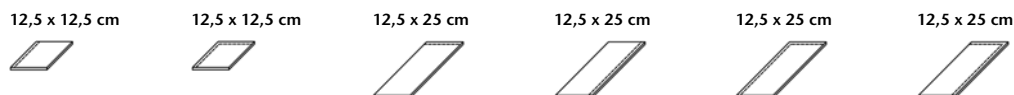

	gerundete Kante	gerundete Ecke	gerundete Kopfkante	gerundete Längskante	gerundete Ecke links	gerundete Ecke rechts
Formatnummer	32025H	32027H	38115H	38116H	38117H	38118H
Nennmaß - cm/in	12,5 x 12,5 / 5 x 5	12,5 x 12,5 / 5 x 5	12,5 x 25 / 5 x 10	12,5 x 25 / 5 x 10	12,5 x 25 / 5 x 10	12,5 x 25 / 5 x 10
Herstellmaß	119 x 119 x 8 mm	119 x 119 x 8 mm	119 x 244 x 8 mm	119 x 244 x 8 mm	119 x 244 x 8 mm	119 x 244 x 8 mm
Oberfläche	strukturiert, seidenmatt	strukturiert, seidenmatt	strukturiert, seidenmatt	strukturiert, seidenmatt	strukturiert, seidenmatt	strukturiert, seidenmatt
m ² - Stück						
Stück - kg	0,240	0,240	0,490	0,490	0,490	0,490
Paket - Stück	66	66	33	33	33	33
Paket - m ²						
Paket - kg	15,840	15,840	16,170	16,170	16,170	16,170
Palette - m ²						
Palette - kg						
Produktnorm	Alb	Alb	Alb	Alb	Alb	Alb
Trittsicherheit	-/C	-/C	-/C	-/C	-/C	-/C
Belastung	2	2	2	2	2	2
neutral 10 (aktivweiß)	81i-32025H Preisgr. A410 (St.)	81i-32027H Preisgr. A410 (St.)	81i-38115H Preisgr. A416 (St.)	81i-38116H Preisgr. A416 (St.)	81i-38117H Preisgr. A416 (St.)	81i-38118H Preisgr. A416 (St.)
neutral 1 (tiefschwarz)	554111-32025H Preisgr. A410 (St.)	554111-32027H Preisgr. A410 (St.)	554111-38115H Preisgr. A416 (St.)	554111-38116H Preisgr. A416 (St.)	554111-38117H Preisgr. A416 (St.)	554111-38118H Preisgr. A416 (St.)
azur aktiv	554001-32025H Preisgr. A410 (St.)	554001-32027H Preisgr. A410 (St.)	554001-38115H Preisgr. A416 (St.)	554001-38116H Preisgr. A416 (St.)	554001-38117H Preisgr. A416 (St.)	554001-38118H Preisgr. A416 (St.)
azur hell	554002-32025H Preisgr. A410 (St.)	554002-32027H Preisgr. A410 (St.)	554002-38115H Preisgr. A416 (St.)	554002-38116H Preisgr. A416 (St.)	554002-38117H Preisgr. A416 (St.)	554002-38118H Preisgr. A416 (St.)



¹ weitere Farben auf Anfrage lieferbar

² Auftragsfertigung: Rückgabe und/oder Stornierung bestellter Ware nicht möglich.

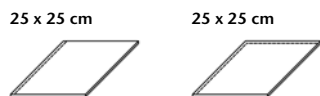

	gerundete Kante	gerundete Ecke
Formatnummer	32055H	32057H
Nennmaß - cm/in	25 x 25 / 10 x 10	25 x 25 / 10 x 10
Herstellmaß	244 x 244 x 8 mm	244 x 244 x 8 mm
Oberfläche	strukturiert, seidenmatt	strukturiert, seidenmatt
m ² - Stück		
Stück - kg	1,060	1,060
Paket - Stück	14	14
Paket - m ²		
Paket - kg	14,840	14,840
Palette - m ²		
Palette - kg		
Produktnorm	Alb	Alb
Trittsicherheit	-/C	-/C
Belastung	2	2
neutral 10 (aktivweiß)	81i-32055H Preisgr. A434 (St.)	81i-32057H Preisgr. A434 (St.)
neutral 1 (tiefschwarz)	554111-32055H Preisgr. A434 (St.)	554111-32057H Preisgr. A434 (St.)
azur aktiv	554001-32055H Preisgr. A434 (St.)	554001-32057H Preisgr. A434 (St.)
azur hell	554002-32055H Preisgr. A434 (St.)	554002-32057H Preisgr. A434 (St.)



¹ weitere Farben auf Anfrage lieferbar

² Auftragsfertigung: Rückgabe und/oder Stornierung bestellter Ware nicht möglich.

Gerundete Kanten			gerundete Kanten
Grundformat-Nr. statt Endziffer 0 Endziffer 7 = Ecke links	... 8 = Ecke rechts	Beispiel: Grundformat-Nr. 38110 = 119 x 244 x 6 mm, Format-Nr. 38117 = gerundete Ecke links



Projekt: Oasia Hotel / Standort: Singapur / Architekt: WOHA Architects + Patricia Urquiola / Serie: Chroma non-slip, Chroma / Foto: Infinitude





Projekt: Hart van Zuid / Standort: Rotterdam, Niederlande / Architekt: Kraaijvanger architects /
Serie: Chroma / Foto: Marcel van der Burg







Quantum



weiß / neutral 10
(aktivweiß)



ocker mittel

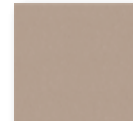

Boden-/Wandfliese
12,5 x 12,5 cm



neutral 8
(lichtgrau)



steingrau dunkel



steingrau mittel

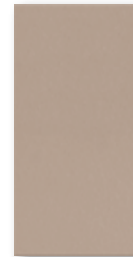

Boden-/Wandfliese
12,5 x 25 cm



neutral 7
(kieselgrau)



sandgrau dunkel



sandgrau mittel



sandgrau hell



neutral 3
(asphaltschwarz)



schwarz / neutral 1
(tiefschwarz)

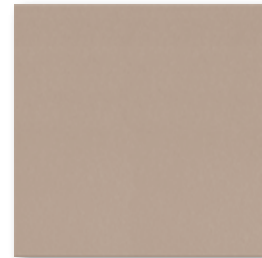

Boden-/Wandfliese
25 x 25 cm

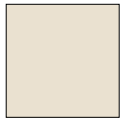

naturweiß

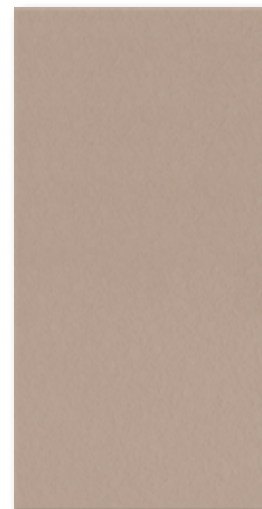

Boden-/Wandfliese
25 x 50 cm

Rasterprofil

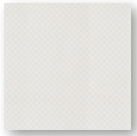

Rasterprofilfliese
12,5 x 12,5 cm

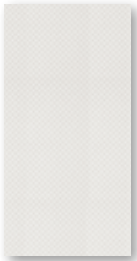

Rasterprofilfliese
12,5 x 25 cm

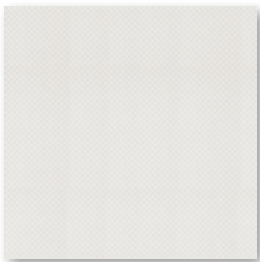

Rasterprofilfliese
25 x 25 cm



Rasterprofilfliese
25 x 50 cm

Duschtassensystem

Duschtassensystem
Ecke (einteilig)
12,5 x 12,5 cm



Duschtassensystem
Läufer
12,5 x 12,5 cm

Duschtassensystem
Läufer
25 x 12,5 cm

Kehlsockel, r = 12 mm,
25 x 12,5 cm



Außenecke,
Gehrungspaar

Innenecke,
Gehrungspaar

 Auf Anfrage sind weitere Farben der Serie Chroma unglasiert in 6 mm Fugenbreite lieferbar.

Quantum

Boden-/Wandfliesen

12,5 x 12,5 cm



12,5 x 25 cm



25 x 25 cm



25 x 50 cm²

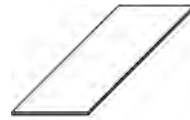

Lieferung als Doppel-
fliesen; müssen örtlich
gebrochen werden

Formatnummer	32020H	38110H	32050H	42550HK			
Nennmaß - cm/in	12,5 x 12,5 / 5 x 5	12,5 x 25 / 5 x 10	25 x 25 / 10 x 10	25 x 50 / 10 x 20			
Herstellmaß	119 x 119 x 8 mm	119 x 244 x 8 mm	244 x 244 x 8 mm	244 x 494 x 8 mm			
Oberfläche	eben, seidenmatt	eben, seidenmatt	eben, seidenmatt	eben, seidenmatt			
m ² - Stück	64,000	32,000	16,000	8,000			
m ² - kg	15,360	15,680	16,960	17,040			
Paket - Stück	66	33	14	9			
Paket - m ²	1,031	1,031	0,875	1,125			
Paket - kg	15,840	16,170	14,840	19,170			
Palette - m ²	86,625	86,625	70,875	40,500			
Palette - kg	1.330,560	1.358,280	1.202,040	690,120			
Produktnorm	Alb	Alb	Alb	Alb			
Trittsicherheit	R10/A	R10/A	R10/A	R10/A			
Belastung	2	2	2	2			
neutral 10 (aktivweiß)	926i-32020H Preisgr. A230 (m ²)	926i-38110H Preisgr. A197 (m ²)	926i-32050H Preisgr. A230 (m ²)	926i-42550HK¹ Preisgr. A230 (m ²)			
neutral 1 (tiefschwarz)	918i-32020H Preisgr. A230 (m ²)	918i-38110H Preisgr. A197 (m ²)	918i-32050H Preisgr. A230 (m ²)	918i-42550HK¹ Preisgr. A230 (m ²)			
ocker mittel	555023-32020H¹ Preisgr. A230 (m ²)	555023-38110H¹ Preisgr. A197 (m ²)	555023-32050H¹ Preisgr. A230 (m ²)	555023-42550HK¹ Preisgr. A230 (m ²)			
steingrau mittel	555035-32020H¹ Preisgr. A230 (m ²)	555035-38110H¹ Preisgr. A197 (m ²)	555035-32050H¹ Preisgr. A230 (m ²)	555035-42550HK¹ Preisgr. A230 (m ²)			
steingrau dunkel	555036-32020H¹ Preisgr. A230 (m ²)	555036-38110H¹ Preisgr. A197 (m ²)	555036-32050H¹ Preisgr. A230 (m ²)	555036-42550HK¹ Preisgr. A230 (m ²)			
sandgrau hell	555038-32020H¹ Preisgr. A230 (m ²)	555038-38110H¹ Preisgr. A197 (m ²)	555038-32050H¹ Preisgr. A230 (m ²)	555038-42550HK¹ Preisgr. A230 (m ²)			
sandgrau mittel	555039-32020H¹ Preisgr. A230 (m ²)	555039-38110H¹ Preisgr. A197 (m ²)	555039-32050H¹ Preisgr. A230 (m ²)	555039-42550HK¹ Preisgr. A230 (m ²)			
sandgrau dunkel	555040-32020H¹ Preisgr. A230 (m ²)	555040-38110H¹ Preisgr. A197 (m ²)	555040-32050H¹ Preisgr. A230 (m ²)	555040-42550HK¹ Preisgr. A230 (m ²)			
neutral 3 (asphaltschwarz)	555113-32020H¹ Preisgr. A230 (m ²)	555113-38110H¹ Preisgr. A197 (m ²)	555113-32050H¹ Preisgr. A230 (m ²)	555113-42550HK¹ Preisgr. A230 (m ²)			
neutral 7 (kieselgrau)	555117-32020H¹ Preisgr. A230 (m ²)	555117-38110H¹ Preisgr. A197 (m ²)	555117-32050H¹ Preisgr. A230 (m ²)	555117-42550HK¹ Preisgr. A230 (m ²)			
neutral 8 (lichtgrau)	555118-32020H¹ Preisgr. A230 (m ²)	555118-38110H¹ Preisgr. A197 (m ²)	555118-32050H¹ Preisgr. A230 (m ²)	555118-42550HK¹ Preisgr. A230 (m ²)			
naturweiß	901i-32020H Preisgr. A230 (m ²)	901i-38110H Preisgr. A197 (m ²)	901i-32050H Preisgr. A230 (m ²)	901i-42550HK¹ Preisgr. A230 (m ²)			



¹  Auftragsfertigung: Rückgabe und/oder Stornierung bestellter Ware nicht möglich.

²  rektifiziert

Quantum

Bodenfliesen/Rasterprofilfliesen

12,5 x 12,5 cm



12,5 x 25 cm



25 x 25 cm



25 x 50 cm²

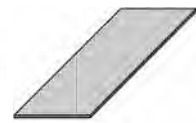

Rasterprofilfliese;
Lieferung als Doppel-
fliesen; müssen örtlich
gebrochen werden



	Rasterprofilfliese	Rasterprofilfliese	Rasterprofilfliese	
32100H	34090H	32080H	42580HK	Formatnummer
12,5 x 12,5 / 5 x 5	12,5 x 25 / 5 x 10	25 x 25 / 10 x 10	25 x 50 / 10 x 20	Nennmaß - cm/in
119 x 119 x 8 mm	119 x 244 x 8 mm	244 x 244 x 8 mm	244 x 494 x 8 mm	Herstellmaß
reliefiert, seidenmatt	reliefiert, seidenmatt	reliefiert, seidenmatt	reliefiert, seidenmatt	Oberfläche
64,000	32,000	16,000	8,000	m ² - Stück
15,360	15,360	16,800	17,040	m ² - kg
66	33	14	9	Paket - Stück
1,031	1,031	0,875	1,125	Paket - m ²
15,840	15,840	14,700	19,170	Paket - kg
86,625	86,625	70,875	40,500	Palette - m ²
1.330,560	1.330,560	1.190,700	690,120	Palette - kg
Alb	Alb	Alb	Alb	Produktnorm
R11/B	R11/B	R11/B	R11/B	Trittsicherheit
2	2	2	2	Belastung
926i-32100H	926i-34090H	926i-32080H	926i-42580HK¹	neutral 10
Preisgr. A241 (m ²)	Preisgr. A216 (m ²)	Preisgr. A241 (m ²)	Preisgr. A241 (m ²)	(aktivweiß)
918i-32100H	918i-34090H	918i-32080H	918i-42580HK¹	neutral 1
Preisgr. A241 (m ²)	Preisgr. A216 (m ²)	Preisgr. A241 (m ²)	Preisgr. A241 (m ²)	(tiefschwarz)
555023-32100H¹	555023-34090H¹	555023-32080H¹	555023-42580HK¹	ocker mittel
Preisgr. A241 (m ²)	Preisgr. A216 (m ²)	Preisgr. A241 (m ²)	Preisgr. A241 (m ²)	
555035-32100H¹	555035-34090H¹	555035-32080H¹	555035-42580HK¹	steingrau mittel
Preisgr. A241 (m ²)	Preisgr. A216 (m ²)	Preisgr. A241 (m ²)	Preisgr. A241 (m ²)	
555036-32100H¹	555036-34090H¹	555036-32080H¹	555036-42580HK¹	steingrau dunkel
Preisgr. A241 (m ²)	Preisgr. A216 (m ²)	Preisgr. A241 (m ²)	Preisgr. A241 (m ²)	
555038-32100H¹	555038-34090H¹	555038-32080H¹	555038-42580HK¹	sandgrau hell
Preisgr. A241 (m ²)	Preisgr. A216 (m ²)	Preisgr. A241 (m ²)	Preisgr. A241 (m ²)	
555039-32100H¹	555039-34090H¹	555039-32080H¹	555039-42580HK¹	sandgrau mittel
Preisgr. A241 (m ²)	Preisgr. A216 (m ²)	Preisgr. A241 (m ²)	Preisgr. A241 (m ²)	
555040-32100H¹	555040-34090H¹	555040-32080H¹	555040-42580HK¹	sandgrau dunkel
Preisgr. A241 (m ²)	Preisgr. A216 (m ²)	Preisgr. A241 (m ²)	Preisgr. A241 (m ²)	
555113-32100H¹	555113-34090H¹	555113-32080H¹	555113-42580HK¹	neutral 3
Preisgr. A241 (m ²)	Preisgr. A216 (m ²)	Preisgr. A241 (m ²)	Preisgr. A241 (m ²)	(asphaltschwarz)
555117-32100H¹	555117-34090H¹	555117-32080H¹	555117-42580HK¹	neutral 7
Preisgr. A241 (m ²)	Preisgr. A216 (m ²)	Preisgr. A241 (m ²)	Preisgr. A241 (m ²)	(kieselgrau)
555118-32100H¹	555118-34090H¹	555118-32080H¹	555118-42580HK¹	neutral 8
Preisgr. A241 (m ²)	Preisgr. A216 (m ²)	Preisgr. A241 (m ²)	Preisgr. A241 (m ²)	(lichtgrau)
901i-32100H	901i-34090H	901i-32080H	901i-42580HK¹	naturweiß
Preisgr. A241 (m ²)	Preisgr. A216 (m ²)	Preisgr. A241 (m ²)	Preisgr. A241 (m ²)	

¹ Auftragsfertigung: Rückgabe und/oder Stornierung bestellter Ware nicht möglich.

² rektifiziert



Quantum

Duschtassensystem¹

12,5 x 25 cm



12,5 x 12,5 cm



12,5 x 12,5 cm



Schwallkante 10 mm

Schwallkante 10 mm



	Läufer	Läufer	Ecke			
Formatnummer	27182H	27180H	27181H			
Nennmaß - cm/in	12,5 x 25 / 5 x 10	12,5 x 12,5 / 5 x 5	12,5 x 12,5 / 5 x 5			
Herstellmaß	119 x 244 x 18/8 mm	119 x 119 x 18/8 mm	119 x 119 x 18/8 mm			
Oberfläche	eben, seidenmatt	eben, seidenmatt	eben, seidenmatt			
m - Stück	4,000	8,000				
m/St. - kg	2,720/m	2,720/m	0,500/Stück			
Paket - Stück	22	44	12			
Paket - m	5,500	5,500				
Paket - kg	14,960	14,960	6,000			
Palette - m						
Palette - kg						
Produktnorm	Alb	Alb	Alb			
Trittsicherheit	R10/B	R10/B	R10/B			
neutral 10	926i-27182H	926i-27180H	926i-27181H			
(aktivweiß)	Preisgr. A506 (St.)	Preisgr. A455 (St.)	Preisgr. A489 (St.)			
neutral 1	918i-27182H	918i-27180H	918i-27181H			
(tiefschwarz)	Preisgr. A506 (St.)	Preisgr. A455 (St.)	Preisgr. A489 (St.)			
	555023-27182H ²	555023-27180H ²	555023-27181H ²			
ocker mittel	Preisgr. A506 (St.)	Preisgr. A455 (St.)	Preisgr. A489 (St.)			
	555035-27182H ²	555035-27180H ²	555035-27181H ²			
steingrau mittel	Preisgr. A506 (St.)	Preisgr. A455 (St.)	Preisgr. A489 (St.)			
	555036-27182H ²	555036-27180H ²	555036-27181H ²			
steingrau dunkel	Preisgr. A506 (St.)	Preisgr. A455 (St.)	Preisgr. A489 (St.)			
	555038-27182H ²	555038-27180H ²	555038-27181H ²			
sandgrau hell	Preisgr. A506 (St.)	Preisgr. A455 (St.)	Preisgr. A489 (St.)			
	555039-27182H ²	555039-27180H ²	555039-27181H ²			
sandgrau mittel	Preisgr. A506 (St.)	Preisgr. A455 (St.)	Preisgr. A489 (St.)			
	555040-27182H ²	555040-27180H ²	555040-27181H ²			
sandgrau dunkel	Preisgr. A506 (St.)	Preisgr. A455 (St.)	Preisgr. A489 (St.)			
neutral 3	555113-27182H ²	555113-27180H ²	555113-27181H ²			
(asphaltschwarz)	Preisgr. A506 (St.)	Preisgr. A455 (St.)	Preisgr. A489 (St.)			
neutral 7	555117-27182H ²	555117-27180H ²	555117-27181H ²			
(kieselgrau)	Preisgr. A506 (St.)	Preisgr. A455 (St.)	Preisgr. A489 (St.)			
neutral 8	555118-27182H ²	555118-27180H ²	555118-27181H ²			
(lichtgrau)	Preisgr. A506 (St.)	Preisgr. A455 (St.)	Preisgr. A489 (St.)			
naturweiß	901i-27182H	901i-27180H	901i-27181H			
	Preisgr. A506 (St.)	Preisgr. A455 (St.)	Preisgr. A489 (St.)			



¹ Details siehe S. 482

²  Auftragsfertigung: Rückgabe und/oder Stornierung bestellter Ware nicht möglich.

Diese Formstücke sind nicht durchgefärbt.

Quantum

Sicherheitsriemchen^{1/2}

6,2 x 25 cm



Längskante
gerundet

Sockelsysteme²

7,9 x 25 cm



12,5 x 25 cm



Außenecke
Gehrungspaar

Innenecke
Gehrungspaar

Längskante gerundet	34020H	34020H	37080	37081	37082	Formatnummer
6,2 x 25 / 2 1/2 x 10	7,9 x 25 / 3 1/8 x 10	7,9 x 25 / 3 1/8 x 10	12,5 x 25 / 5 x 10	(2x) 131 x 125/12 x 8 mm	(2x) 119 x 125/12 x 8 mm	Nennmaß - cm/in
56 x 244 x 8 mm	73 x 244 x 8 mm	73 x 244 x 8 mm	125 x 244/12 x 8 mm	eben, seidenmatt	eben, seidenmatt	Herstellmaß
gerillt, seidenmatt	eben, seidenmatt	eben, seidenmatt	eben, seidenmatt			Oberfläche
4,000	4,000	4,000	4,000			m - Stück
0,800/m	1,160/m	1,160/m	2,520/m	0,600/Paar	0,400/Paar	m/Paar - kg
66 Stück	33 Stück	33 Stück	20 Stück	10 Paar	10 Paar	Paket - St./Paar
16,500	8,250	8,250	5,000			Paket - m
13,200	9,570	9,570	12,600	6,000	4,000	Paket - kg
						Palette - m
						Palette - kg
Alb	Alb	Alb	Alb	Alb	Alb	Produktnorm
-/C						Trittsicherheit
	926i-34020H	926i-34020H	926-37080	926-37081	926-37082	neutral 10
	Preisgr. A410 (St.)	Preisgr. A410 (St.)	Preisgr. A423 (St.)	Preisgr. A455 (Paar)	Preisgr. A455 (Paar)	(aktivweiß)
	918i-34020H	918i-34020H	918-37080	918-37081	918-37082	neutral 1
	Preisgr. A410 (St.)	Preisgr. A410 (St.)	Preisgr. A423 (St.)	Preisgr. A455 (Paar)	Preisgr. A455 (Paar)	(tiefschwarz)
	901i-34020H	901i-34020H	901-37080	901-37081	901-37082	naturweiß
	Preisgr. A410 (St.)	Preisgr. A410 (St.)	Preisgr. A423 (St.)	Preisgr. A455 (Paar)	Preisgr. A455 (Paar)	

¹ Besonders geeignet zur trittsicheren und deutlich wahrnehmbaren Gestaltung von (Treppen-)Kanten.

² weitere Farben auf Anfrage lieferbar

Diese Formstücke sind nicht durchgefärbt



Projekt: Bar Bardem / Standort: Helsinki, Finland / Architekt: Fyra Ltd. / Serie: Craft / Foto: Riikka Kantinkoski





Inspirierend und modern

Der seit Jahren anhaltende Heritage Hype in Mode, Lifestyle und Technik geht auch an Fliesen nicht vorüber. Craft zitiert Vertrautes und wirkt doch überraschend modern: Die für Innen- und Außenbereiche gleichermaßen geeignete Serie verdankt ihren handwerklichen Charakter der Tiefe und Transparenz ihrer hochglänzenden Glasur. Kompositionen von Erdalkalien, Flussmitteln und Metalloxiden im Zusammenspiel mit dem Tonkörper lassen bei offener Flammführung besonders leuchtende, intensive Kolorationen und die typischen Oberflächenstrukturen entstehen.

Unifarben

Geflamnte Farben

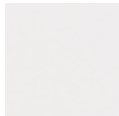

reinweiß



weiß



mittelgrau

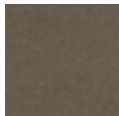

dunkelgrau



jadegrün



beryllrot



benitblau



hämatitschwarz



olivgrün geflamnt



goldgelb geflamnt



amber geflamnt



blaugrün geflamnt

Naturkeramik Farben



goldocker



goldcreme



goldgrau

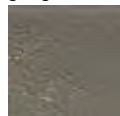

goldschwarz



tabak



Riemchen 8,3 x 25 cm



Riemchen 6,2 x 25 cm



Riemchen Wellenprofil 6,2 x 25 cm



Riemchen Rillenprofil 6,2 x 25 cm

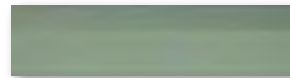

Riemchen Spitzprofil 6,2 x 25 cm



Doppelspitzplatte 12,5 x 25 cm



Abdeckplatte Tropfkante 25 x 30 cm



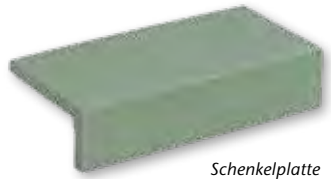

Schenkelplatte
12,5 x 25 cm

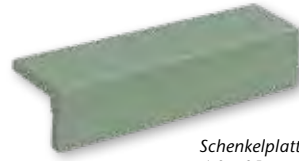

Schenkelplatte
6,2 x 25 cm

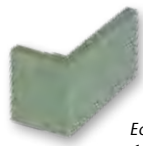

Eckstück
6,2 x 12,5 / 6,2 x 1,1 cm

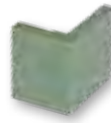

Eckstück
6,2 x 6,2 / 6,2 x 1,1 cm



Riemchen 6,2 x 25 cm



Riemchen Wellenprofil 6,2 x 25 cm



Doppelspitzplatte 12,5 x 25 cm



Riemchen Spitzprofil 6,2 x 25 cm



Riemchen Rillenprofil 6,2 x 25 cm

Riemchen³

Doppelspitzplatte

8,3 x 25 cm^{1/2}



6,2 x 25 cm²



6,2 x 25 cm^{1/2}



6,2 x 25 cm^{1/2}



6,2 x 25 cm^{1/2}



12,5 x 25 cm¹



Wellenprofil

Spitzprofil
asym.

Rillenprofil
(A&B Seite)

	2110	2120	2250	2270	2280	2240	Formatnummer
	8,3 x 25 / 3 5/16 x 10	6,2 x 25 / 2 1/2 x 10	6,2 x 25 / 2 1/2 x 10	6,2 x 25 / 2 1/2 x 10	6,2 x 25 / 2 1/2 x 10	12,5 x 25 / 5 x 10	Nennmaß - cm/in
	73 x 240 x 11 mm	52 x 240 x 11 mm	52 x 240 x 16/11 mm	52 x 240 x 18/11 mm	52 x 240 x 11 mm	115 x 240 x 20/11 mm	Herstellmaß
	gehämmert, matt ⁴	eben, glänzend ⁴	eben, glänzend	eben, glänzend	eben, glänzend	eben, glänzend	Oberfläche
	50,000	67,000	67,000	67,000	67,000	33,000	m ² - Stück
	22,500	20,100	21,775	27,470	21,440	27,060	m ² - kg
	40	48	36	30	44	14	Paket - Stück
	0,800	0,716	0,537	0,448	0,656	0,424	Paket - m ²
	18,000	14,400	11,700	12,300	14,080	11,480	Paket - kg
	48,000	51,582	41,910	32,239	47,283	30,545	Palette - m ²
	1.080,000	1.036,800	912,600	885,600	1.013,760	826,560	Palette - kg
	Alla	Alla	Alla	Alla	Alla	Alla	Produktnorm
	siehe unten						Trittsicherheit
	2						Belastung
		9027-2120	9027-2250	9027-2270	9027-2280	9027-2240	reinweiß
		Preisgr. A125 (m ²)	Preisgr. A315 (m ²)	Preisgr. A315 (m ²)	Preisgr. A315 (m ²)	Preisgr. A343 (m ²)	
		9026-2120	9026-2250	9026-2270	9026-2280	9026-2240	weiß
		Preisgr. A125 (m ²)	Preisgr. A315 (m ²)	Preisgr. A315 (m ²)	Preisgr. A315 (m ²)	Preisgr. A343 (m ²)	
		9022-2120	9022-2250	9022-2270	9022-2280	9022-2240	mittelgrau
		Preisgr. A125 (m ²)	Preisgr. A315 (m ²)	Preisgr. A315 (m ²)	Preisgr. A315 (m ²)	Preisgr. A343 (m ²)	
		9021-2120	9021-2250	9021-2270	9021-2280	9021-2240	dunkelgrau
		Preisgr. A125 (m ²)	Preisgr. A315 (m ²)	Preisgr. A315 (m ²)	Preisgr. A315 (m ²)	Preisgr. A343 (m ²)	
		9020-2120	9020-2250	9020-2270	9020-2280	9020-2240	olivgrün
		Preisgr. A125 (m ²)	Preisgr. A315 (m ²)	Preisgr. A315 (m ²)	Preisgr. A315 (m ²)	Preisgr. A343 (m ²)	
		9023-2120	9023-2250	9023-2270	9023-2280	9023-2240	goldgelb
		Preisgr. A125 (m ²)	Preisgr. A315 (m ²)	Preisgr. A315 (m ²)	Preisgr. A315 (m ²)	Preisgr. A343 (m ²)	
		9025-2120	9025-2250	9025-2270	9025-2280	9025-2240	geflammt
		Preisgr. A125 (m ²)	Preisgr. A315 (m ²)	Preisgr. A315 (m ²)	Preisgr. A315 (m ²)	Preisgr. A343 (m ²)	amber
		9024-2120	9024-2250	9024-2270	9024-2280	9024-2240	geflammt
		Preisgr. A125 (m ²)	Preisgr. A315 (m ²)	Preisgr. A315 (m ²)	Preisgr. A315 (m ²)	Preisgr. A343 (m ²)	blaugrün
		9030-2120	9030-2250	9030-2270	9030-2280	9030-2240	geflammt
		Preisgr. A125 (m ²)	Preisgr. A315 (m ²)	Preisgr. A315 (m ²)	Preisgr. A315 (m ²)	Preisgr. A343 (m ²)	jadegrün
		9031-2120	9031-2250	9031-2270	9031-2280	9031-2240	beryllrot
		Preisgr. A125 (m ²)	Preisgr. A315 (m ²)	Preisgr. A315 (m ²)	Preisgr. A315 (m ²)	Preisgr. A343 (m ²)	
		9032-2120	9032-2250	9032-2270	9032-2280	9032-2240	benitblau
		Preisgr. A125 (m ²)	Preisgr. A315 (m ²)	Preisgr. A315 (m ²)	Preisgr. A315 (m ²)	Preisgr. A343 (m ²)	
		9033-2120	9033-2250	9033-2270	9033-2280	9033-2240	hämatischwarz
		Preisgr. A125 (m ²)	Preisgr. A315 (m ²)	Preisgr. A315 (m ²)	Preisgr. A315 (m ²)	Preisgr. A343 (m ²)	
	951-2110	951-2120 ¹					tabak
	Preisgr. A101 (m ²)	Preisgr. A94 (m ²)					
	R11/A						goldocker
	851-2110						
	Preisgr. A101 (m ²)						goldcreme
	R11/A						
	854-2110						
	Preisgr. A101 (m ²)						goldgrau
	R11/A						
	855-2110						
	Preisgr. A101 (m ²)						goldschwarz
	R11/A						
	856-2110						
	Preisgr. A101 (m ²)						

¹ Auftragsfertigung: Rückgabe und/oder Stornierung bestellter Ware nicht möglich.

² Lieferung als Doppelplatten; müssen örtlich gebrochen werden.

³ Color Shade Variation

V1: reinweiß, weiß, mittelgrau, dunkelgrau, jadegrün, beryllrot, benitblau, hämatischwarz

V2: olivgrün geflammt, amber geflammt, goldcreme, goldgrau, goldschwarz

V3: goldgelb geflammt, blaugrün geflammt

V4: tabak, goldocker

⁴ Ausnahme: tabak: eben, seidenglänzend

Für die Serie Craft gilt:

Mindestabnahmemenge bei oben aufgeführten Farben: 250 m²

Mindestabnahmemenge bei Sonderfarben: 500 m²

Minderpreismengepreis auf Anfrage.

Eine Überproduktion von 10 % muss mit abgenommen werden.

Überglasierte Kante(n) bis max. 10 % der Auftragsmenge möglich.

Gesonderte Bestellung nötig.



Abdeckplatte^{1/2}

25 x 30 cm

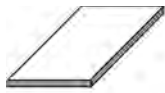

Schenkelplatten^{1/2}

12,5 x 25 cm



6,2 x 25 cm



Eckstücke^{1/2}



Tropfkante

Formatnummer	9220	4822	2521	2721	2720		
Nennmaß - cm/in	25 x 30 / 10 x 12	12,5 x 25 / 5 x 10	6,2 x 25 / 2 1/2 x 10				
Herstellmaß	240 x 300 x 20 mm	115/52 x 240 x 11 mm	52/52 x 240 x 11 mm	115/52 x 52 x 11 mm	52/52 x 52 x 11 mm		
Oberfläche	eben, glänzend	eben, glänzend	eben, glänzend	eben, glänzend	eben, glänzend		
m - Stück	4,000	4,000	4,000				
m/St. - kg	12,124/m	3,880/m	2,240/m	0,204/Stück	0,122/Stück		
Paket - Stück	7	8	16	15	40		
Paket - m	1,750	2,000	4,000				
Paket - kg	21,217	7,760	8,960	3,060	4,880		
Palette - m							
Palette - kg							
Produktnorm	Alla	Alla	Alla	Alla	Alla		
reinweiß	9027-9220 Preisgr. A471 (St.)	9027-4822 Preisgr. A458 (St.)	9027-2521 Preisgr. A458 (St.)	9027-2721 Preisgr. A428 (St.)	9027-2720 Preisgr. A428 (St.)		
weiß	9026-9220 Preisgr. A471 (St.)	9026-4822 Preisgr. A458 (St.)	9026-2521 Preisgr. A458 (St.)	9026-2721 Preisgr. A428 (St.)	9026-2720 Preisgr. A428 (St.)		
mittelgrau	9022-9220 Preisgr. A471 (St.)	9022-4822 Preisgr. A458 (St.)	9022-2521 Preisgr. A458 (St.)	9022-2721 Preisgr. A428 (St.)	9022-2720 Preisgr. A428 (St.)		
dunkelgrau	9021-9220 Preisgr. A471 (St.)	9021-4822 Preisgr. A458 (St.)	9021-2521 Preisgr. A458 (St.)	9021-2721 Preisgr. A428 (St.)	9021-2720 Preisgr. A428 (St.)		
olivgrün geflammt	9020-9220 Preisgr. A471 (St.)						
goldgelb geflammt	9023-9220 Preisgr. A471 (St.)						
amber geflammt	9025-9220 Preisgr. A471 (St.)						
blaugrün geflammt	9024-9220 Preisgr. A471 (St.)						
jadegrün	9030-9220 Preisgr. A471 (St.)	9030-4822 Preisgr. A458 (St.)	9030-2521 Preisgr. A458 (St.)	9030-2721 Preisgr. A428 (St.)	9030-2720 Preisgr. A428 (St.)		
beryllrot	9031-9220 Preisgr. A471 (St.)	9031-4822 Preisgr. A458 (St.)	9031-2521 Preisgr. A458 (St.)	9031-2721 Preisgr. A428 (St.)	9031-2720 Preisgr. A428 (St.)		
benitblau	9032-9220 Preisgr. A471 (St.)	9032-4822 Preisgr. A458 (St.)	9032-2521 Preisgr. A458 (St.)	9032-2721 Preisgr. A428 (St.)	9032-2720 Preisgr. A428 (St.)		
hämatitschwarz	9033-9220 Preisgr. A471 (St.)	9033-4822 Preisgr. A458 (St.)	9033-2521 Preisgr. A458 (St.)	9033-2721 Preisgr. A428 (St.)	9033-2720 Preisgr. A428 (St.)		



¹ Auftragsfertigung: Rückgabe und/oder Stornierung bestellter Ware nicht möglich. Mindestmenge auf Anfrage.

² Color Shade Variation
 V1: reinweiß, weiß, mittelgrau, dunkelgrau, jadegrün, beryllrot, benitblau, hämatitschwarz
 V2: olivgrün geflammt, amber geflammt
 V3: goldgelb geflammt, blaugrün geflammt

Projekt: Restaurant OCTAVE / Standort: Antwerpen, Belgien / Architekt: real.space agency Antwerpen, Belgien /
Serie: Craft / Foto: Marcel van der Burg, Amsterdam



Projekt: Wohnquartier Bellaria / Standort: Zürich-Wollishofen, Schweiz / Architekt: Michael Meier und Marius Hug Architekten AG, Zürich, Schweiz – Michael Meier und Marius Hug Architekten AG, Zürich, Schweiz / Serie: Craft Extended / Foto: Adriano Faragulo

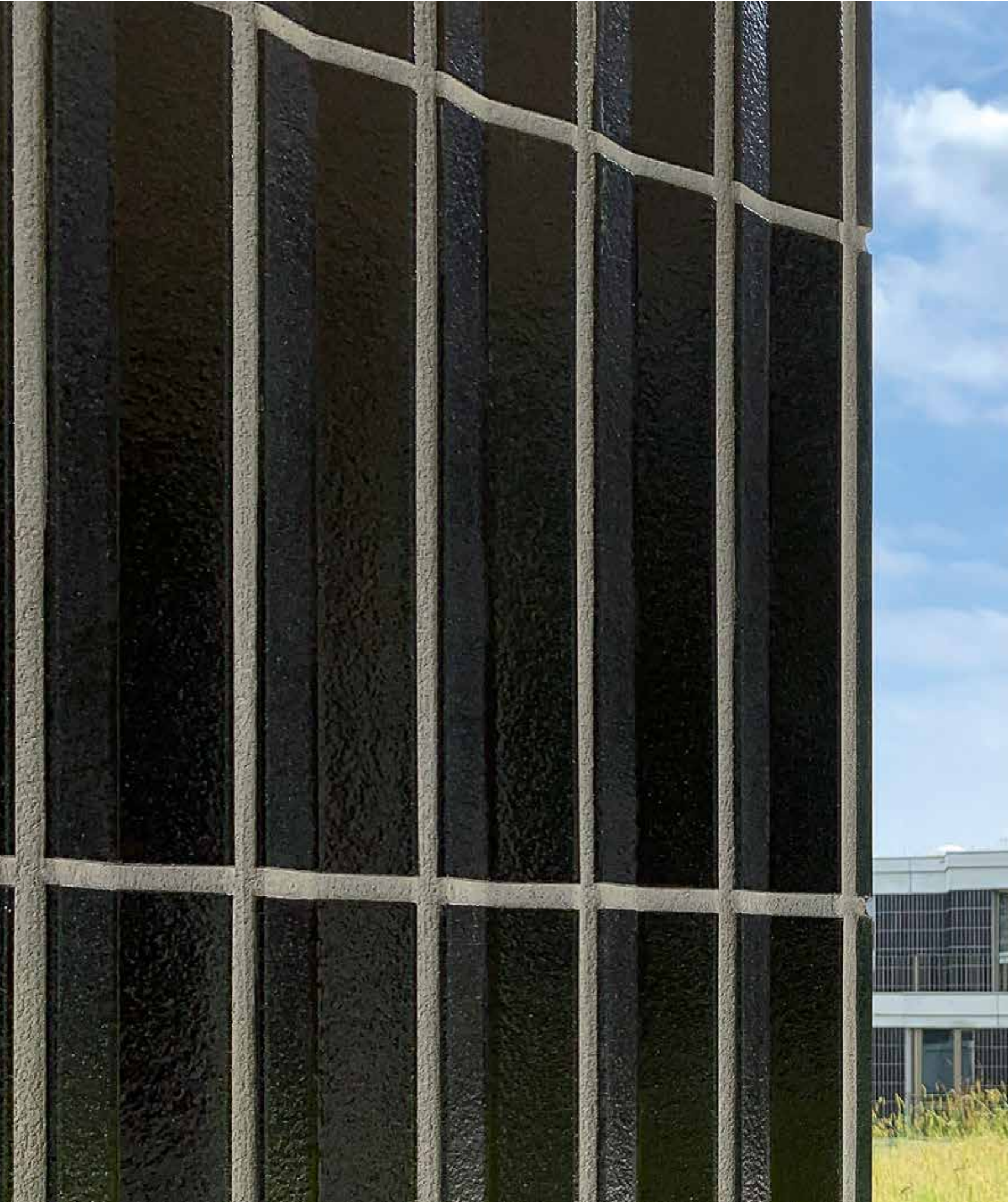



Unifarben



kalkweiß



naturweiß



perlgrau



naturgrau



resedagrün



karmesinrot



kobaltblau



tiefschwarz

Geflammte Farben



schilfgrün geflammt



rotbraun geflammt



petrolblau geflammt

*Langriemchen 6,2 x 50 cm**Langriemchen Spitzprofil symmetrisch 6,2 x 50 cm**Abdeckplatte Tropfkante, 31 x 30 cm*

6,2 x 50 cm^{1/2}



6,2 x 50 cm^{1/2}



31 x 30 cm^{1/2}



	Riemchen	Spitzprofil sym.	Abdeckplatte Tropfkante	
	2320	2290	9215	Formatnummer
	6,2 x 50 / 2 1/2 x 20	6,2 x 50 / 2 1/2 x 20	31 x 30 / 12 13/64 x 12	Nennmaß - cm/in
	52 x 490 x 11 mm	52 x 490 x 18/11 mm	300 x 300 x 15 mm	Herstellmaß
	eben, glänzend	eben, glänzend	eben, glänzend	Oberfläche
	32,258/m ²	32,258/m ²	3,226/m	m ² /m - Stück
	18,710/m ²	27,097 m ²	8,904/m	m ² /m - kg
	22	13	8	Paket - Stück
	0,682 m ²	0,403 m ²	2,480 m	Paket - m ² /m
	12,760	10,920	22,080	Paket - kg
	40,920	24,180		Palette - m ²
	765,600	655,200		Palette - kg
	Alla	Alla	Alla	Produktnorm
	19027-2320	19027-2290	19027-9215	kalkweiß
	Preisgr. A184 (m ²)	Preisgr. A351 (m ²)	Preisgr. A471 (St.)	
	19026-2320	19026-2290	19026-9215	naturweiß
	Preisgr. A184 (m ²)	Preisgr. A351 (m ²)	Preisgr. A471 (St.)	
	19022-2320	19022-2290	19022-9215	perlgrau
	Preisgr. A184 (m ²)	Preisgr. A351 (m ²)	Preisgr. A471 (St.)	
	19021-2320	19021-2290	19021-9215	naturgrau
	Preisgr. A184 (m ²)	Preisgr. A351 (m ²)	Preisgr. A471 (St.)	
	19020-2320	19020-2290	19020-9215	schilfgrün
	Preisgr. A184 (m ²)	Preisgr. A351 (m ²)	Preisgr. A471 (St.)	geflammt
	19025-2320	19025-2290	19025-9215	rotbraun
	Preisgr. A184 (m ²)	Preisgr. A351 (m ²)	Preisgr. A471 (St.)	geflammt
	19024-2320	19024-2290	19024-9215	petrolblau
	Preisgr. A184 (m ²)	Preisgr. A351 (m ²)	Preisgr. A471 (St.)	geflammt
	19030-2320	19030-2290	19030-9215	resedagrün
	Preisgr. A184 (m ²)	Preisgr. A351 (m ²)	Preisgr. A471 (St.)	
	19031-2320	19031-2290	19031-9215	karmesinrot
	Preisgr. A184 (m ²)	Preisgr. A351 (m ²)	Preisgr. A471 (St.)	
	19032-2320	19032-2290	19032-9215	kobaltblau
	Preisgr. A184 (m ²)	Preisgr. A351 (m ²)	Preisgr. A471 (St.)	
	19033-2320	19033-2290	19033-9215	tiefschwarz
	Preisgr. A184 (m ²)	Preisgr. A351 (m ²)	Preisgr. A471 (St.)	

¹  Auftragsfertigung: Rückgabe und/oder Stornierung bestellter Ware nicht möglich.

² Color Shade Variation

V1: kalkweiß, naturweiß, perlgrau, naturgrau, resedagrün, karmesinrot, kobaltblau, tiefschwarz

V2: schilfgrün geflammt

V3: rotbraun geflammt, petrolblau geflammt

Für die Serie Craft Extended gilt:

Mindestabnahmemenge bei oben aufgeführten Farben: 250 m²

Mindestabnahmemenge bei Sonderfarben: 500 m²

Minderpreisenpreise auf Anfrage.

Eine Überproduktion von 10 % muss mit abgenommen werden.

Überglaste Kante(n) mit 25 % der Auftragsmenge möglich, gesonderte Bestellung nötig.





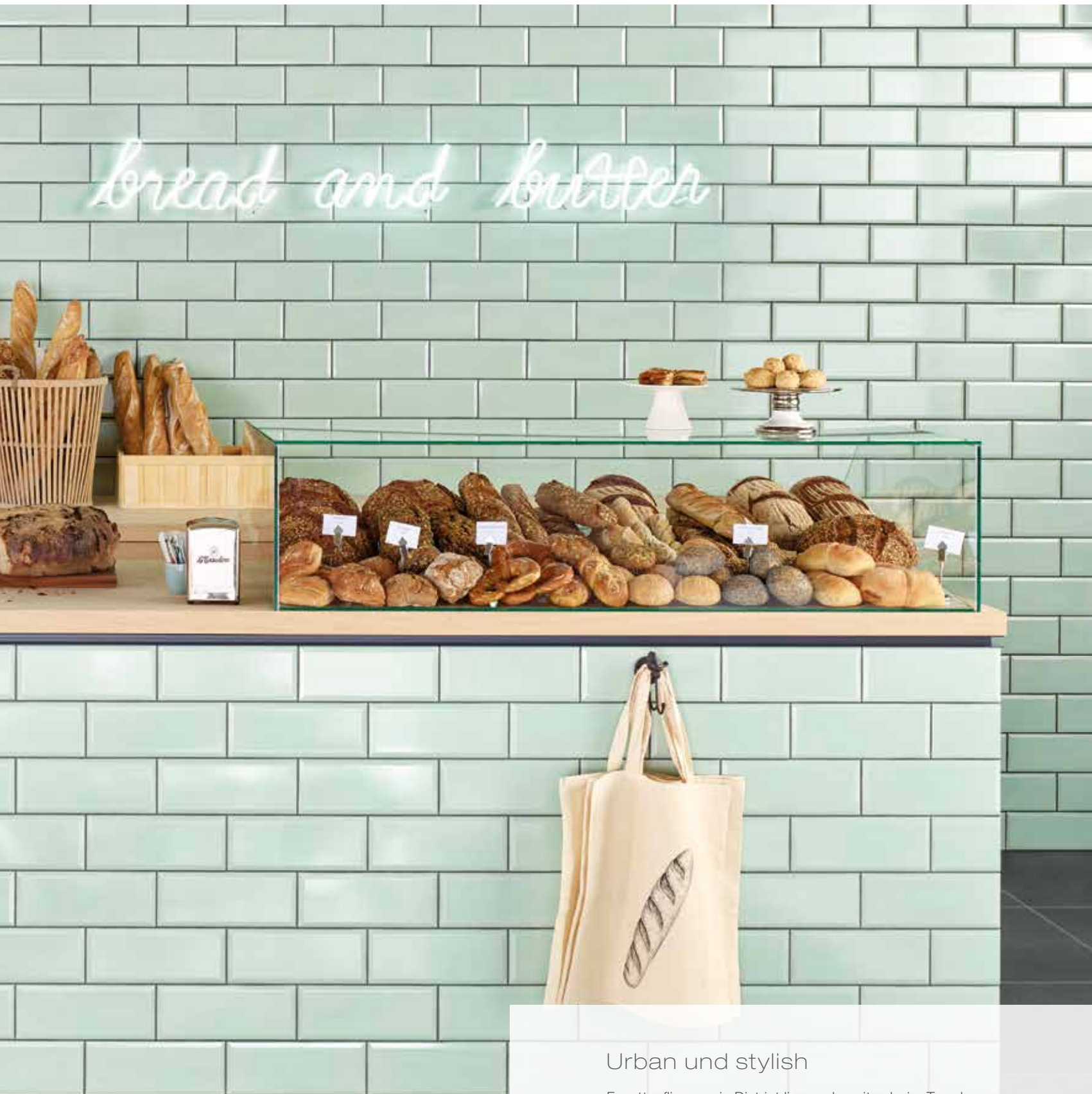

Urban und stylish

Facettenfliesen wie District liegen derzeit sehr im Trend. Ob in Küche, Bad, Läden oder Wohnbereichen – sie sorgen für edlen, minimalistischen oder stylischen Look, je nach Farbe und Anwendungsbereich. Mit District stehen acht Trendfarben zur Auswahl. Alle sind in den Formaten 5 x 10 cm und 10 x 25 cm erhältlich. Durch die rückseitige thermoplastische Verklebung beim Format 5 x 10 cm sind diese zudem besonders einfach als Matten zu verlegen.



Wandfliese 5 x 10 cm
almond beige



Wandfliese 5 x 10 cm
white



Wandfliese 10 x 25 cm
almond beige



Wandfliese 10 x 25 cm
white

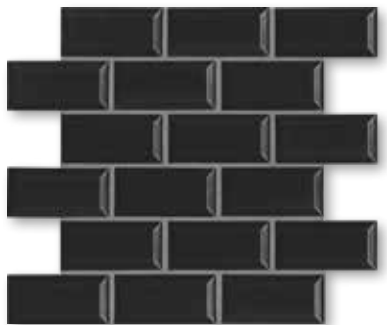

Wandfliese 5 x 10 cm
pitch black



Wandfliese 5 x 10 cm
ash grey



Wandfliese 10 x 25 cm
pitch black



Wandfliese 10 x 25 cm
ash grey



Wandfliese 5 x 10 cm
miami mint

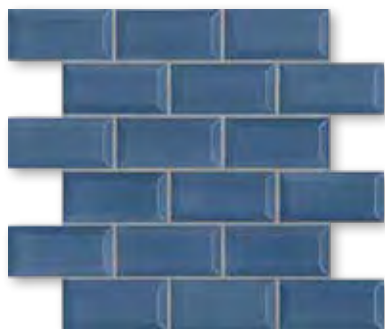

Wandfliese 5 x 10 cm
denim blue

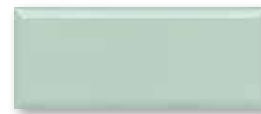

Wandfliese 10 x 25 cm
miami mint

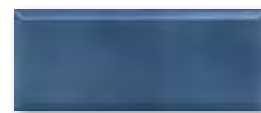

Wandfliese 10 x 25 cm
denim blue



Wandfliese 5 x 10 cm
racing green



Wandfliese 5 x 10 cm
burgundy red



Wandfliese 10 x 25 cm
racing green



Wandfliese 10 x 25 cm
burgundy red

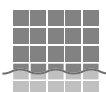

Rückseitig thermoplastisch verklebte Mosaik von AGROB BUCHTAL sind nicht nur im Trockenbereich, sondern auch bedenkenlos im Unterwasserbereich (z. B. Schwimmbecken/Whirlpool) sowie im dauernassbelasteten Bereich (z. B. Beckenumgänge/Duschen) einsetzbar.

Wandfliesen

5 x 10 cm

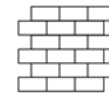

10 x 25 cm



Facette
Mosaik, rückseitig
thermoplastisch verklebt
Bogen: 316 x 316 mm

Facette



				5 x 10 / 2 x 4	10 x 25 / 4 x 10	Nennmaß - cm/in
				50 x 100 x 6,5 mm	97 x 247 x 6,5 mm	Herstellmaß
				eben, glänzend	eben, glänzend	Oberfläche
				10 Bögen	40,000	m ² - Stück
				16,570	19,000	m ² - kg
				8 Bögen	20	Paket - Stück
				0,800	0,500	Paket - m ²
				13,256	9,500	Paket - kg
				48,000	64,000	Palette - m ²
				795,360	1.216,000	Palette - kg
				Bib	Bib	Produktnorm
				45550H	45600H	almond beige
				Preisgr. A139 (m ²)	Preisgr. A139 (m ²)	
				45551H	45601H	white
				Preisgr. A139 (m ²)	Preisgr. A139 (m ²)	
				45552H	45602H	pitch black
				Preisgr. A139 (m ²)	Preisgr. A139 (m ²)	
				45553H	45603H	ash grey
				Preisgr. A139 (m ²)	Preisgr. A139 (m ²)	
				45554H	45604H	miami mint
				Preisgr. A139 (m ²)	Preisgr. A139 (m ²)	
				45555H	45605H	denim blue
				Preisgr. A139 (m ²)	Preisgr. A139 (m ²)	
				45556H	45606H	racing green
				Preisgr. A139 (m ²)	Preisgr. A139 (m ²)	
				45557H	45607H	burgundy red
				Preisgr. A139 (m ²)	Preisgr. A139 (m ²)	

Nur für die Verlegung an der Wand geeignet.



Projekt: Lehr- und Versuchsanstalt für Wein- und Obstbau / Standort: Weinsberg, Deutschland/ Architekt: Staatl. Hochbauamt / Serie: Ferrum / Foto: Andreas Freytag





Leitfähige Bodenbeläge

Diese beiden speziellen Problemlösungen – einmal als Spaltplatte (Eladuct), einmal als keramische Großplatte im Format 60 x 60 cm (ELA 10.6) – eignen sich zur Anwendung in jenen Bereichen, die wegen elektrostatischer Aufladung einen leitfähigen Bodenbelag aufweisen müssen oder für die ein solcher empfohlen wird. Dabei sind besondere Verlegevorschriften zu beachten. Wir beraten Sie gerne detailliert und auf den Einzelfall abgestimmt.

ELADUCT

Elektrostatisch ableitende unglasierte Spaltplatten



3555
rotbraun unglasiert

Schnitt

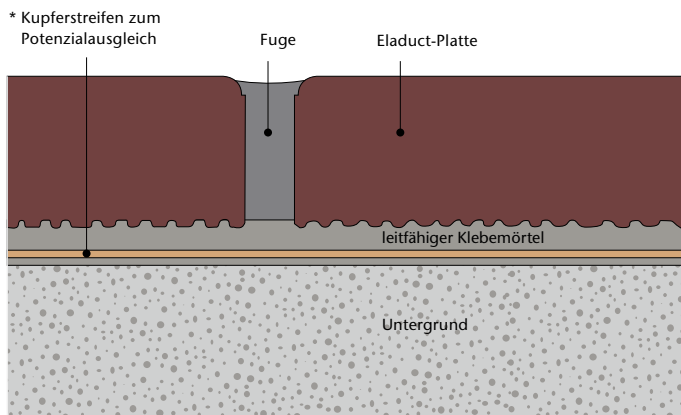

* Anzahl und Anordnung je nach technischen Erfordernissen. Der Anschluss ist durch eine Elektrofachkraft gemäß den entsprechenden Richtlinien vorzunehmen.

Bei Eladuct erfolgt die Ableitung durch den Plattenkörper. Durchgangswiderstand nach Verfahren A gemäß DIN EN 1081: 10^9 Ohm.

KERAION ELA 10.6



2401 RH - IV
grau glasiert
(RH = rutschhemmende Version)

Schnitt

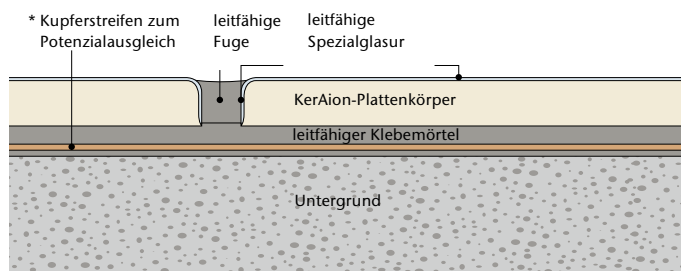

* Anzahl und Anordnung je nach technischen Erfordernissen. Der Anschluss ist durch eine Elektrofachkraft gemäß den entsprechenden Richtlinien vorzunehmen.

Bei ELA 10.6 erfolgt die Ableitung über die vier überglasierten Plattenkanten. Oberflächenwiderstand nach Verfahren C gemäß DIN EN 1081: 10^6 Ohm. Ableitwiderstand R_A gemäß DIN EN 1081: 10^6 Ohm.



Leitfähige Bodenbeläge

Diese beiden speziellen Problemlösungen – einmal als Spaltplatte (Eladuct), einmal als keramische Großplatte im Format 60 x 60 cm (ELA 10.6) – eignen sich zur Anwendung in jenen Bereichen, die wegen elektrostatischer Aufladung einen leitfähigen Bodenbelag aufweisen müssen oder für die ein solcher empfohlen wird. Dabei sind besondere Verlegevorschriften zu beachten. Wir beraten Sie gerne detailliert und auf den Einzelfall abgestimmt.

Eladuct

ist insbesondere prädestiniert für Bereiche, wo elektrostatische Ableitfähigkeit und die Vorteile einer unglasierten Oberfläche (hohe mechanisch-chemische Belastbarkeit) erwünscht sind.

Beispiele: Tief- und Flexodruckbereiche, Laboratorien, Räume für Lackherstellung, -verarbeitung und Umfüllung, Munitionsdepots, chemische Produktionsbetriebe etc.



KerAion ELA 10.6

empfehlenswert für jene Bereiche, wo elektrostatische Ableitfähigkeit erwünscht ist und Wert gelegt wird auf die Vorteile einer glasierten Oberfläche (z. B. besonders reinigungsfreundlich) und eine großzügige, repräsentative Optik. Beispiele: Büroräume, Produktionsräume für elektronische Geräte, physikalische Mess- und Arbeitsräume, Labors, Räume für Microchip- und Computerverfertigung, medizinische Bereiche (z. B. OP-Räume), Fernmeldewerkstätten, Elektronik-Verkaufsräume etc.

Bodenplatten Sockelsystem

25 x 12,5 cm



25 x 8,9 cm



			1110	4000	4003	4004	
			25 x 12,5 / 10 x 5	25 x 8,9 / 10 x 3 1/2			Formatnummer
			240 x 115 x 20	240 x 79/9 x 11	(2x) 131 x 79/9 x 11	(2x) 115 x 79/9 x 11	Nennmaß - cm/in
			eben, matt	eben, matt	eben, matt	eben, matt	Herstellmaß mm
			33,000/m ²	4,000/m			Oberfläche
			53,955/m ²	2,200/m	0,590/Paar	0,550/Paar	m ² /m - Stück
			13 Stück	16 Stück	8 Paar	8 Paar	m ² /m/Paar - kg
			0,394 m ²	4,000 m			Paket - St./Paar
			21,255	8,800	4,720	4,400	Paket - m ² /m
			28,360				Paket - kg
			1.530,360				Palette - m ²
			Alb	Alb	Alb	Alb	Palette - kg
			R10				Produktnorm
			4				Trittsicherheit
			3555-1110	3555-4000	3555-4003	3555-4004	Belastung
			Preisgr. A330 (m ²)	Preisgr. A467 (St.)	Preisgr. A528 (Paar)	Preisgr. A528 (Paar)	rotbraun ungl.

Bei Eladuct erfolgt die Ableitung durch den Plattenkörper.

Durchgangswiderstand nach Verfahren A gemäß DIN EN 1081: 10⁸ Ohm.

Die 355s definiert sich über den Durchgangswiderstand und nicht über die Farbstellung. Farbabweichungen müssen akzeptiert werden und sind kein Beanstandungsgrund.



KERAION ELA 10.6

Bodenplatten Sockelsystem

(elektrostatisch ableitend)

(nicht elektrostatisch ableitend)

60 x 60 cm



30 x 8,7 cm

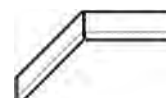

			K100	37040	37043	37044	37042	
			60 x 60 / 24 x 24	30 x 8,7 / 12 x 3 1/2				Formatnummer
			592 x 592 x 8	292 x 79/12 x 8	280/292 x 79/12 x 8	280/292 x 79/12 x 8	(2x) 292 x 79/12 x 8	Nennmaß - cm/in
			eben, matt	eben, matt	eben, matt	eben, matt	eben, matt	Herstellmaß mm
			2,860/m ²	3,333/m				Oberfläche
			18,533/m ²	1,700/m	0,550/Stück	0,550/Stück	1,100/Paar	m ² /m - Stück
			4 Stück	32 Stück	32 Stück	32 Stück	16 Paar	m ² /m/St./Paar - kg
			1,399 m ²	9,601 m				Paket - St./Paar
			25,920	16,320	17,600	17,600	17,600	Paket - m ² /m
			41,958					Paket - kg
			777,600					Palette - m ²
			Alb	Alb	Alb	Alb	Alb	Palette - kg
			R9					Produktnorm
			2					Trittsicherheit
			2401RH-K100-21					Belastung
			Preisgr. A330 (m ²)	590-37040-21	590-37043-21	590-37044-21	590-37042-21	4
				Preisgr. A445 (St.)	Preisgr. A458 (St.)	Preisgr. A458 (St.)	Preisgr. A489 (Paar)	grau glasiert
								grau glasiert

Bei KerAion ELA 10.6 erfolgt die Ableitung über die vier überglasierten Plattenkanten.

Oberflächenwiderstand nach Verfahren C gemäß DIN EN 1081: 10⁶ Ohm.



Studioaufnahme / Architektin: Sylvia Leydecker / Serie: Emotion / Foto: Jochen Stüber





Modular und zeitlos

Mit aufeinander abgestimmten Farben und Oberflächen, rutschhemmenden Fliesen von R9 bis R12V4 und Formaten von 20 x 20 bis 60 x 60 cm bieten die Fliesen der Serie Emotion Architekten viel Freiraum. Emotion sorgt vor allem dort für eine gute Gestaltung, wo es um den Übergang zwischen Bereichen mit unterschiedlichen Anforderungen an die Rutschhemmung geht. Front cooking im Blickkontakt zu den Restaurantgästen wird dadurch ebenso möglich wie das reibungslose und ästhetisch gelungene Nebeneinander von Werkstatt und Showroom in einem Autohaus.



Oberflächen: Bodenfliesen



basalt

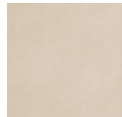

hellbeige

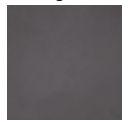

tiefanthrazit

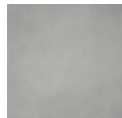

mittelgrau



Bodenfliese 20 x 20 cm
Feinsteinzeug, eben, R10/A+B



Bodenfliese 30 x 30 cm
Feinsteinzeug, strukturiert, R10/A



Bodenfliese 30 x 30 cm
Feinsteinzeug, reliefiert, R11/B



Bodenfliese 30 x 60 cm
Feinsteinzeug, eben, R9
Feinsteinzeug, strukturiert, R10/A
Feinsteinzeug, reliefiert, R11/B



Bodenfliese 60 x 60 cm
Feinsteinzeug, eben, R9
Feinsteinzeug, strukturiert, R10/A



Kehlsockel 10 x 20 cm**
Feinsteinzeug, eben, R10/A



Kehlsockel 10 x 30 cm**
Feinsteinzeug, eben, R10/A



Innenecke zu Kehlsockel**
Feinsteinzeug, eben



Außenecke zu Kehlsockel**
Feinsteinzeug, eben

** Farbabweichung, da Feinkornoptik.



Treppenfliese 30 x 60 cm (rilliert)
Feinsteinzeug, eben, R9
Feinsteinzeug, strukturiert, R10/A



Sockel, gerundet 7 x 60 cm
Feinsteinzeug, eben
Feinsteinzeug, strukturiert

Keramische Rinnenabdeckung*
Ecklösung 30 x 30 cm

Keramische Rinnenabdeckung*
25 x 50 cm



*Details siehe Kapitel Pool + Spa; Keramische Rinnenabdeckung 2.0,
Seite 438, (auftragsbezogene Fertigung).



basalt



hellbeige



tiefanthrazit



mittelgrau

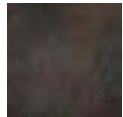

bronze

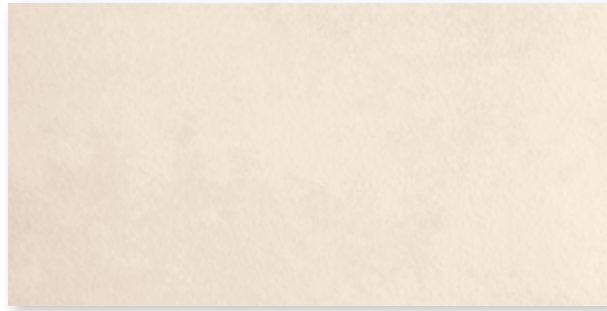

Wandfliese 30 x 60 cm
Steingut, hellbeige



Wandfliese 30 x 60 cm
Steingut, mittelgrau

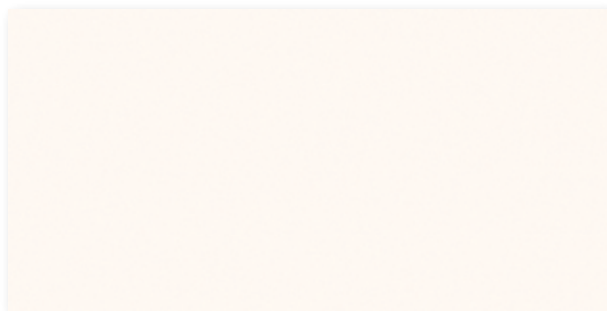

Wandfliese 30 x 60 cm
Steingut, sandweiß

Bordüren & Dekore



*Bordüre Shades 15 x 60 cm
2er-Set, bronze-gold, eben*



*Dekorfliese Shades 30 x 60 cm
bronze-gold, eben*



*Bordüre Rocks 10 x 60 cm
2er-Set, bronze, reliefiert*

Wandfliesen³ Bordüren und Dekore

30 x 60 cm



15 x 60 cm^{1/2/4}



30 x 60 cm^{1/2/4}



10 x 60 cm^{1/2/4}



Bordüre Shades
Feinsteinzeug
2er-Set

Shades Dekorfliese
Feinsteinzeug

Bordüre Rocks
Feinsteinzeug
2er-Set

Nennmaß - cm/in	30 x 60 / 12 x 24	15 x 60 / 6 x 24	30 x 60 / 12 x 24	10 x 60 / 4 x 24			
Herstellmaß	297 x 597 x 9 mm	147 x 597 x 10,5 mm	297 x 597 x 10,5 mm	97 x 597 x 9 mm			
Oberfläche	eben, seidenmatt	eben, matt	eben, matt	reliefiert, poliert			
m ² /m - Stück	5,556/m ²	1,667/m	1,667/m	1,667/m			
m ² /m - kg	14,946/m ²	3,484/m	6,968/m	2,367/m			
Paket - Stück	9	2	2	2			
Paket - m ² /m	1,620 m ²	1,200 m	1,200 m	1,200 m			
Paket - kg	24,210	4,180	8,360	2,840			
Palette - m ²	77,754						
Palette - kg	1.162,083						
Produktnorm	BIII	Bla	Bla	Bla			
sandweiß	281757H Preisgr. A67 (m ²)						
hellbeige	281759H Preisgr. A67 (m ²)						
mittelgrau	281758H Preisgr. A67 (m ²)						
bronze-gold		433715 Preisgr. 2 x A506 (Set)	433716 Preisgr. A556 (St.)				
bronze				433725 Preisgr. 2 x A593 (Set)			

¹ ohne Hytect-Veredelung

² nur für die Verlegung an der Wand geeignet

³ Color Shade Variation: V1

⁴ rektifiziert



Hinweis: Abgabe der Dekorationselemente ausschließlich in vollen Kartons.

Bodenfliesen¹

20 x 20 cm



30 x 30 cm



30 x 30 cm



Nennmaß - cm/in	20 x 20 / 8 x 8	30 x 30 / 12 x 12	30 x 30 / 12 x 12			
Herstellmaß	197 x 197 x 10,5 mm	297 x 297 x 10,5 mm	297 x 297 x 10,5 mm			
Oberfläche	eben, matt	strukturiert, matt	reliefiert, matt			
m ² - Stück	25,000	11,110	11,110			
m ² - kg	22,900	23,142	23,142			
Paket - Stück	21	11	11			
Paket - m ²	0,840	0,990	0,990			
Paket - kg	19,236	22,913	22,913			
Palette - m ²	50,400	47,525	47,525			
Palette - kg	1.154,160	1.099,824	1.099,824			
Produktnorm	Bla	Bla	Bla			
Trittsicherheit	R10/A+B	R10/A	R11/B			
Belastung	2 - 3	2 - 3	2 - 3			
tiefanthrazit	432016 Preisgr. A113 (m ²)	433730 Preisgr. A81 (m ²)	433733 Preisgr. A94 (m ²)			
hellbeige	432017 Preisgr. A113 (m ²)	433732 Preisgr. A81 (m ²)	433735 Preisgr. A94 (m ²)			
mittelgrau	432018 Preisgr. A113 (m ²)	433731 Preisgr. A81 (m ²)	433734 Preisgr. A94 (m ²)			
basalt	432019 Preisgr. A113 (m ²)	433440 Preisgr. A81 (m ²)	433442 Preisgr. A94 (m ²)			

¹ Color Shade Variation: V2



Bodenfliesen²

30 x 60 cm¹



30 x 60 cm¹



30 x 60 cm¹



60 x 60 cm¹



60 x 60 cm¹



protected

	30 x 60 / 12 x 24	30 x 60 / 12 x 24	30 x 60 / 12 x 24	60 x 60 / 24 x 24	60 x 60 / 24 x 24	Nennmaß - cm/in
	297 x 597 x 10,5 mm	297 x 597 x 10,5 mm	297 x 597 x 10,5 mm	597 x 597 x 10,5 mm	597 x 597 x 10,5 mm	Herstellmaß
	eben, matt	strukturiert, matt	reliefiert, matt	eben, matt	strukturiert, matt	Oberfläche
	5,556	5,556	5,556	2,778	2,778	m ² - Stück
	23,224	23,224	23,224	23,769	23,769	m ² - kg
	6	6	6	3	3	Paket - Stück
	1,080	1,080	1,080	1,080	1,080	Paket - m ²
	25,080	25,080	25,080	25,668	25,668	Paket - kg
	43,197	43,197	43,197	38,877	38,877	Palette - m ²
	1.003,200	1.003,200	1.003,200	924,048	924,048	Palette - kg
	Bla	Bla	Bla	Bla	Bla	Produktnorm
	R9	R10/A	R11/B	R9	R10/A	Trittsicherheit
	2 - 3	2 - 3	2 - 3	2 - 3	2 - 3	Belastung
	433402	433406	433410	433660	433664	tiefanthrazit
	Preisgr. A101 (m ²)	Preisgr. A101 (m ²)	Preisgr. A139 (m ²)	Preisgr. A150 (m ²)	Preisgr. A150 (m ²)	
	433404	433408	433412	433662	433666	hellbeige
	Preisgr. A101 (m ²)	Preisgr. A101 (m ²)	Preisgr. A139 (m ²)	Preisgr. A150 (m ²)	Preisgr. A150 (m ²)	
	433403	433407	433411	433661	433665	mittelgrau
	Preisgr. A101 (m ²)	Preisgr. A101 (m ²)	Preisgr. A139 (m ²)	Preisgr. A150 (m ²)	Preisgr. A150 (m ²)	
	433430	433432	433434	433436	433438	basalt
	Preisgr. A101 (m ²)	Preisgr. A101 (m ²)	Preisgr. A139 (m ²)	Preisgr. A150 (m ²)	Preisgr. A150 (m ²)	



² Color Shade Variation: V2



Treppenfliesen^{1/2/3}

30 x 60 cm



30 x 60 cm



7 x 60 cm



7 x 60 cm



protected

	30 x 60 / 12 x 24	30 x 60 / 12 x 24	7 x 60 / 2 13/16 x 24	7 x 60 / 2 13/16 x 24	Nennmaß - cm/in
	297 x 597 x 10,5 mm	297 x 597 x 10,5 mm	70 x 597 x 10,5 mm	70 x 597 x 10,5 mm	Herstellmaß
	eben, matt	strukturiert, matt	eben, matt	strukturiert, matt	Oberfläche
	1,667	1,667	1,667	1,667	m ² - Stück
	6,968	6,968	1,717	1,717	m ² - kg
	6	6	22	22	Paket - Stück
	3,599	3,599	13,197	13,197	Paket - m ²
	25,080	25,080	22,660	22,660	Paket - kg
	Bla	Bla	Bla	Bla	Palette - m ²
	R9	R10/A			Palette - kg
	2 - 3	2 - 3			Produktnorm
	433850	433854	433802	433806	Trittsicherheit
	Preisgr. A475 (St.)	Preisgr. A475 (St.)	Preisgr. A434 (St.)	Preisgr. A434 (St.)	Belastung
	433852	433856	433804	433808	tiefanthrazit
	Preisgr. A475 (St.)	Preisgr. A475 (St.)	Preisgr. A434 (St.)	Preisgr. A434 (St.)	
	433851	433855	433803	433807	hellbeige
	Preisgr. A475 (St.)	Preisgr. A475 (St.)	Preisgr. A434 (St.)	Preisgr. A434 (St.)	
	433817	433819	433821	433823	mittelgrau
	Preisgr. A475 (St.)	Preisgr. A475 (St.)	Preisgr. A434 (St.)	Preisgr. A434 (St.)	
					basalt



² Auftragsfertigung: Rückgabe und/oder Stornierung bestellter Ware nicht möglich.



³ Color Shade Variation: V2

Kehlsockel^{1/3/4}

Innenecke zu Kehlsockel^{1/2/3/4}

Außenecke zu Kehlsockel^{1/2/3/4}

Hohlkehlssockel^{5/6/7/8/9}

Innenecke^{5/6/7/8/9}



protected

10 x 20 cm



10 x 30 cm



	Feinkorn	Feinkorn	Feinkorn	Feinkorn		
Nennmaß - cm/in	10 x 20 / 4 x 8	10 x 30 / 4 x 12			15 x 60 / 6 x 24	15 x 15 / 6 x 6
Herstellmaß	102 x 197 x 9 mm	102 x 297 x 10,5 mm	102 x 35 x 9 mm	102 x 35 x 9 mm	158 x 597 x 9 mm	158 x 158 x 10,5 mm
Oberfläche	eben, matt	eben, matt	eben, matt	eben, matt	strukturiert, matt	strukturiert, matt
m - Stück	5,000	3,333			1,667	
m - kg	2,000	1,999	0,080/Stück	0,080/Stück	4,334	
Paket - Stück	20	16	18	12	4	4
Paket - m	4,000	4,800			2,399	
Paket - kg	8,000	9,600			10,400	6,000
Palette - m ²						
Palette - kg						
Produktnorm	Bla	Bla	Bla	Bla	Bla	Bla
Trittsicherheit	R10/A	R10/A			R10/A	R10/A
	432027	432033	432039	432045		
tiefanthrazit	Preisgr. A419 (St.)	Preisgr. A425 (St.)	Preisgr. A418 (St.)	Preisgr. A418 (St.)		
	432029	432035	432041	432047	432805-HKS	432805-IE
hellbeige	Preisgr. A419 (St.)	Preisgr. A425 (St.)	Preisgr. A418 (St.)	Preisgr. A418 (St.)	Preisgr. A573 (St.)	Preisgr. A601 (St.)
	432028	432034	432040	432046		
mittelgrau	Preisgr. A419 (St.)	Preisgr. A425 (St.)	Preisgr. A418 (St.)	Preisgr. A418 (St.)		
	432030	432036	432042	432048		
basalt	Preisgr. A419 (St.)	Preisgr. A425 (St.)	Preisgr. A418 (St.)	Preisgr. A418 (St.)		



¹ Details siehe S. 483 ff

² passend zu Kehlsockel 10 x 20 cm / 10 x 30 cm

³ Achtung: Farbabweichung zum Restsortiment Emotion, da Feinkornoptik

⁴ Color Shade Variation: V1

⁵ Mindestmenge 50 Stück

⁶ Auf Anfrage auch in anderen Farben erhältlich

⁷ rektifiziert

⁸ Auftragsfertigung: Rückgabe und/oder Stormierung bestellter Ware nicht möglich.

⁹ Detailzeichnungen Hohlkehlssockel und Innenecke siehe S. 484

Studioaufnahme / Architektin: Iris Andernach / Serie: Emotion / Foto: Jochen Stüber



Projekt: KUBEZ (Kultur- und Begegnungszentrum) / Standort: Dietach, Deutschland / Architekt: Team M Architekten ZT GesmbH /
Serien: Emotion Grip / Foto: Roland Reuter, Absam







R10/A R11/B R11V4 R12 R12V4 R12V8 R13 R13V10



Oberflächen: Bodenfliesen

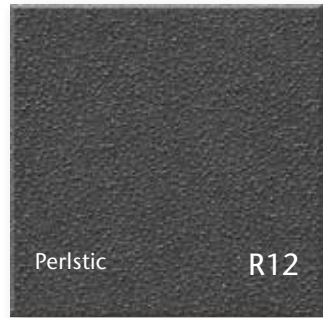
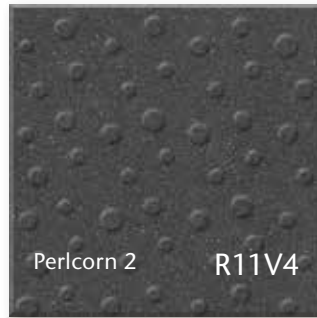
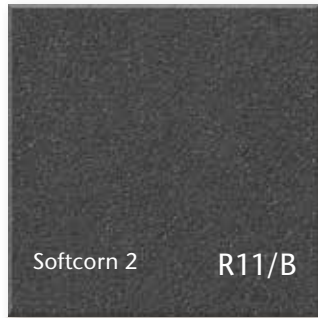
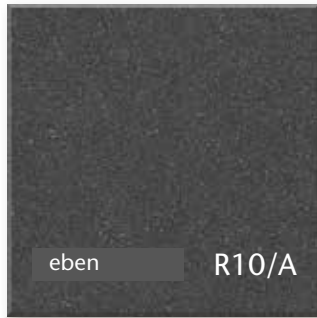

basalt

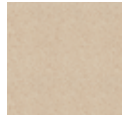

hellbeige



tiefanthrazit



mittelgrau



Bodenfliese 20 x 20 cm
 Feinsteinzeug, eben, R10/A
 Feinsteinzeug, Softcorn 2, R11/B
 Feinsteinzeug, Perlcorn 2, R11V4
 Feinsteinzeug, Perlstic, R12
 Feinsteinzeug, Carostic, R12V4
 Feinsteinzeug, Picstic, R12V8, überstark
 Feinsteinzeug, Geraut, R13, überstark
 Feinsteinzeug, Kobicorn, R13V10, überstark



Bodenfliese 30 x 30 cm
 Feinsteinzeug, eben, R10/A



Treppenfliese 30 x 30 cm (rilliert)
 Feinsteinzeug, eben, R10/A

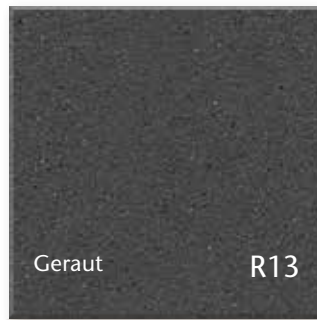
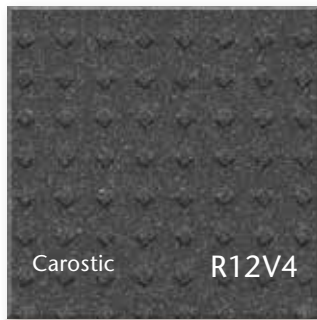

*Sockel mit Fase 10 x 20 cm
Feinsteinzeug, eben*



*Kehls sockel 10 x 20 cm
Feinsteinzeug, eben, R10/A*



*Kehls sockel 10 x 30 cm
Feinsteinzeug, eben, R10/A*



*Innenecke zu Kehls sockel
Feinsteinzeug, eben*



*Außenecke zu Kehls sockel
Feinsteinzeug, eben*



gelb



schwarz



*Sicherheitsdreiecke, überstark 27,8 x 20 cm
Feinsteinzeug, gekörnt, vergütet, R11*



Verlegemuster

Wand-/Bodenfliesen

20 x 20 cm 20 x 20 cm 20 x 20 cm 20 x 20 cm 20 x 20 cm



protected



	<i>Eben</i>	<i>Softcorn 2</i>	<i>Perlicorn 2</i>	<i>Perlstic</i>	<i>Carostic</i>		
Nennmaß - cm/in	20 x 20 / 8 x 8	20 x 20 / 8 x 8	20 x 20 / 8 x 8	20 x 20 / 8 x 8	20 x 20 / 8 x 8		
Herstellmaß	197 x 197 x 10,5 mm	197 x 197 x 10,5 mm	197 x 197 x 10,5 mm	197 x 197 x 10,5 mm	197 x 197 x 10,5 mm		
Oberfläche	eben, matt	strukturiert, matt	gekörnt, matt	gekörnt, matt	profiliert, matt		
m ² - Stück	25,000	25,000	25,000	25,000	25,000		
m ² - kg	22,900	22,900	22,900	22,900	22,900		
Paket - Stück	21	21	21	21	21		
Paket - m ²	0,840	0,840	0,840	0,840	0,840		
Paket - kg	19,236	19,236	19,236	19,236	19,236		
Palette - m ²	50,400	50,400	50,400	50,400	50,400		
Palette - kg	1.154,160	1.154,160	1.154,160	1.154,160	1.154,160		
Produktnorm	Bla	Bla	Bla	Bla	Bla		
Trittsicherheit	R10/A	R11/B	R11V4	R12	R12V4		
Belastung	3	3	3	3	3		
tiefanthrazit	434216 Preisgr. A119 (m ²)	434219 Preisgr. A119 (m ²)	434222 Preisgr. A139 (m ²)	434225 Preisgr. A139 (m ²)	434228 Preisgr. A139 (m ²)		
mittelgrau	434217 Preisgr. A119 (m ²)	434220 Preisgr. A119 (m ²)	434223 Preisgr. A139 (m ²)	434226 Preisgr. A139 (m ²)	434229 Preisgr. A139 (m ²)		
hellbeige	434218 Preisgr. A119 (m ²)	434221 Preisgr. A119 (m ²)	434224 Preisgr. A139 (m ²)	434227 Preisgr. A139 (m ²)	434230 Preisgr. A139 (m ²)		
basalt	434326 Preisgr. A119 (m ²)	434328 Preisgr. A119 (m ²)	434330 Preisgr. A139 (m ²)	434332 Preisgr. A139 (m ²)	434334 Preisgr. A139 (m ²)		



Wand-/
Bodenfliesen

30 x 30 cm 20 x 20 cm¹ 20 x 20 cm¹ 20 x 20 cm¹ 20 x 20 cm¹ 20 x 20 cm¹ **NEU** 20 x 20 cm¹ **NEU**



protected

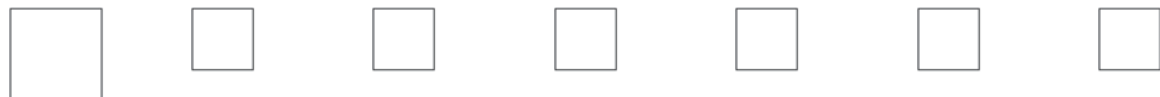

	<i>eben</i>	<i>eben, überstark</i>	<i>Softcorn 2, überstark</i>	<i>Perlstic, überstark</i>	<i>Carostic, überstark</i>	<i>Picstic, überstark</i>	<i>Geraut, überstark</i>
Nennmaß - cm/in	30 x 30 / 12 x 12	20 x 20 / 8 x 8	20 x 20 / 8 x 8	20 x 20 / 8 x 8	20 x 20 / 8 x 8	20 x 20 / 8 x 8	20 x 20 / 8 x 8
Herstellmaß	297 x 297 x 10,5 mm	197 x 197 x 15 mm	197 x 197 x 15 mm	197 x 197 x 15 mm	197 x 197 x 15 mm	197 x 197 x 15 mm	197 x 197 x 15 mm
Oberfläche	eben, matt	eben, matt	strukturiert, matt	gekörnt, matt	gekörnt, matt	eben, matt	profiliert, matt
m ² /m - Stück	11,111/m ²	25,767/m ²	25,767/m ²	25,767/m ²	25,767/m ²	25,767/m ²	25,767/m ²
m ² /m - kg	23,144/m ²	34,322/m ²	34,322/m ²	34,322/m ²	34,322/m ²	34,322/m ²	34,322/m ²
Paket - Stück	11	15	15	15	15	15	15
Paket - m ² /m	0,990 m ²	0,582 m ²	0,582 m ²	0,582 m ²	0,582 m ²	0,582 m ²	0,582 m ²
Paket - kg	22,913	19,980	19,980	19,980	19,980	19,980	19,980
Palette - m ²	47,520	34,928	34,928	34,928	34,928	34,928	34,928
Palette - kg	1.099,824	1.198,800	1.198,800	1.198,800	1.198,800	1.198,800	1.198,800
Produktnorm	Bla	Bla	Bla	Bla	Bla	Bla	Bla
Trittsicherheit	R10/A	R10/A	R11/B	R12	R12V4	R12V8	R13
Belastung	3	4	4	4	4	4	4
tiefanthrazit	434239 Preisgr. A94 (m ²)	434231 Preisgr. A139 (m ²)	434233 Preisgr. A150 (m ²)	434235 Preisgr. A150 (m ²)	434237 Preisgr. A150 (m ²)	434976 Preisgr. A150 (m ²)	434978 Preisgr. A150 (m ²)
mittelgrau	434240 Preisgr. A94 (m ²)	434232 Preisgr. A139 (m ²)	434234 Preisgr. A150 (m ²)	434236 Preisgr. A150 (m ²)	434238 Preisgr. A150 (m ²)	434977 Preisgr. A150 (m ²)	434979 Preisgr. A150 (m ²)
hellbeige	434241 Preisgr. A94 (m ²)						
basalt	434336 Preisgr. A94 (m ²)						



¹ Lieferzeit auf Anfrage

Sockel mit
Fase

Treppenfliesen

20 x 20 cm¹ **NEU**

27,8 x 20 cm² **NEU**

10 x 20 cm

30 x 30 cm³



Kombicorn,
überstark

Sicherheitsdreiecke,
überstark



protected

			20 x 20 / 8 x 8	27,8 x 20 / 11 x 8	10 x 20 / 4 x 8	30 x 30 / 12 x 12	Nennmaß - cm/in
			197 x 197 x 15 mm	278 x 197/197 x 15 mm	97 x 197 x 10,5 mm	297 x 297 x 10,5 mm	Herstellmaß
			profiliert, matt	gekörnt, matt	eben, matt	eben, matt	Oberfläche
			25,767/m ²	3,597/1,798/m	5,000/m	3,333/m	m ² / m - Stück
			34,322/m ²	2,374/1,187/m	2,250/m	6,943/m	m ² / m/St. - kg
			15	28	20	10	Paket - Stück
			0,582 m ²	7,784/15,573 m	4,000 m	3,003 m	Paket - m/m ²
			19,980	18,480	9,000	20,830	Paket - kg
			34,928				Palette - m ²
			1.198,800				Palette - kg
			Bla	Bla	Bla	Bla	Produktnorm
			R13V10	R11	R10/A		Trittsicherheit
			4	4		3	Belastung
			434980		434248	434251	tiefanthrazit
			Preisgr. A150 (m ²)		Preisgr. A416 (St.)	Preisgr. A449 (St.)	
			434981		434249	434252	mittelgrau
			Preisgr. A150 (m ²)		Preisgr. A416 (St.)	Preisgr. A449 (St.)	
					434250	434253	hellbeige
					Preisgr. A416 (St.)	Preisgr. A449 (St.)	
					434342	434344	basalt
					Preisgr. A416 (St.)	Preisgr. A449 (St.)	
				431321			gelb
				Preisgr. A416 (St.)			
				431320			schwarz
				Preisgr. A416 (St.)			

¹ Lieferzeit auf Anfrage

² Angabe der logistischen Daten für einreihige bzw. doppelreihige Verlegung

³ Auftragsfertigung: Rückgabe und/oder Stornierung bestellter Ware nicht möglich.



Kehlsockel¹

Innenecke
zu Kehlsockel
1/2

Außenecke
zu Kehlsockel
1/2

10 x 20 cm

10 x 30 cm



protected

			10 x 20 / 4 x 8	10 x 30 / 4 x 12			Nennmaß - cm/in
			102 x 197 x 9 mm	102 x 297 x 9 mm	102 x 20 x 9 mm	102 x 35 x 9 mm	Herstellmaß
			eben, matt	eben, matt	eben, matt	eben, matt	Oberfläche
			5,000	3,333			m - Stück
			2,000/m	2,000/m	0,080/Stück	0,080/Stück	m/St. - kg
			20	16	18	12	Paket - Stück
			4,000	4,801			Paket - m
			8,000	9,600			Paket - kg
							Palette - m
							Palette - kg
			Bla	Bla	Bla	Bla	Produktnorm
			R10/A	R10/A			Trittsicherheit
			432027	432033	432039	432045	tiefanthrazit
			Preisgr. A419 (St.)	Preisgr. A425 (St.)	Preisgr. A418 (St.)	Preisgr. A418 (St.)	
			432028	432034	432040	432046	mittelgrau
			Preisgr. A419 (St.)	Preisgr. A425 (St.)	Preisgr. A418 (St.)	Preisgr. A418 (St.)	
			432029	432035	432041	432047	hellbeige
			Preisgr. A419 (St.)	Preisgr. A425 (St.)	Preisgr. A418 (St.)	Preisgr. A418 (St.)	
			432030	432036	432042	432048	basalt
			Preisgr. A419 (St.)	Preisgr. A425 (St.)	Preisgr. A418 (St.)	Preisgr. A418 (St.)	

¹ Details siehe Seite 483 ff.

² passend zu Kehlsockel 10 x 20 / 10 x 30 cm







Innovativ und robust

Spezialisten leisten mehr. Das gilt auch für die keramischen Bodenplatten der Serie Ferrum, die eigens für die harten Anforderungen industrieller Betriebe entwickelt wurden. Die durchgefärbten, unglasierten Spaltplatten sind besonders trittsicher und beugen dadurch Arbeitsunfällen vor. Sie sind extrem robust und übertreffen die Druckfestigkeit von Beton oder Beschichtungsstoffen um ein Vielfaches. Ein technisch ausgefeiltes Zubehörprogramm, das Kehlsockel, Schenkelplatten und Flachrinnen umfasst, erleichtert die Realisation betriebsspezifischer Komplettlösungen.



grauweiß



graubeige



steingrau



braunpalette



hellbeige
granuliert

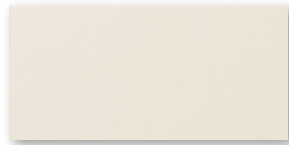

Bodenplatte 25 x 12,5 cm



Schenkelplatte
25 x 12,5 cm

Kehlsockel, $r = 25 \text{ mm}$,
25 x 12,5 cm

Außenecke



Innenecke

Überstärken bis 40 mm sind als Sonderfertigungen lieferbar.

Bodenplatten

25 x 12,5 cm



25 x 12,5 cm²



25 x 12,5 cm



	11 mm stark	14 mm stark	20 mm stark	
	1100	1160	1110	Formatnummer
	25 x 12,5 / 10 x 5	25 x 12,5 / 10 x 5	25 x 12,5 / 10 x 5	Nennmaß - cm/in
	240 x 115 x 11 mm	240 x 115 x 14 mm	240 x 115 x 20 mm	Herstellmaß
	eben, matt ⁴	eben, matt ⁴	eben, matt ⁴	Oberfläche
	33,000	33,000	33,000	m ² - Stück
	22,869	28,380	41,679	m ² - kg
	24	20	14	Paket - Stück
	0,727	0,606	0,424	Paket - m ²
	16,632	17,200	17,682	Paket - kg
	52,364	43,636	30,545	Palette - m ²
	1.197,504	1.238,400	1.273,104	Palette - kg
	Alb	Alb	Alb	Produktnorm
	siehe unten	siehe unten	siehe unten	Trittsicherheit
	2	3	4	Belastung
	R10/A	R10/A	R10/A	
	900-1100	900-1160	900-1110	graubeige
	Preisgr. A101 (m ²)	Preisgr. A125 (m ²)	Preisgr. A150 (m ²)	
	R11/B	R11/B	R11/B	
	902R-1100	902R-1160	902R-1110	grauweiß
	Preisgr. A101 (m ²)	Preisgr. A125 (m ²)	Preisgr. A150 (m ²)	
	R11/B	R11/B	R11/B	
	929R-1100	929R-1160	929R-1110	steingrau
	Preisgr. A119 (m ²)	Preisgr. A139 (m ²)	Preisgr. A162 (m ²)	
			R11/B	
			950-1110¹	braunpalette
			Preisgr. A150 (m ²)	
	R11/A	R11/A	R11/A	
	964-1100	964-1160	964-1110	hellbeige granuliert
	Preisgr. A119 (m ²)	Preisgr. A139 (m ²)	Preisgr. A162 (m ²)	

² Auftragsfertigung: Rückgabe und/oder Stornierung bestellter Ware nicht möglich.



⁴ Ausnahme: hellbeige granuliert: strukturiert, matt

Sockelsystem

Schenkelplatte

25 x 12,5 cm



25 x 12,5 cm³



Kehlsockel
r= 25 mm

Außenecke

Innenecke

	Kehlsockel r= 25 mm	Außenecke	Innenecke	
	4030	4033	4034	4822
	25 x 12,5 / 10 x 5			25 x 12,5 / 10 x 5
	240 x 125/20 x 11 mm			240 x 115/52 x 11 mm
	eben, matt	eben, matt	eben, matt	eben, matt
	4,000			4,000
	3,520/m	0,200/Stück	0,170/Stück	3,880/m
	14	4	8	8
	3,500			2,000
	12,320	0,800	1,360	7,760
	Alb	Alb	Alb	Alb
				siehe unten
				R10/A
	900-4030	900-4033	900-4034	900-4822
	Preisgr. A434 (St.)	Preisgr. A445 (St.)	Preisgr. A445 (St.)	Preisgr. A434 (St.)
				R11/B
	902R-4030	902R-4033	902R-4034	902R-4822
	Preisgr. A434 (St.)	Preisgr. A445 (St.)	Preisgr. A445 (St.)	Preisgr. A434 (St.)
				R11/B
	929R-4030	929R-4033	929R-4034	929R-4822
	Preisgr. A434 (St.)	Preisgr. A445 (St.)	Preisgr. A445 (St.)	Preisgr. A434 (St.)
	950-4030¹	950-4033¹	950-4034¹	
	Preisgr. A434 (St.)	Preisgr. A445 (St.)	Preisgr. A445 (St.)	

¹ Ausnahme: Farbe braunpalette fällt unter die DIN EN 14411, Gruppe Al_a.

³ Auf Anfrage auch in Farbe hellbeige granuliert lieferbar

Flachrinnensystem (Muldentiefe 15 mm) siehe Kapitel Pool + SPA – Serie Spezialplatten S. 434.

Hinweis: Oberfläche mit einer geeigneten Imprägnierung behandeln! Siehe technische Informationen S. 474







Frisch und modern

Fresh bietet eine stimmige Palette an modernen, frischen Farben in den beliebten Mosaikformaten 2,5 x 2,5 cm und 5 x 5 cm, mit denen individuelle, aber zugleich auch unkompliziert zu realisierende Gestaltungen möglich werden. Besonders praktisch ist dabei: Zu den Fliesen gibt es farblich passende rutschhemmende Mosaik in R10/B.

Fresh: moderne Klarheit für individuelle Gestaltung

snow white	warm grey mix	desert sand-mix	taupe-mix	white grey mix	silver grey mix	light grey-mix	medium grey-mix	midnight black-mix	graphite black mix	deep blue mix	carribbean blue mix
------------	---------------	-----------------	-----------	----------------	-----------------	----------------	-----------------	--------------------	--------------------	---------------	---------------------

2,5 x 2,5 cm

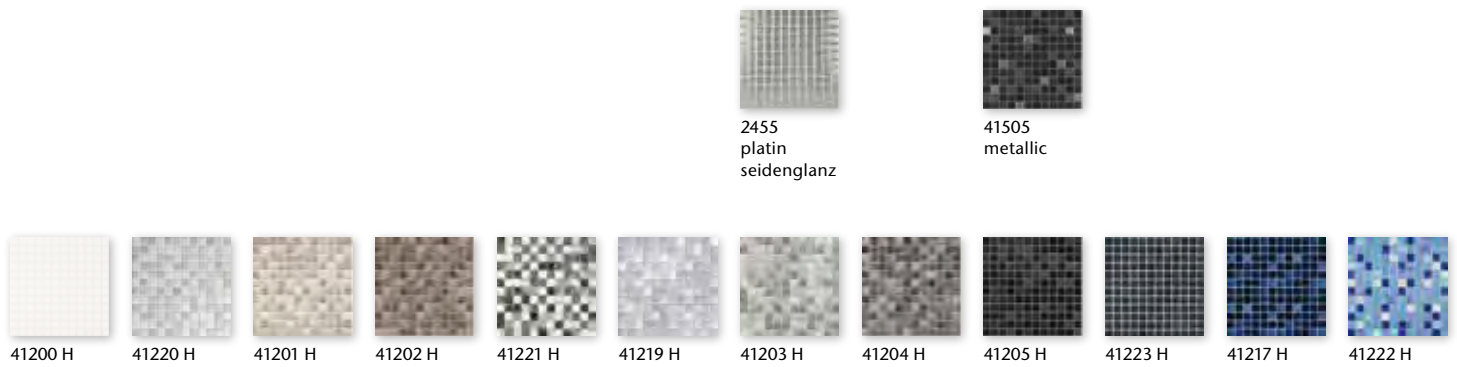

2,5 x 2,5 cm non-slip R10/B



5 x 5 cm non-slip R10/B & R11/C



denim blue-mix	light blue-mix	pacific blue-mix	midnight blue-mix	vivid violet-mix	sunset orange-mix	coral red-mix	brick red mix	mystic red-mix	forest green mix	lime green-mix	sunshine yellow-mix
----------------	----------------	------------------	-------------------	------------------	-------------------	---------------	---------------	----------------	------------------	----------------	---------------------

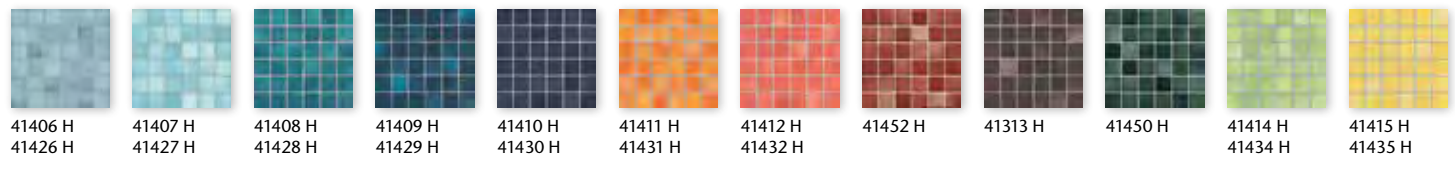
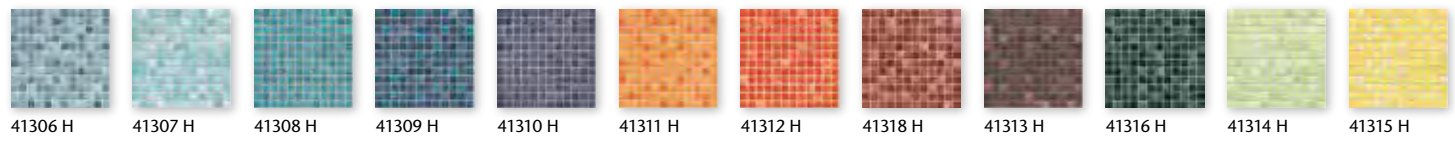
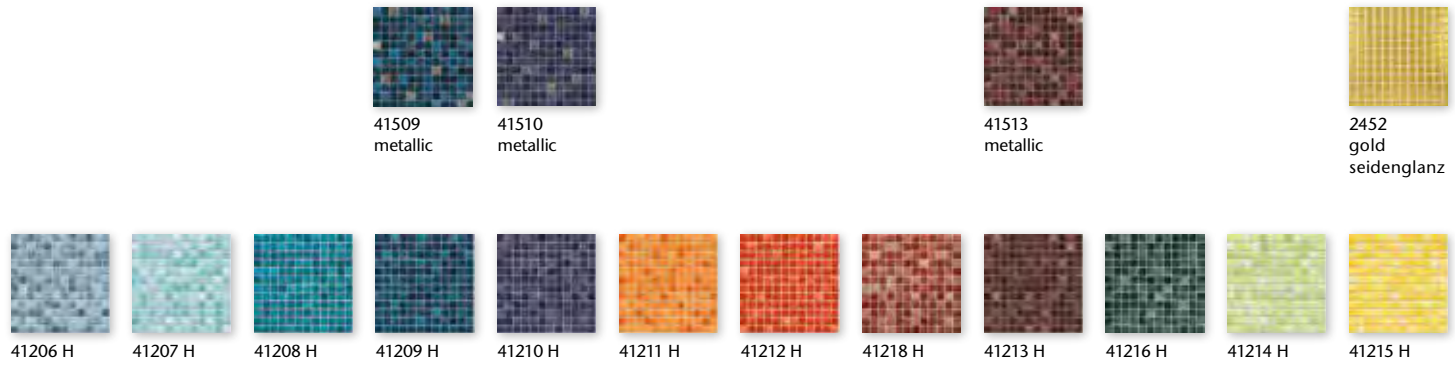

Mosaik 2,5 x 2,5 cm



snow white

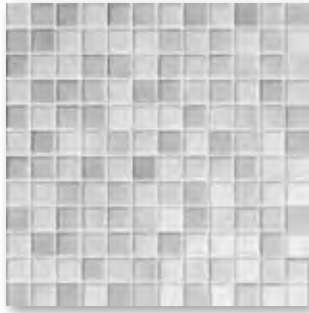

warm grey mix

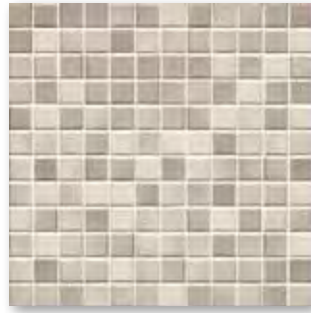

desert sand-mix



taupe-mix



white grey mix

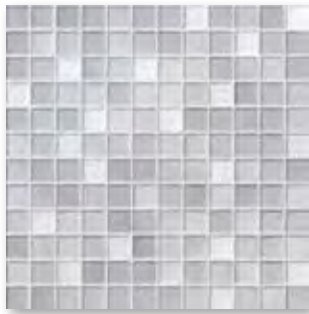

silver grey mix

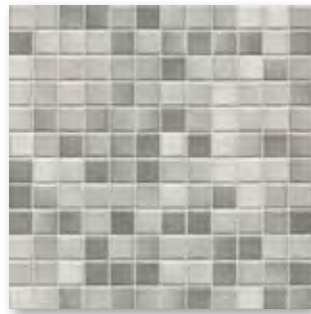

light grey-mix



medium grey-mix

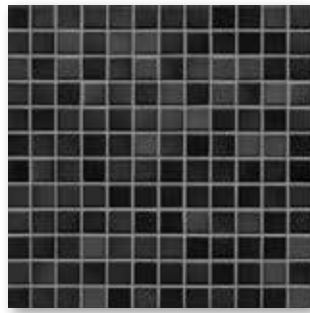

midnight black-mix



graphite black mix



deep blue mix

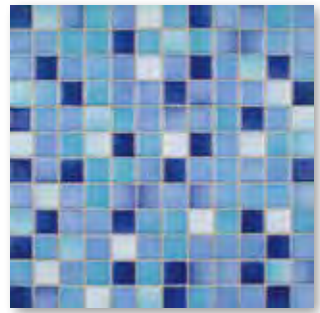

caribbean blue mix

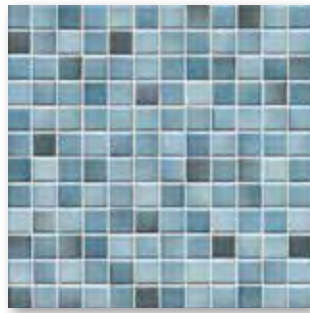

denim blue-mix



light blue-mix

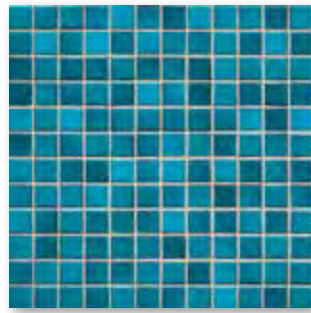

pacific blue-mix

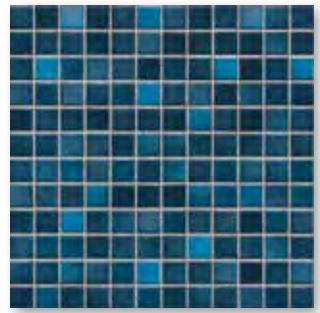

midnight blue-mix

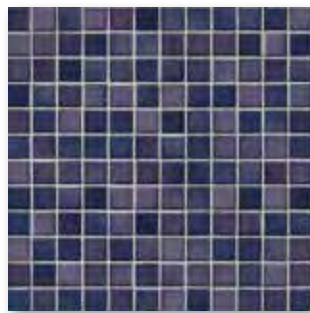

vivid violet-mix

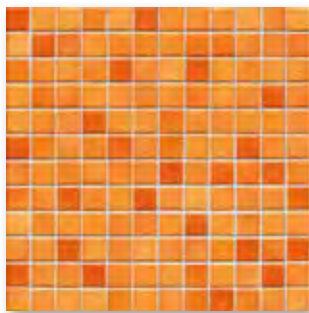

sunset orange-mix

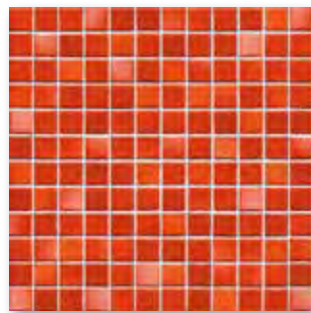

coral red-mix

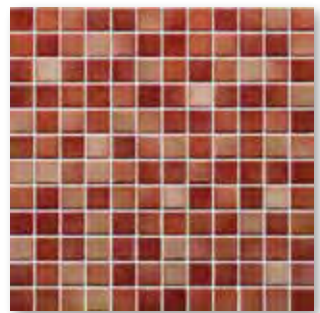

brick red mix

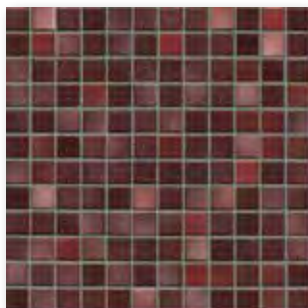

mystic red-mix, glänzend



forest green mix, glänzend

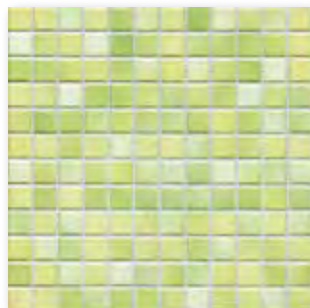

lime green-mix, glänzend

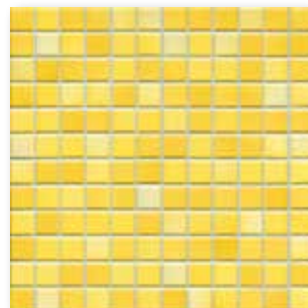

sunshine yellow-mix, glänzend



*midnight black-mix metallic, glänzend **

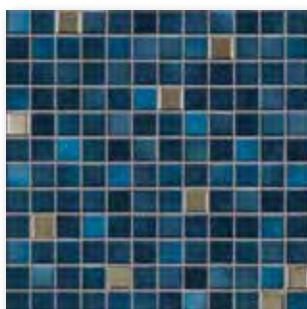

*midnight blue-mix metallic, glänzend **

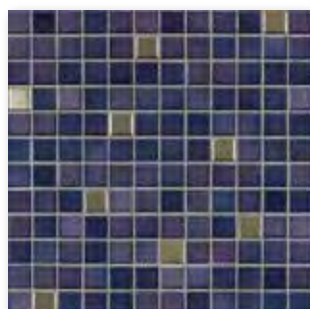

*vivid violet-mix metallic, glänzend **

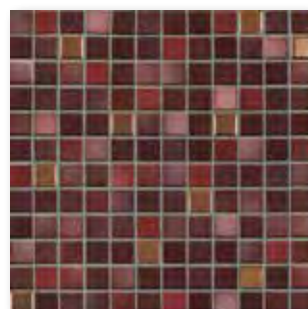

mystic red-mix metallic, glänzend

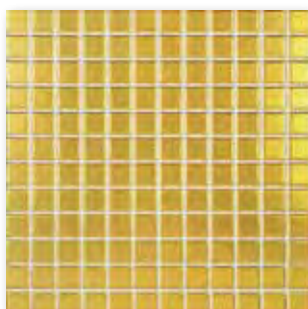

*gold, seidenglanz **

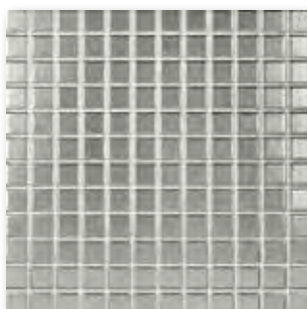

*platin, seidenglanz **

* Zur Vermeidung des Abriebs der Oberflächenbeschichtung ist von einer Bodenbelegung oder sonstiger vergleichbarer Beanspruchung zwingend abzusehen.

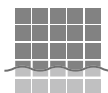

Rückseitig thermoplastisch verklebte Mosaik von AGROB BUCHTAL sind nicht nur im Trockenbereich, sondern auch bedenkenlos im Unterwasserbereich (z. B. Schwimmbecken/Whirlpool) sowie im dauermassbelasteten Bereich (z. B. Beckenumgänge/Duschen) einsetzbar.

Projekt: Hallenbad / Standort: Oberuzwil, Schweiz /
Architekt: Hunziker Betatech AG / Serie: Fresh / Foto: Adrian Faragulo



Farbverlauf 2,5 x 2,5 cm

 41520H
aqua glänzend

Weitere Beispiele

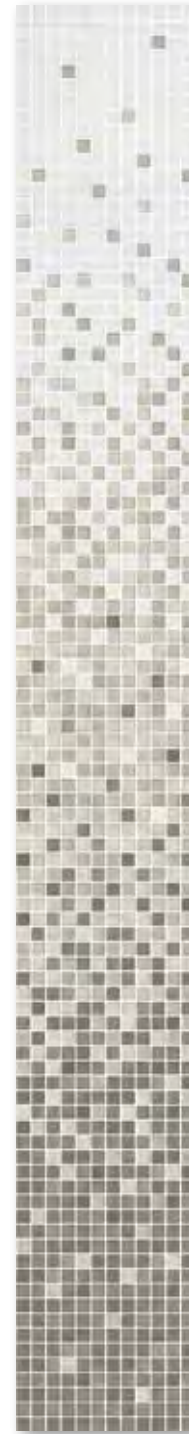

Farbverläufe können individuell gestaltet werden.
Gerne prüfen wir die Möglichkeiten einer solchen
Sonderproduktion im Einzelfall.

Herstellmaß ohne Außenfuge:
297 x 2376 x 6,5 mm



Mosaik 2,5 x 2,5 cm, non-slip



snow white



warm grey mix

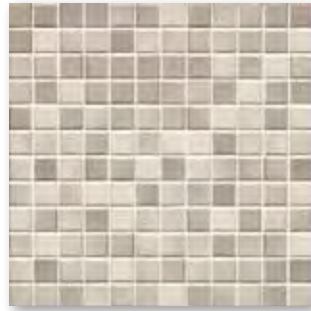

desert sand-mix



taupe-mix

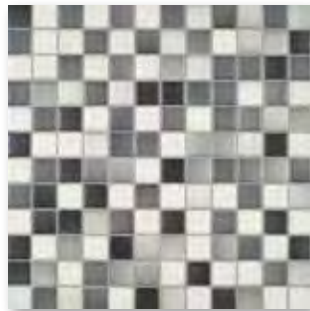

white grey mix



silver grey mix

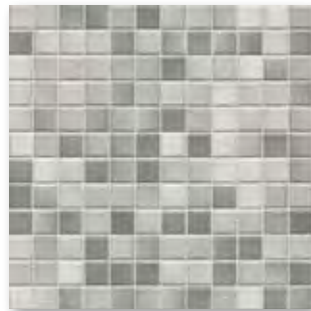

light grey-mix



medium grey-mix

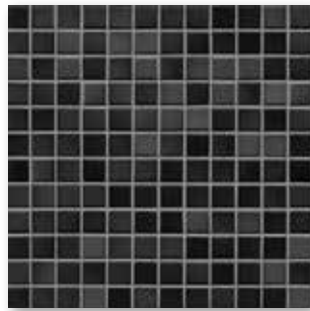

midnight black-mix



graphite black mix

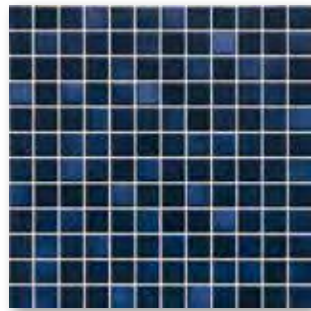

deep blue mix

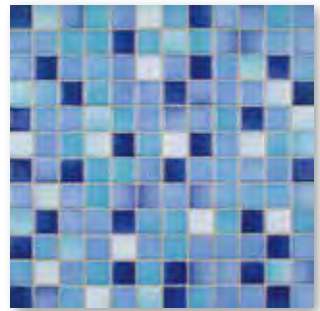

caribbean blue mix

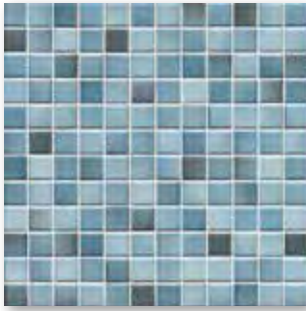

denim blue-mix



light blue-mix

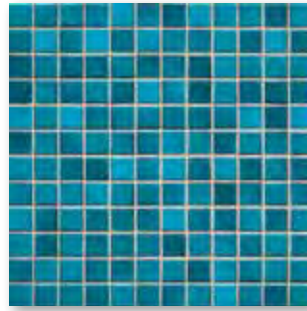

pacific blue-mix

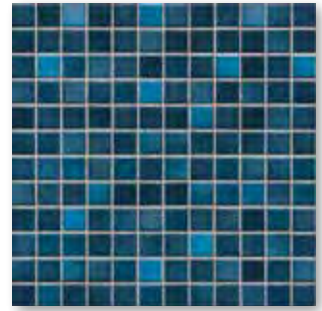

midnight blue-mix

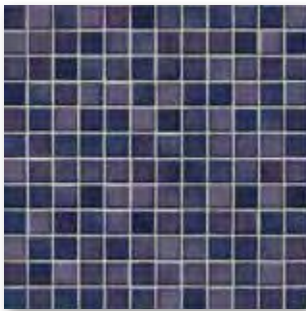

vivid violet-mix

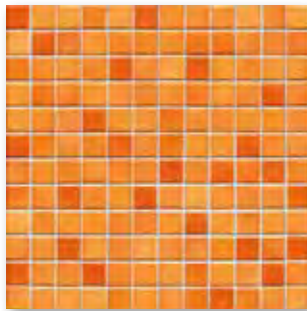

sunset orange-mix

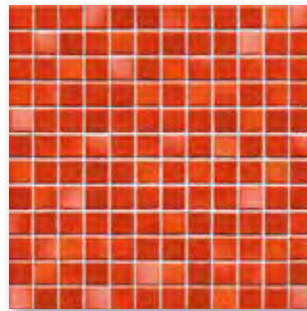

coral red-mix

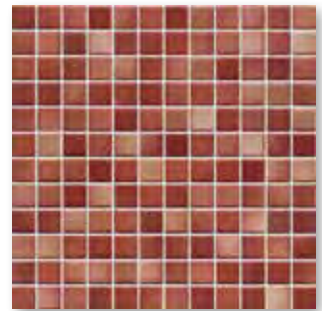

brick red mix

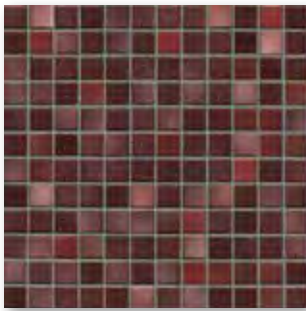

mystic red-mix



forest green mix

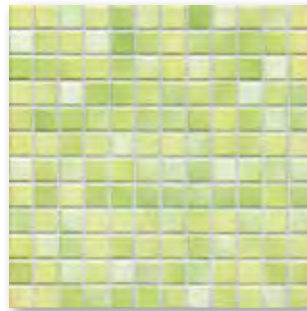

lime green-mix

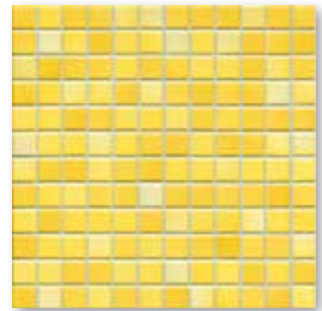

sunshine yellow-mix

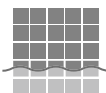

Rückseitig thermoplastisch verklebte Mosaik von AGROB BUCHTAL sind nicht nur im Trockenbereich, sondern auch bedenkenlos im Unterwasserbereich (z. B. Schwimmbecken/Whirlpool) sowie im dauermassbelasteten Bereich (z. B. Beckenumgänge/Duschen) einsetzbar.



Mosaik 5 x 5 cm, non-slip



snow white



warm grey mix



desert sand-mix



taupe-mix



white grey mix



silver grey mix



light grey-mix



medium grey-mix



midnight black-mix



graphite black mix



deep blue mix

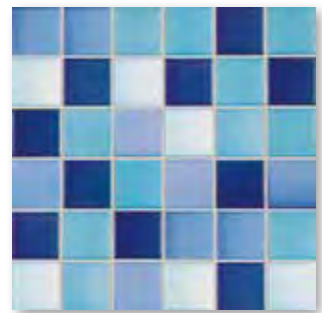

caribbean blue mix

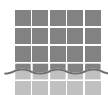

Rückseitig thermoplastisch verklebte Mosaik von AGROB BUCHTAL sind nicht nur im Trockenbereich, sondern auch bedenkenlos im Unterwasserbereich (z. B. Schwimmbecken/Whirlpool) sowie im dauernassbelasteten Bereich (z. B. Beckenumgänge/Duschen) einsetzbar.



denim blue-mix



light blue-mix

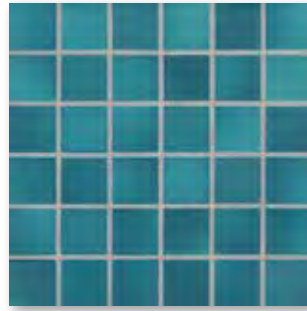

pacific blue-mix

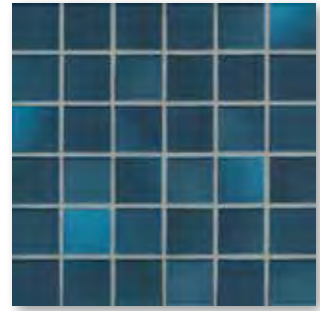

midnight blue-mix



vivid violet-mix

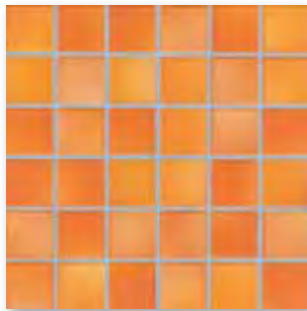

sunset orange-mix

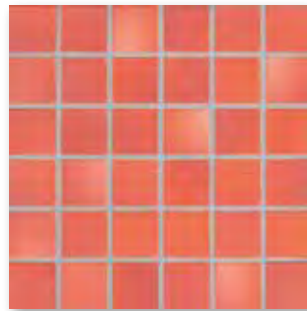

coral red-mix



brick red mix

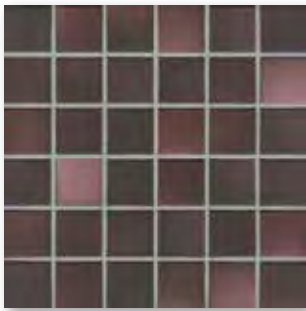

mystic red-mix



forest green mix

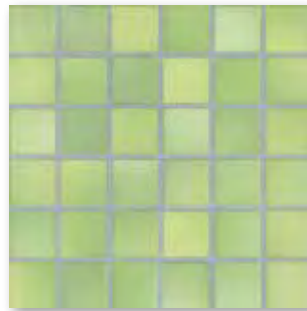

lime green-mix

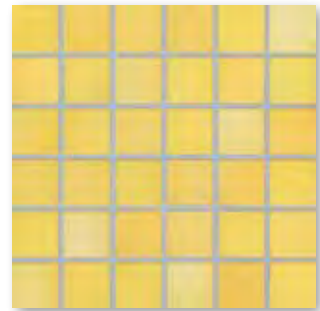

sunshine yellow-mix

Mosaik

Farbverlauf¹

2,5 x 2,5 cm

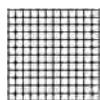

2,5 x 2,5 cm



Mosaik, rückseitig
thermoplastisch verklebt
Bogen: 297 x 297 mm

Mosaik, rückseitig
thermoplastisch verklebt
Bogen: 297 x 297 mm

Nennmaß - cm/in	2,5 x 2,5 / 1 x 1	2,5 x 2,5 / 1 x 1				
Herstellmaß	23 x 23 x 6,5 mm	23 x 23 x 6,5 mm				
Oberfläche	eben, glänzend	eben, glänzend				
m ² - Stück	11 Bögen	11 Bögen				
m ² - kg	12,100					
Paket - Stück	11 Bögen	8 Bögen				
Paket - m ²	1,000	0,800				
Paket - kg	12,100	8,800				
Palette - m ²	48,000					
Palette - kg	580,800					
Produktnorm	Blb	Blb				
Trittsicherheit						
Belastung	1 - 2	1 - 2				
	3					
snow white	41200H Preisgr. A205 (m ²)					
desert sand-mix	3 41201H Preisgr. A205 (m ²)					
taupe-mix	3 41202H Preisgr. A205 (m ²)					
light grey-mix	3 41203H Preisgr. A205 (m ²)					
medium grey-mix	3 41204H Preisgr. A205 (m ²)					
midnight black-mix	2 41205H Preisgr. A205 (m ²)					
denim blue-mix	3 41206H Preisgr. A230 (m ²)					
light blue-mix	3 41207H Preisgr. A230 (m ²)					
pacific blue-mix	3 41208H Preisgr. A230 (m ²)					
midnight blue-mix	3 41209H Preisgr. A230 (m ²)					
vivid violet-mix	2 41210H Preisgr. A230 (m ²)					
sunset orange-mix	3 41211H Preisgr. A230 (m ²)					
coral red-mix	3 41212H Preisgr. A230 (m ²)					
mystic red-mix	2 41213H Preisgr. A230 (m ²)					
lime green-mix	3 41214H Preisgr. A230 (m ²)					
sunshine yellow-mix	4 41215H Preisgr. A230 (m ²)					
aqua glänzend	3	41520H² Preisgr. A750 (St.)				



¹ Herstellmaß ohne Außenfuge: 297 x 2376 mm
Preisangabe bezieht sich auf den Farbverlauf = 8 Bögen
Farbverläufe können individuell gestaltet werden. Gerne prüfen wir die Möglichkeiten einer solchen Sonderproduktion im Einzelfall.

Mosaik

2,5 x 2,5 cm

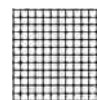

Mosaik, rückseitig
thermoplastisch verklebt
Bogen: 297 x 297 mm



					2,5 x 2,5 / 1 x 1	Nennmaß - cm/in	
					23 x 23 x 6,5 mm	Herstellmaß	
					eben, glänzend	Oberfläche	
					11 Bögen	m ² - Stück	
					12,100	m ² - kg	
					11 Bögen	Paket - Stück	
					1,000	Paket - m ²	
					12,100	Paket - kg	
					48,000	Palette - m ²	
					580,800	Palette - kg	
					Blb	Produktnorm	
					1 - 2	Trittsicherheit	
					41216H	Belastung	
					Preisgr. A230 (m ²)	2 forest green mix NEU	
					41217H	2 deep blue mix NEU	
					Preisgr. A230 (m ²)	2 brick red mix NEU	
					41218H	3 silver grey mix NEU	
					Preisgr. A230 (m ²)	3 warm grey mix NEU	
					41219H	2 white grey mix NEU	
					Preisgr. A230 (m ²)	2 carribbian NEU	
					41220H	2 blue mix NEU	
					Preisgr. A230 (m ²)	2 graphite NEU	
					41221H	black mix NEU	
					Preisgr. A230 (m ²)	midnight black-mix metallic glänzend	
					41222H	midnight blue-mix metallic glänzend	
					Preisgr. A230 (m ²)	vivid violet-mix metallic glänzend	
					41223H	mystic red-mix metallic glänzend	
					Preisgr. A230 (m ²)	gold	
					41505	Preisgr. A458 (St.)	seidenglanz
					41509	Preisgr. A458 (St.)	platin
					41510	Preisgr. A458 (St.)	seidenglanz
					41513 ¹	Preisgr. A458 (St.)	
					2452	Preisgr. A391 (m ²)	
					2455	Preisgr. A391 (m ²)	

¹ Nicht oder nur bedingt säure- und laugenbeständig



Mosaik non-slip

2,5 x 2,5 cm

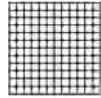

5 x 5 cm

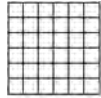

5 x 5 cm

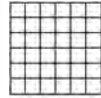
Mosaik, rückseitig
thermoplastisch verklebt
Bogen: 297 x 297 mmMosaik, rückseitig
thermoplastisch verklebt
Bogen: 297 x 297 mmMosaik, rückseitig
thermoplastisch verklebt
Bogen: 297 x 297 mm

Nennmaß - cm/in	Herstellmaß	Oberfläche	m ² - Stück	m ² - kg	Paket - Stück	Paket - m ²	Paket - kg	Palette - m ²	Palette - kg	Produktnorm	Belastung	Beanspruchungsgruppe			
												2,5 x 2,5 / 1 x 1	5 x 5 / 2 x 2	5 x 5 / 2 x 2	
	23 x 23 x 6,5 mm	eben, matt	10 Bögen	12,060	11 Bögen	1,000	12,100	48,000	580,800	Blb	R10/B	1 - 2	4	4	4
41300H	47 x 47 x 6,5 mm	eben, matt	11 Bögen	12,331	11 Bögen	1,000	12,331	64,000	789,184	Blb	R10/B	1 - 2	4	4	4
41400H-73	47 x 47 x 6,5 mm	eben, matt	11 Bögen	12,331	11 Bögen	1,000	12,331	64,000	789,184	Blb	R11/C	1 - 2	4	4	4
41420H															
41301H															
41401H-73															
41421H															
41302H															
41402H-73															
41422H															
41303H															
41403H-73															
41423H															
41304H															
41404H-73															
41424H															
41305H															
41405H-73															
41425H															
41306H															
41406H															
41426H															
41307H															
41407H															
41427H															
41308H															
41408H															
41428H															
41309H															
41409H															
41429H															
41310H															
41410H															
41430H															
41311H															
41411H															
41431H															
41312H															
41412H															
41432H															
41313H															
41413H															
41433H															
41314H															
41414H															
41434H															
41315H															
41415H															
41435H															
41316H															
41450H															
41317H															
41451H															
41318H															
41452H															
41319H															
41453H															
41320H															
41454H															
41321H															
41455H															
41322H															
41456H															
41323H															
41457H															









Hommage ans Handwerk

Die erst vor wenigen Jahren eingeführte Mosaikkollektion Karl ist so erfolgreich, dass sie jetzt nicht nur durch ein modernes 10 x 25 Riegelformat ergänzt wurde. Auch das Farbspektrum der Karl wurde durch fünf neue Farben erweitert. Insgesamt interpretiert Karl altes Handwerk neu. Mit ursprünglich wirkenden Glasuren und einer speziellen Rezeptur der Rohstoffe. So entsteht beim Brennen für jede Fliese ein individuelles Fliesenbild. In der Fläche strahlt Karl authentische und elementare Anziehungskraft aus. Mit Assoziationen an das einfache Leben und dem Fokus aufs Wesentliche. Die glasierte Variante empfiehlt sich für die Gestaltung von Wänden. Die steinmatte Version mit Rutschhemmung R10/B für den Boden. Als passende Bodenfliese bietet sich die Serie Stories an.

Mosaik 2,5 x 2,5 cm

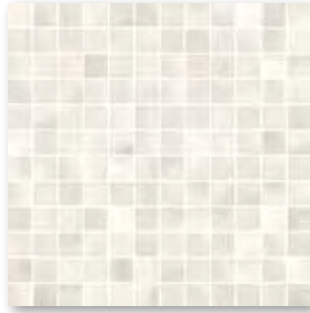

Mosaik, white, strukturiert, glänzend, 2,5 x 2,5 cm, und Mosaik, strukturiert, matt 2,5 x 2,5 cm, trittsicher R10/B



Mosaik, nude, strukturiert, glänzend, 2,5 x 2,5 cm, und Mosaik, strukturiert, matt 2,5 x 2,5 cm, trittsicher R10/B

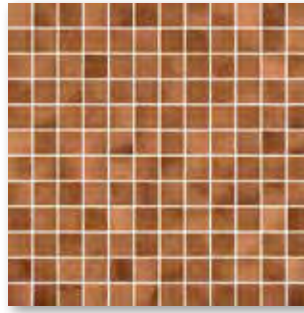

Mosaik, terra, strukturiert, glänzend, 2,5 x 2,5 cm, und Mosaik, strukturiert, matt 2,5 x 2,5 cm, trittsicher R10/B

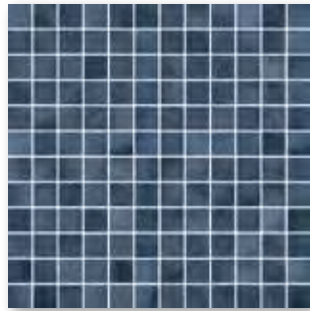

Mosaik, indigo, strukturiert, glänzend, 2,5 x 2,5 cm, und Mosaik, strukturiert, matt 2,5 x 2,5 cm, trittsicher R10/B

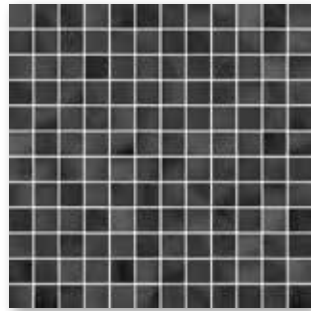

Mosaik, black, strukturiert, glänzend, 2,5 x 2,5 cm, und Mosaik, strukturiert, matt 2,5 x 2,5 cm, trittsicher R10/B

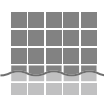

Rückseitig thermoplastisch verklebte Mosaik von AGROB BUCHTAL sind nicht nur im Trockenbereich, sondern auch bedenkenlos im Unterwasserbereich (z. B. Schwimmbecken/Whirlpool) sowie im dauernassbelasteten Bereich (z. B. Beckenumgänge/Duschen) einsetzbar.

Mosaik 10 x 10 cm



Mosaik, white, strukturiert, glänzend,
10 x 10 cm, und Mosaik, strukturiert, matt
10 x 10 cm, trittsicher R10/B



Mosaik, nude, strukturiert, glänzend,
10 x 10 cm, und Mosaik, strukturiert, matt
10 x 10 cm, trittsicher R10/B

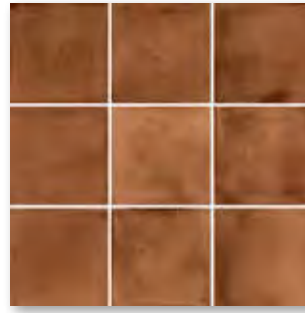

Mosaik, terra, strukturiert, glänzend,
10 x 10 cm, und Mosaik, strukturiert, matt
10 x 10 cm, trittsicher R10/B

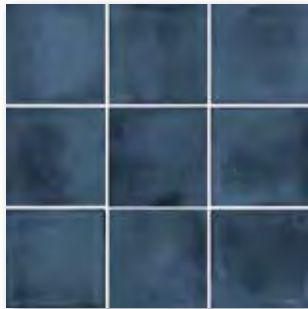

Mosaik, indigo, strukturiert, glänzend,
10 x 10 cm, und Mosaik, strukturiert, matt
10 x 10 cm, trittsicher R10/B

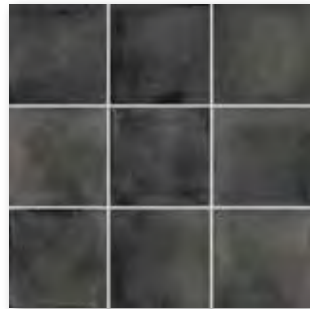

Mosaik, black, strukturiert, glänzend,
10 x 10 cm, und Mosaik, strukturiert, matt
10 x 10 cm, trittsicher R10/B

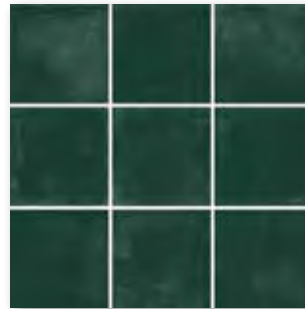

Mosaik, forest, strukturiert, glänzend,
10 x 10 cm, und Mosaik, strukturiert, matt
10 x 10 cm, trittsicher R10/B



Mosaik, grey green, strukturiert, glänzend,
10 x 10 cm, und Mosaik, strukturiert, matt
10 x 10 cm, trittsicher R10/B

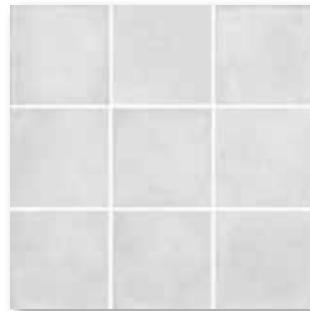

Mosaik, grey, strukturiert, glänzend,
10 x 10 cm, und Mosaik, strukturiert, matt
10 x 10 cm, trittsicher R10/B



Mosaik, aqua, strukturiert, glänzend,
10 x 10 cm, und Mosaik, strukturiert, matt
10 x 10 cm, trittsicher R10/B



Mosaik, ocean blue, strukturiert, glänzend,
10 x 10 cm, und Mosaik, strukturiert, matt
10 x 10 cm, trittsicher R10/B

Wandfliesen 10 x 25 cm



Wandfliese, white, strukturiert, glänzend,
10 x 25 cm

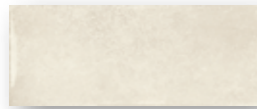

Wandfliese, nude, strukturiert, glänzend,
10 x 25 cm



Wandfliese, terra, strukturiert, glänzend,
10 x 25 cm



Wandfliese, indigo, strukturiert, glänzend,
10 x 25 cm



Wandfliese, black, strukturiert, glänzend,
10 x 25 cm



Wandfliese, forest, strukturiert, glänzend,
10 x 25 cm



Wandfliese, grey green, strukturiert, glänzend,
10 x 25 cm

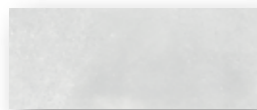

Wandfliese, grey, strukturiert, glänzend,
10 x 25 cm

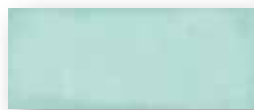

Wandfliese, aqua, strukturiert, glänzend,
10 x 25 cm



Wandfliese, ocean blue, strukturiert, glänzend,
10 x 25 cm

Mosaik

Wand-**NEU**
fliese

2,5 x 2,5 cm

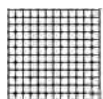

2,5 x 2,5 cm

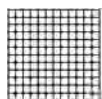

10 x 10 cm



10 x 10 cm



10 x 25 cm



Mosaik, rückseitig
thermoplastisch verklebt
Bogen: 297 x 297 mm

Mosaik, rückseitig
thermoplastisch verklebt
Bogen: 297 x 297 mm

Mosaik, rückseitig
thermoplastisch verklebt
Bogen: 297 x 297 mm

Mosaik, rückseitig
thermoplastisch verklebt
Bogen: 297 x 297 mm



	2,5 x 2,5 / 1 x 1	2,5 x 2,5 / 1 x 1	10 x 10 / 4 x 4	10 x 10 / 4 x 4	10 x 25 / 4 x 10	Nennmaß - cm/in
	23 x 23 x 6,5 mm	23 x 23 x 6,5 mm	97 x 97 x 6,5 mm	97 x 97 x 6,5 mm	97 x 247 x 6,5 mm	Herstellmaß
	strukturiert, glänzend	strukturiert, matt	strukturiert, glänzend	strukturiert, matt	strukturiert, glänzend	Oberfläche
	11 Bögen	11 Bögen	11 Bögen	11 Bögen	40,000	m ² - Stück
	12,100	12,100	13,101	13,101	12,560	m ² - kg
	11 Bögen	11 Bögen	11 Bögen	11 Bögen	27	Paket - Stück
	1,000	1,000	1,000	1,000	0,675	Paket - m ²
	12,100	12,100	13,101	13,101	8,478	Paket - kg
	40,000	40,000	64,000	64,000	86,400	Palette - m ²
	484,000	484,000	838,464	838,464	1.058,184	Palette - kg
	Bla (GL)	Bla (UGL)	Bla (GL)	Bla (UGL)	Bla (GL)	Produktnorm
		R10/B		R10/B		Trittsicherheit
	1 - 2	1 - 2	1 - 2	1 - 2	1 - 2	Belastung
	47050H	47075H	47250H	47275H	47650H	white
	Preisgr. A222 (m ²)	Preisgr. A230 (m ²)	Preisgr. A113 (m ²)	Preisgr. A150 (m ²)	Preisgr. A113 (m ²)	
	47051H	47076H	47251H	47276H	47651H	nude
	Preisgr. A222 (m ²)	Preisgr. A230 (m ²)	Preisgr. A113 (m ²)	Preisgr. A150 (m ²)	Preisgr. A113 (m ²)	
	47052H	47077H	47252H	47277H	47652H	terra
	Preisgr. A222 (m ²)	Preisgr. A230 (m ²)	Preisgr. A113 (m ²)	Preisgr. A150 (m ²)	Preisgr. A113 (m ²)	
	47053H	47078H	47253H	47278H	47653H	indigo
	Preisgr. A222 (m ²)	Preisgr. A230 (m ²)	Preisgr. A113 (m ²)	Preisgr. A150 (m ²)	Preisgr. A113 (m ²)	
	47054H	47079H	47254H	47279H	47654H	black
	Preisgr. A222 (m ²)	Preisgr. A230 (m ²)	Preisgr. A113 (m ²)	Preisgr. A150 (m ²)	Preisgr. A113 (m ²)	
			47255H	47280H	47655H	forest NEU
			Preisgr. A113 (m ²)	Preisgr. A150 (m ²)	Preisgr. A113 (m ²)	
			47256H	47281H	47656H	grey green NEU
			Preisgr. A113 (m ²)	Preisgr. A150 (m ²)	Preisgr. A113 (m ²)	
			47257H	47282H	47657H	grey NEU
			Preisgr. A113 (m ²)	Preisgr. A150 (m ²)	Preisgr. A113 (m ²)	
			47258H	47283H	47658H	aqua NEU
			Preisgr. A113 (m ²)	Preisgr. A150 (m ²)	Preisgr. A113 (m ²)	
			47259H	47284H	47659H	ocean blue NEU
			Preisgr. A113 (m ²)	Preisgr. A150 (m ²)	Preisgr. A113 (m ²)	

Color Shade Variation: V3





Projekt: Privatpool / Standort: Neuwied, Deutschland / Architekt: Sarah Schellenberg / Serie: Kauri / Foto: Felix Krumbholz





Individuell und geheimnisvoll

Geheimnisvoller Muschelglanz, der aus den Tiefen des Meeres zu kommen scheint: Kauri fasziniert und lädt zum individuellen Planen und Gestalten ein. Die vier Mixtöne in den Formaten 1 x 1 und 2,5 x 2,5 cm zeigen den gleichen Schimmer in ihrer Oberfläche. Als eindrucksvoller Blickfang rundet das großformatige Bild „Seegras“ die Serie ab.

Mosaik 1 x 1 cm



sandbeige-mix glänzend



grau-blau-mix glänzend

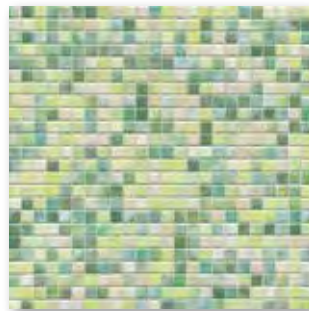

aquagrün-mix glänzend

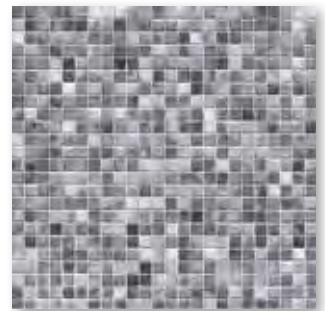

felsgrau-mix glänzend

Mosaik 2,5 x 2,5 cm



sandbeige-mix glänzend



grau-blau-mix glänzend



aquagrün-mix glänzend



felsgrau-mix glänzend

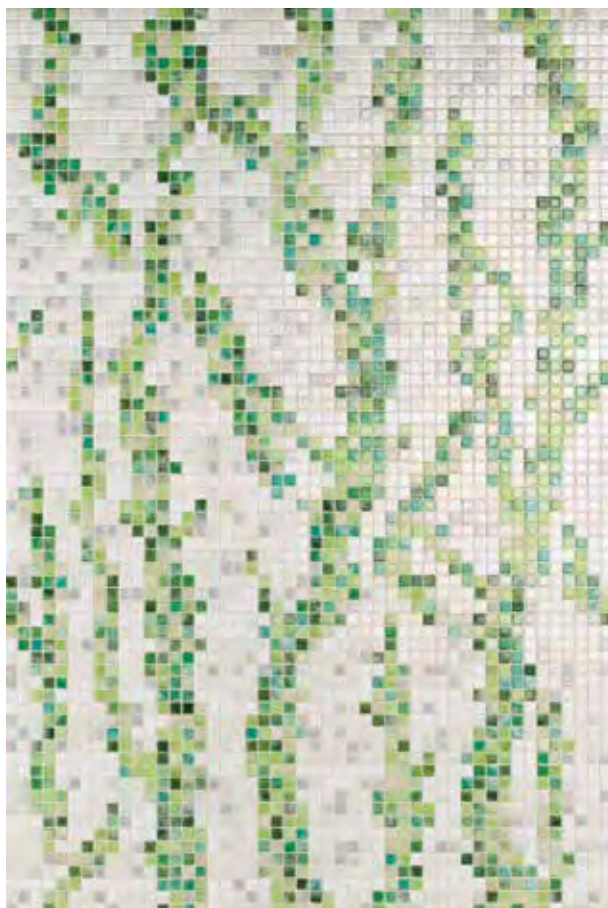

Farbverlauf 1 x 1 cm

Seegras

Herstellmaß inkl.
einer Außenfuge
632 x 948 x 6,5 mm



Mosaik, non-slip 1 x 1 cm



sandbeige-mix



grau-blau-mix



aquagrün-mix

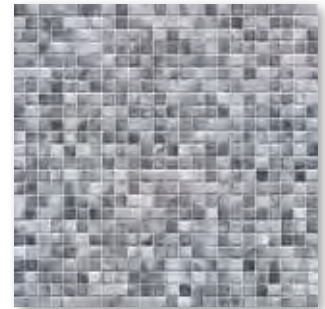

felsgrau-mix

Mosaik, non-slip 2,5 x 2,5 cm



aquagrün-mix

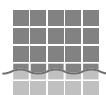

Rückseitig thermoplastisch verklebte Mosaik von AGROB BUCHTAL sind nicht nur im Trockenbereich, sondern auch bedenkenlos im Unterwasserbereich (z. B. Schwimmbecken/Whirlpool) sowie im dauernassbelasteten Bereich (z. B. Beckenumgänge/Duschen) einsetzbar.

Mosaik

1 x 1 cm¹



1 x 1 cm¹



1 x 1 cm²

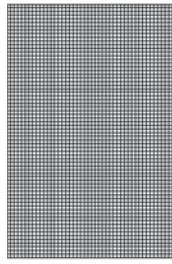

2,5 x 2,5 cm¹

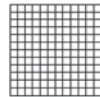

2,5 x 2,5 cm¹



Mosaik, rückseitig
thermoplastisch verklebt
Bogen: 316 x 316 mm

Mosaik, rückseitig
thermoplastisch verklebt
Bogen: 316 x 316 mm

Mosaik, rückseitig
thermoplastisch verklebt
Bogen: 297 x 297 mm

Mosaik, rückseitig
thermoplastisch verklebt
Bogen: 297 x 297 mm

Nennmaß - cm/in	1 x 1 / 3/8 x 3/8	1 x 1 / 3/8 x 3/8	1 x 1 / 3/8 x 3/8	2,5 x 2,5 / 1 x 1	2,5 x 2,5 / 1 x 1		
Herstellmaß	12 x 12 x 6,5 mm	12 x 12 x 6,5 mm	12 x 12 x 6,5 mm	23 x 23 x 6,5 mm	23 x 23 x 6,5 mm		
Oberfläche	eben, glänzend	eben, matt	eben, glänzend	eben, glänzend	eben, matt		
m ² - Stück	10 Bögen	10 Bögen	10 Bögen	11 Bögen	11 Bögen		
m ² - kg	11,930	11,930		12,100	12,100		
Paket - Stück	10 Bögen	10 Bögen	6 Bögen	11 Bögen	11 Bögen		
Paket - m ²	1,000	1,000	0,600	1,000	1,000		
Paket - kg	11,930	11,930	7,157	12,100	12,100		
Palette - m ²	24,000	24,000		48,000	48,000		
Palette - kg	286,320	286,320		580,800	580,800		
Produktnorm	Blb	Blb	Blb	Blb	Blb		
Trittsicherheit		R10/B			R10/B		
Belastung	1 - 2	1 - 2	1 - 2	1 - 2	1 - 2		
sandbeige-mix glänzend	3 8701H Preisgr. A370 (m ²)			8721H Preisgr. A256 (m ²)			
grau-blau-mix glänzend	2 8703H Preisgr. A370 (m ²)			8723H Preisgr. A256 (m ²)			
aquagrün-mix glänzend	3 8704H Preisgr. A370 (m ²)			8724H Preisgr. A256 (m ²)			
felsgrau-mix glänzend	2 8707H Preisgr. A370 (m ²)			8727H Preisgr. A256 (m ²)			
sandbeige-mix	4	8751H Preisgr. A370 (m ²)					
grau-blau-mix	3	8753H Preisgr. A370 (m ²)					
aquagrün-mix	4	8754H Preisgr. A370 (m ²)			8759H Preisgr. A283 (m ²)		
felsgrau-mix	3	8757H Preisgr. A370 (m ²)					
Seegras	3		8709 Preisgr. A791 (Set)				

¹ inkl. einer Außenfuge

² Herstellmaß inkl. einer Außenfuge
632 x 948 x 6,5 mm

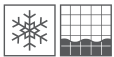



Projekt: Privatpool / Standort: Neuwied, Deutschland / Architekt: Sarah Schellenberg / Serie: Kauri / Foto: Felix Krumbholz

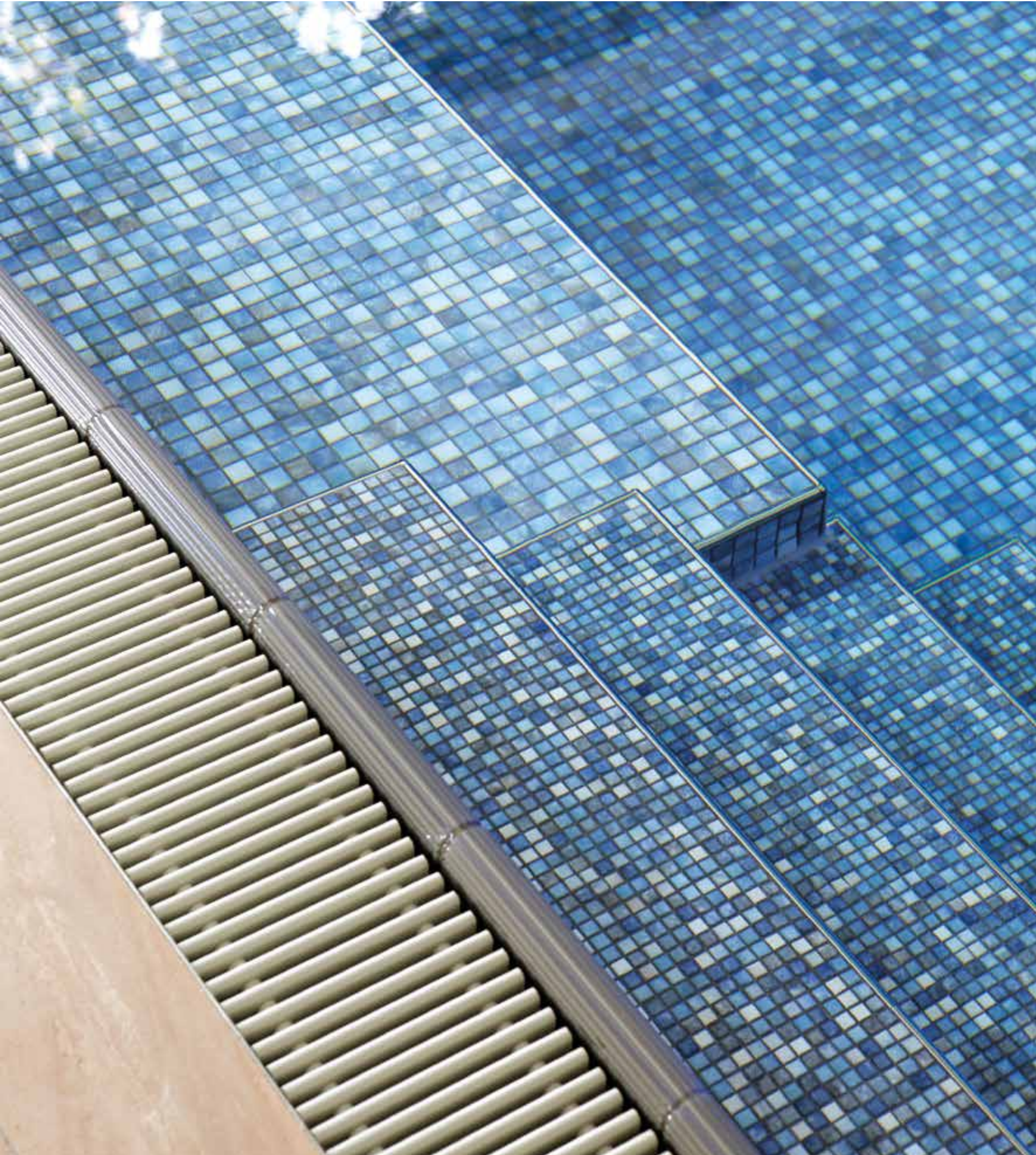

Projekt: Krankenhaus der Barmherzigen Brüder / Standort: Eisenstadt, Österreich / Architekt: Matthias Szauer / Serie: KerAion-OP-Spezialglasuren / Foto: Manfred Seidl





KerAion-OP-Spezialglasuren

Zur Wandbekleidung von Räumen, in denen mit Lasern gearbeitet wird, z.B. OP-Säle. Die Forderung nach diffus reflektierenden Oberflächen wird hervorragend erfüllt: Auftreffende Laserstrahlen werden „zerlegt“ und unkontrollierte Reflektion somit vermieden. Das Gutachten des Laser-Medizin-Zentrums Berlin bestätigt, dass folgende im medizinischen Bereich übliche Lasertypen abgedeckt werden:

- Argon – typischer sichtbarer Laser
- Nd:YAG – typischer Laser im nahen Infrarotbereich
- Excimer – typischer UV-Laser
- CO₂ – typischer Laser im mittleren Infrarotbereich

Spezifischer Vorteil im Format 60 x 60 cm: fugenarm, daher leicht zu reinigen, hygienisch. Perfekte Ergänzung für den Boden: elektrostatisch ableitende Platte ELA 10.6 (siehe Seite 143), ebenfalls im Format 60 x 60 cm.



blau



grün



grau



hellgrau



beige

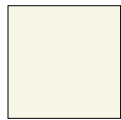

weiß

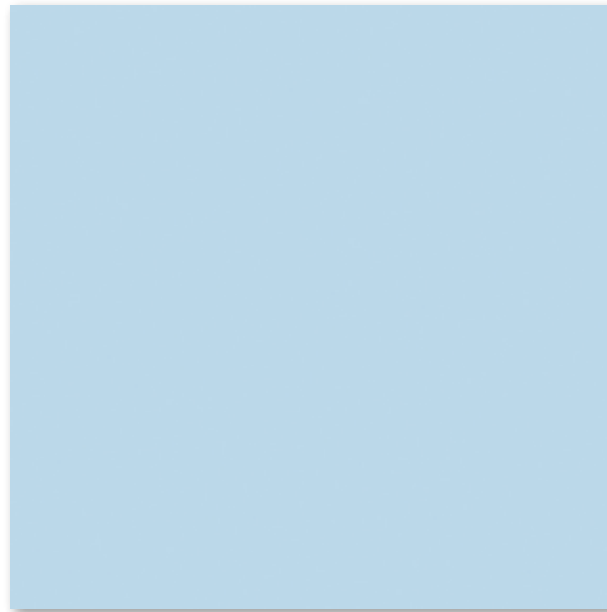
*Boden-/Wandplatten
60 x 60 cm*

Folgende Serie ist ebenfalls geeignet:

- matte Glasuren der Serien Plural (siehe Seite 234)

Im Kapitel Technische Informationen
finden Sie folgende zusätzliche
Erläuterungen zu dieser Uni-Serie:

- NCS Natural Color System
- RAL-Farbskalen
- Hellbezugswerte

Boden-/
 Wandplatten

60 x 60 cm¹

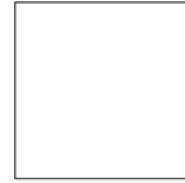

						B600HK	Formatnummer
						60 x 60 / 24 x 24	Nennmaß - cm/in
						597 x 597 x 8 mm	Herstellmaß
						eben, seidenmatt	Oberfläche
						2,780	m ² - Stück
						18,014	m ² - kg
						4	Paket - Stück
						1,439	Paket - m ²
						25,920	Paket - kg
						43,165	Palette - m ²
						777,600	Palette - kg
						Alb	Produktnorm
						2203-B600HK	4
						Preisgr. A230 (m ²)	weiß
						2204-B600HK	4
						Preisgr. A230 (m ²)	beige
						2205-B600HK	4
						Preisgr. A230 (m ²)	hellgrau
						2206-B600HK	3
						Preisgr. A230 (m ²)	grau
						2207-B600HK	3
						Preisgr. A230 (m ²)	grün
						2208-B600HK	4
						Preisgr. A230 (m ²)	blau

Die Platten der Serie KerAion-OP-Spezialglasuren sind auch in anderen Formaten
 (bis zur maximalen Kantenlänge von 120 cm) und Glasuren erhältlich.
 Bitte richten Sie bei Bedarf eine Anfrage an Ihren Kundenbetreuer.



Die geringe Fugenbreite, das Großformat und die Oberflächenveredelung Hytect
 unterstützen wirkungsvoll die leichte Reinigung und einen hohen Hygienestandard.

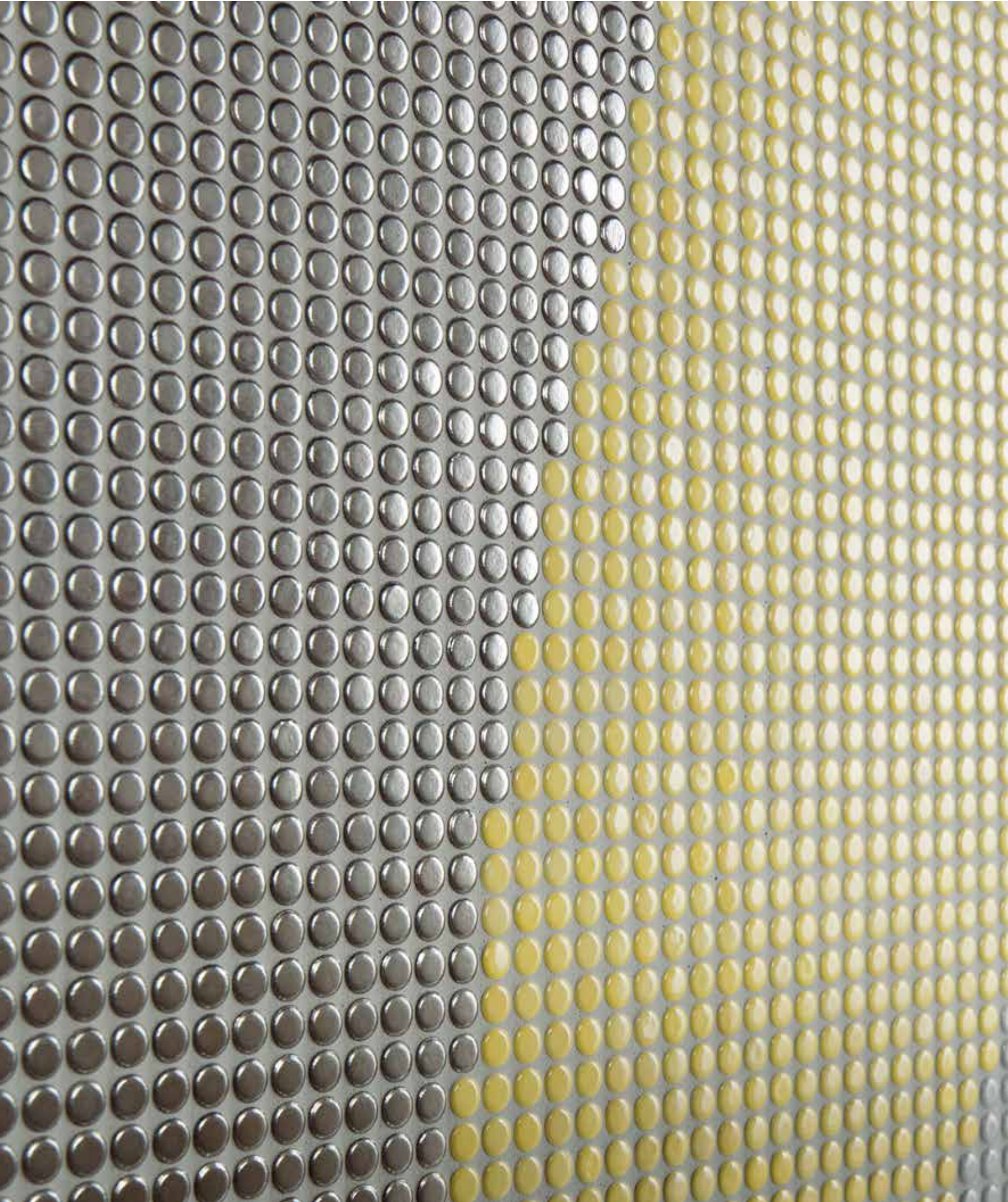



Fein und rund

Die perfekte Antwort auf den Trend zu weichen, abgerundeten Designs gibt das Mosaik LOOP. Es wird in 15 fein nuancierten, hochglänzenden Farbstellungen geliefert, von denen sechs auch in matter, rutschhemmender Ausführung erhältlich sind. So wird das Einsatzspektrum auf Duschen und andere Nassbereiche erweitert. Neben dem Mosaik mit 2 cm Durchmesser steht auch eine 1 cm Variante zur Verfügung, die besonders filigran und edel wirkt. In Kontrastfarben eignet sie sich auch für Piktogramme, Buchstaben, Pfeile und QR-Codes. Dekorelemente aus quadratischen und runden Mosaiksteinchen und das Dekor Ocean mit wellenförmig fließendem Farbverlauf runden die Serie ab.

Mosaik Ø 1 cm



arktisweiß glänzend

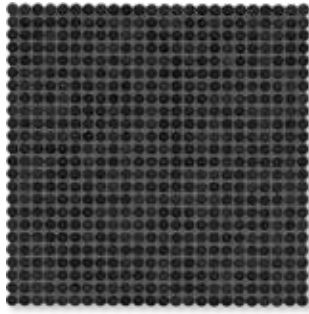

nachtschwarz glänzend



elfenbein hell glänzend



elfenbein glänzend



diamantgrau hell glänzend



diamantgrau glänzend



denim glänzend



aquablau hell glänzend

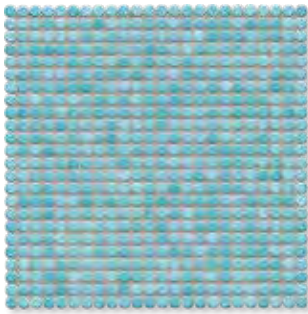

aquablau glänzend



stahlblau glänzend

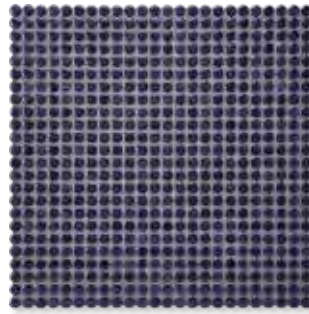

dunkelviolet glänzend

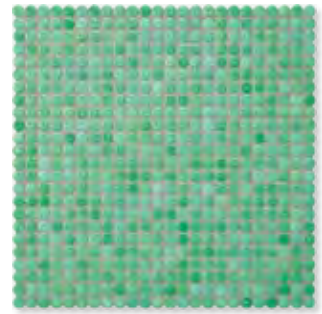

seegrün glänzend

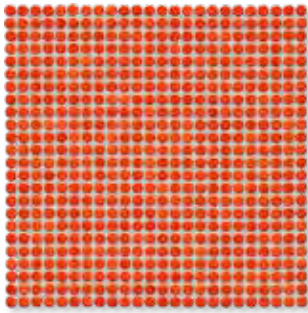

korallenrot glänzend

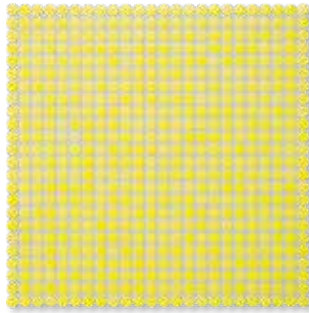

zitronengelb glänzend

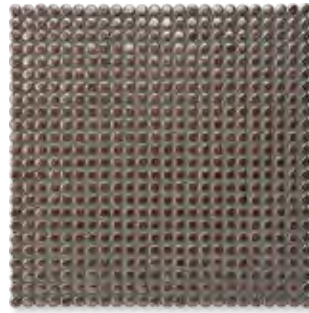

bronze-metallic

Die dargestellten Produkte können auch in anderen Farben gefertigt werden. Gerne prüfen wir die Möglichkeit einer solchen Sonderproduktion im Einzelfall.

Mosaik 1 x 1 cm / Ø 1 cm

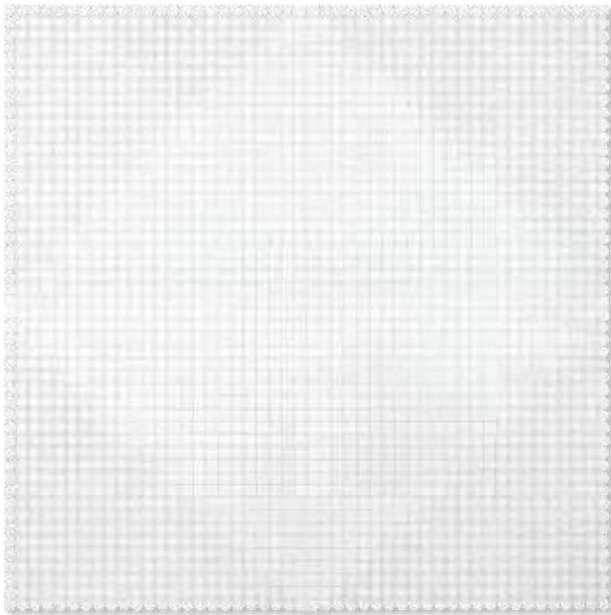

Dreieck triangle, arktisweiß glänzend



Dreieck triangle, nachtschwarz glänzend

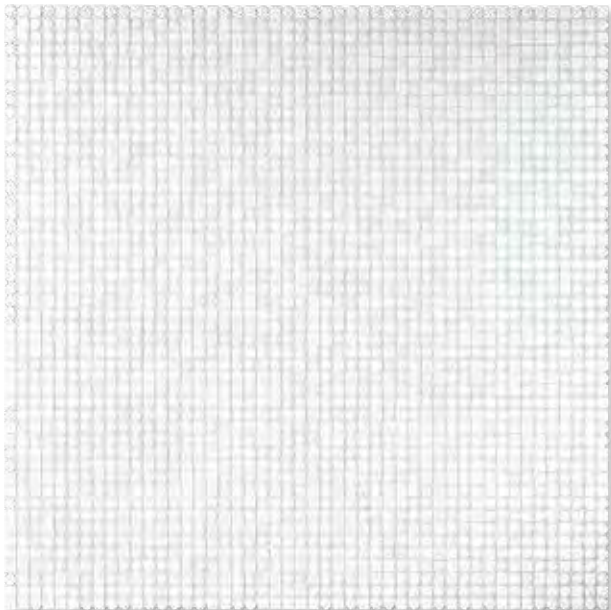

Random-Mix, arktisweiß glänzend

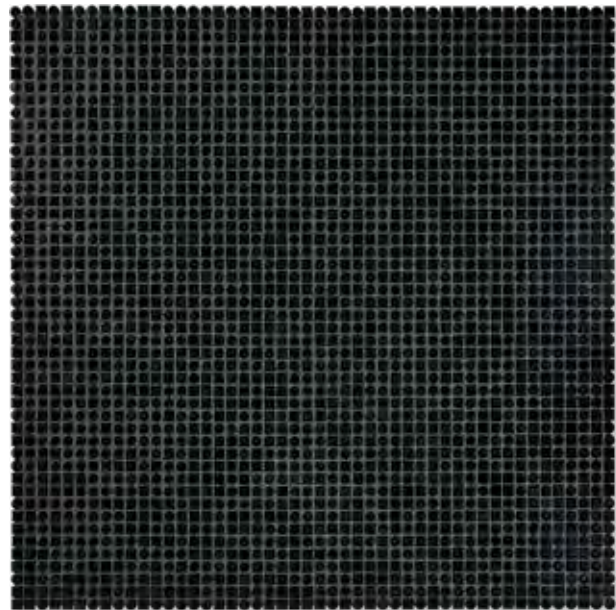

Random-Mix, nachtschwarz glänzend

Herstellmaß ohne Außenfuge 632 x 632 x 6,5 mm

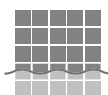

Rückseitig thermoplastisch verklebte Mosaik von AGROB BUCHTAL sind nicht nur im Trockenbereich, sondern auch bedenkenlos im Unterwasserbereich (z. B. Schwimmbecken/Whirlpool) sowie im dauernassbelasteten Bereich (z. B. Beckenumgänge/Duschen) einsetzbar.

Mosaik 1 x 1 cm / Ø 1 cm



Blätter, arktisweiß glänzend

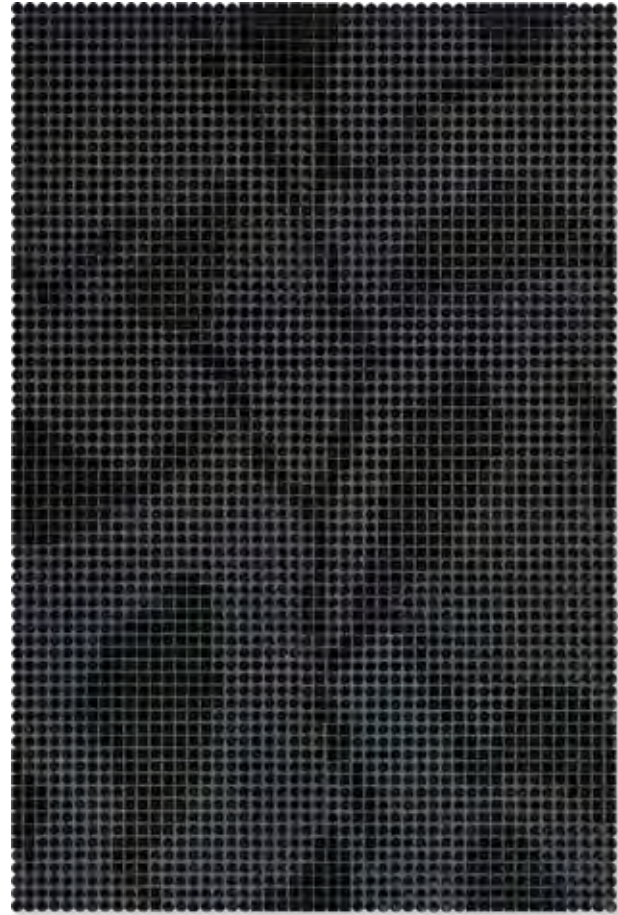

Blätter, nachtschwarz glänzend

Herstellmaß ohne Außenfuge 632 x 948 x 6,5 mm

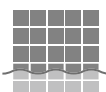

Rückseitig thermoplastisch verklebte Mosaik von AGROB BUCHTAL sind nicht nur im Trockenbereich, sondern auch bedenkenlos im Unterwasserbereich (z. B. Schwimmbecken/Whirlpool) sowie im dauernassbelasteten Bereich (z. B. Beckenumgänge/Duschen) einsetzbar.

Farbverlauf Ø 1 cm

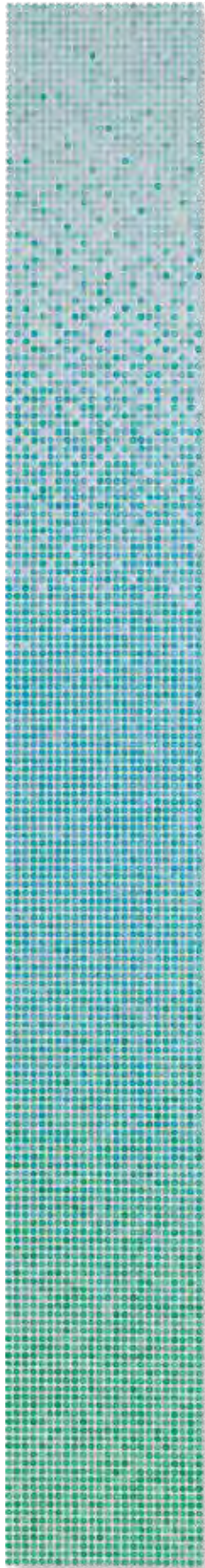

ocean glänzend

Farbverlauf Ø 2 cm



ocean glänzend

Weitere Beispiele

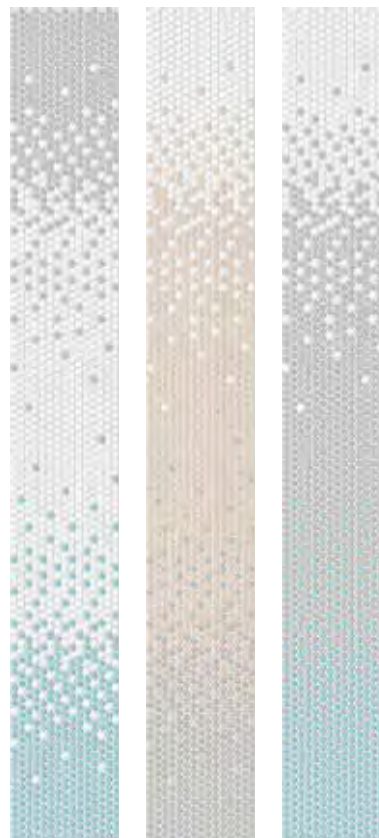
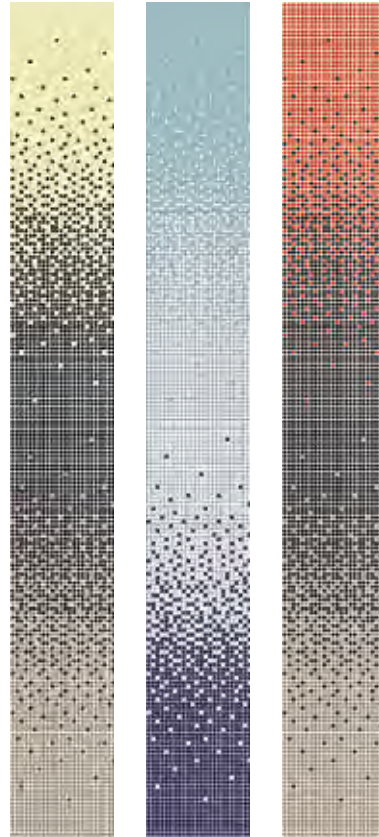

Herstellmaß ohne Außenfuge
314 x 2528 x 6,5 mm

Farbverläufe können
individuell gestaltet werden.
Gerne prüfen wir die
Möglichkeiten einer
solchen Sonderproduktion
im Einzelfall.

Mosaik Ø 2 cm



arktisweiß glänzend



nachtschwarz glänzend



elfenbein hell glänzend



elfenbein glänzend



diamantgrau hell glänzend



diamantgrau glänzend



denim glänzend



aquablau hell glänzend



aquablau glänzend

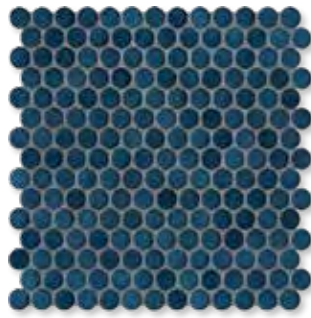

stahlblau glänzend



dunkelviolet glänzend



seegrün glänzend

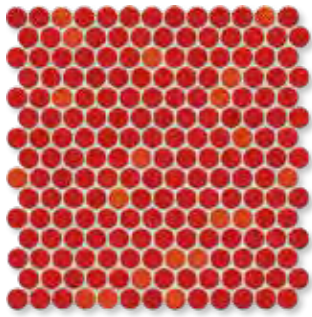

korallenrot glänzend

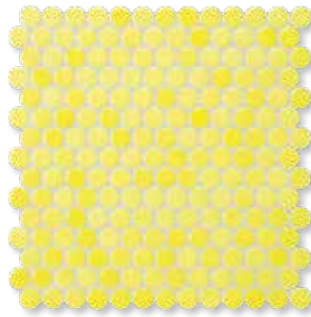

zitronengelb glänzend



bronze-metallic



R10/B



Mosaik Ø 2 cm, non-slip



arktisweiß

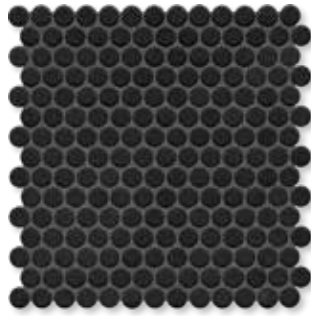

nachtschwarz



elfenbein hell



diamantgrau hell



aquablau hell

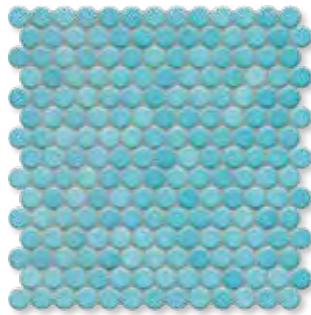

aquablau

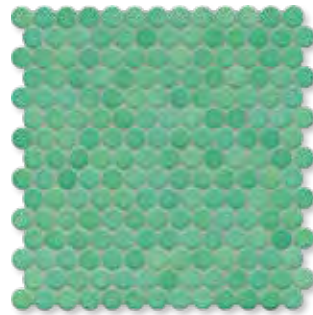

see grün

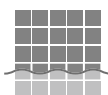

Rückseitig thermoplastisch verklebte Mosaik von AGROB BUCHTAL sind nicht nur im Trockenbereich, sondern auch bedenkenlos im Unterwasserbereich (z. B. Schwimmbecken/Whirlpool) sowie im dauernassbelasteten Bereich (z. B. Beckenumgänge/Duschen) einsetzbar.

Mosaik

Farbverlauf

Ø 1 cm

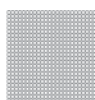

Ø 1 cm¹

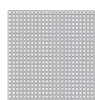

Ø 1 cm¹

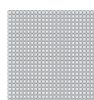

Ø 1 cm²

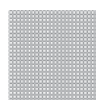

Ø 2 cm

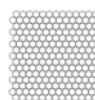

Ø 1 cm^{3/4}



Ø 2 cm⁴



Mosaik, rückseitig
thempoplastisch verklebt
Bogen: 316 x 316 mm

Mosaik, rückseitig
thempoplastisch verklebt
Bogen: 316 x 316 mm
Dreieck

Mosaik, rückseitig
thempoplastisch verklebt
Bogen: 316 x 316 mm
Random-Mix

Mosaik, rückseitig
thempoplastisch verklebt
Bogen: 316 x 316 mm
Blätter

Mosaik, rückseitig
thempoplastisch verklebt
Bogen: 326 x 316 mm

Mosaik, rückseitig
thempoplastisch verklebt
Bogen: 316 x 316 mm

Mosaik, rückseitig
thempoplastisch verklebt
Bogen: 326 x 316 mm

Nennmaß - cm/in	Ø 1 / 3/8	Ø 1 / 3/8	Ø 1 / 3/8	Ø 1 / 3/8	Ø 2 / 6/8	Ø 1 / Ø 3/8	Ø 2 / 6/8
Herstellmaß	Ø 12 x 6,5 mm	Ø 12 x 6,5 mm	Ø 12 x 6,5 mm	Ø 12 x 6,5 mm	Ø 22,3 x 6,5 mm	Ø 12 x 6,5 mm	Ø 22,3 x 6,5 mm
Oberfläche	eben, glänzend	eben, glänzend	eben, glänzend	eben, glänzend	eben, glänzend	eben, glänzend	eben, glänzend
m ² - Stück	10 Bögen	10 Bögen	10 Bögen	10 Bögen	10 Bögen	10 Bögen	10 Bögen
m ² - kg	9,720	9,720	9,720	9,720	11,600	9,720	9,720
Paket - Stück	10 Bögen	4 Bögen	4 Bögen	6 Bögen	10 Bögen	8 Bögen	8 Bögen
Paket - m ²	1,000	0,400	0,400	0,600	1,000	0,800	0,800
Paket - kg	9,720	4,320	4,320	6,480	11,600	7,776	8,872
Palette - m ²	24,000				48,000		
Palette - kg	233,280				556,800		
Produktnorm	Bib	Bib	Bib	Bib	Bib	Bib	Bib
arktisweiß	3 40000H	3 40050H	3 40052H	3 40054H	3 40020H		
glänzend	Preisgr. A377 (m ²)	Preisgr. A698 (Set)	Preisgr. A698 (Set)	Preisgr. A791 (Set)	Preisgr. A283 (m ²)		
nachtschwarz	2 40001H	2 40051H	2 40053H	2 40055H	2 40021H		
glänzend	Preisgr. A377 (m ²)	Preisgr. A698 (Set)	Preisgr. A698 (Set)	Preisgr. A791 (Set)	Preisgr. A283 (m ²)		
elfenbein hell	3 40002H				3 40022H		
glänzend	Preisgr. A377 (m ²)				Preisgr. A283 (m ²)		
elfenbein	3 40003H				3 40023H		
glänzend	Preisgr. A377 (m ²)				Preisgr. A283 (m ²)		
diamantgrau hell	3 40004H				3 40024H		
glänzend	Preisgr. A377 (m ²)				Preisgr. A283 (m ²)		
diamantgrau	2 40005H				2 40025H		
glänzend	Preisgr. A377 (m ²)				Preisgr. A283 (m ²)		
denim	3 40006H				3 40026H		
glänzend	Preisgr. A377 (m ²)				Preisgr. A283 (m ²)		
aquablau hell	3 40007H				3 40027H		
glänzend	Preisgr. A377 (m ²)				Preisgr. A283 (m ²)		
aquablau	2 40008H				2 40028H		
glänzend	Preisgr. A377 (m ²)				Preisgr. A283 (m ²)		
stahlblau	2 40009H				2 40029H		
glänzend	Preisgr. A377 (m ²)				Preisgr. A283 (m ²)		
dunkelviolet	2 40010H				2 40030H		
glänzend	Preisgr. A377 (m ²)				Preisgr. A283 (m ²)		
seegrün	3 40011H				3 40031H		
glänzend	Preisgr. A377 (m ²)				Preisgr. A283 (m ²)		
korallenrot	2 40012H				2 40032H		
glänzend	Preisgr. A377 (m ²)				Preisgr. A283 (m ²)		
zitronengelb	3 40013H				3 40033H		
glänzend	Preisgr. A377 (m ²)				Preisgr. A283 (m ²)		
bronze-metallic	1 40014 ⁵				1 40034 ⁵		
	Preisgr. A381 (m ²)				Preisgr. A326 (m ²)		
ocean	2				2 40056H	2 40057H	
glänzend					Preisgr. A791 (St.)	Preisgr. A750 (St.)	



¹ Herstellmaß ohne Außenfuge: 632 x 632 x 6,5 mm

² Herstellmaß ohne Außenfuge: 632 x 948 x 6,5 mm

³ Herstellmaß ohne Außenfuge: 314 x 2528 x 6,5 mm

⁴ Preisangabe bezieht sich auf den Farbverlauf = 8 Bögen

⁵ Nicht oder nur bedingt säure- und laugenbeständig.

Farbverläufe können individuell gestaltet werden. Gerne prüfen wir die Möglichkeit einer solchen Sonderproduktion im Einzelfall.

Mosaik non-slip

Ø 2 cm



Mosaik, rückseitig
thermoplastisch verklebt
Bogen: 326 x 316 mm



						Ø 2 / 6/8		
						Ø 22,3 x 6,5 mm		
						eben, matt		
						10 Bögen		
						11,600		
						10 Bögen		
						1,000		
						11,600		
						48,000		
						556,800		
						Blb		
						R10/B		
						40040H	4	
						Preisgr. A296 (m ²)		arktischweiß
						40041H	2	
						Preisgr. A296 (m ²)		nachtschwarz
						40042H	4	
						Preisgr. A296 (m ²)		elfenbein hell
						40044H	4	
						Preisgr. A296 (m ²)		diamantgrau hell
						40047H	4	
						Preisgr. A296 (m ²)		aquablau hell
						40048H	3	
						Preisgr. A296 (m ²)		aquablau
						40071H	3	
						Preisgr. A296 (m ²)		seegrün

Die dargestellten Produkte können auch in anderen Farben gefertigt werden. Gerne prüfen wir die Möglichkeit einer solchen Sonderproduktion im Einzelfall.

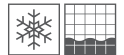



3D-Rendering / Serie: Marble & More





Detailreiche Möglichkeiten

Während Marmor in der Regel in großen Formaten eingesetzt wird, besticht die Marble & More Mosaikserie mit ihrer fast schon kleinteiligen Ästhetik und ihrer vielfältigen Farbigkeit. Anders als ihr natürliches Marmor-Vorbild ist diese Fliese unempfindlich gegen aggressive Medien wie Reinigungsmittel, Shampoos und Seifen. Trittsichere Varianten erweitern die verlegerischen Freiheiten von Planern und Architekten. Als Hytect Fliesen sind Marble & More sehr pflegeleicht und sie sorgen für Hygiene. Zudem ist die Serie an Boden und Wand farblich auf die Serie Ascona abgestimmt.

Mosaik 1 x 1 cm



carrara white, eben



illusion beige, eben

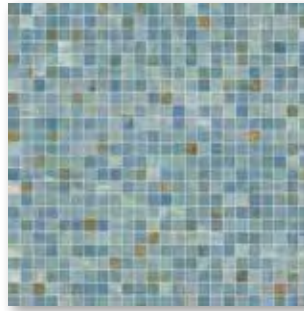

cielo, eben

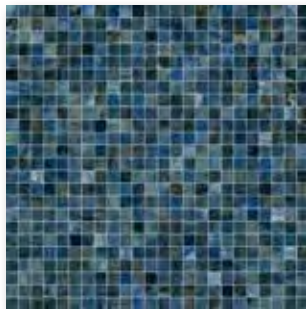

labradorit blue, eben

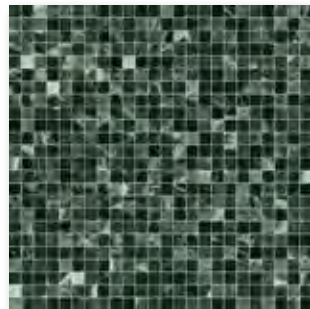

verde alpi, eben

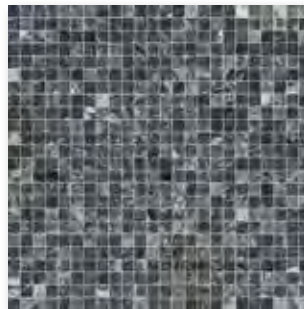

illusion dark, eben

Mosaik 2,5 x 2,5 cm



carrara white, eben
carrara white, eben, trittsicher R10/B



illusion beige, eben
illusion beige, eben, trittsicher R10/B

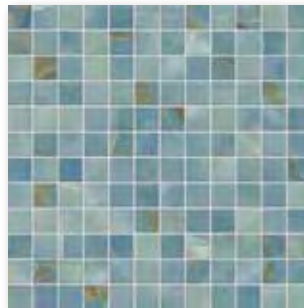

cielo, eben
cielo, eben, trittsicher R10/B



labradorit blue, eben
labradorit blue, eben, trittsicher R10/B



verde alpi, eben
verde alpi, eben, trittsicher R10/B



illusion dark, eben
illusion dark, eben, trittsicher R10/B

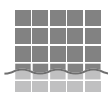

Rückseitig thermoplastisch verklebte Mosaik von AGROB BUCHTAL sind nicht nur im Trockenbereich, sondern auch bedenkenlos im Unterwasserbereich (z. B. Schwimmbecken/Whirlpool) sowie im dauernassbelasteten Bereich (z. B. Beckenumgänge/Duschen) einsetzbar.

Mosaik

1 x 1 cm



Mosaik, rückseitig thermoplastisch verklebt
Bogen: 297 x 297 mm

2,5 x 2,5 cm



Mosaik, rückseitig thermoplastisch verklebt
Bogen: 297 x 297 mm



				1 x 1 / 3/8 x 3/8	2,5 x 2,5 / 1 x 1	Beanspruchungsgruppe	Nennmaß
				12 x 12 x 6,5 mm eben, glänzend	23 x 23 x 6,5 mm eben, glänzend		Herstellmaß
				10,000	11,000		Oberfläche
				11,930	12,100		m ² - Stück
				10	11		m ² - kg
				1,000	1,000		Paket - Stück
				11,930	12,100		Paket - m ²
				24,000	48,000		Paket - kg
				286,320	580,800		Palette - m ²
				Bib	Bib		Palette - kg
							Produktnorm
				1 - 2	1 - 2		Trittsicherheit
							Belastung
				431123H	431117H	3	carrara white
				Preisgr. A370 (m ²)	Preisgr. A205 (m ²)		
				431124H	431118H	3	illusion beige
				Preisgr. A370 (m ²)	Preisgr. A205 (m ²)		
				431125H	431119H	3	cielo
				Preisgr. A370 (m ²)	Preisgr. A205 (m ²)		
				431126H	431120H	2	labradorit blue
				Preisgr. A370 (m ²)	Preisgr. A205 (m ²)		
				431127H	431121H	2	verde alpi
				Preisgr. A370 (m ²)	Preisgr. A205 (m ²)		
				431128H	431122H	2	illusion dark
				Preisgr. A370 (m ²)	Preisgr. A205 (m ²)		



Mosaik

2,5 x 2,5 cm



Mosaik, rückseitig thermoplastisch verklebt
Bogen: 297 x 297 mm



				2,5 x 2,5 / 1 x 1	23 x 23 x 6,5 mm	Beanspruchungsgruppe	Nennmaß
				eben, matt	eben, matt		Herstellmaß
				11,000	11,000		Oberfläche
				12,100	12,100		m ² - Stück
				11	11		m ² - kg
				1,000	1,000		Paket - Stück
				12,100	12,100		Paket - m ²
				48,000	48,000		Paket - kg
				580,800	580,800		Palette - m ²
				Bib	Bib		Palette - kg
				R10/B	R10/B		Produktnorm
				1 - 2	1 - 2		Trittsicherheit
							Belastung
				431111H	431111H	4	carrara white
				Preisgr. A216 (m ²)	Preisgr. A216 (m ²)		
				431112H	431112H	4	illusion beige
				Preisgr. A216 (m ²)	Preisgr. A216 (m ²)		
				431113H	431113H	4	cielo
				Preisgr. A216 (m ²)	Preisgr. A216 (m ²)		
				431114H	431114H	3	labradorit blue
				Preisgr. A216 (m ²)	Preisgr. A216 (m ²)		
				431115H	431115H	2	verde alpi
				Preisgr. A216 (m ²)	Preisgr. A216 (m ²)		
				431116H	431116H	4	illusion dark
				Preisgr. A216 (m ²)	Preisgr. A216 (m ²)		



Projekt: Hauptbahnhof / Standort: Lübeck, Deutschland / Architekt: GÖSSLER KINZ KREIENBAUM Architekten BDA / Serie: Naturkeramik / Foto: Daniel Sumesgutner





Jede Fliese ein Unikat

Naturkeramik verbindet kreative Vielfalt und handwerkliche Tradition in einem authentischen keramischen Produkt. Und da das Material garantiert frostsicher ist, lässt sich eine einheitliche, harmonische Bodengestaltung von Innen- und Außenbereich realisieren. Das einzigartige Farbspiel in warmen Erdtönen bietet viel Behaglichkeit bei maximaler Gestaltungsfreiheit. Formteile für Treppen und Brüstungen unterstützen die handwerklich perfekte Ausführung anspruchsvoller Raumkonzepte.



R11/A R11/B



goldocker



goldcreme



goldgrau



goldschwarz



herbstlaub



naturrot



portofino



braunpalette



ziegelrot

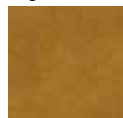

tabak



Boden-/Wandplatte 15 x 15 cm



Boden-/Wandplatte 12,5 x 25 cm



Boden-/Wandplatte 15 x 30 cm



Boden-/Wandplatte 25 x 25 cm



Treppenplatte (rilliert)
25 x 30 cm



Sockel, gerundet 8,3 x 30 cm



Sockel, gerundet 8,3 x 25 cm



Schenkelplatte 12,5 x 30 cm



*Schenkelplatte
12,5 x 25 cm*



*Florentiner
Stufenplatte
25 x 35 cm*



*Florentiner
Eckstück
35 x 35 cm*



*Florentiner
Sockel rechts
oder links*



*Florentiner Piccolo
12,5 x 25 cm*



Eckstück geklebt 7,3 x 24 cm / 11,5 x 11 cm

Boden-/Wandplatten¹

12,5 x 25 cm



25 x 25 cm



15 x 15 cm



15 x 30 cm



12,5 x 25 cm



25 x 25 cm



Formatnummer	1010	1630	1030	1020	1100	1620	
Nennmaß - cm/in	12,5 x 25 / 5 x 10	25 x 25 / 10 x 10	15 x 15 / 6 x 6	15 x 30 / 6 x 12	12,5 x 25 / 5 x 10	25 x 25 / 10 x 10	
Herstellmaß	115 x 240 x 10 mm	240 x 240 x 10 mm	140 x 140 x 11 mm	140 x 290 x 11 mm	115 x 240 x 11 mm	240 x 240 x 11 mm	
Oberfläche	eben, matt ²	eben, matt ²	gehämmert, matt	gehämmert, matt	eben, seidenglänzend	eben, seidenglänzend	
m ² - Stück	33,000	16,000	44,440	22,220	33,000	16,000	
m ² - kg	19,800	20,160	19,642	21,442	21,450	23,680	
Paket - Stück	26	13	24	18	24	12	
Paket - m ²	0,788	0,813	0,540	0,810	0,727	0,750	
Paket - kg	15,600	16,380	10,608	17,370	15,600	17,760	
Palette - m ²	56,727	51,188	45,905	37,264	52,364	47,250	
Palette - kg	1.123,200	1.031,940	901,680	799,020	1.123,200	1.118,880	
Produktnorm	Alla	Alla	Alla	Alla	Alla	Alla	
Trittsicherheit	siehe unten	siehe unten	R11/A	R11/A			
Belastung	2	2	2	2			
goldocker	R11/A 851-1010 Preisgr. A67 (m ²)	R11/A 851-1630 Preisgr. A94 (m ²)	851-1030 Preisgr. A101 (m ²)	851-1020 Preisgr. A94 (m ²)			
goldcreme	R11/A 854-1010 Preisgr. A67 (m ²)	R11/A 854-1630 Preisgr. A94 (m ²)	854-1030 Preisgr. A101 (m ²)	854-1020 Preisgr. A94 (m ²)			
goldgrau	R11/A 855-1010 Preisgr. A67 (m ²)	R11/A 855-1630 Preisgr. A94 (m ²)	855-1030 Preisgr. A101 (m ²)	855-1020 Preisgr. A94 (m ²)			
goldschwarz	R11/A 856-1010 Preisgr. A67 (m ²)	R11/A 856-1630 Preisgr. A94 (m ²)	856-1030 Preisgr. A101 (m ²)	856-1020 Preisgr. A94 (m ²)			
herbstlaub	R11/B 0105-1010 Preisgr. A67 (m ²)	R11/B 0105-1630 Preisgr. A94 (m ²)					
naturrot	R11/B 0705-1010 Preisgr. A67 (m ²)	R11/B 0705-1630 Preisgr. A94 (m ²)					
portofino	R11/A 948-1010 Preisgr. A67 (m ²)	R11/A 948-1630 Preisgr. A94 (m ²)					
braunpalette	R11/B 950-1010 Preisgr. A61 (m ²)	R11/B 950-1630 Preisgr. A81 (m ²)					
ziegelrot	R11/A 958-1010 Preisgr. A61 (m ²)	R11/A 958-1630 Preisgr. A81 (m ²)					
tabak	3				951-1100 Preisgr. A67 (m ²)	951-1620 Preisgr. A94 (m ²)	



- ¹ Color Shade Variation
- V1: naturrot, ziegelrot
- V2: goldcreme, goldgrau, goldschwarz
- V3: herbstlaub
- V4: goldocker, portofino, braunpalette, tabak

² Ausnahmen: goldocker, goldcreme, goldgrau, goldschwarz: gehämmert, matt

Hinweis: Oberfläche mit einer geeigneten Imprägnierung behandeln! Siehe technische Informationen S. 474.

Sockelleisten, gerundet¹

Schenkelplatten¹

Treppensystem¹

8,3 x 25 cm

8,3 x 30 cm

12,5 x 25 cm

12,5 x 30 cm

25 x 30 cm

25 x 30 cm

25 x 30 cm

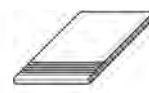
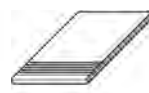
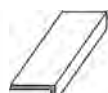

9066		9063		4822		4825		Treppenplatte	Ecke links	Ecke rechts	Beanspruchungsgruppe
8,3 x 25 / 33/8 x 10	8,3 x 30 / 33/8 x 12	12,5 x 25 / 5 x 10	12,5 x 30 / 5 x 12	25 x 30 / 10 x 12	25 x 30 / 10 x 12	25 x 30 / 10 x 12	25 x 30 / 10 x 12	9570	9573	9574	
73 x 240 x 11 mm	73 x 290 x 11 mm	115/52 x 240 x 11 mm	115/52 x 290 x 11 mm	240 x 300 x 14 mm	240 x 300 x 14 mm	240 x 300 x 14 mm	240 x 300 x 14 mm	240 x 300 x 14 mm	240 x 300 x 14 mm	240 x 300 x 14 mm	
eben, matt ²	gehämmert, matt	eben, matt ²	gehämmert, matt	eben, matt ²	eben, matt ²	eben, matt ²	eben, matt ²	eben, matt ²	eben, matt ²	eben, matt ²	
4,000	3,333	4,000	3,333	4,000	3,333	4,000	3,333	4,000	3,333	4,000	
1,600/m	1,600/m	3,880/m	3,903/m	8,600/m	8,600/m	8,600/m	8,600/m	2,100/Stück	2,100/Stück	2,100/Stück	
22	22	8	8	8	8	8	8	8	8	8	
5,500	6,601	2,000	2,400	2,000	2,400	2,000	2,400	16,800	16,800	16,800	
8,800	10,560	7,760	9,368	17,200	17,200	17,200	17,200	16,800	16,800	16,800	
Alla	Alla	Alla	Alla	Alla	Alla	Alla	Alla	Alla	Alla	Alla	
		siehe unten	R11/A	siehe unten	siehe unten	siehe unten	siehe unten				
851-9066	851-9063	851-4822	851-4825								Formatnummer
Preisgr. A410 (St.)	Preisgr. A416 (St.)	Preisgr. A426 (St.)	Preisgr. A449 (St.)								Nennmaß - cm/in
		R11/A									Herstellmaß
854-9066	854-9063	854-4822	854-4825								Oberfläche
Preisgr. A410 (St.)	Preisgr. A416 (St.)	Preisgr. A426 (St.)	Preisgr. A449 (St.)								m - Stück
		R11/A									m/St. - kg
855-9066	855-9063	855-4822	855-4825								Paket - Stück
Preisgr. A410 (St.)	Preisgr. A416 (St.)	Preisgr. A426 (St.)	Preisgr. A449 (St.)								Paket - m
		R11/A									Paket - kg
856-9066	856-9063	856-4822	856-4825								Palette - m
Preisgr. A410 (St.)	Preisgr. A416 (St.)	Preisgr. A426 (St.)	Preisgr. A449 (St.)								Palette - kg
		R11/A									Produktnorm
0105-9066		0105-4822		R11/B	R11/B	R11/B	R11/B				Trittsicherheit
Preisgr. A410 (St.)		Preisgr. A426 (St.)		0105-9570	0105-9573	0105-9574	0105-9574				
		R11/B		Preisgr. A458 (St.)	Preisgr. A487 (St.)	Preisgr. A487 (St.)	Preisgr. A487 (St.)				golddoker
0705-9066		0705-4822		R11/B	R11/B	R11/B	R11/B				
Preisgr. A410 (St.)		Preisgr. A426 (St.)		0705-9570	0705-9573	0705-9574	0705-9574				goldcreme
		R11/A		Preisgr. A458 (St.)	Preisgr. A487 (St.)	Preisgr. A487 (St.)	Preisgr. A487 (St.)				
948-9066		948-4822		R11/A	R11/A	R11/A	R11/A				goldgrau
Preisgr. A410 (St.)		Preisgr. A426 (St.)		948-9570	948-9573	948-9574	948-9574				
		R11/B		Preisgr. A458 (St.)	Preisgr. A487 (St.)	Preisgr. A487 (St.)	Preisgr. A487 (St.)				goldschwarz
950-9066		950-4822									
Preisgr. A410 (St.)		Preisgr. A426 (St.)									herbstlaub
		R11/A									
958-9066		958-4822									
Preisgr. A410 (St.)		Preisgr. A426 (St.)									naturrot
		R11/A									
951-9066		951-4822									
Preisgr. A410 (St.)		Preisgr. A426 (St.)									portofino
		R11/A									
											braunpalette
											ziegelrot
											3
											tabak

¹ Color Shade Variation

- V1: naturrot, ziegelrot
- V2: goldcreme, goldgrau, goldschwarz
- V3: herbstlaub
- V4: golddoker, portofino, braunpalette, tabak

² Ausnahmen: golddoker, goldcreme, goldgrau, goldschwarz: gehämmert, matt, tabak: eben, seidenglänzend

Aus produktionstechnischen Gründen können leichte Farb- / Größenunterschiede zur Flächenware nicht ausgeschlossen werden.

Hinweis: Oberfläche mit einer geeigneten Imprägnierung behandeln! Siehe Kapitel Technische Informationen S. 474



Florentiner Stufensystem³

25 x 35 cm

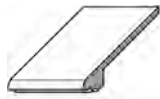

35 x 35 cm

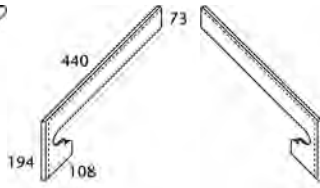
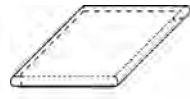

Florentiner Piccolo³

12,5 x 25 cm



Eckstück³

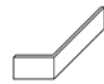

	Stufenplatte	Eckstück (links/rechts verwendbar)	Sockel links ¹	Sockel rechts ¹		Eckstück geklebt
Formatnummer	9330	9335	9337	9338	9822	2541
Nennmaß - cm/in	25 x 35 / 10 x 14	35 x 35 / 14 x 14			12,5 x 25 / 5 x 10	
Herstellmaß mm	240 x 350 x 42/14	350 x 350 x 42/14	440/73 x 194/108 x 11	440/73 x 194/108 x 11	115/52 x 240 x 11	73 x 240/115 x 11
Oberfläche	eben, matt ²	eben, matt ²	eben, matt ²	eben, matt ²	gehämmert, matt	gehämmert, matt
m - Stück	4,000				4,000	
m/St. - kg	11,600/m	4,900/Stück	0,900/Stück	0,900/Stück	3,900/m	0,600/Stück
Paket - Stück	6	1	4	4	8	18
Paket - m	1,500				2,000	
Paket - kg	17,400	4,900	3,600	3,600	7,800	10,800
Palette - m						
Palette - kg						
Produktnorm	Alla	Alla	Alla	Alla	Alla	
Trittsicherheit	siehe unten	siehe unten			R11/A	
	R11/A	R11/A				
goldocker	851-9330 Preisgr. A467 (St.)	851-9335 Preisgr. A601 (St.)	851-9337 Preisgr. A484 (St.)	851-9338 Preisgr. A484 (St.)	851-9822 Preisgr. A441 (St.)	851-2541 Preisgr. A441 (St.)
goldcreme	854-9330² Preisgr. A467 (St.)	854-9335 Preisgr. A601 (St.)	854-9337 Preisgr. A484 (St.)	854-9338 Preisgr. A484 (St.)	854-9822 Preisgr. A441 (St.)	854-2541 Preisgr. A441 (St.)
goldgrau	855-9330 Preisgr. A467 (St.)	855-9335 Preisgr. A601 (St.)	855-9337 Preisgr. A484 (St.)	855-9338 Preisgr. A484 (St.)	855-9822 Preisgr. A441 (St.)	855-2541 Preisgr. A441 (St.)
goldschwarz	856-9330 Preisgr. A467 (St.)	856-9335 Preisgr. A601 (St.)	856-9337 Preisgr. A484 (St.)	856-9338 Preisgr. A484 (St.)	856-9822 Preisgr. A441 (St.)	856-2541 Preisgr. A441 (St.)
herbstlaub	010S-9330 Preisgr. A467 (St.)	010S-9335 Preisgr. A601 (St.)	010S-9337 Preisgr. A484 (St.)	010S-9338 Preisgr. A484 (St.)		
naturrot	070S-9330 Preisgr. A467 (St.)	070S-9335 Preisgr. A601 (St.)	070S-9337 Preisgr. A484 (St.)	070S-9338 Preisgr. A484 (St.)		
portofino	948-9330 Preisgr. A467 (St.)	948-9335 Preisgr. A601 (St.)	948-9337 Preisgr. A484 (St.)	948-9338 Preisgr. A484 (St.)		
ziegelrot	958-9330 Preisgr. A467 (St.)	958-9335 Preisgr. A601 (St.)	958-9337 Preisgr. A484 (St.)	958-9338 Preisgr. A484 (St.)		



¹ Verlängerung der Sockel 9337/9338 mit Formatnummer 9066 (240 x 73 x 11 mm) oder Formatnummer 9063 (290 x 73 x 11 mm).

² Ausnahmen: goldocker, goldcreme, goldgrau, goldschwarz: gehämmert, matt

³ Color Shade Variation

V1: naturrot, ziegelrot

V2: goldcreme, goldgrau, goldschwarz

V3: herbstlaub

V4: goldocker, portofino, braunpalette, tabak

Aus produktionstechnischen Gründen können leichte Farb-/Größenunterschiede zur Flächenware nicht ausgeschlossen werden.

Hinweis: Oberfläche mit einer geeigneten Imprägnierung behandeln! Siehe technische Informationen Seite 474.

Studioaufnahme / Serie: Naturkeramik





Härtetest: Jedem Druck gewachsen

Böden in Supermärkten sollen ansprechend, pflegeleicht und enorm belastbar sein. Diese Ansprüche erfüllt Agrob Buchtal mit überstarken Fliesen und Platten in Dicken bis zu 20 mm. Mit Bruchfestigkeitswerten, die erheblich über den einschlägigen Normen liegen, halten die rektifizierten Großformate auch das Befahren mit Gabelstaplern und Hubwagen ohne Probleme aus. Dabei verbindet sich extreme Robustheit mit attraktiver Optik: Feinsteinzeug-Oberflächen in vielen Farbstellungen bieten alle Voraussetzungen für eine repräsentative Gestaltung. Und für wirksamen Fleckenschutz bürgt die bewährte Protecta-Vergütung.



Design Emotion

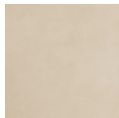

hellbeige



tiefanthrazit

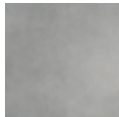

mittelgrau

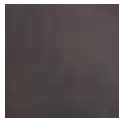

bronze

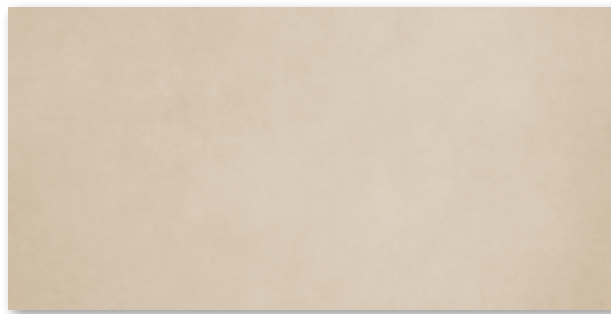

Bodenfliese 30 x 60 cm, überstark

Design Inside-Out



anthrazit



graubraun



zementgrau

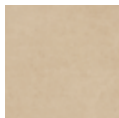

sand



Bodenfliese 30 x 30 cm, überstark



Bodenfliese 30 x 60 cm, überstark

 Das Format 30 x 60 cm wird konisch rektifiziert.

Design Mandalay



weißgrau

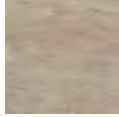

hellbraun



rauchbraun



schwarzbraun



Bodenfliese 30 x 60 cm, überstark

Design Xeno



anthrazit

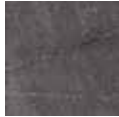

schwarz



Bodenfliese 30 x 60 cm, überstark

 Das Format 30 x 60 cm wird konisch rektifiziert.

Bodenfliesen

30 x 30 cm²



30 x 30 cm²



30 x 60 cm^{1/2}



30 x 60 cm^{1/2}



30 x 60 cm^{1/2}



30 x 60 cm^{1/2}



30 x 60 cm^{1/2}



protected

	<i>Design Inside-Out</i>	<i>Design Inside-Out</i>	<i>Design Emotion</i>	<i>Design Emotion</i>	<i>Design Inside-Out</i>	<i>Design Inside-Out</i>	<i>Design Mandalay</i>
Nennmaß - cm/in	30 x 30 / 12 x 12	30 x 30 / 12 x 12	30 x 60 / 12 x 24	30 x 60 / 12 x 24	30 x 60 / 12 x 24	30 x 60 / 12 x 24	30 x 60 / 12 x 24
Herstellmaß	297 x 297 x 15 mm	297 x 297 x 15 mm	297 x 597 x 15 mm	297 x 597 x 15 mm	297 x 597 x 15 mm	297 x 597 x 15 mm	297 x 597 x 15 mm
Oberfläche	eben, matt	eben, matt	eben, matt	strukturiert, matt	eben, matt	eben, matt	strukturiert, matt
m ² - Stück	11,337	11,337	5,589	5,589	5,589	5,589	5,589
m ² - kg	34,317	34,317	34,456	34,456	34,456	34,456	34,456
Paket - Stück	7	7	4	4	4	4	4
Paket - m ²	0,617	0,617	0,716	0,716	0,716	0,716	0,716
Paket - kg	21,189	21,189	24,660	24,660	24,660	24,660	24,660
Palette - m ²	29,637	29,637	28,628	28,628	28,628	28,628	28,628
Palette - kg	1.017,072	1.017,072	968,400	986,400	986,400	986,400	986,400
Produktnorm	Bla	Bla	Bla	Bla	Bla	Bla	Bla
Trittsicherheit	R9	R10	R9	R10/A	R9	R10	R9
Belastung	3 - 4	3 - 4	3 - 4	3 - 4	3 - 4	3 - 4	3 - 4
graubraun	433653 Preisgr. A150 (m ²)	433764 Preisgr. A150 (m ²)			433621 Preisgr. A177 (m ²)	433760 Preisgr. A177 (m ²)	
zementgrau	433654 Preisgr. A150 (m ²)	433765 Preisgr. A150 (m ²)			433622 Preisgr. A177 (m ²)	433761 Preisgr. A177 (m ²)	
sand	433655 Preisgr. A150 (m ²)	433766 Preisgr. A150 (m ²)			433623 Preisgr. A177 (m ²)	433762 Preisgr. A177 (m ²)	
anthrazit	433656 Preisgr. A150 (m ²)	433767 Preisgr. A150 (m ²)			433624 Preisgr. A177 (m ²)	433763 Preisgr. A177 (m ²)	
tiefanthrazit			433413 Preisgr. A177 (m ²)	433416 Preisgr. A177 (m ²)			
mittelgrau			433414 Preisgr. A177 (m ²)	433417 Preisgr. A177 (m ²)			
hellbeige			433415 Preisgr. A177 (m ²)	433418 Preisgr. A177 (m ²)			
weißgrau							434482 Preisgr. A177 (m ²)
hellbraun							434483 Preisgr. A177 (m ²)
rauchbraun							434484 Preisgr. A177 (m ²)
schwarzbraun							434485 Preisgr. A177 (m ²)



1



konisch rektifiziert

2



Auftragsfertigung: Rückgabe und/oder Stornierung bestellter Ware nicht möglich.

Bodenfliesen

30 x 60 cm^{1/2}



protected

Design Xeno

						30 x 60 / 12 x 24	Nennmaß - cm/in
						297 x 597 x 15 mm	Herstellmaß
						eben, matt	Oberfläche
						5,589	m ² - Stück
						34,456	m ² - kg
						4	Paket - Stück
						0,716	Paket - m ²
						24,660	Paket - kg
						28,628	Palette - m ²
						986,400	Palette - kg
						Bla	Produktnorm
						R10/A	Trittsicherheit
						3 - 4	Belastung
						432658	
						Preisgr. A177 (m ²)	anthrazit
						432659	
						Preisgr. A177 (m ²)	schwarz

¹ konisch rektifiziert

² Auftragsfertigung: Rückgabe und/oder Stornierung
bestellter Ware nicht möglich.







Lebendig und vielfältig

Durch ihren modularen Aufbau in Farben und Formaten ermöglicht die trittsichere Feinsteinzeugserie Nova individuelle Lösungen in unterschiedlichsten Einsatzbereichen. Die von Terrazzoböden inspirierte Optik umfasst sechs fein abgestimmte Farbnuancen von cremebeige über mittelgrau bis hin zu anthrazit bunt.



cremebeige



mittelbraun



mittelgrau

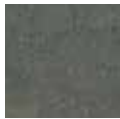

basalt



anthrazit



anthrazit bunt



Bodenfliese 15 x 15 cm

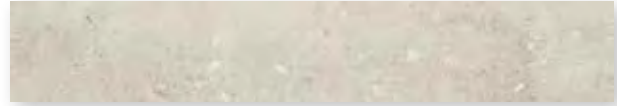

Riegelformat 10 x 60 cm



Riegelformat 15 x 60 cm



Bodenfliese 30 x 60 cm



Bodenfliese 60 x 60 cm



Waschtisch SURF[®] large 55 x 120 cm
(auf Anfrage lieferbar). Weitere Informationen zu Surf auf Seite 293 ff.



Bodenfliese 60 x 120 cm



Bodenfliese 120 x 120 cm



R10/A R10/B



cremebeige



mittelbraun



mittelgrau



basalt



anthrazit



anthrazit bunt



Treppenfliese 30 x 60 cm (rilliert)

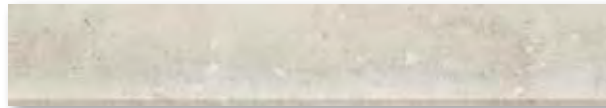

Kehlsockel 10 x 60 cm

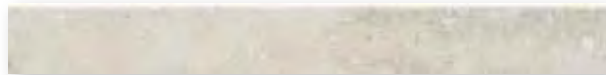

Sockel gerundet 7 x 60 cm

Mosaik 5 x 5 cm



Mosaik, eben
5 x 5 cm



Treppenfliese mit Schräge 31 x 135 cm



Setzstufe 28 x 135 cm

Mosaik

Bodenfliesen

5 x 5 cm

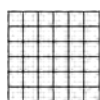

15 x 15 cm



15 x 15 cm



10 x 60 cm^{1/2}



15 x 60 cm^{1/2}



Mosaik, Verklebung
 rückseitig auf
 Glasfasernetz
 Bogen: 297 x 297 mm

Riegelformat

Riegelformat

	5 x 5 / 2 x 2	15 x 15 / 6 x 6	15 x 15 / 6 x 6	10 x 60 / 4 x 24	15 x 60 / 6 x 24	Nennmaß - cm/in
	47 x 47 x 10,5 mm	147 x 147 x 8 mm	147 x 147 x 8 mm	97 x 597 x 10,5 mm	147 x 597 x 10,5 mm	Herstellmaß
	eben, matt	eben, matt	eben, matt	eben, matt	eben, matt	Oberfläche
	11,111 Bögen	44,444	44,444	16,667	11,111	m ² - Stück
	22,222	17,555	17,555	23,667	23,222	m ² - kg
	11 Bögen	35	35	15	11	Paket - Stück
	0,990	0,788	0,788	0,900	0,990	Paket - m ²
	22,000	13,825	13,825	21,300	22,990	Paket - kg
	29,700	63,001	63,001	35,993	39,600	Palette - m ²
	660,000	1.106,000	1.106,000	852,000	919,600	Palette - kg
	Alb	Bla	Bla	Alb	Alb	Produktnorm
	R10/B	R10/B	R11/C	R10/A	R10/A	Trittsicherheit
	2 - 3	2	2	2 - 3	2 - 3	Belastung
	431801H	431807H	431873H	<i>431817H</i>	<i>431823H</i>	cremebeige
	Preisgr. A245 (m ²)	Preisgr. A125 (m ²)	Preisgr. A125 (m ²)	Preisgr. A184 (m ²)	Preisgr. A184 (m ²)	
	431802H	431808H	431874H	<i>431818H</i>	<i>431824H</i>	mittelbraun
	Preisgr. A245 (m ²)	Preisgr. A125 (m ²)	Preisgr. A125 (m ²)	Preisgr. A184 (m ²)	Preisgr. A184 (m ²)	
	431803H	431809H	431875H	<i>431819H</i>	<i>431825H</i>	mittelgrau
	Preisgr. A245 (m ²)	Preisgr. A125 (m ²)	Preisgr. A125 (m ²)	Preisgr. A184 (m ²)	Preisgr. A184 (m ²)	
	431804H	431810H	431876H	<i>431820H</i>	<i>431826H</i>	basalt
	Preisgr. A245 (m ²)	Preisgr. A125 (m ²)	Preisgr. A125 (m ²)	Preisgr. A184 (m ²)	Preisgr. A184 (m ²)	
	431805H	431811H	431877H	<i>431821H</i>	<i>431827H</i>	anthrazit
	Preisgr. A245 (m ²)	Preisgr. A125 (m ²)	Preisgr. A125 (m ²)	Preisgr. A184 (m ²)	Preisgr. A184 (m ²)	
	431806H			<i>431822H</i>	<i>431828H</i>	anthrazit
	Preisgr. A245 (m ²)			Preisgr. A184 (m ²)	Preisgr. A184 (m ²)	bunt



1 rektifiziert



2 Auftragsfertigung: Rückgabe und/oder Stornierung bestellter Ware nicht möglich.



Bodenfliesen

30 x 60 cm¹



30 x 60 cm¹



60 x 60 cm^{1/2}



	30 x 60 / 12 x 24	30 x 60 / 12 x 24	60 x 60 / 24 x 24	Nennmaß - cm/in
	297 x 597 x 10,5 mm	297 x 597 x 10,5 mm	597 x 597 x 10,5 mm	Herstellmaß
	eben, matt	eben, matt	eben, matt	Oberfläche
	5,556	5,556	2,778	m ² - Stück
	23,224	23,224	23,769	m ² - kg
	6	6	3	Paket - Stück
	1,080	1,080	1,080	Paket - m ²
	25,080	25,080	25,668	Paket - kg
	43,197	43,197	32,397	Palette - m ²
	1.003,200	1.003,200	770,040	Palette - kg
	Alb	Alb	Alb	Produktnorm
	R10/A	R11/B	R10/A	Trittsicherheit
	2 - 3	2 - 3	2 - 3	Belastung
	431829H	431835H	431840H	cremebeige
	Preisgr. A110 (m ²)	Preisgr. A119 (m ²)	Preisgr. A125 (m ²)	
	431830H	431836H	431841H	mittelbraun
	Preisgr. A110 (m ²)	Preisgr. A119 (m ²)	Preisgr. A125 (m ²)	
	431831H	431837H	431842H	mittelgrau
	Preisgr. A110 (m ²)	Preisgr. A119 (m ²)	Preisgr. A125 (m ²)	
	431832H	431838H	431843H	basalt
	Preisgr. A110 (m ²)	Preisgr. A119 (m ²)	Preisgr. A125 (m ²)	
	431833H	431839H	431844H	anthrazit
	Preisgr. A110 (m ²)	Preisgr. A119 (m ²)	Preisgr. A125 (m ²)	
	431834H		431845H	anthrazit
	Preisgr. A110 (m ²)		Preisgr. A125 (m ²)	bunt



1 rektifiziert

2 Hohes Gewicht! Karton bitte nur zu Zweit transportieren.



Bodenfliesen

Treppenfliese

Treppenfliese mit Schräge

Setzstufe

60 x 120 cm¹

120 x 120 cm^{1/4/5}

30 x 60 cm^{1/2}

31 x 135 cm^{2/3}

28 x 135 cm^{2/3}



Nennmaß - cm/in	60 x 120 / 24 x 48	120 x 120 / 48 x 48		30 x 60 / 12 x 24	31 x 135 / 12 1364 x 53 532	28 x 135 / 11 x 53 5/32	
Herstellmaß	597 x 1197 x 10,5 mm	1197 x 1197 x 6 mm		297 x 597 x 10,5 mm	307 x 1347 x 10,5 mm	280 x 1347 x 10,5 mm	
Oberfläche	eben, matt	eben, matt		eben, matt	eben, matt	eben, matt	
m ² /m - Stück	1,388/m ²	0,694/m ²		1,667/m	0,741/m	0,741/m	
m ² /m - kg	23,804/m ²	13,991/m ²		6,968/m	7,321/m	6,676/m	
Paket - Stück	2	2		6	2	2	
Paket - m ² /m	1,441 m ²	2,881 m ²		3,599 m	2,699 m	2,699 m	
Paket - kg	34,300	40,320		25,080	19,760	18,020	
Palette - m ²	30,259	72,005					
Palette - kg	720,300	1.008,000					
Produktnorm	Alb	Bla		Alb	Alb	Alb	
Trittsicherheit	R10/A	R10/A		R10/A	R10/A	R10/A	
Belastung	2 - 3	1 - 2		2 - 3	2 - 3	2 - 3	
cremebeige	431846H Preisgr. A155 (m ²)	431878 Preisgr. A162 (m ²)		431852H Preisgr. A475 (St.)	431858H Preisgr. A560 (St.)	431788H Preisgr. A528 (St.)	
mittelbraun	431847H Preisgr. A155 (m ²)	431879 Preisgr. A162 (m ²)		431853H Preisgr. A475 (St.)	431859H Preisgr. A560 (St.)	431789H Preisgr. A528 (St.)	
mittelgrau	431848H Preisgr. A155 (m ²)	431880 Preisgr. A162 (m ²)		431854H Preisgr. A475 (St.)	431860H Preisgr. A560 (St.)	431790H Preisgr. A528 (St.)	
basalt	431849H Preisgr. A155 (m ²)	431881 Preisgr. A162 (m ²)		431855H Preisgr. A475 (St.)	431861H Preisgr. A560 (St.)	431791H Preisgr. A528 (St.)	
anthrazit	431850H Preisgr. A155 (m ²)	431882 Preisgr. A162 (m ²)		431856H Preisgr. A475 (St.)	431862H Preisgr. A560 (St.)	431792H Preisgr. A528 (St.)	
anthrazit	431851H Preisgr. A155 (m ²)			431857H Preisgr. A475 (St.)	431863H Preisgr. A560 (St.)	431793H Preisgr. A528 (St.)	
bunt							



1 rektifiziert

2 Auftragsfertigung: Rückgabe und/oder Stornierung bestellter Ware nicht möglich.

3 Nur an den zwei kurzen Seiten rektifiziert! Längsseite kann nicht rektifiziert werden!

4 Achtung: Sonderpalette, Verpackungspauschale 40 €/Palette. Keine Rücknahme, kein Umtausch. / Hohes Gewicht: Karton bitte nur zu Zweit transportieren.

5 Protecta-Vergütung

Alle Produkte: Color Shade Variation V3, Farbe anthrazit bunt V4

Sockel,
gerundet

7 x 60 cm¹



Kehlsockel,
dekoriert

10 x 60 cm^{1/2}



				7 x 60 / 2 13/16 x 24 70 x 597 x 10,5 mm eben, matt	10 x 60 / 4 x 24 100 x 597/35 x 9 mm eben, matt	Nennmaß - cm/in
				1,667	1,667	Herstellmaß
				1,584	2,000	Oberfläche
				15	20	m - Stück
				8,998	11,998	m - kg
				14,250	24,000	Paket - Stück
						Paket - m
						Paket - kg
						Palette - m
						Palette - kg
						Produktnorm
				Alb	Alb	
				431864H	<i>431887H</i>	cremebeige
				Preisgr. A438 (St.)	Preisgr. A445 (St.)	
				431865H	<i>431893H</i>	mittelbraun
				Preisgr. A438 (St.)	Preisgr. A445 (St.)	
				431866H	<i>431894H</i>	mittelgrau
				Preisgr. A438 (St.)	Preisgr. A445 (St.)	
				431867H	<i>431786H</i>	basalt
				Preisgr. A438 (St.)	Preisgr. A445 (St.)	
				431868H	<i>431787H</i>	anthrazit
				Preisgr. A438 (St.)	Preisgr. A445 (St.)	
				431869H		anthrazit bunt
				Preisgr. A438 (St.)		

¹ rektifiziert

² Auftragsfertigung: Rückgabe und/oder Stornierung bestellter Ware nicht möglich.

Die Farbe anthrazit bunt kann aus
produktionstechnischen Gründen
nicht bzw. nur optisch abweichend
hergestellt werden.





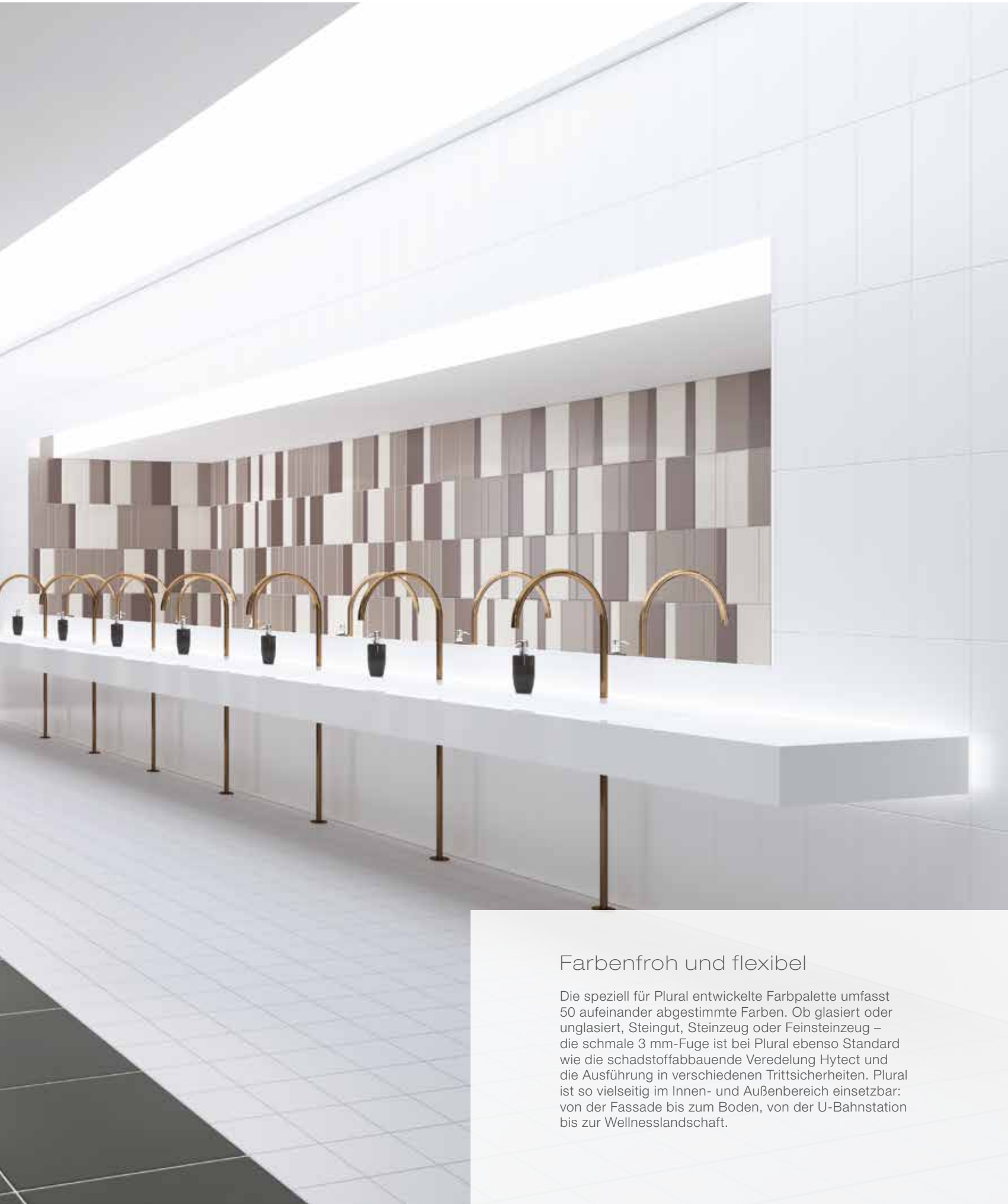

Farbenfroh und flexibel

Die speziell für Plural entwickelte Farbpalette umfasst 50 aufeinander abgestimmte Farben. Ob glasiert oder unglasiert, Steingut, Steinzeug oder Feinsteinzeug – die schmale 3 mm-Fuge ist bei Plural ebenso Standard wie die schadstoffabbauende Veredelung Hytect und die Ausführung in verschiedenen Trittsicherheiten. Plural ist so vielseitig im Innen- und Außenbereich einsetzbar: von der Fassade bis zum Boden, von der U-Bahnstation bis zur Wellnesslandschaft.

				
neutral 10 (aktivweiß)	azur dunkel	azur mittel	azur hell	azur aktiv
				
neutral 9 (weißgrau)	blau dunkel	blau mittel	blau hell	blau aktiv
				
neutral 8 (lichtgrau)	türkis dunkel	türkis mittel	türkis hell	türkis aktiv
				
neutral 7 (kieselgrau)	grün dunkel	grün mittel	grün hell	grün aktiv
				
neutral 6 (perlgrau)	gelb dunkel	gelb mittel	gelb hell	gelb aktiv
				
neutral 5 (basaltgrau)	ocker dunkel	ocker mittel	ocker hell	ocker aktiv
				
neutral 4 (graphitschwarz)	lachs dunkel	lachs mittel	lachs hell	lachs aktiv
				
neutral 3 (asphaltschwarz)	oxidrot dunkel	oxidrot mittel	oxidrot hell	oxidrot aktiv
				
neutral 2 (anthrazit)	steingrau dunkel	steingrau mittel	steingrau hell	steingrau aktiv
				
neutral 1 (tiefschwarz)	sandgrau dunkel	sandgrau mittel	sandgrau hell	sandgrau aktiv

Formate Steingut



Wandfliese 10 x 20 cm



Wandfliese 15 x 15 cm

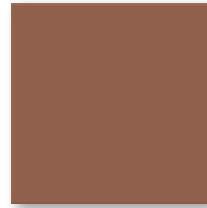

Wandfliese 20 x 20 cm

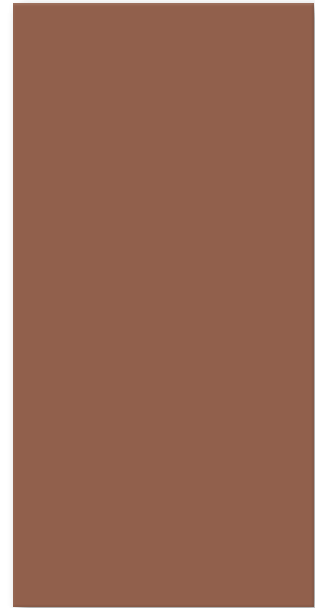

Wandfliese 30 x 60 cm



Wandfliese 10 x 30 cm

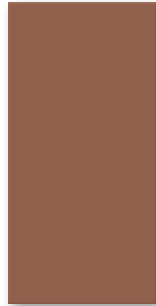

Wandfliese 15 x 30 cm



Wandfliese 20 x 40 cm



Wandfliese 10 x 40 cm



Wandfliese 20 x 60 cm



Wandfliese 10 x 60 cm

Wandfliesen

10 x 20 cm



10 x 30 cm



10 x 40 cm



10 x 60 cm

15 x 15 cm^{2/3}15 x 15 cm²15 x 30 cm²

Nennmaß - cm/in	10 x 20 / 4 x 8	10 x 30 / 4 x 12	10 x 40 / 4 x 16	10 x 60 / 4 x 24	15 x 15 / 6 x 6	15 x 15 / 6 x 6	15 x 30 / 6 x 12
Herstellmaß	97 x 197 x 6,5 mm	97 x 297 x 9 mm	97 x 397 x 7,5 mm	97 x 597 x 9 mm	147 x 147 x 6,5 mm	147 x 147 x 6,5 mm	147 x 297 x 6,5 mm
Oberfläche	seidenmatt, OP-geeig.	seidenmatt, OP-geeig.	seidenmatt, OP-geeig.	seidenmatt, OP-geeig.	glänzend	seidenmatt, OP-geeig.	seidenmatt, OP-geeig.
m ² - Stück	50,000	33,333	25,000	16,667	44,000	44,000	22,222
m ² - kg	11,050	14,100	13,375	14,084	11,000	11,000	9,955
Paket - Stück	33	16	12	16	44	44	24
Paket - m ²	0,660	0,480	0,480	0,960	1,000	1,000	1,080
Paket - kg	7,293	6,768	6,420	13,520	11,000	11,000	10,752
Palette - m ²	59,400	65,281	46,080	38,399	100,000	100,000	91,801
Palette - kg	656,370	920,448	616,320	540,800	1.100,000	1.100,000	913,920
Produktnorm	BIII	BIII	BIII	BIII	BIII	BIII	BIII
neutral 10 (aktivweiß glzd.)	120-1121H³ Preisgr. A125 (m ²)	113-1121H³ Preisgr. A101 (m ²)	140-1121H³ Preisgr. A101 (m ²)	160-1121H³ Preisgr. A119 (m ²)	115-1121H³ Preisgr. A60 (m ²)		130-1121H³ Preisgr. A101 (m ²)
neutral 10 (aktivweiß)	120-1120H Preisgr. A125 (m ²)	113-1120H Preisgr. A101 (m ²)	140-1120H Preisgr. A101 (m ²)	160-1120H Preisgr. A119 (m ²)		116-1120H Preisgr. A60 (m ²)	130-1120H Preisgr. A101 (m ²)
neutral 9 (weißgrau)	120-1119H Preisgr. A150 (m ²)	113-1119H¹ Preisgr. A169 (m ²)	140-1119H Preisgr. A125 (m ²)	160-1119H Preisgr. A139 (m ²)	115-1119H Preisgr. A81 (m ²)	116-1119H Preisgr. A81 (m ²)	130-1119H Preisgr. A125 (m ²)
neutral 8 (lichtgrau)	120-1118H¹ Preisgr. A169 (m ²)	113-1118H¹ Preisgr. A169 (m ²)	140-1118H¹ Preisgr. A150 (m ²)	160-1118H¹ Preisgr. A157 (m ²)	115-1118H¹ Preisgr. A101 (m ²)	116-1118H Preisgr. A60 (m ²)	130-1118H¹ Preisgr. A150 (m ²)
neutral 7 (kieselgrau)	120-1117H Preisgr. A150 (m ²)	113-1117H¹ Preisgr. A169 (m ²)	140-1117H Preisgr. A125 (m ²)	160-1117H Preisgr. A139 (m ²)	115-1117H Preisgr. A81 (m ²)	116-1117H Preisgr. A81 (m ²)	130-1117H Preisgr. A125 (m ²)
neutral 6 (perlgrau)	120-1116H¹ Preisgr. A169 (m ²)	113-1116H¹ Preisgr. A169 (m ²)	140-1116H¹ Preisgr. A150 (m ²)	160-1116H¹ Preisgr. A157 (m ²)	115-1116H¹ Preisgr. A101 (m ²)	116-1116H Preisgr. A81 (m ²)	130-1116H¹ Preisgr. A150 (m ²)
neutral 5 (basaltgrau)	120-1115H Preisgr. A150 (m ²)	113-1115H¹ Preisgr. A169 (m ²)	140-1115H Preisgr. A125 (m ²)	160-1115H Preisgr. A139 (m ²)	115-1115H Preisgr. A81 (m ²)	116-1115H Preisgr. A81 (m ²)	130-1115H Preisgr. A125 (m ²)
neutral 4 (graphitschwarz)	120-1114H¹ Preisgr. A169 (m ²)	113-1114H¹ Preisgr. A169 (m ²)	140-1114H¹ Preisgr. A150 (m ²)	160-1114H¹ Preisgr. A157 (m ²)	115-1114H¹ Preisgr. A101 (m ²)	116-1114H Preisgr. A81 (m ²)	130-1114H¹ Preisgr. A150 (m ²)
neutral 3 (asphaltschwarz)	120-1113H Preisgr. A150 (m ²)	113-1113H¹ Preisgr. A169 (m ²)	140-1113H Preisgr. A125 (m ²)	160-1113H Preisgr. A139 (m ²)	115-1113H Preisgr. A81 (m ²)	116-1113H Preisgr. A81 (m ²)	130-1113H Preisgr. A125 (m ²)
neutral 2 (anthrazit)	120-1112H¹ Preisgr. A169 (m ²)	113-1112H¹ Preisgr. A169 (m ²)	140-1112H¹ Preisgr. A150 (m ²)	160-1112H¹ Preisgr. A157 (m ²)	115-1112H¹ Preisgr. A101 (m ²)	116-1112H Preisgr. A81 (m ²)	130-1112H¹ Preisgr. A150 (m ²)
neutral 1 (tiefschwarz)	120-1111H Preisgr. A150 (m ²)	113-1111H¹ Preisgr. A169 (m ²)	140-1111H Preisgr. A125 (m ²)	160-1111H Preisgr. A139 (m ²)	115-1111H Preisgr. A81 (m ²)	116-1111H Preisgr. A81 (m ²)	130-1111H Preisgr. A125 (m ²)
azur aktiv	120-1001H¹ Preisgr. A169 (m ²)	113-1001H¹ Preisgr. A169 (m ²)	140-1001H¹ Preisgr. A150 (m ²)	160-1001H¹ Preisgr. A157 (m ²)	115-1001H¹ Preisgr. A101 (m ²)	116-1001H¹ Preisgr. A101 (m ²)	130-1001H¹ Preisgr. A150 (m ²)
azur hell	120-1002H¹ Preisgr. A169 (m ²)	113-1002H¹ Preisgr. A169 (m ²)	140-1002H¹ Preisgr. A150 (m ²)	160-1002H¹ Preisgr. A157 (m ²)	115-1002H¹ Preisgr. A101 (m ²)	116-1002H Preisgr. A81 (m ²)	130-1002H¹ Preisgr. A150 (m ²)
azur mittel	120-1003H¹ Preisgr. A169 (m ²)	113-1003H¹ Preisgr. A169 (m ²)	140-1003H¹ Preisgr. A150 (m ²)	160-1003H¹ Preisgr. A157 (m ²)	115-1003H¹ Preisgr. A101 (m ²)	116-1003H¹ Preisgr. A101 (m ²)	130-1003H¹ Preisgr. A150 (m ²)
azur dunkel	120-1004H Preisgr. A150 (m ²)	113-1004H¹ Preisgr. A169 (m ²)	140-1004H Preisgr. A125 (m ²)	160-1004H Preisgr. A139 (m ²)	115-1004H Preisgr. A81 (m ²)	116-1004H Preisgr. A81 (m ²)	130-1004H Preisgr. A125 (m ²)
blau aktiv	120-1005H¹ Preisgr. A169 (m ²)	113-1005H¹ Preisgr. A169 (m ²)	140-1005H¹ Preisgr. A150 (m ²)	160-1005H¹ Preisgr. A157 (m ²)	115-1005H¹ Preisgr. A101 (m ²)	116-1005H¹ Preisgr. A101 (m ²)	130-1005H¹ Preisgr. A150 (m ²)
blau hell	120-1006H¹ Preisgr. A169 (m ²)	113-1006H¹ Preisgr. A169 (m ²)	140-1006H¹ Preisgr. A150 (m ²)	160-1006H¹ Preisgr. A157 (m ²)	115-1006H¹ Preisgr. A101 (m ²)	116-1006H Preisgr. A81 (m ²)	130-1006H¹ Preisgr. A150 (m ²)
blau mittel	120-1007H¹ Preisgr. A169 (m ²)	113-1007H¹ Preisgr. A169 (m ²)	140-1007H¹ Preisgr. A150 (m ²)	160-1007H¹ Preisgr. A157 (m ²)	115-1007H¹ Preisgr. A101 (m ²)	116-1007H¹ Preisgr. A101 (m ²)	130-1007H¹ Preisgr. A150 (m ²)
blau dunkel	120-1008H Preisgr. A150 (m ²)	113-1008H¹ Preisgr. A169 (m ²)	140-1008H Preisgr. A125 (m ²)	160-1008H Preisgr. A139 (m ²)	115-1008H Preisgr. A81 (m ²)	116-1008H Preisgr. A81 (m ²)	130-1008H Preisgr. A125 (m ²)
türkis aktiv	120-1009H¹ Preisgr. A169 (m ²)	113-1009H¹ Preisgr. A169 (m ²)	140-1009H¹ Preisgr. A150 (m ²)	160-1009H¹ Preisgr. A157 (m ²)	115-1009H¹ Preisgr. A101 (m ²)	116-1009H¹ Preisgr. A101 (m ²)	130-1009H¹ Preisgr. A150 (m ²)
türkis hell	120-1010H¹ Preisgr. A169 (m ²)	113-1010H¹ Preisgr. A169 (m ²)	140-1010H¹ Preisgr. A150 (m ²)	160-1010H¹ Preisgr. A157 (m ²)	115-1010H¹ Preisgr. A101 (m ²)	116-1010H Preisgr. A81 (m ²)	130-1010H¹ Preisgr. A150 (m ²)
türkis mittel	120-1011H¹ Preisgr. A169 (m ²)	113-1011H¹ Preisgr. A169 (m ²)	140-1011H¹ Preisgr. A150 (m ²)	160-1011H¹ Preisgr. A157 (m ²)	115-1011H¹ Preisgr. A101 (m ²)	116-1011H¹ Preisgr. A101 (m ²)	130-1011H¹ Preisgr. A150 (m ²)
türkis dunkel	120-1012H Preisgr. A150 (m ²)	113-1012H¹ Preisgr. A169 (m ²)	140-1012H Preisgr. A125 (m ²)	160-1012H Preisgr. A139 (m ²)	115-1012H Preisgr. A81 (m ²)	116-1012H Preisgr. A81 (m ²)	130-1012H Preisgr. A125 (m ²)
grün aktiv	120-1013H¹ Preisgr. A169 (m ²)	113-1013H¹ Preisgr. A169 (m ²)	140-1013H¹ Preisgr. A150 (m ²)	160-1013H¹ Preisgr. A157 (m ²)	115-1013H¹ Preisgr. A101 (m ²)	116-1013H¹ Preisgr. A101 (m ²)	130-1013H¹ Preisgr. A150 (m ²)
grün hell	120-1014H¹ Preisgr. A169 (m ²)	113-1014H¹ Preisgr. A169 (m ²)	140-1014H¹ Preisgr. A150 (m ²)	160-1014H¹ Preisgr. A157 (m ²)	115-1014H¹ Preisgr. A101 (m ²)	116-1014H Preisgr. A81 (m ²)	130-1014H¹ Preisgr. A150 (m ²)
grün mittel	120-1015H¹ Preisgr. A169 (m ²)	113-1015H¹ Preisgr. A169 (m ²)	140-1015H¹ Preisgr. A150 (m ²)	160-1015H¹ Preisgr. A157 (m ²)	115-1015H¹ Preisgr. A101 (m ²)	116-1015H¹ Preisgr. A101 (m ²)	130-1015H¹ Preisgr. A150 (m ²)
grün dunkel	120-1016H Preisgr. A150 (m ²)	113-1016H¹ Preisgr. A169 (m ²)	140-1016H Preisgr. A125 (m ²)	160-1016H Preisgr. A139 (m ²)	115-1016H Preisgr. A81 (m ²)	116-1016H Preisgr. A81 (m ²)	130-1016H Preisgr. A125 (m ²)

Auftragsfertigung: Rückgabe und/oder Stornierung bestellter Ware nicht möglich.

² Eine überglasierte Kopfkante 10 % pro Lieferung. Kanten jeweils zu 2/3 überglasiert.

³ Nicht OP-geeignet.

Wandfliesen

20 x 20 cm²



20 x 40 cm²



20 x 60 cm



30 x 60 cm



			20 x 20 / 8 x 8	20 x 40 / 8 x 16	20 x 60 / 8 x 24	30 x 60 / 12 x 24	Nennmaß - cm/in
			197 x 197 x 6,5 mm	197 x 397 x 7,5 mm	197 x 597 x 9 mm	297 x 597 x 9 mm	Herstellmaß
			seidenmatt, OP-geeig.	seidenmatt, OP-geeig.	seidenmatt, OP-geeig.	seidenmatt, OP-geeig.	Oberfläche
			25,000	12,500	8,333	5,556	m ² - Stück
			11,200	12,638	15,516	14,946	m ² - kg
			25	16	8	9	Paket - Stück
			1,000	1,280	0,960	1,620	Paket - m ²
			11,200	16,176	14,896	24,210	Paket - kg
			96,000	92,160	61,442	77,754	Palette - m ²
			1.075,200	1.164,672	953,344	1.162,080	Palette - kg
			Bill	Bill	Bill	Bill	Produktnorm
			220-1121H³	240-1121H³	260-1121H³	360-1121H³	neutral 10
			Preisgr. A67 (m ²)	Preisgr. A101 (m ²)	Preisgr. A125 (m ²)	Preisgr. A125 (m ²)	(aktivweiß glzd.)
			220-1120H	240-1120H	260-1120H	360-1120H	neutral 10
			Preisgr. A67 (m ²)	Preisgr. A101 (m ²)	Preisgr. A125 (m ²)	Preisgr. A125 (m ²)	(aktivweiß)
			220-1119H	240-1119H	260-1119H	360-1119H	neutral 9
			Preisgr. A94 (m ²)	Preisgr. A125 (m ²)	Preisgr. A150 (m ²)	Preisgr. A150 (m ²)	(weißgrau)
			220-1118H	240-1118H¹	260-1118H¹	360-1118H	neutral 8
			Preisgr. A67 (m ²)	Preisgr. A150 (m ²)	Preisgr. A169 (m ²)	Preisgr. A150 (m ²)	(lichtgrau)
			220-1117H	240-1117H	260-1117H	360-1117H	neutral 7
			Preisgr. A94 (m ²)	Preisgr. A125 (m ²)	Preisgr. A150 (m ²)	Preisgr. A150 (m ²)	(kieselgrau)
			220-1116H	240-1116H¹	260-1116H¹	360-1116H¹	neutral 6
			Preisgr. A94 (m ²)	Preisgr. A150 (m ²)	Preisgr. A169 (m ²)	Preisgr. A169 (m ²)	(perlgrau)
			220-1115H	240-1115H	260-1115H	360-1115H	neutral 5
			Preisgr. A94 (m ²)	Preisgr. A125 (m ²)	Preisgr. A150 (m ²)	Preisgr. A150 (m ²)	(basaltgrau)
			220-1114H	240-1114H¹	260-1114H¹	360-1114H¹	neutral 4
			Preisgr. A94 (m ²)	Preisgr. A150 (m ²)	Preisgr. A169 (m ²)	Preisgr. A169 (m ²)	(graphitschwarz)
			220-1113H	240-1113H	260-1113H	360-1113H	neutral 3
			Preisgr. A94 (m ²)	Preisgr. A125 (m ²)	Preisgr. A150 (m ²)	Preisgr. A150 (m ²)	(asphaltschwarz)
			220-1112H	240-1112H¹	260-1112H¹	360-1112H¹	neutral 2
			Preisgr. A94 (m ²)	Preisgr. A150 (m ²)	Preisgr. A169 (m ²)	Preisgr. A169 (m ²)	(anthrazit)
			220-1111H	240-1111H	260-1111H	360-1111H	neutral 1
			Preisgr. A94 (m ²)	Preisgr. A125 (m ²)	Preisgr. A150 (m ²)	Preisgr. A150 (m ²)	(tiefschwarz)
			220-1001H¹	240-1001H¹	260-1001H¹	360-1001H¹	
			Preisgr. A119 (m ²)	Preisgr. A150 (m ²)	Preisgr. A169 (m ²)	Preisgr. A169 (m ²)	azur aktiv
			220-1002H	240-1002H	260-1002H¹	360-1002H¹	
			Preisgr. A94 (m ²)	Preisgr. A125 (m ²)	Preisgr. A169 (m ²)	Preisgr. A169 (m ²)	azur hell
			220-1003H¹	240-1003H¹	260-1003H¹	360-1003H¹	
			Preisgr. A119 (m ²)	Preisgr. A150 (m ²)	Preisgr. A169 (m ²)	Preisgr. A169 (m ²)	azur mittel
			220-1004H	240-1004H	260-1004H	360-1004H	
			Preisgr. A94 (m ²)	Preisgr. A125 (m ²)	Preisgr. A150 (m ²)	Preisgr. A150 (m ²)	azur dunkel
			220-1005H¹	240-1005H¹	260-1005H¹	360-1005H¹	
			Preisgr. A119 (m ²)	Preisgr. A150 (m ²)	Preisgr. A169 (m ²)	Preisgr. A169 (m ²)	blau aktiv
			220-1006H	240-1006H	260-1006H¹	360-1006H¹	
			Preisgr. A94 (m ²)	Preisgr. A125 (m ²)	Preisgr. A169 (m ²)	Preisgr. A169 (m ²)	blau hell
			220-1007H¹	240-1007H¹	260-1007H¹	360-1007H¹	
			Preisgr. A119 (m ²)	Preisgr. A150 (m ²)	Preisgr. A169 (m ²)	Preisgr. A169 (m ²)	blau mittel
			220-1008H	240-1008H	260-1008H	360-1008H	
			Preisgr. A94 (m ²)	Preisgr. A125 (m ²)	Preisgr. A150 (m ²)	Preisgr. A150 (m ²)	blau dunkel
			220-1009H¹	240-1009H¹	260-1009H¹	360-1009H¹	
			Preisgr. A119 (m ²)	Preisgr. A150 (m ²)	Preisgr. A169 (m ²)	Preisgr. A169 (m ²)	türkis aktiv
			220-1010H	240-1010H	260-1010H¹	360-1010H¹	
			Preisgr. A94 (m ²)	Preisgr. A125 (m ²)	Preisgr. A169 (m ²)	Preisgr. A169 (m ²)	türkis hell
			220-1011H¹	240-1011H¹	260-1011H¹	360-1011H¹	
			Preisgr. A119 (m ²)	Preisgr. A150 (m ²)	Preisgr. A169 (m ²)	Preisgr. A169 (m ²)	türkis mittel
			220-1012H	240-1012H	260-1012H	360-1012H	
			Preisgr. A94 (m ²)	Preisgr. A125 (m ²)	Preisgr. A150 (m ²)	Preisgr. A150 (m ²)	türkis dunkel
			220-1013H¹	240-1013H¹	260-1013H¹	360-1013H¹	
			Preisgr. A119 (m ²)	Preisgr. A150 (m ²)	Preisgr. A169 (m ²)	Preisgr. A169 (m ²)	grün aktiv
			220-1014H	240-1014H	260-1014H¹	360-1014H¹	
			Preisgr. A94 (m ²)	Preisgr. A125 (m ²)	Preisgr. A169 (m ²)	Preisgr. A169 (m ²)	grün hell
			220-1015H¹	240-1015H¹	260-1015H¹	360-1015H¹	
			Preisgr. A119 (m ²)	Preisgr. A150 (m ²)	Preisgr. A169 (m ²)	Preisgr. A169 (m ²)	grün mittel
			220-1016H	240-1016H	260-1016H	360-1016H	
			Preisgr. A94 (m ²)	Preisgr. A125 (m ²)	Preisgr. A150 (m ²)	Preisgr. A150 (m ²)	grün dunkel

¹ Auftragsfertigung: Rückgabe und/oder Stornierung bestellter Ware nicht möglich.

² Eine überglasierte Kopfkante 10 % pro Lieferung. Kanten jeweils zu 2/3 überglasiert.

³ Nicht OP-geeignet.

Wandfliesen

10 x 20 cm



10 x 30 cm



10 x 40 cm



10 x 60 cm

15 x 15 cm^{2/3}15 x 15 cm²15 x 30 cm²

Nennmaß - cm/in	10 x 20 / 4 x 8	10 x 30 / 4 x 12	10 x 40 / 4 x 16	10 x 60 / 4 x 24	15 x 15 / 6 x 6	15 x 15 / 6 x 6	15 x 30 / 6 x 12
Herstellmaß	97 x 197 x 6,5 mm	97 x 297 x 9 mm	97 x 397 x 7,5 mm	97 x 597 x 9 mm	147 x 147 x 6,5 mm	147 x 147 x 6,5 mm	147 x 297 x 6,5 mm
Oberfläche	seidenmatt, OP-geeig.	seidenmatt, OP-geeig.	seidenmatt, OP-geeig.	seidenmatt, OP-geeig.	glänzend	seidenmatt, OP-geeig.	seidenmatt, OP-geeig.
m ² - Stück	50,000	33,333	25,000	16,667	44,000	44,000	22,222
m ² - kg	11,050	14,100	13,375	14,084	11,000	11,000	9,955
Paket - Stück	33	16	12	16	44	44	24
Paket - m ²	0,660	0,480	0,480	0,960	1,000	1,000	1,080
Paket - kg	7,293	6,768	6,420	13,520	11,000	11,000	10,752
Palette - m ²	59,400	65,281	46,080	38,399	100,000	100,000	91,801
Palette - kg	656,370	920,448	616,320	540,800	1.100,000	1.100,000	913,920
Produktnorm	BIII	BIII	BIII	BIII	BIII	BIII	BIII
gelb aktiv	120-1017H ¹ Preisgr. A169 (m ²)	113-1017H ¹ Preisgr. A169 (m ²)	140-1017H ¹ Preisgr. A150 (m ²)	160-1017H ¹ Preisgr. A157 (m ²)	115-1017H ¹ Preisgr. A101 (m ²)	116-1017H ¹ Preisgr. A101 (m ²)	130-1017H ¹ Preisgr. A150 (m ²)
gelb hell	120-1018H ¹ Preisgr. A169 (m ²)	113-1018H ¹ Preisgr. A169 (m ²)	140-1018H ¹ Preisgr. A150 (m ²)	160-1018H ¹ Preisgr. A157 (m ²)	115-1018H ¹ Preisgr. A101 (m ²)	116-1018H ¹ Preisgr. A81 (m ²)	130-1018H ¹ Preisgr. A150 (m ²)
gelb mittel	120-1019H ¹ Preisgr. A169 (m ²)	113-1019H ¹ Preisgr. A169 (m ²)	140-1019H ¹ Preisgr. A150 (m ²)	160-1019H ¹ Preisgr. A157 (m ²)	115-1019H ¹ Preisgr. A101 (m ²)	116-1019H ¹ Preisgr. A101 (m ²)	130-1019H ¹ Preisgr. A150 (m ²)
gelb dunkel	120-1020H ¹ Preisgr. A150 (m ²)	113-1020H ¹ Preisgr. A169 (m ²)	140-1020H ¹ Preisgr. A125 (m ²)	160-1020H ¹ Preisgr. A139 (m ²)	115-1020H ¹ Preisgr. A81 (m ²)	116-1020H ¹ Preisgr. A81 (m ²)	130-1020H ¹ Preisgr. A125 (m ²)
ocker aktiv	120-1021H ¹ Preisgr. A169 (m ²)	113-1021H ¹ Preisgr. A169 (m ²)	140-1021H ¹ Preisgr. A150 (m ²)	160-1021H ¹ Preisgr. A157 (m ²)	115-1021H ¹ Preisgr. A101 (m ²)	116-1021H ¹ Preisgr. A101 (m ²)	130-1021H ¹ Preisgr. A150 (m ²)
ocker hell	120-1022H ¹ Preisgr. A169 (m ²)	113-1022H ¹ Preisgr. A169 (m ²)	140-1022H ¹ Preisgr. A150 (m ²)	160-1022H ¹ Preisgr. A157 (m ²)	115-1022H ¹ Preisgr. A101 (m ²)	116-1022H ¹ Preisgr. A81 (m ²)	130-1022H ¹ Preisgr. A150 (m ²)
ocker mittel	120-1023H ¹ Preisgr. A169 (m ²)	113-1023H ¹ Preisgr. A169 (m ²)	140-1023H ¹ Preisgr. A150 (m ²)	160-1023H ¹ Preisgr. A157 (m ²)	115-1023H ¹ Preisgr. A101 (m ²)	116-1023H ¹ Preisgr. A101 (m ²)	130-1023H ¹ Preisgr. A150 (m ²)
ocker dunkel	120-1024H ¹ Preisgr. A150 (m ²)	113-1024H ¹ Preisgr. A169 (m ²)	140-1024H ¹ Preisgr. A125 (m ²)	160-1024H ¹ Preisgr. A139 (m ²)	115-1024H ¹ Preisgr. A81 (m ²)	116-1024H ¹ Preisgr. A81 (m ²)	130-1024H ¹ Preisgr. A125 (m ²)
lachs aktiv	120-1025H ¹ Preisgr. A169 (m ²)	113-1025H ¹ Preisgr. A169 (m ²)	140-1025H ¹ Preisgr. A150 (m ²)	160-1025H ¹ Preisgr. A157 (m ²)	115-1025H ¹ Preisgr. A101 (m ²)	116-1025H ¹ Preisgr. A101 (m ²)	130-1025H ¹ Preisgr. A150 (m ²)
lachs hell	120-1026H ¹ Preisgr. A169 (m ²)	113-1026H ¹ Preisgr. A169 (m ²)	140-1026H ¹ Preisgr. A150 (m ²)	160-1026H ¹ Preisgr. A157 (m ²)	115-1026H ¹ Preisgr. A101 (m ²)	116-1026H ¹ Preisgr. A81 (m ²)	130-1026H ¹ Preisgr. A150 (m ²)
lachs mittel	120-1027H ¹ Preisgr. A169 (m ²)	113-1027H ¹ Preisgr. A169 (m ²)	140-1027H ¹ Preisgr. A150 (m ²)	160-1027H ¹ Preisgr. A157 (m ²)	115-1027H ¹ Preisgr. A101 (m ²)	116-1027H ¹ Preisgr. A101 (m ²)	130-1027H ¹ Preisgr. A150 (m ²)
lachs dunkel	120-1028H ¹ Preisgr. A150 (m ²)	113-1028H ¹ Preisgr. A169 (m ²)	140-1028H ¹ Preisgr. A125 (m ²)	160-1028H ¹ Preisgr. A139 (m ²)	115-1028H ¹ Preisgr. A81 (m ²)	116-1028H ¹ Preisgr. A81 (m ²)	130-1028H ¹ Preisgr. A125 (m ²)
oxidrot aktiv	120-1029H ¹ Preisgr. A169 (m ²)	113-1029H ¹ Preisgr. A169 (m ²)	140-1029H ¹ Preisgr. A150 (m ²)	160-1029H ¹ Preisgr. A157 (m ²)	115-1029H ¹ Preisgr. A101 (m ²)	116-1029H ¹ Preisgr. A101 (m ²)	130-1029H ¹ Preisgr. A150 (m ²)
oxidrot hell	120-1030H ¹ Preisgr. A169 (m ²)	113-1030H ¹ Preisgr. A169 (m ²)	140-1030H ¹ Preisgr. A150 (m ²)	160-1030H ¹ Preisgr. A157 (m ²)	115-1030H ¹ Preisgr. A101 (m ²)	116-1030H ¹ Preisgr. A81 (m ²)	130-1030H ¹ Preisgr. A150 (m ²)
oxidrot mittel	120-1031H ¹ Preisgr. A169 (m ²)	113-1031H ¹ Preisgr. A169 (m ²)	140-1031H ¹ Preisgr. A150 (m ²)	160-1031H ¹ Preisgr. A157 (m ²)	115-1031H ¹ Preisgr. A101 (m ²)	116-1031H ¹ Preisgr. A101 (m ²)	130-1031H ¹ Preisgr. A150 (m ²)
oxidrot dunkel	120-1032H ¹ Preisgr. A150 (m ²)	113-1032H ¹ Preisgr. A169 (m ²)	140-1032H ¹ Preisgr. A125 (m ²)	160-1032H ¹ Preisgr. A139 (m ²)	115-1032H ¹ Preisgr. A81 (m ²)	116-1032H ¹ Preisgr. A81 (m ²)	130-1032H ¹ Preisgr. A125 (m ²)
steingrau aktiv	120-1033H ¹ Preisgr. A169 (m ²)	113-1033H ¹ Preisgr. A169 (m ²)	140-1033H ¹ Preisgr. A150 (m ²)	160-1033H ¹ Preisgr. A157 (m ²)	115-1033H ¹ Preisgr. A101 (m ²)	116-1033H ¹ Preisgr. A101 (m ²)	130-1033H ¹ Preisgr. A150 (m ²)
steingrau hell	120-1034H ¹ Preisgr. A169 (m ²)	113-1034H ¹ Preisgr. A169 (m ²)	140-1034H ¹ Preisgr. A150 (m ²)	160-1034H ¹ Preisgr. A157 (m ²)	115-1034H ¹ Preisgr. A101 (m ²)	116-1034H ¹ Preisgr. A81 (m ²)	130-1034H ¹ Preisgr. A150 (m ²)
steingrau mittel	120-1035H ¹ Preisgr. A169 (m ²)	113-1035H ¹ Preisgr. A169 (m ²)	140-1035H ¹ Preisgr. A150 (m ²)	160-1035H ¹ Preisgr. A157 (m ²)	115-1035H ¹ Preisgr. A101 (m ²)	116-1035H ¹ Preisgr. A101 (m ²)	130-1035H ¹ Preisgr. A150 (m ²)
steingrau dunkel	120-1036H ¹ Preisgr. A150 (m ²)	113-1036H ¹ Preisgr. A169 (m ²)	140-1036H ¹ Preisgr. A125 (m ²)	160-1036H ¹ Preisgr. A139 (m ²)	115-1036H ¹ Preisgr. A81 (m ²)	116-1036H ¹ Preisgr. A81 (m ²)	130-1036H ¹ Preisgr. A125 (m ²)
sandgrau aktiv	120-1037H ¹ Preisgr. A169 (m ²)	113-1037H ¹ Preisgr. A169 (m ²)	140-1037H ¹ Preisgr. A150 (m ²)	160-1037H ¹ Preisgr. A157 (m ²)	115-1037H ¹ Preisgr. A101 (m ²)	116-1037H ¹ Preisgr. A101 (m ²)	130-1037H ¹ Preisgr. A150 (m ²)
sandgrau hell	120-1038H ¹ Preisgr. A169 (m ²)	113-1038H ¹ Preisgr. A125 (m ²)	140-1038H ¹ Preisgr. A125 (m ²)	160-1038H ¹ Preisgr. A157 (m ²)	115-1038H ¹ Preisgr. A81 (m ²)	116-1038H ¹ Preisgr. A81 (m ²)	130-1038H ¹ Preisgr. A125 (m ²)
sandgrau mittel	120-1039H ¹ Preisgr. A169 (m ²)	113-1039H ¹ Preisgr. A169 (m ²)	140-1039H ¹ Preisgr. A150 (m ²)	160-1039H ¹ Preisgr. A157 (m ²)	115-1039H ¹ Preisgr. A101 (m ²)	116-1039H ¹ Preisgr. A101 (m ²)	130-1039H ¹ Preisgr. A125 (m ²)
sandgrau dunkel	120-1040H ¹ Preisgr. A150 (m ²)	113-1040H ¹ Preisgr. A169 (m ²)	140-1040H ¹ Preisgr. A125 (m ²)	160-1040H ¹ Preisgr. A139 (m ²)	115-1040H ¹ Preisgr. A81 (m ²)	116-1040H ¹ Preisgr. A81 (m ²)	130-1040H ¹ Preisgr. A125 (m ²)

¹  Auftragsfertigung: Rückgabe und/oder Stornierung bestellter Ware nicht möglich.² Eine überglasierte Kopfkante 10 % pro Lieferung. Kanten jeweils zu 2/3 überglasiert.³ Nicht OP-geeignet.

Wandfliesen

20 x 20 cm²



20 x 40 cm²



20 x 60 cm



30 x 60 cm





















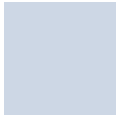





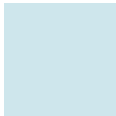



























			20 x 20 / 8 x 8	20 x 40 / 8 x 16	20 x 60 / 8 x 24	30 x 60 / 12 x 24	Nennmaß - cm/in
			197 x 197 x 6,5 mm	197 x 397 x 7,5 mm	197 x 597 x 9 mm	297 x 597 x 9 mm	Herstellmaß
			seidenmatt, OP-geeig.	seidenmatt, OP-geeig.	seidenmatt, OP-geeig.	seidenmatt, OP-geeig.	Oberfläche
			25,000	12,500	8,333	5,556	m ² - Stück
			11,200	12,638	15,516	14,946	m ² - kg
			25	16	8	9	Paket - Stück
			1,000	1,280	0,960	1,620	Paket - m ²
			11,200	16,176	14,896	24,210	Paket - kg
			96,000	92,160	61,442	77,754	Palette - m ²
			1.075,200	1.164,672	953,344	1.162,080	Palette - kg
			Bill	Bill	Bill	Bill	Produktnorm
			220-1017H ¹	240-1017H ¹	260-1017H ¹	360-1017H ¹	gelb aktiv
			Preisgr. A119 (m ²)	Preisgr. A150 (m ²)	Preisgr. A169 (m ²)	Preisgr. A169 (m ²)	
			220-1018H	240-1018H	260-1018H ¹	360-1018H ¹	gelb hell
			Preisgr. A94 (m ²)	Preisgr. A125 (m ²)	Preisgr. A169 (m ²)	Preisgr. A169 (m ²)	
			220-1019H ¹	240-1019H ¹	260-1019H ¹	360-1019H ¹	gelb mittel
			Preisgr. A119 (m ²)	Preisgr. A150 (m ²)	Preisgr. A169 (m ²)	Preisgr. A169 (m ²)	
			220-1020H	240-1020H	260-1020H	360-1020H	gelb dunkel
			Preisgr. A94 (m ²)	Preisgr. A125 (m ²)	Preisgr. A150 (m ²)	Preisgr. A150 (m ²)	
			220-1021H ¹	240-1021H ¹	260-1021H ¹	360-1021H ¹	ocker aktiv
			Preisgr. A119 (m ²)	Preisgr. A150 (m ²)	Preisgr. A169 (m ²)	Preisgr. A169 (m ²)	
			220-1022H	240-1022H	260-1022H ¹	360-1022H ¹	ocker hell
			Preisgr. A94 (m ²)	Preisgr. A125 (m ²)	Preisgr. A169 (m ²)	Preisgr. A169 (m ²)	
			220-1023H ¹	240-1023H ¹	260-1023H ¹	360-1023H ¹	ocker mittel
			Preisgr. A119 (m ²)	Preisgr. A150 (m ²)	Preisgr. A169 (m ²)	Preisgr. A169 (m ²)	
			220-1024H	240-1024H	260-1024H	360-1024H	ocker dunkel
			Preisgr. A94 (m ²)	Preisgr. A125 (m ²)	Preisgr. A150 (m ²)	Preisgr. A150 (m ²)	
			220-1025H ¹	240-1025H ¹	260-1025H ¹	360-1025H ¹	lachs aktiv
			Preisgr. A119 (m ²)	Preisgr. A150 (m ²)	Preisgr. A169 (m ²)	Preisgr. A169 (m ²)	
			220-1026H	240-1026H	260-1026H ¹	360-1026H ¹	lachs hell
			Preisgr. A94 (m ²)	Preisgr. A125 (m ²)	Preisgr. A169 (m ²)	Preisgr. A169 (m ²)	
			220-1027H ¹	240-1027H ¹	260-1027H ¹	360-1027H ¹	lachs mittel
			Preisgr. A119 (m ²)	Preisgr. A150 (m ²)	Preisgr. A169 (m ²)	Preisgr. A169 (m ²)	
			220-1028H	240-1028H	260-1028H	360-1028H	lachs dunkel
			Preisgr. A94 (m ²)	Preisgr. A125 (m ²)	Preisgr. A150 (m ²)	Preisgr. A150 (m ²)	
			220-1029H ¹	240-1029H ¹	260-1029H ¹	360-1029H ¹	oxidrot aktiv
			Preisgr. A119 (m ²)	Preisgr. A150 (m ²)	Preisgr. A169 (m ²)	Preisgr. A169 (m ²)	
			220-1030H	240-1030H	260-1030H ¹	360-1030H ¹	oxidrot hell
			Preisgr. A94 (m ²)	Preisgr. A125 (m ²)	Preisgr. A169 (m ²)	Preisgr. A169 (m ²)	
			220-1031H ¹	240-1031H ¹	260-1031H ¹	360-1031H ¹	oxidrot mittel
			Preisgr. A119 (m ²)	Preisgr. A150 (m ²)	Preisgr. A169 (m ²)	Preisgr. A169 (m ²)	
			220-1032H	240-1032H	260-1032H	360-1032H	oxidrot dunkel
			Preisgr. A94 (m ²)	Preisgr. A125 (m ²)	Preisgr. A150 (m ²)	Preisgr. A150 (m ²)	
			220-1033H ¹	240-1033H ¹	260-1033H ¹	360-1033H ¹	steingrau aktiv
			Preisgr. A119 (m ²)	Preisgr. A150 (m ²)	Preisgr. A169 (m ²)	Preisgr. A169 (m ²)	
			220-1034H	240-1034H	260-1034H ¹	360-1034H ¹	steingrau hell
			Preisgr. A94 (m ²)	Preisgr. A125 (m ²)	Preisgr. A169 (m ²)	Preisgr. A169 (m ²)	
			220-1035H ¹	240-1035H ¹	260-1035H ¹	360-1035H ¹	steingrau mittel
			Preisgr. A119 (m ²)	Preisgr. A150 (m ²)	Preisgr. A169 (m ²)	Preisgr. A169 (m ²)	
			220-1036H	240-1036H	260-1036H	360-1036H	steingrau dunkel
			Preisgr. A94 (m ²)	Preisgr. A125 (m ²)	Preisgr. A150 (m ²)	Preisgr. A150 (m ²)	
			220-1037H ¹	240-1037H ¹	260-1037H ¹	360-1037H ¹	sandgrau aktiv
			Preisgr. A119 (m ²)	Preisgr. A150 (m ²)	Preisgr. A169 (m ²)	Preisgr. A169 (m ²)	
			220-1038H	240-1038H	260-1038H ¹	360-1038H	sandgrau hell
			Preisgr. A94 (m ²)	Preisgr. A125 (m ²)	Preisgr. A169 (m ²)	Preisgr. A150 (m ²)	
			220-1039H	240-1039H ¹	260-1039H ¹	360-1039H ¹	sandgrau mittel
			Preisgr. A94 (m ²)	Preisgr. A150 (m ²)	Preisgr. A169 (m ²)	Preisgr. A169 (m ²)	
			220-1040H	240-1040H	260-1040H	360-1040H	sandgrau dunkel
			Preisgr. A94 (m ²)	Preisgr. A125 (m ²)	Preisgr. A150 (m ²)	Preisgr. A150 (m ²)	

¹ Auftragsfertigung: Rückgabe und/oder Stornierung bestellter Ware nicht möglich.

² Eine überglasierte Kopfkante 10 % pro Lieferung. Kanten jeweils zu 2/3 überglasiert.

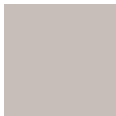
³ Nicht OP-geeignet.

Plural
Kontrastfarben

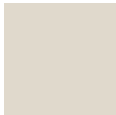
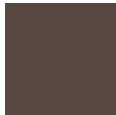
					
neutral 10 (aktivweiß)	azur dunkel	azur mittel	azur hell	azur aktiv	tiefanthrazit
					
neutral 9 (weißgrau)	blau dunkel	blau mittel	blau hell	blau aktiv	tiefblau
					
neutral 8 (lichtgrau)	türkis dunkel	türkis mittel	türkis hell	türkis aktiv	tiefgrün
					
neutral 7 (kieselgrau)	grün dunkel	grün mittel	grün hell	grün aktiv	tiefgelb
					
neutral 6 (perlgrau)	gelb dunkel	gelb mittel	gelb hell	gelb aktiv	tieforange
					
neutral 5 (basaltgrau)	ocker dunkel	ocker mittel	ocker hell	ocker aktiv	tiefrot
					
neutral 4 (graphitschwarz)	lachs dunkel	lachs mittel	lachs hell	lachs aktiv	
					
neutral 3 (asphaltschwarz)	oxidrot dunkel	oxidrot mittel	oxidrot hell	oxidrot aktiv	
					
neutral 2 (anthrazit)	steingrau dunkel	steingrau mittel	steingrau hell	steingrau aktiv	
					
neutral 1 (tiefschwarz)	sandgrau dunkel	sandgrau mittel	sandgrau hell	sandgrau aktiv	

Formate Steinzeug

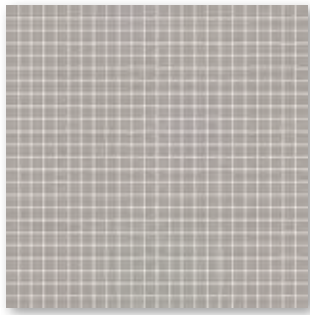

Mosaik 1 x 1 cm

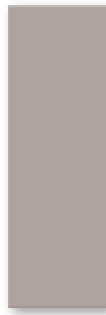

Boden-/Wandfliese
10 x 30 cm

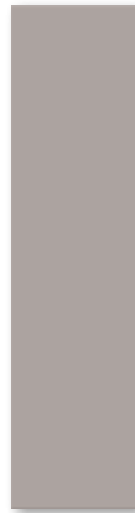

Boden-/Wandfliese
12,5 x 50 cm

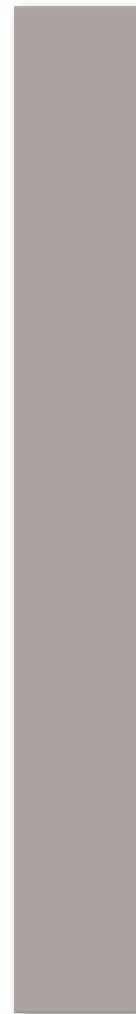

Boden-/Wandfliese
12,5 x 100 cm

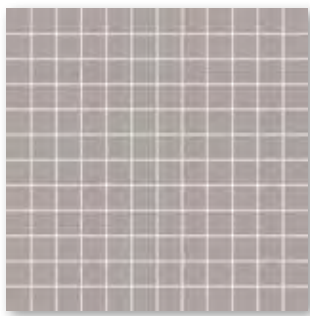

Mosaik 2,5 x 2,5 cm

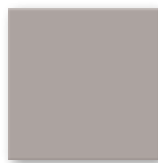

Boden-/Wandfliese
15 x 15 cm

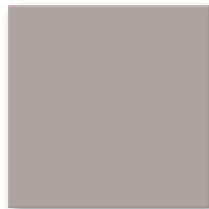

Boden-/Wandfliese
20 x 20 cm

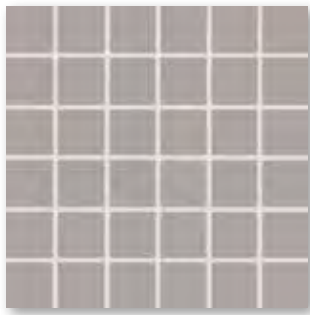

Mosaik 5 x 5 cm

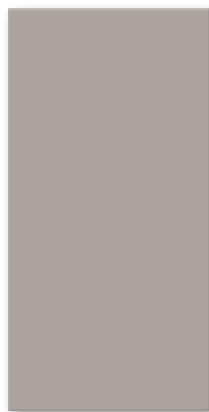

Boden-/Wandfliese
20 x 40 cm

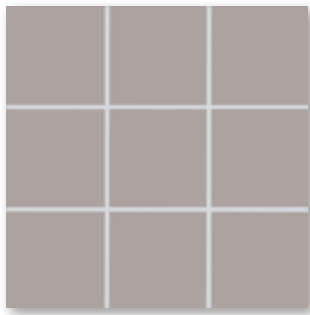

Mosaik 10 x 10 cm

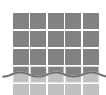

Rückseitig thermoplastisch verklebte Mosaik von AGROB BUCHTAL sind nicht nur im Trockenbereich, sondern auch bedenkenlos im Unterwasserbereich (z. B. Schwimmbecken/Whirlpool) sowie im dauernassbelasteten Bereich (z. B. Beckenumgänge/Duschen) einsetzbar.

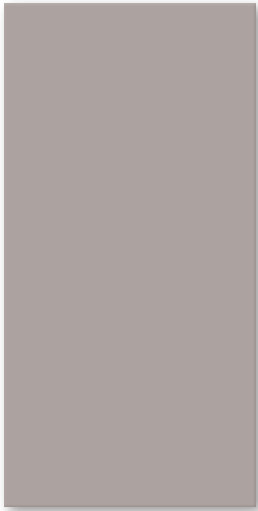

*Boden-/Wandfliese
25 x 50 cm*



*Boden-/Wandfliese
30 x 30 cm*

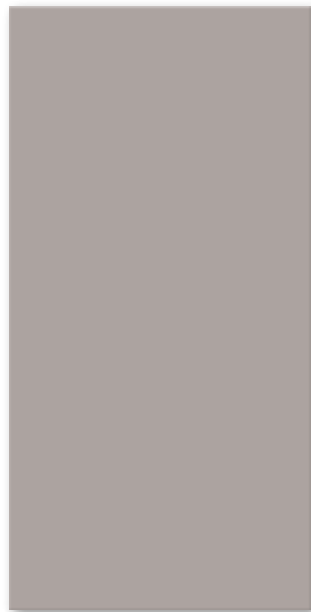

*Boden-/Wandfliese
30 x 60 cm*

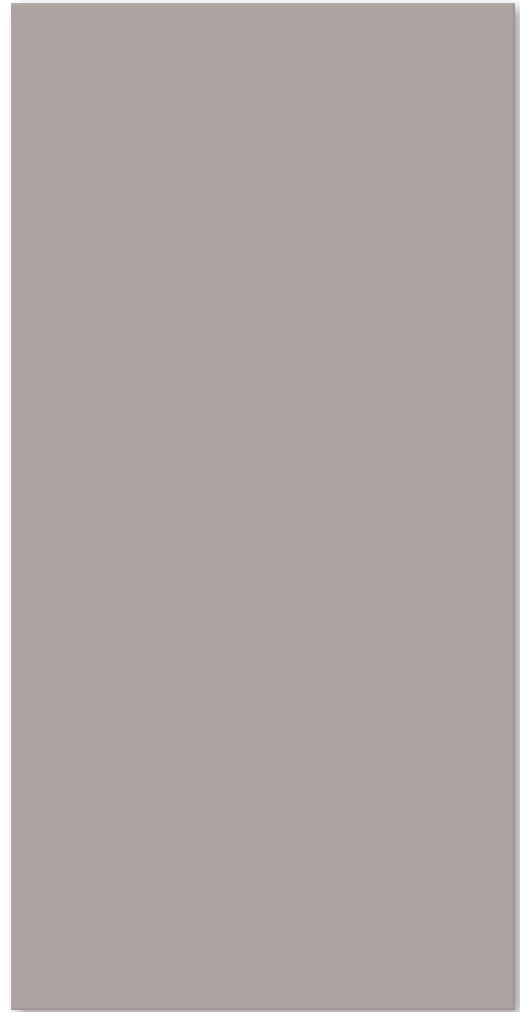

*Boden-/Wandfliese
50 x 100 cm*



*Kehlsockel, eben
10 x 10 cm*



*Innenecke
eben*



*Außenecke
eben*

Mosaik

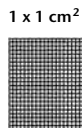

Mosaik, rückseitig
 thermoplastisch verklebt
 Bogen: 313 x 313 mm

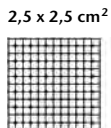

Mosaik, rückseitig
 thermoplastisch verklebt
 Bogen: 297 x 297 mm

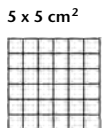

Mosaik, rückseitig
 thermoplastisch verklebt
 Bogen: 297 x 297 mm

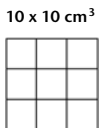

Mosaik, rückseitig
 thermoplastisch verklebt
 Bogen: 297 x 297 mm

Boden-/Wandfliesen

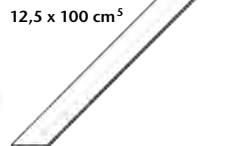
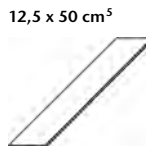

1 x 1 / 3/8 x 3/8	2,5 x 2,5 / 1 x 1	5 x 5 / 2 x 2	10 x 10 / 4 x 4	10 x 30 / 4 x 12	12,5 x 50 / 5 x 20	12,5 x 100 / 5 x 40	Beanspruchungsgruppe
12 x 12 x 6,5 mm	23 x 23 x 6,5 mm	47 x 47 x 6,5 mm	97 x 97 x 6,5 mm	97 x 297 x 6 mm	122 x 497 x 8 mm	122 x 997 x 8 mm	Formatnummer
eben, OP-geeig.	eben, OP-geeig.	eben, OP-geeig.	eben, OP-geeig.	eben, seidenmatt ⁶	eben, seidenmatt ⁶	eben, seidenmatt ⁶	Nennmaß - cm/in
10,000 Bögen	11 Bögen	11 Bögen	11 Bögen	33,333	16,000	8,000	Herstellmaß
11,930	12,100	12,331	13,101	12,333	17,040	17,040	Oberfläche
10 Bögen	11 Bögen	11 Bögen	11 Bögen	38	8	10	m ² - Stück
1,000	1,000	1,000	1,000	1,140	0,500	1,250	Paket - Stück
11,930	12,100	12,331	13,101	14,060	8,520	21,300	Paket - m ²
24,000	48,000	64,000	64,000	95,761	55,000	67,500	Paket - kg
286,320	580,800	789,184	838,464	1.181,040	937,200	1.150,200	Palette - m ²
Blb	Blb	Blb	Blb	Alb	Alb	Alb	Palette - kg
1 - 2	1 - 2	1 - 2	1 - 2	1 - 2	1 - 2	1 - 2	Produktnorm
701-2120H ¹ Preisgr. A349 (m ²)	702-2120H Preisgr. A205 (m ²)	705-2120H Preisgr. A157 (m ²)	710-2120H Preisgr. A101 (m ²)	703-2120H Preisgr. A119 (m ²)	700i-341550HK Preisgr. A177 (m ²)	700i-352010HK Preisgr. A245 (m ²)	Belastung
701-2119H ¹ Preisgr. A349 (m ²)	702-2119H¹ Preisgr. A245 (m ²)	705-2119H Preisgr. A169 (m ²)	710-2119H Preisgr. A150 (m ²)	703-2119H¹ Preisgr. A169 (m ²)	552119-341550HK¹ Preisgr. A233 (m ²)	552119-352010HK¹ Preisgr. A306 (m ²)	4 neutral 10 (aktivweiß glzd.)
701-2118H ¹ Preisgr. A349 (m ²)	702-2118H Preisgr. A205 (m ²)	705-2118H Preisgr. A157 (m ²)	710-2118H Preisgr. A101 (m ²)	703-2118H Preisgr. A119 (m ²)	552118-341550HK Preisgr. A177 (m ²)	552118-352010HK Preisgr. A245 (m ²)	4 neutral 10 (aktivweiß)
701-2117H ¹ Preisgr. A349 (m ²)	702-2117H¹ Preisgr. A245 (m ²)	705-2117H Preisgr. A169 (m ²)	710-2117H Preisgr. A150 (m ²)	703-2117H¹ Preisgr. A169 (m ²)	552117-341550HK Preisgr. A205 (m ²)	552117-352010HK Preisgr. A205 (m ²)	4 neutral 9 (weißgrau)
701-2116H ¹ Preisgr. A349 (m ²)	702-2116H¹ Preisgr. A245 (m ²)	705-2116H¹ Preisgr. A233 (m ²)	710-2116H¹ Preisgr. A169 (m ²)	703-2116H¹ Preisgr. A169 (m ²)	552116-341550HK¹ Preisgr. A233 (m ²)	552116-352010HK¹ Preisgr. A306 (m ²)	4 neutral 8 (lichtgrau)
701-2115H ¹ Preisgr. A349 (m ²)	702-2115H¹ Preisgr. A245 (m ²)	705-2115H Preisgr. A169 (m ²)	710-2115H Preisgr. A150 (m ²)	703-2115H¹ Preisgr. A169 (m ²)	552115-341550HK¹ Preisgr. A233 (m ²)	552115-352010HK¹ Preisgr. A306 (m ²)	4 neutral 7 (kieselgrau)
701-2114H ¹ Preisgr. A349 (m ²)	702-2114H¹ Preisgr. A245 (m ²)	705-2114H Preisgr. A169 (m ²)	710-2114H Preisgr. A150 (m ²)	703-2114H^{1/4} Preisgr. A169 (m ²)	552114-341550HK^{1/4} Preisgr. A233 (m ²)	552114-352010HK^{1/4} Preisgr. A306 (m ²)	3 neutral 6 (perlgrau)
701-2113H ¹ Preisgr. A349 (m ²)	702-2113H¹ Preisgr. A245 (m ²)	705-2113H Preisgr. A169 (m ²)	710-2113H Preisgr. A150 (m ²)	703-2113H Preisgr. A150 (m ²)	552113-341550HK Preisgr. A205 (m ²)	552113-352010HK Preisgr. A277 (m ²)	3 neutral 5 (basaltgrau)
701-2112H ¹ Preisgr. A349 (m ²)	702-2112H¹ Preisgr. A245 (m ²)	705-2112H Preisgr. A169 (m ²)	710-2112H Preisgr. A150 (m ²)	703-2112H¹ Preisgr. A169 (m ²)	552112-341550HK¹ Preisgr. A233 (m ²)	552112-352010HK¹ Preisgr. A306 (m ²)	3 neutral 4 (graphitschwarz)
701-2111H ¹ Preisgr. A349 (m ²)	702-2111H Preisgr. A230 (m ²)	705-2111H Preisgr. A169 (m ²)	710-2111H Preisgr. A150 (m ²)	703-2111H⁴ Preisgr. A169 (m ²)	5716-341550HK^{1/4} Preisgr. A233 (m ²)	5716-352010HK^{1/4} Preisgr. A306 (m ²)	3 neutral 3 (asphaltschwarz)
701-2001H ¹ Preisgr. A349 (m ²)	702-2001H¹ Preisgr. A245 (m ²)	705-2001H Preisgr. A169 (m ²)	710-2001H Preisgr. A150 (m ²)	703-2001H Preisgr. A150 (m ²)	552001-341550HK Preisgr. A205 (m ²)	552001-352010HK Preisgr. A277 (m ²)	2 neutral 2 (anthrazit)
701-2002H ¹ Preisgr. A349 (m ²)	702-2002H¹ Preisgr. A245 (m ²)	705-2002H Preisgr. A169 (m ²)	710-2002H Preisgr. A150 (m ²)	703-2002H¹ Preisgr. A169 (m ²)	552002-341550HK¹ Preisgr. A233 (m ²)	552002-352010HK¹ Preisgr. A306 (m ²)	1 neutral 1 (tiefschwarz)
701-2003H ¹ Preisgr. A349 (m ²)	702-2003H Preisgr. A230 (m ²)	705-2003H Preisgr. A169 (m ²)	710-2003H Preisgr. A150 (m ²)	703-2003H Preisgr. A150 (m ²)	552003-341550HK Preisgr. A205 (m ²)	552003-352010HK Preisgr. A277 (m ²)	2 azur aktiv
701-2004H ¹ Preisgr. A349 (m ²)	702-2004H Preisgr. A230 (m ²)	705-2004H Preisgr. A169 (m ²)	710-2004H Preisgr. A150 (m ²)	703-2004H¹ Preisgr. A169 (m ²)	552004-341550HK¹ Preisgr. A233 (m ²)	552004-352010HK¹ Preisgr. A306 (m ²)	4 azur hell
701-2005H ¹ Preisgr. A349 (m ²)	702-2005H¹ Preisgr. A245 (m ²)	705-2005H Preisgr. A169 (m ²)	710-2005H Preisgr. A150 (m ²)	703-2005H¹ Preisgr. A169 (m ²)	552005-341550HK¹ Preisgr. A233 (m ²)	552005-352010HK¹ Preisgr. A306 (m ²)	3 azur mittel
701-2006H ¹ Preisgr. A349 (m ²)	702-2006H¹ Preisgr. A245 (m ²)	705-2006H Preisgr. A169 (m ²)	710-2006H Preisgr. A150 (m ²)	703-2006H¹ Preisgr. A169 (m ²)	552006-341550HK¹ Preisgr. A233 (m ²)	552006-352010HK¹ Preisgr. A306 (m ²)	2 azur dunkel
701-2007H ¹ Preisgr. A349 (m ²)	702-2007H¹ Preisgr. A245 (m ²)	705-2007H Preisgr. A169 (m ²)	710-2007H Preisgr. A150 (m ²)	703-2007H¹ Preisgr. A169 (m ²)	552007-341550HK¹ Preisgr. A233 (m ²)	552007-352010HK¹ Preisgr. A306 (m ²)	2 blau aktiv
701-2008H ¹ Preisgr. A349 (m ²)	702-2008H Preisgr. A230 (m ²)	705-2008H Preisgr. A169 (m ²)	710-2008H Preisgr. A150 (m ²)	703-2008H¹ Preisgr. A169 (m ²)	552008-341550HK¹ Preisgr. A233 (m ²)	552008-352010HK¹ Preisgr. A306 (m ²)	4 blau hell
701-2009H ¹ Preisgr. A349 (m ²)	702-2009H¹ Preisgr. A245 (m ²)	705-2009H Preisgr. A169 (m ²)	710-2009H Preisgr. A150 (m ²)	703-2009H¹ Preisgr. A169 (m ²)	552009-341550HK¹ Preisgr. A233 (m ²)	552009-352010HK¹ Preisgr. A306 (m ²)	3 blau mittel
701-2010H ¹ Preisgr. A349 (m ²)	702-2010H¹ Preisgr. A245 (m ²)	705-2010H Preisgr. A169 (m ²)	710-2010H Preisgr. A150 (m ²)	703-2010H¹ Preisgr. A169 (m ²)	552010-341550HK¹ Preisgr. A233 (m ²)	552010-352010HK¹ Preisgr. A306 (m ²)	2 blau dunkel
701-2011H ¹ Preisgr. A349 (m ²)	702-2011H¹ Preisgr. A245 (m ²)	705-2011H Preisgr. A169 (m ²)	710-2011H Preisgr. A150 (m ²)	703-2011H¹ Preisgr. A169 (m ²)	552011-341550HK¹ Preisgr. A233 (m ²)	552011-352010HK¹ Preisgr. A306 (m ²)	2 türkis aktiv
701-2012H ¹ Preisgr. A349 (m ²)	702-2012H¹ Preisgr. A245 (m ²)	705-2012H Preisgr. A169 (m ²)	710-2012H Preisgr. A150 (m ²)	703-2012H⁴ Preisgr. A169 (m ²)	552012-341550HK^{1/4} Preisgr. A233 (m ²)	552012-352010HK^{1/4} Preisgr. A306 (m ²)	4 türkis hell
701-2013H ¹ Preisgr. A349 (m ²)	702-2013H¹ Preisgr. A245 (m ²)	705-2013H Preisgr. A169 (m ²)	710-2013H Preisgr. A150 (m ²)	703-2013H¹ Preisgr. A169 (m ²)	552013-341550HK¹ Preisgr. A233 (m ²)	552013-352010HK¹ Preisgr. A306 (m ²)	3 türkis mittel
701-2014H ¹ Preisgr. A349 (m ²)	702-2014H¹ Preisgr. A245 (m ²)	705-2014H Preisgr. A169 (m ²)	710-2014H Preisgr. A150 (m ²)	703-2014H¹ Preisgr. A169 (m ²)	552014-341550HK¹ Preisgr. A233 (m ²)	552014-352010HK¹ Preisgr. A306 (m ²)	2 türkis dunkel
701-2015H ¹ Preisgr. A349 (m ²)	702-2015H¹ Preisgr. A245 (m ²)	705-2015H Preisgr. A169 (m ²)	710-2015H Preisgr. A150 (m ²)	703-2015H¹ Preisgr. A169 (m ²)	552015-341550HK¹ Preisgr. A233 (m ²)	552015-352010HK¹ Preisgr. A306 (m ²)	2 grün aktiv
701-2016H ¹ Preisgr. A349 (m ²)	702-2016H¹ Preisgr. A245 (m ²)	705-2016H Preisgr. A169 (m ²)	710-2016H Preisgr. A150 (m ²)	703-2016H¹ Preisgr. A169 (m ²)	552016-341550HK¹ Preisgr. A233 (m ²)	552016-352010HK¹ Preisgr. A306 (m ²)	4 grün hell
							3 grün mittel
							2 grün dunkel

¹ Auftragsfertigung: Rückgabe und/oder Stornierung bestellter Ware nicht möglich.

² Auf Anfrage können auch definierte Farbverläufe und Mosaikbilder geliefert werden.

³ Überglastierte Kanten anteilsmäßig im Bogen

⁴ Produktionsbedingte Farbabweichung zum Standard ist möglich.
⁵ rektifiziert

⁶ Ausnahme: neutral 10 (glänzend), eben, glänzend



Boden-/Wandfliesen

15 x 15 cm



20 x 20 cm



20 x 40 cm



25 x 50 cm³



30 x 30 cm³



30 x 60 cm³



50 x 100 cm³

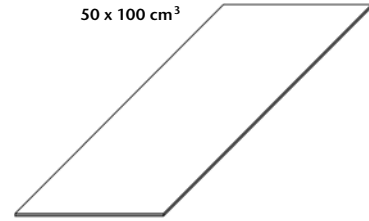

Formatnummer	15 x 15 cm	20 x 20 cm	20 x 40 cm	25 x 50 cm ³	30 x 30 cm ³	30 x 60 cm ³	50 x 100 cm ³
Nennmaß - cm/in	15 x 15 / 6 x 6	20 x 20 / 8 x 8	20 x 40 / 8 x 16	25 x 50 / 10 x 20	30 x 30 / 12 x 12	30 x 60 / 12 x 24	50 x 100 / 20 x 40
Herstellmaß	147 x 147 x 6,5 mm	197 x 197 x 6,5 mm	197 x 397 x 6,5 mm	247 x 497 x 8 mm	297 x 297 x 8 mm	297 x 597 x 8 mm	497 x 997 x 8 mm
Oberfläche	eben, OP-geeig.	eben, OP-geeig.	eben, OP-geeig.	eben, seidenmatt ⁴	eben, seidenmatt ⁴	eben, seidenmatt ⁴	eben, seidenmatt ⁴
m ² - Stück	44,000	25,000	12,500	8,000	11,111	5,556	2,000
m ² - kg	13,816	13,875	14,100	17,040	17,222	17,413	18,080
Paket - Stück	44	25	16	9	14	6	2
Paket - m ²	1,000	1,000	1,280	1,125	1,260	1,080	1,000
Paket - kg	13,816	13,875	18,048	19,170	21,700	18,804	18,080
Palette - m ²	80,000	72,000	72,960	40,500	52,921	43,197	52,000
Palette - kg	1.105,280	999,000	1.028,736	690,120	911,410	752,242	940,160
Produktnorm	Blb	Blb	Blb	Alb	Alb	Alb	Alb
Belastung	1 - 2	1 - 2	1 - 2	1 - 2	1 - 2	1 - 2	1 - 2
neutral 10 (aktivweiß glzd.)	4			700i-342550HK Preisgr. A150 (m ²)	730-2121H Preisgr. A150 (m ²)	760-2121H Preisgr. A150 (m ²)	352050HK Preisgr. A177 (m ²)
neutral 10 (aktivweiß)	4	715-2120H Preisgr. A94 (m ²)	720-2120H Preisgr. A94 (m ²)	740-2120H Preisgr. A119 (m ²)	701i-342550HK Preisgr. A150 (m ²)	730-2120H Preisgr. A150 (m ²)	760-2120H Preisgr. A150 (m ²)
neutral 9 (weißgrau)	4	715-2119H ¹ Preisgr. A169 (m ²)	720-2119H ¹ Preisgr. A139 (m ²)	740-2119H ¹ Preisgr. A169 (m ²)	552119-342550HK Preisgr. A177 (m ²)	730-2119H ¹ Preisgr. A209 (m ²)	760-2119H ¹ Preisgr. A233 (m ²)
neutral 8 (lichtgrau)	4	715-2118H Preisgr. A94 (m ²)	720-2118H Preisgr. A94 (m ²)	740-2118H Preisgr. A119 (m ²)	552118-342550HK Preisgr. A150 (m ²)	730-2118H Preisgr. A150 (m ²)	760-2118H Preisgr. A150 (m ²)
neutral 7 (kieselgrau)	4	715-2117H ¹ Preisgr. A139 (m ²)	720-2117H ¹ Preisgr. A139 (m ²)	740-2117H ¹ Preisgr. A169 (m ²)	552117-342550HK Preisgr. A177 (m ²)	730-2117H ¹ Preisgr. A209 (m ²)	760-2117H ¹ Preisgr. A233 (m ²)
neutral 6 (perlgrau)	3	715-2116H ¹ Preisgr. A139 (m ²)	720-2116H ¹ Preisgr. A139 (m ²)	740-2116H ¹ Preisgr. A169 (m ²)	552116-342550HK Preisgr. A177 (m ²)	730-2116H ¹ Preisgr. A209 (m ²)	760-2116H ¹ Preisgr. A233 (m ²)
neutral 5 (basaltgrau)	3	715-2115H ¹ Preisgr. A139 (m ²)	720-2115H ¹ Preisgr. A139 (m ²)	740-2115H ¹ Preisgr. A169 (m ²)	552115-342550HK Preisgr. A177 (m ²)	730-2115H ¹ Preisgr. A209 (m ²)	760-2115H ¹ Preisgr. A233 (m ²)
neutral 4 (graphitschwarz)	3	715-2114H Preisgr. A119 (m ²)	720-2114H Preisgr. A119 (m ²)	740-2114H ¹ Preisgr. A169 (m ²)	552114-342550HK ² Preisgr. A177 (m ²)	730-2114H ^{1/2} Preisgr. A209 (m ²)	760-2114H ^{1/2} Preisgr. A233 (m ²)
neutral 3 (asphaltschwarz)	3	715-2113H ¹ Preisgr. A139 (m ²)	720-2113H ¹ Preisgr. A139 (m ²)	740-2113H ¹ Preisgr. A169 (m ²)	552113-342550HK Preisgr. A177 (m ²)	730-2113H Preisgr. A177 (m ²)	760-2113H Preisgr. A205 (m ²)
neutral 2 (anthrazit)	2	715-2112H Preisgr. A119 (m ²)	720-2112H Preisgr. A119 (m ²)	740-2112H ¹ Preisgr. A169 (m ²)	552112-342550HK Preisgr. A177 (m ²)	730-2112H ¹ Preisgr. A209 (m ²)	760-2112H Preisgr. A177 (m ²)
neutral 1 (tiefschwarz)	1	715-2111H Preisgr. A119 (m ²)	720-2111H Preisgr. A119 (m ²)	740-2111H Preisgr. A150 (m ²)	5716-342550HK ² Preisgr. A177 (m ²)	730-2111H ² Preisgr. A209 (m ²)	760-2111H ² Preisgr. A209 (m ²)
azur aktiv	2	715-2001H ¹ Preisgr. A139 (m ²)	720-2001H ¹ Preisgr. A139 (m ²)	740-2001H ¹ Preisgr. A169 (m ²)	552001-342550HK Preisgr. A177 (m ²)	730-2001H Preisgr. A177 (m ²)	760-2001H Preisgr. A177 (m ²)
azur hell	4	715-2002H ¹ Preisgr. A139 (m ²)	720-2002H ¹ Preisgr. A139 (m ²)	740-2002H ¹ Preisgr. A169 (m ²)	552002-342550HK Preisgr. A177 (m ²)	730-2002H ¹ Preisgr. A209 (m ²)	760-2002H ¹ Preisgr. A233 (m ²)
azur mittel	3	715-2003H Preisgr. A119 (m ²)	720-2003H Preisgr. A119 (m ²)	740-2003H Preisgr. A150 (m ²)	552003-342550HK Preisgr. A177 (m ²)	730-2003H Preisgr. A177 (m ²)	760-2003H Preisgr. A177 (m ²)
azur dunkel	2	715-2004H ¹ Preisgr. A139 (m ²)	720-2004H Preisgr. A119 (m ²)	740-2004H ¹ Preisgr. A169 (m ²)	552004-342550HK Preisgr. A177 (m ²)	730-2004H ¹ Preisgr. A209 (m ²)	760-2004H ¹ Preisgr. A233 (m ²)
blau aktiv	2	715-2005H ¹ Preisgr. A139 (m ²)	720-2005H ¹ Preisgr. A139 (m ²)	740-2005H ¹ Preisgr. A169 (m ²)	552005-342550HK Preisgr. A177 (m ²)	730-2005H ¹ Preisgr. A209 (m ²)	760-2005H ¹ Preisgr. A233 (m ²)
blau hell	4	715-2006H ¹ Preisgr. A139 (m ²)	720-2006H ¹ Preisgr. A139 (m ²)	740-2006H ¹ Preisgr. A169 (m ²)	552006-342550HK Preisgr. A177 (m ²)	730-2006H ¹ Preisgr. A209 (m ²)	760-2006H ¹ Preisgr. A233 (m ²)
blau mittel	3	715-2007H Preisgr. A119 (m ²)	720-2007H Preisgr. A119 (m ²)	740-2007H Preisgr. A150 (m ²)	552007-342550HK Preisgr. A177 (m ²)	730-2007H ¹ Preisgr. A209 (m ²)	760-2007H ¹ Preisgr. A233 (m ²)
blau dunkel	2	715-2008H ¹ Preisgr. A139 (m ²)	720-2008H Preisgr. A119 (m ²)	740-2008H ¹ Preisgr. A169 (m ²)	552008-342550HK Preisgr. A177 (m ²)	730-2008H ¹ Preisgr. A209 (m ²)	760-2008H ¹ Preisgr. A233 (m ²)
türkis aktiv	2	715-2009H ¹ Preisgr. A139 (m ²)	720-2009H ¹ Preisgr. A139 (m ²)	740-2009H ¹ Preisgr. A169 (m ²)	552009-342550HK Preisgr. A177 (m ²)	730-2009H ¹ Preisgr. A209 (m ²)	760-2009H ¹ Preisgr. A233 (m ²)
türkis hell	4	715-2010H Preisgr. A119 (m ²)	720-2010H Preisgr. A119 (m ²)	740-2010H Preisgr. A150 (m ²)	552010-342550HK Preisgr. A177 (m ²)	730-2010H ¹ Preisgr. A209 (m ²)	760-2010H ¹ Preisgr. A233 (m ²)
türkis mittel	3	715-2011H ¹ Preisgr. A139 (m ²)	720-2011H ¹ Preisgr. A139 (m ²)	740-2011H ¹ Preisgr. A169 (m ²)	552011-342550HK Preisgr. A177 (m ²)	730-2011H ¹ Preisgr. A209 (m ²)	760-2011H ¹ Preisgr. A233 (m ²)
türkis dunkel	2	715-2012H ¹ Preisgr. A139 (m ²)	720-2012H ¹ Preisgr. A139 (m ²)	740-2012H ¹ Preisgr. A169 (m ²)	552012-342550HK ² Preisgr. A177 (m ²)	730-2012H ^{1/2} Preisgr. A209 (m ²)	760-2012H ^{1/2} Preisgr. A233 (m ²)
grün aktiv	2	715-2013H ¹ Preisgr. A139 (m ²)	720-2013H ¹ Preisgr. A139 (m ²)	740-2013H ¹ Preisgr. A169 (m ²)	552013-342550HK Preisgr. A177 (m ²)	730-2013H ¹ Preisgr. A209 (m ²)	760-2013H ¹ Preisgr. A233 (m ²)
grün hell	4	715-2014H Preisgr. A119 (m ²)	720-2014H Preisgr. A119 (m ²)	740-2014H Preisgr. A150 (m ²)	552014-342550HK Preisgr. A177 (m ²)	730-2014H ¹ Preisgr. A209 (m ²)	760-2014H ¹ Preisgr. A233 (m ²)
grün mittel	3	715-2015H ¹ Preisgr. A139 (m ²)	720-2015H ¹ Preisgr. A139 (m ²)	740-2015H ¹ Preisgr. A169 (m ²)	552015-342550HK Preisgr. A177 (m ²)	730-2015H ¹ Preisgr. A209 (m ²)	760-2015H ¹ Preisgr. A233 (m ²)
grün dunkel	2	715-2016H ¹ Preisgr. A139 (m ²)	720-2016H ¹ Preisgr. A139 (m ²)	740-2016H ¹ Preisgr. A169 (m ²)	552016-342550HK Preisgr. A177 (m ²)	730-2016H ¹ Preisgr. A209 (m ²)	760-2016H ¹ Preisgr. A233 (m ²)



¹ Auftragsfertigung: Rückgabe und/oder Stornierung bestellter Ware nicht möglich.

² Produktionsbedingte Farbabweichung zum Standard ist möglich.



³ rektifiziert

⁴ Ausnahme: neutral 10 (glänzend), eben, glänzend

Mosaik

1 x 1 cm²

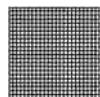

Mosaik, rückseitig
thermoplastisch verklebt
Bogen: 313 x 313 mm

2,5 x 2,5 cm²

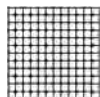

Mosaik, rückseitig
thermoplastisch verklebt
Bogen: 297 x 297 mm

5 x 5 cm²

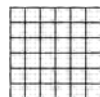

Mosaik, rückseitig
thermoplastisch verklebt
Bogen: 297 x 297 mm

10 x 10 cm³



Mosaik, rückseitig
thermoplastisch verklebt
Bogen: 297 x 297 mm

Boden-/Wandfliesen

10 x 30 cm



12,5 x 50 cm⁵



12,5 x 100 cm⁵



1 x 1 / 3/8 x 3/8	2,5 x 2,5 / 1 x 1	5 x 5 / 2 x 2	10 x 10 / 4 x 4	703	341550HK	352010HK	Beanspruchungsgruppe
12 x 12 x 6,5 mm	23 x 23 x 6,5 mm	47 x 47 x 6,5 mm	97 x 97 x 6,5 mm	10 x 30 / 4 x 12	12,5 x 50 / 5 x 20	12,5 x 100 / 5 x 40	Formatnummer
eben, OP-geeig.	eben, OP-geeig.	eben, OP-geeig.	eben, OP-geeig.	eben, seidenmatt	eben, seidenmatt	eben, seidenmatt	Nennmaß - cm/in
10,000 Bögen	11 Bögen	11 Bögen	11 Bögen	33,333	16,000	8,000	Herstellmaß
11,930	12,100	12,331	13,101	12,333	17,040	17,040	Oberfläche
10 Bögen	11 Bögen	11 Bögen	11 Bögen	38	8	10	m ² - Stück
1,000	1,000	1,000	1,000	1,140	0,500	1,250	m ² - kg
11,930	12,100	12,331	13,101	14,060	8,520	21,300	Paket - Stück
24,000	48,000	64,000	64,000	95,761	55,000	67,500	Paket - m ²
286,320	580,800	789,184	838,464	1.181,040	937,200	1.150,200	Paket - kg
Blb	Blb	Blb	Blb	Alb	Alb	Alb	Palette - m ²
1 - 2	1 - 2	1 - 2	1 - 2	1 - 2	1 - 2	1 - 2	Palette - kg
701-2017H ¹	702-2017H ¹	705-2017H	710-2017H	703-2017H ^{1/4}	552017-341550HK ^{1/4}	552017-352010HK ^{1/4}	Produktnorm
Preisgr. A349 (m ²)	Preisgr. A245 (m ²)	Preisgr. A169 (m ²)	Preisgr. A150 (m ²)	Preisgr. A169 (m ²)	Preisgr. A233 (m ²)	Preisgr. A306 (m ²)	Belastung
701-2018H ¹	702-2018H ¹	705-2018H	710-2018H	703-2018H ¹	552018-341550HK ¹	552018-352010HK ¹	2
Preisgr. A349 (m ²)	Preisgr. A245 (m ²)	Preisgr. A169 (m ²)	Preisgr. A150 (m ²)	Preisgr. A169 (m ²)	Preisgr. A233 (m ²)	Preisgr. A306 (m ²)	gelb aktiv
701-2019H ¹	702-2019H ¹	705-2019H	710-2019H	703-2019H ¹	552019-341550HK ¹	552019-352010HK ¹	4
Preisgr. A349 (m ²)	Preisgr. A245 (m ²)	Preisgr. A169 (m ²)	Preisgr. A150 (m ²)	Preisgr. A169 (m ²)	Preisgr. A233 (m ²)	Preisgr. A306 (m ²)	gelb hell
701-2020H ¹	702-2020H ¹	705-2020H	710-2020H	703-2020H ^{1/4}	552020-341550HK ^{1/4}	552020-352010HK ^{1/4}	3
Preisgr. A349 (m ²)	Preisgr. A245 (m ²)	Preisgr. A169 (m ²)	Preisgr. A150 (m ²)	Preisgr. A169 (m ²)	Preisgr. A233 (m ²)	Preisgr. A306 (m ²)	gelb mittel
701-2021H ¹	702-2021H ¹	705-2021H	710-2021H	703-2021H ^{1/4}	552021-341550HK ^{1/4}	552021-352010HK ^{1/4}	2
Preisgr. A349 (m ²)	Preisgr. A245 (m ²)	Preisgr. A169 (m ²)	Preisgr. A150 (m ²)	Preisgr. A169 (m ²)	Preisgr. A233 (m ²)	Preisgr. A306 (m ²)	gelb dunkel
701-2022H ¹	702-2022H ¹	705-2022H	710-2022H	703-2022H ¹	552022-341550HK ¹	552022-352010HK ¹	2
Preisgr. A349 (m ²)	Preisgr. A245 (m ²)	Preisgr. A169 (m ²)	Preisgr. A150 (m ²)	Preisgr. A169 (m ²)	Preisgr. A233 (m ²)	Preisgr. A306 (m ²)	ocker aktiv
701-2023H ¹	702-2023H ¹	705-2023H	710-2023H	703-2023H ¹	552023-341550HK ¹	552023-352010HK ¹	4
Preisgr. A349 (m ²)	Preisgr. A245 (m ²)	Preisgr. A169 (m ²)	Preisgr. A150 (m ²)	Preisgr. A169 (m ²)	Preisgr. A233 (m ²)	Preisgr. A306 (m ²)	ocker hell
701-2024H ¹	702-2024H ¹	705-2024H	710-2024H	703-2024H ¹	552024-341550HK ¹	552024-352010HK ¹	3
Preisgr. A349 (m ²)	Preisgr. A245 (m ²)	Preisgr. A169 (m ²)	Preisgr. A150 (m ²)	Preisgr. A169 (m ²)	Preisgr. A233 (m ²)	Preisgr. A306 (m ²)	ocker mittel
701-2025H ¹	702-2025H ¹	705-2025H	710-2025H	703-2025H ^{1/4}	552025-341550HK ^{1/4}	552025-352010HK ^{1/4}	2
Preisgr. A349 (m ²)	Preisgr. A245 (m ²)	Preisgr. A169 (m ²)	Preisgr. A150 (m ²)	Preisgr. A169 (m ²)	Preisgr. A233 (m ²)	Preisgr. A306 (m ²)	ocker dunkel
701-2026H ¹	702-2026H ¹	705-2026H	710-2026H	703-2026H ¹	552026-341550HK ¹	552026-352010HK ¹	2
Preisgr. A349 (m ²)	Preisgr. A245 (m ²)	Preisgr. A169 (m ²)	Preisgr. A150 (m ²)	Preisgr. A169 (m ²)	Preisgr. A233 (m ²)	Preisgr. A306 (m ²)	lachs aktiv
701-2027H ¹	702-2027H ¹	705-2027H	710-2027H	703-2027H ¹	552027-341550HK ¹	552027-352010HK ¹	4
Preisgr. A349 (m ²)	Preisgr. A245 (m ²)	Preisgr. A169 (m ²)	Preisgr. A150 (m ²)	Preisgr. A169 (m ²)	Preisgr. A233 (m ²)	Preisgr. A306 (m ²)	lachs hell
701-2028H ¹	702-2028H ¹	705-2028H	710-2028H	703-2028H ¹	552028-341550HK ¹	552028-352010HK ¹	3
Preisgr. A349 (m ²)	Preisgr. A245 (m ²)	Preisgr. A169 (m ²)	Preisgr. A150 (m ²)	Preisgr. A169 (m ²)	Preisgr. A233 (m ²)	Preisgr. A306 (m ²)	lachs mittel
701-2029H ¹	702-2029H ¹	705-2029H	710-2029H	703-2029H ¹	552029-341550HK ¹	552029-352010HK ¹	2
Preisgr. A349 (m ²)	Preisgr. A245 (m ²)	Preisgr. A169 (m ²)	Preisgr. A150 (m ²)	Preisgr. A169 (m ²)	Preisgr. A233 (m ²)	Preisgr. A306 (m ²)	lachs dunkel
701-2030H ¹	702-2030H ¹	705-2030H	710-2030H	703-2030H ¹	552030-341550HK ¹	552030-352010HK ¹	2
Preisgr. A349 (m ²)	Preisgr. A245 (m ²)	Preisgr. A169 (m ²)	Preisgr. A150 (m ²)	Preisgr. A169 (m ²)	Preisgr. A233 (m ²)	Preisgr. A306 (m ²)	oxidrot aktiv
701-2031H ¹	702-2031H ¹	705-2031H	710-2031H	703-2031H ¹	552031-341550HK ¹	552031-352010HK ¹	4
Preisgr. A349 (m ²)	Preisgr. A245 (m ²)	Preisgr. A169 (m ²)	Preisgr. A150 (m ²)	Preisgr. A169 (m ²)	Preisgr. A233 (m ²)	Preisgr. A306 (m ²)	oxidrot hell
701-2032H ¹	702-2032H ¹	705-2032H	710-2032H	703-2032H ¹	552032-341550HK ¹	552032-352010HK ¹	3
Preisgr. A349 (m ²)	Preisgr. A245 (m ²)	Preisgr. A169 (m ²)	Preisgr. A150 (m ²)	Preisgr. A169 (m ²)	Preisgr. A233 (m ²)	Preisgr. A306 (m ²)	oxidrot mittel
701-2033H ¹	702-2033H ¹	705-2033H	710-2033H	703-2033H ¹	552033-341550HK ¹	552033-352010HK ¹	2
Preisgr. A349 (m ²)	Preisgr. A245 (m ²)	Preisgr. A169 (m ²)	Preisgr. A150 (m ²)	Preisgr. A169 (m ²)	Preisgr. A233 (m ²)	Preisgr. A306 (m ²)	oxidrot dunkel
701-2034H ¹	702-2034H ¹	705-2034H	710-2034H	703-2034H ¹	552034-341550HK ¹	552034-352010HK ¹	2
Preisgr. A349 (m ²)	Preisgr. A245 (m ²)	Preisgr. A169 (m ²)	Preisgr. A150 (m ²)	Preisgr. A169 (m ²)	Preisgr. A233 (m ²)	Preisgr. A306 (m ²)	steingrau aktiv
701-2035H ¹	702-2035H ¹	705-2035H	710-2035H	703-2035H	552035-341550HK	552035-352010HK	4
Preisgr. A349 (m ²)	Preisgr. A245 (m ²)	Preisgr. A169 (m ²)	Preisgr. A150 (m ²)	Preisgr. A150 (m ²)	Preisgr. A205 (m ²)	Preisgr. A277 (m ²)	steingrau hell
701-2036H ¹	702-2036H	705-2036H	710-2036H	703-2036H ¹	552036-341550HK ¹	552036-352010HK ¹	3
Preisgr. A349 (m ²)	Preisgr. A245 (m ²)	Preisgr. A169 (m ²)	Preisgr. A150 (m ²)	Preisgr. A169 (m ²)	Preisgr. A233 (m ²)	Preisgr. A306 (m ²)	steingrau mittel
701-2037H ¹	702-2037H ¹	705-2037H	710-2037H	703-2037H ¹	552037-341550HK ¹	552037-352010HK ¹	2
Preisgr. A349 (m ²)	Preisgr. A245 (m ²)	Preisgr. A169 (m ²)	Preisgr. A150 (m ²)	Preisgr. A169 (m ²)	Preisgr. A233 (m ²)	Preisgr. A306 (m ²)	steingrau dunkel
701-2038H ¹	702-2038H ¹	705-2038H	710-2038H	703-2038H ¹	552038-341550HK ¹	552038-352010HK ¹	2
Preisgr. A349 (m ²)	Preisgr. A245 (m ²)	Preisgr. A169 (m ²)	Preisgr. A150 (m ²)	Preisgr. A169 (m ²)	Preisgr. A233 (m ²)	Preisgr. A306 (m ²)	sandgrau aktiv
701-2039H ¹	702-2039H ¹	705-2039H	710-2039H	703-2039H	552039-341550HK	552039-352010HK	4
Preisgr. A349 (m ²)	Preisgr. A245 (m ²)	Preisgr. A169 (m ²)	Preisgr. A150 (m ²)	Preisgr. A150 (m ²)	Preisgr. A205 (m ²)	Preisgr. A277 (m ²)	sandgrau hell
701-2040H ¹	702-2040H	705-2040H	710-2040H	703-2040H ¹	552040-341550HK ¹	552040-352010HK ¹	3
Preisgr. A349 (m ²)	Preisgr. A245 (m ²)	Preisgr. A169 (m ²)	Preisgr. A150 (m ²)	Preisgr. A169 (m ²)	Preisgr. A233 (m ²)	Preisgr. A306 (m ²)	sandgrau mittel
							2
							sandgrau dunkel

¹ Auftragsfertigung: Rückgabe und/oder Stornierung bestellter Ware nicht möglich.

² Auf Anfrage können auch definierte Farbverläufe und Mosaikbilder geliefert werden.

³ Überglasierte Kanten anteilsmäßig im Bogen

⁴ Produktionsbedingte Farbabweichung zum Standard ist möglich.

⁵ rektifiziert

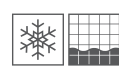

Duschassensystem: siehe Serie Plural non-slip, S. 257 ff

Boden-/Wandfliesen

15 x 15 cm



20 x 20 cm



20 x 40 cm



25 x 50 cm³



30 x 30 cm³



30 x 60 cm³



50 x 100 cm³

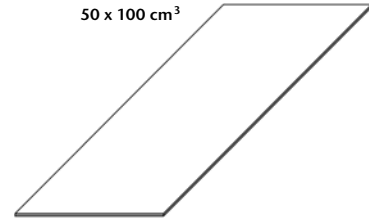

Formatnummer	15 x 15 cm	20 x 20 cm	20 x 40 cm	25 x 50 cm ³	30 x 30 cm ³	30 x 60 cm ³	50 x 100 cm ³
Nennmaß - cm/in	15 x 15 / 6 x 6	20 x 20 / 8 x 8	20 x 40 / 8 x 16	25 x 50 / 10 x 20	30 x 30 / 12 x 12	30 x 60 / 12 x 24	50 x 100 / 20 x 40
Herstellmaß	147 x 147 x 6,5 mm	197 x 197 x 6,5 mm	197 x 397 x 6,5 mm	247 x 497 x 8 mm	297 x 297 x 8 mm	297 x 597 x 8 mm	497 x 997 x 8 mm
Oberfläche	eben, OP-geeig.	eben, OP-geeig.	eben, OP-geeig.	eben, seidenmatt	eben, seidenmatt	eben, seidenmatt	eben, seidenmatt
m ² - Stück	44,000	25,000	12,500	8,000	11,111	5,556	2,000
m ² - kg	13,816	13,875	14,100	17,040	17,222	17,413	18,080
Paket - Stück	44	25	16	9	14	6	2
Paket - m ²	1,000	1,000	1,280	1,125	1,260	1,080	1,000
Paket - kg	13,816	13,875	18,048	19,170	21,700	18,804	18,080
Palette - m ²	80,000	72,000	72,960	40,500	52,921	43,197	52,000
Palette - kg	1.105,280	999,000	1.028,736	690,120	911,410	752,242	940,160
Produktnorm	Blb	Bib	Bib	Alb	Alb	Alb	Alb
Belastung	1 - 2	1 - 2	1 - 2	1 - 2	1 - 2	1 - 2	1 - 2
Beanspruchungsgruppe	2	2	2	2	2	2	2
gelb aktiv	715-2017H ¹ Preisgr. A139 (m ²)	720-2017H Preisgr. A119 (m ²)	740-2017H ¹ Preisgr. A169 (m ²)	552017-342550HK ² Preisgr. A177 (m ²)	730-2017H ^{1/2} Preisgr. A209 (m ²)	760-2017H ^{1/2} Preisgr. A209 (m ²)	552017-352050HK ^{1/2} Preisgr. A233 (m ²)
gelb hell	715-2018H Preisgr. A119 (m ²)	720-2018H Preisgr. A119 (m ²)	740-2018H Preisgr. A150 (m ²)	552018-342550HK Preisgr. A177 (m ²)	730-2018H ¹ Preisgr. A209 (m ²)	760-2018H ¹ Preisgr. A209 (m ²)	552018-352050HK ¹ Preisgr. A233 (m ²)
gelb mittel	715-2019H ¹ Preisgr. A139 (m ²)	720-2019H ¹ Preisgr. A139 (m ²)	740-2019H ¹ Preisgr. A169 (m ²)	552019-342550HK Preisgr. A177 (m ²)	730-2019H ¹ Preisgr. A209 (m ²)	760-2019H ¹ Preisgr. A209 (m ²)	552019-352050HK ¹ Preisgr. A233 (m ²)
gelb dunkel	715-2020H ¹ Preisgr. A139 (m ²)	720-2020H ¹ Preisgr. A139 (m ²)	740-2020H ¹ Preisgr. A169 (m ²)	552020-342550HK ² Preisgr. A177 (m ²)	730-2020H ^{1/2} Preisgr. A209 (m ²)	760-2020H ^{1/2} Preisgr. A209 (m ²)	552020-352050HK ^{1/2} Preisgr. A233 (m ²)
ocker aktiv	715-2021H ¹ Preisgr. A139 (m ²)	720-2021H ¹ Preisgr. A139 (m ²)	740-2021H ¹ Preisgr. A169 (m ²)	552021-342550HK ² Preisgr. A177 (m ²)	730-2021H ^{1/2} Preisgr. A209 (m ²)	760-2021H ^{1/2} Preisgr. A209 (m ²)	552021-352050HK ^{1/2} Preisgr. A233 (m ²)
ocker hell	715-2022H Preisgr. A119 (m ²)	720-2022H Preisgr. A119 (m ²)	740-2022H Preisgr. A150 (m ²)	552022-342550HK Preisgr. A177 (m ²)	730-2022H ¹ Preisgr. A209 (m ²)	760-2022H ¹ Preisgr. A209 (m ²)	552022-352050HK ¹ Preisgr. A233 (m ²)
ocker mittel	715-2023H ¹ Preisgr. A139 (m ²)	720-2023H ¹ Preisgr. A139 (m ²)	740-2023H ¹ Preisgr. A169 (m ²)	552023-342550HK Preisgr. A177 (m ²)	730-2023H ¹ Preisgr. A209 (m ²)	760-2023H ¹ Preisgr. A209 (m ²)	552023-352050HK ¹ Preisgr. A233 (m ²)
ocker dunkel	715-2024H ¹ Preisgr. A139 (m ²)	720-2024H ¹ Preisgr. A139 (m ²)	740-2024H ¹ Preisgr. A169 (m ²)	552024-342550HK Preisgr. A177 (m ²)	730-2024H ¹ Preisgr. A209 (m ²)	760-2024H ¹ Preisgr. A209 (m ²)	552024-352050HK ¹ Preisgr. A233 (m ²)
lachs aktiv	715-2025H ¹ Preisgr. A139 (m ²)	720-2025H ¹ Preisgr. A139 (m ²)	740-2025H ¹ Preisgr. A169 (m ²)	552025-342550HK ² Preisgr. A177 (m ²)	730-2025H ^{1/2} Preisgr. A209 (m ²)	760-2025H ^{1/2} Preisgr. A209 (m ²)	552025-352050HK ^{1/2} Preisgr. A233 (m ²)
lachs hell	715-2026H Preisgr. A119 (m ²)	720-2026H ¹ Preisgr. A139 (m ²)	740-2026H ¹ Preisgr. A169 (m ²)	552026-342550HK Preisgr. A177 (m ²)	730-2026H ¹ Preisgr. A209 (m ²)	760-2026H ¹ Preisgr. A209 (m ²)	552026-352050HK ¹ Preisgr. A233 (m ²)
lachs mittel	715-2027H Preisgr. A119 (m ²)	720-2027H Preisgr. A119 (m ²)	740-2027H Preisgr. A150 (m ²)	552027-342550HK Preisgr. A177 (m ²)	730-2027H ¹ Preisgr. A209 (m ²)	760-2027H ¹ Preisgr. A209 (m ²)	552027-352050HK ¹ Preisgr. A233 (m ²)
lachs dunkel	715-2028H ¹ Preisgr. A139 (m ²)	720-2028H ¹ Preisgr. A139 (m ²)	740-2028H ¹ Preisgr. A169 (m ²)	552028-342550HK Preisgr. A177 (m ²)	730-2028H ¹ Preisgr. A209 (m ²)	760-2028H ¹ Preisgr. A209 (m ²)	552028-352050HK ¹ Preisgr. A233 (m ²)
oxidrot aktiv	715-2029H ¹ Preisgr. A139 (m ²)	720-2029H ¹ Preisgr. A139 (m ²)	740-2029H ¹ Preisgr. A169 (m ²)	552029-342550HK Preisgr. A177 (m ²)	730-2029H ¹ Preisgr. A209 (m ²)	760-2029H ¹ Preisgr. A209 (m ²)	552029-352050HK ¹ Preisgr. A233 (m ²)
oxidrot hell	715-2030H ¹ Preisgr. A139 (m ²)	720-2030H ¹ Preisgr. A139 (m ²)	740-2030H ¹ Preisgr. A169 (m ²)	552030-342550HK Preisgr. A177 (m ²)	730-2030H ¹ Preisgr. A209 (m ²)	760-2030H ¹ Preisgr. A209 (m ²)	552030-352050HK ¹ Preisgr. A233 (m ²)
oxidrot mittel	715-2031H Preisgr. A119 (m ²)	720-2031H Preisgr. A119 (m ²)	740-2031H Preisgr. A150 (m ²)	552031-342550HK Preisgr. A177 (m ²)	730-2031H ¹ Preisgr. A209 (m ²)	760-2031H ¹ Preisgr. A209 (m ²)	552031-352050HK ¹ Preisgr. A233 (m ²)
oxidrot dunkel	715-2032H ¹ Preisgr. A139 (m ²)	720-2032H ¹ Preisgr. A139 (m ²)	740-2032H ¹ Preisgr. A169 (m ²)	552032-342550HK Preisgr. A177 (m ²)	730-2032H ¹ Preisgr. A209 (m ²)	760-2032H ¹ Preisgr. A209 (m ²)	552032-352050HK ¹ Preisgr. A233 (m ²)
steingrau aktiv	715-2033H ¹ Preisgr. A139 (m ²)	720-2033H ¹ Preisgr. A139 (m ²)	740-2033H ¹ Preisgr. A169 (m ²)	552033-342550HK Preisgr. A177 (m ²)	730-2033H ¹ Preisgr. A209 (m ²)	760-2033H ¹ Preisgr. A209 (m ²)	552033-352050HK ¹ Preisgr. A233 (m ²)
steingrau hell	715-2034H ¹ Preisgr. A139 (m ²)	720-2034H ¹ Preisgr. A139 (m ²)	740-2034H ¹ Preisgr. A169 (m ²)	552034-342550HK Preisgr. A177 (m ²)	730-2034H ¹ Preisgr. A209 (m ²)	760-2034H ¹ Preisgr. A209 (m ²)	552034-352050HK ¹ Preisgr. A233 (m ²)
steingrau mittel	715-2035H ¹ Preisgr. A139 (m ²)	720-2035H ¹ Preisgr. A139 (m ²)	740-2035H ¹ Preisgr. A169 (m ²)	552035-342550HK Preisgr. A177 (m ²)	730-2035H Preisgr. A177 (m ²)	760-2035H Preisgr. A177 (m ²)	552035-352050HK Preisgr. A205 (m ²)
steingrau dunkel	715-2036H Preisgr. A119 (m ²)	720-2036H Preisgr. A119 (m ²)	740-2036H Preisgr. A150 (m ²)	552036-342550HK Preisgr. A177 (m ²)	730-2036H ¹ Preisgr. A209 (m ²)	760-2036H ¹ Preisgr. A209 (m ²)	552036-352050HK ¹ Preisgr. A233 (m ²)
sandgrau aktiv	715-2037H ¹ Preisgr. A139 (m ²)	720-2037H ¹ Preisgr. A139 (m ²)	740-2037H ¹ Preisgr. A169 (m ²)	552037-342550HK Preisgr. A177 (m ²)	730-2037H ¹ Preisgr. A209 (m ²)	760-2037H ¹ Preisgr. A209 (m ²)	552037-352050HK ¹ Preisgr. A233 (m ²)
sandgrau hell	715-2038H Preisgr. A119 (m ²)	720-2038H Preisgr. A119 (m ²)	740-2038H Preisgr. A150 (m ²)	552038-342550HK Preisgr. A177 (m ²)	730-2038H ¹ Preisgr. A209 (m ²)	760-2038H ¹ Preisgr. A209 (m ²)	552038-352050HK ¹ Preisgr. A233 (m ²)
sandgrau mittel	715-2039H Preisgr. A119 (m ²)	720-2039H Preisgr. A119 (m ²)	740-2039H Preisgr. A150 (m ²)	552039-342550HK Preisgr. A177 (m ²)	730-2039H Preisgr. A177 (m ²)	760-2039H Preisgr. A177 (m ²)	552039-352050HK Preisgr. A205 (m ²)
sandgrau dunkel	715-2040H Preisgr. A119 (m ²)	720-2040H Preisgr. A119 (m ²)	740-2040H ¹ Preisgr. A169 (m ²)	552040-342550HK Preisgr. A177 (m ²)	730-2040H ¹ Preisgr. A209 (m ²)	760-2040H ¹ Preisgr. A209 (m ²)	552040-352050HK ¹ Preisgr. A233 (m ²)



¹ Auftragsfertigung: Rückgabe und/oder Stornierung bestellter Ware nicht möglich.



³ rektifiziert

² Produktionsbedingte Farbabweichung zum Standard ist möglich.

Mosaik

10 x 10 cm¹



Mosaik, rückseitig
thermoplastisch verklebt
Bogen: 297 x 297 mm



						10 x 10 / 4 x 4	Beanspruchungsgruppe	Nennmaß - cm/in
						97 x 97 x 6,5 mm		Herstellmaß
						eben, OP-geeig.		Oberfläche
						11 Bögen		m ² - Stück
						13,101		m ² - kg
						11 Bögen		Paket - Stück
						1,000		Paket - m ²
						13,101		Paket - kg
						64,000		Palette - m ²
						838,464		Palette - kg
						Bib	Produktnorm	
						1 - 2	Belastung	
						710-2504H	3	
						Preisgr. A177 (m ²)		tiefanthrazit
						710-2508H	3	
						Preisgr. A177 (m ²)		tiefblau
						710-2512H	3	
						Preisgr. A177 (m ²)		tiefgrün
						710-2516H	4	
						Preisgr. A177 (m ²)		tiefgelb
						710-2520H	4	
						Preisgr. A177 (m ²)		tieforange
						710-2524H	3	
						Preisgr. A177 (m ²)		tiefrot

¹ Überglasierte Kanten
anteilmäßig im Bogen



Kehlsockel

Innenecke zu
Kehlsockel¹

Außenecke zu
Kehlsockel¹

10 x 10 cm¹



Nennmaß - cm/in	10 x 10 / 4 x 4					
Herstellmaß	100 x 97 x 6,5 mm	100 x 18 x 6,5 mm	100 x 18 x 6,5 mm			
Oberfläche	eben, seidenmatt	eben, seidenmatt	eben, seidenmatt			
m - Stück	10,000					
m/St. - kg	1,500/m	0,030/Stück	0,030/Stück			
Paket - Stück	40	40	30			
Paket - m	4,000					
Paket - kg	6,000					
Palette - m						
Palette - kg						
Produktnorm	Bib	Bib	Bib			
neutral 10 (aktivweiß)	4 763-2120H Preisgr. A416 (St.)	759-2120H Preisgr. A430 (St.)	761-2120H Preisgr. A430 (St.)			
neutral 9 (weißgrau)	4	759-2119H Preisgr. A430 (St.)	761-2119H Preisgr. A430 (St.)			
neutral 8 (lichtgrau)	4 763-2118H Preisgr. A416 (St.)	759-2118H Preisgr. A430 (St.)	761-2118H Preisgr. A430 (St.)			
neutral 7 (kieselgrau)	4	759-2117H Preisgr. A430 (St.)	761-2117H Preisgr. A430 (St.)			
neutral 5 (basaltgrau)	3 763-2115H Preisgr. A416 (St.)	759-2115H Preisgr. A430 (St.)	761-2115H Preisgr. A430 (St.)			
neutral 3 (asphaltschwarz)	3	759-2113H Preisgr. A430 (St.)	761-2113H Preisgr. A430 (St.)			
neutral 1 (tiefschwarz)	1 763-2111H Preisgr. A430 (St.)	759-2111H Preisgr. A430 (St.)	761-2111H Preisgr. A430 (St.)			
azur aktiv	2	759-2001H Preisgr. A430 (St.)	761-2001H Preisgr. A430 (St.)			
azur hell	4	759-2002H Preisgr. A430 (St.)	761-2002H Preisgr. A430 (St.)			
azur mittel	3 763-2003H Preisgr. A416 (St.)	759-2003H Preisgr. A430 (St.)	761-2003H Preisgr. A430 (St.)			
azur dunkel	2	759-2004H Preisgr. A430 (St.)	761-2004H Preisgr. A430 (St.)			
blau hell	4	759-2006H Preisgr. A430 (St.)	761-2006H Preisgr. A430 (St.)			
blau mittel	3	759-2007H Preisgr. A430 (St.)	761-2007H Preisgr. A430 (St.)			
blau dunkel	2	759-2008H Preisgr. A430 (St.)	761-2008H Preisgr. A430 (St.)			
türkis mittel	3	759-2011H Preisgr. A430 (St.)	761-2011H Preisgr. A430 (St.)			
grün mittel	3	759-2015H Preisgr. A430 (St.)	761-2015H Preisgr. A430 (St.)			
grün dunkel	2	759-2016H Preisgr. A430 (St.)	761-2016H Preisgr. A430 (St.)			
gelb mittel	3	759-2019H Preisgr. A430 (St.)	761-2019H Preisgr. A430 (St.)			
ocker mittel	3	759-2023H Preisgr. A430 (St.)	761-2023H Preisgr. A430 (St.)			
lachs mittel	3	759-2027H Preisgr. A430 (St.)	761-2027H Preisgr. A430 (St.)			
oxidrot mittel	3	759-2031H Preisgr. A430 (St.)	761-2031H Preisgr. A430 (St.)			
steingrau hell	4 763-2034H Preisgr. A416 (St.)	759-2034H Preisgr. A430 (St.)	761-2034H Preisgr. A430 (St.)			
steingrau dunkel	2 763-2036H Preisgr. A416 (St.)	759-2036H Preisgr. A430 (St.)	761-2036H Preisgr. A430 (St.)			
sandgrau aktiv	2 763-2037H Preisgr. A416 (St.)	759-2037H Preisgr. A430 (St.)	761-2037H Preisgr. A430 (St.)			
sandgrau dunkel	2 763-2040H Preisgr. A416 (St.)	759-2040H Preisgr. A430 (St.)	761-2040H Preisgr. A430 (St.)			

¹ Details siehe S. 483



Duschassensystem: siehe Serie Plural non-slip, S. 257 ff



Projekt: Explorer Hotel / Standort: St. Johann, Österreich / Architekt: Camp Innenarchitektur / Serie: Plural / Foto: Roland Reuter, Absam





Projekt: Gisela Schule / Standort: Passau, Deutschland / Architekt: Feigel, Huber, Dumps /
Serie: Plural non-slip / Foto: Michael Christian Peters







neutral 10 (aktivweiß)	azur dunkel	azur mittel	azur hell	azur aktiv
neutral 9 (weißgrau)	blau dunkel	blau mittel	blau hell	blau aktiv
neutral 8 (lichtgrau)	türkis dunkel	türkis mittel	türkis hell	türkis aktiv
neutral 7 (kieselgrau)	grün dunkel	grün mittel	grün hell	grün aktiv
neutral 6 (perlgrau)	gelb dunkel	gelb mittel	gelb hell	gelb aktiv
neutral 5 (basaltgrau)	ocker dunkel	ocker mittel	ocker hell	ocker aktiv
neutral 4 (graphitschwarz)	lachs dunkel	lachs mittel	lachs hell	lachs aktiv
neutral 3 (asphaltschwarz)	oxidrot dunkel	oxidrot mittel	oxidrot hell	oxidrot aktiv
neutral 2 (anthrazit)	steingrau dunkel	steingrau mittel	steingrau hell	steingrau aktiv
neutral 1 (tiefschwarz)	sandgrau dunkel	sandgrau mittel	sandgrau hell	sandgrau aktiv

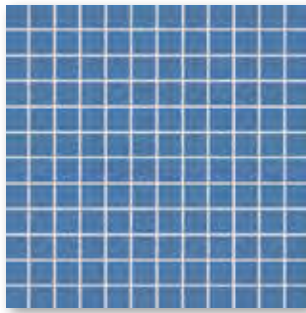

Mosaik 2,5 x 2,5 cm



Kehlsockel, trittsicher
10 x 10 cm



Duschtassensystem Ecke,
trittsicher, 10 x 10 cm



Innenecke
eben



Außenecke
eben



Duschtassensystem Läufer
trittsicher, 10 x 10 cm

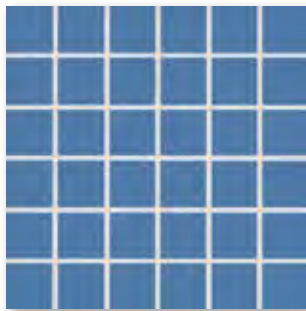

Mosaik 5 x 5 cm

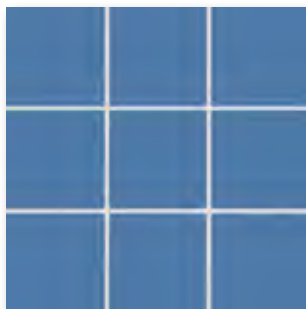

Mosaik 10 x 10 cm

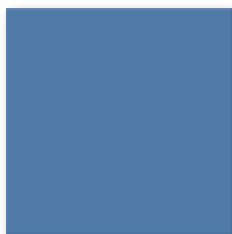

Bodenfliese
20 x 20 cm

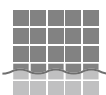

Rückseitig thermoplastisch verklebte Mosaik von AGROB BUCHTAL sind nicht nur im Trockenbereich, sondern auch bedenkenlos im Unterwasserbereich (z. B. Schwimmbecken/Whirlpool) sowie im dauernassbelasteten Bereich (z. B. Beckenumgänge/Duschen) einsetzbar.

Mosaik

Wand-/Bodenfliesen

2,5 x 2,5 cm

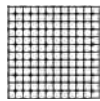

Mosaik, rückseitig
thermoplastisch verklebt
Bogen: 297 x 297 mm

5 x 5 cm

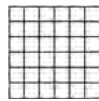

Mosaik, rückseitig
thermoplastisch verklebt
Bogen: 297 x 297 mm

10 x 10 cm

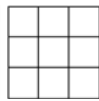

Mosaik, rückseitig
thermoplastisch verklebt
Bogen: 297 x 297 mm

20 x 20 cm



Nennmaß - cm/in	2,5 x 2,5 / 1 x 1	5 x 5 / 2 x 2	10 x 10 / 4 x 4	20 x 20 / 8 x 8			
Herstellmaß	23 x 23 x 6,5 mm	47 x 47 x 6,5 mm	97 x 97 x 6,5 mm	197 x 197 x 6,5 mm			
Oberfläche	eben, matt	eben, matt	eben, matt	eben, matt			
m ² - Stück	11 Bögen	11 Bögen	11 Bögen	25,000			
m ² - kg	12,100	12,331	13,101	13,875			
Paket - Stück	11 Bögen	11 Bögen	11 Bögen	25			
Paket - m ²	1,000	1,000	1,000	1,000			
Paket - kg	12,100	12,331	13,101	13,875			
Palette - m ²	48,000	64,000	64,000	72,000			
Palette - kg	580,800	789,184	838,464	999,000			
Produktnorm	Bib	Bib	Bib	Bib			
Trittsicherheit	R10/B	R10/B	R10/B	R10/B			
Belastung	1 - 2	1 - 2	1 - 2	1 - 2			
neutral 10 (aktivweiß)	4 902-2120H Preisgr. A216 (m ²)	905-2120H Preisgr. A169 (m ²)	910-2120H Preisgr. A157 (m ²)	920-2120H Preisgr. A125 (m ²)			
neutral 9 (weißgrau)	4 902-2119H¹ Preisgr. A271 (m ²)	905-2119H¹ Preisgr. A241 (m ²)	910-2119H Preisgr. A184 (m ²)	920-2119H¹ Preisgr. A177 (m ²)			
neutral 8 (lichtgrau)	4 902-2118H Preisgr. A216 (m ²)	905-2118H Preisgr. A169 (m ²)	910-2118H Preisgr. A157 (m ²)	920-2118H Preisgr. A125 (m ²)			
neutral 7 (kieselgrau)	4 902-2117H¹ Preisgr. A271 (m ²)	905-2117H¹ Preisgr. A241 (m ²)	910-2117H Preisgr. A184 (m ²)	920-2117H¹ Preisgr. A177 (m ²)			
neutral 6 (perlgrau)	3 902-2116H¹ Preisgr. A271 (m ²)	905-2116H¹ Preisgr. A241 (m ²)	910-2116H¹ Preisgr. A216 (m ²)	920-2116H¹ Preisgr. A177 (m ²)			
neutral 5 (basaltgrau)	3 902-2115H¹ Preisgr. A271 (m ²)	905-2115H¹ Preisgr. A241 (m ²)	910-2115H Preisgr. A184 (m ²)	920-2115H Preisgr. A157 (m ²)			
neutral 4 (graphitschwarz)	3 902-2114H¹ Preisgr. A271 (m ²)	905-2114H¹ Preisgr. A241 (m ²)	910-2114H Preisgr. A184 (m ²)	920-2114H Preisgr. A157 (m ²)			
neutral 3 (asphaltschwarz)	3 902-2113H¹ Preisgr. A271 (m ²)	905-2113H¹ Preisgr. A241 (m ²)	910-2113H Preisgr. A184 (m ²)	920-2113H¹ Preisgr. A177 (m ²)			
neutral 2 (anthrazit)	2 902-2112H¹ Preisgr. A271 (m ²)	905-2112H¹ Preisgr. A241 (m ²)	910-2112H Preisgr. A184 (m ²)	920-2112H Preisgr. A157 (m ²)			
neutral 1 (tiefschwarz)	1 902-2111H Preisgr. A239 (m ²)	905-2111H Preisgr. A192 (m ²)	910-2111H Preisgr. A184 (m ²)	920-2111H Preisgr. A157 (m ²)			
azur aktiv	2 902-2001H¹ Preisgr. A271 (m ²)	905-2001H¹ Preisgr. A241 (m ²)	910-2001H Preisgr. A184 (m ²)	920-2001H¹ Preisgr. A177 (m ²)			
azur hell	4 902-2002H¹ Preisgr. A271 (m ²)	905-2002H¹ Preisgr. A241 (m ²)	910-2002H Preisgr. A184 (m ²)	920-2002H¹ Preisgr. A177 (m ²)			
azur mittel	3 902-2003H Preisgr. A239 (m ²)	905-2003H Preisgr. A192 (m ²)	910-2003H Preisgr. A184 (m ²)	920-2003H Preisgr. A157 (m ²)			
azur dunkel	2 902-2004H Preisgr. A239 (m ²)	905-2004H¹ Preisgr. A241 (m ²)	910-2004H Preisgr. A184 (m ²)	920-2004H Preisgr. A157 (m ²)			
blau aktiv	2 902-2005H¹ Preisgr. A271 (m ²)	905-2005H¹ Preisgr. A241 (m ²)	910-2005H¹ Preisgr. A216 (m ²)	920-2005H¹ Preisgr. A177 (m ²)			
blau hell	4 902-2006H¹ Preisgr. A271 (m ²)	905-2006H¹ Preisgr. A241 (m ²)	910-2006H Preisgr. A184 (m ²)	920-2006H¹ Preisgr. A177 (m ²)			
blau mittel	3 902-2007H¹ Preisgr. A271 (m ²)	905-2007H¹ Preisgr. A241 (m ²)	910-2007H Preisgr. A184 (m ²)	920-2007H Preisgr. A157 (m ²)			
blau dunkel	2 902-2008H Preisgr. A239 (m ²)	905-2008H Preisgr. A192 (m ²)	910-2008H Preisgr. A184 (m ²)	920-2008H Preisgr. A157 (m ²)			
türkis aktiv	2 902-2009H¹ Preisgr. A271 (m ²)	905-2009H¹ Preisgr. A241 (m ²)	910-2009H¹ Preisgr. A216 (m ²)	920-2009H¹ Preisgr. A177 (m ²)			
türkis hell	4 902-2010H¹ Preisgr. A271 (m ²)	905-2010H¹ Preisgr. A241 (m ²)	910-2010H¹ Preisgr. A216 (m ²)	920-2010H¹ Preisgr. A177 (m ²)			
türkis mittel	3 902-2011H¹ Preisgr. A271 (m ²)	905-2011H¹ Preisgr. A241 (m ²)	910-2011H Preisgr. A184 (m ²)	920-2011H Preisgr. A157 (m ²)			
türkis dunkel	2 902-2012H¹ Preisgr. A271 (m ²)	905-2012H¹ Preisgr. A241 (m ²)	910-2012H¹ Preisgr. A216 (m ²)	920-2012H¹ Preisgr. A177 (m ²)			
grün aktiv	2 902-2013H¹ Preisgr. A271 (m ²)	905-2013H¹ Preisgr. A241 (m ²)	910-2013H¹ Preisgr. A216 (m ²)	920-2013H¹ Preisgr. A177 (m ²)			
grün hell	4 902-2014H¹ Preisgr. A271 (m ²)	905-2014H Preisgr. A192 (m ²)	910-2014H¹ Preisgr. A216 (m ²)	920-2014H¹ Preisgr. A177 (m ²)			
grün mittel	3 902-2015H¹ Preisgr. A271 (m ²)	905-2015H¹ Preisgr. A241 (m ²)	910-2015H Preisgr. A184 (m ²)	920-2015H Preisgr. A157 (m ²)			
grün dunkel	2 902-2016H¹ Preisgr. A271 (m ²)	905-2016H¹ Preisgr. A241 (m ²)	910-2016H Preisgr. A184 (m ²)	920-2016H Preisgr. A157 (m ²)			



¹ Auftragsfertigung: Rückgabe und/oder Stornierung bestellter Ware nicht möglich.

Kehlsockel Innenecke zu Kehlsockel¹ Außenecke zu Kehlsockel¹ Duschtassensystem

10 x 10 cm^{1/2}



10 x 10 cm¹



10 x 10 cm¹



		Läufer			Ecke		Beanspruchungsgruppe	Nennmaß - cm/in
	10 x 10 / 4 x 4	100 x 18 x 6,5 mm	100 x 18 x 6,5 mm	100 x 18 x 6,5 mm	10 x 10 / 4 x 4	10 x 10 / 4 x 4		
	100 x 97 x 6,5 mm	100 x 97 x 6,5 mm	100 x 97 x 6,5 mm	100 x 97 x 6,5 mm	97 x 97 x 6,5 mm	97 x 97 x 6,5 mm		Oberfläche
	eben, matt	eben, matt	eben, matt	eben, matt	eben, matt	eben, matt		m - Stück
	10,000				10,000			m/St. - kg
	1,500/m	0,030/Stück	0,030/Stück	0,030/Stück	1,700/m	0,170/Stück		Paket - Stück
	40	40	30	30	16	4		Paket - m
	4,000				1,600			Paket - kg
	6,000				2,720	0,680		Palette - m
								Palette - kg
	Bib	Bib	Bib	Bib	Bib	Bib		Produktnorm
	R10/B				R10/B	R10/B		Trittsicherheit
	764-2120H	759-2120H	761-2120H	761-2120H	785-2120H	786-2120H	4	neutral 10
	Preisgr. A418 (St.)	Preisgr. A430 (St.)	Preisgr. A430 (St.)	Preisgr. A430 (St.)	Preisgr. A428 (St.)	Preisgr. A455 (St.)		(aktivweiß)
	764-2119H	759-2119H	761-2119H	761-2119H	785-2119H	786-2119H	4	neutral 9
	Preisgr. A418 (St.)	Preisgr. A430 (St.)	Preisgr. A430 (St.)	Preisgr. A430 (St.)	Preisgr. A428 (St.)	Preisgr. A455 (St.)		(weißgrau)
	764-2118H	759-2118H	761-2118H	761-2118H	785-2118H	786-2118H	4	neutral 8
	Preisgr. A418 (St.)	Preisgr. A430 (St.)	Preisgr. A430 (St.)	Preisgr. A430 (St.)	Preisgr. A428 (St.)	Preisgr. A455 (St.)		(lichtgrau)
	764-2117H	759-2117H	761-2117H	761-2117H	785-2117H	786-2117H	4	neutral 7
	Preisgr. A418 (St.)	Preisgr. A430 (St.)	Preisgr. A430 (St.)	Preisgr. A430 (St.)	Preisgr. A428 (St.)	Preisgr. A455 (St.)		(kieselgrau)
	764-2115H	759-2115H	761-2115H	761-2115H	785-2115H	786-2115H	3	neutral 5
	Preisgr. A418 (St.)	Preisgr. A430 (St.)	Preisgr. A430 (St.)	Preisgr. A430 (St.)	Preisgr. A428 (St.)	Preisgr. A455 (St.)		(basaltgrau)
	764-2113H	759-2113H	761-2113H	761-2113H	785-2113H	786-2113H	3	neutral 3
	Preisgr. A418 (St.)	Preisgr. A430 (St.)	Preisgr. A430 (St.)	Preisgr. A430 (St.)	Preisgr. A428 (St.)	Preisgr. A455 (St.)		(asphaltschwarz)
	764-2111H	759-2111H	761-2111H	761-2111H	785-2111H	786-2111H	1	neutral 1
	Preisgr. A418 (St.)	Preisgr. A430 (St.)	Preisgr. A430 (St.)	Preisgr. A430 (St.)	Preisgr. A428 (St.)	Preisgr. A455 (St.)		(tiefschwarz)
	764-2001H	759-2001H	761-2001H	761-2001H	785-2001H	786-2001H	2	azur aktiv
	Preisgr. A418 (St.)	Preisgr. A430 (St.)	Preisgr. A430 (St.)	Preisgr. A430 (St.)	Preisgr. A428 (St.)	Preisgr. A455 (St.)		
	764-2002H	759-2002H	761-2002H	761-2002H	785-2002H	786-2002H	4	azur hell
	Preisgr. A418 (St.)	Preisgr. A430 (St.)	Preisgr. A430 (St.)	Preisgr. A430 (St.)	Preisgr. A428 (St.)	Preisgr. A455 (St.)		
	764-2003H	759-2003H	761-2003H	761-2003H	785-2003H	786-2003H	3	azur mittel
	Preisgr. A418 (St.)	Preisgr. A430 (St.)	Preisgr. A430 (St.)	Preisgr. A430 (St.)	Preisgr. A428 (St.)	Preisgr. A455 (St.)		
	764-2004H	759-2004H	761-2004H	761-2004H	785-2004H	786-2004H	2	azur dunkel
	Preisgr. A418 (St.)	Preisgr. A430 (St.)	Preisgr. A430 (St.)	Preisgr. A430 (St.)	Preisgr. A428 (St.)	Preisgr. A455 (St.)		
	764-2006H	759-2006H	761-2006H	761-2006H	785-2006H	786-2006H	4	blau hell
	Preisgr. A418 (St.)	Preisgr. A430 (St.)	Preisgr. A430 (St.)	Preisgr. A430 (St.)	Preisgr. A428 (St.)	Preisgr. A455 (St.)		
	764-2007H	759-2007H	761-2007H	761-2007H	785-2007H	786-2007H	3	blau mittel
	Preisgr. A418 (St.)	Preisgr. A430 (St.)	Preisgr. A430 (St.)	Preisgr. A430 (St.)	Preisgr. A428 (St.)	Preisgr. A455 (St.)		
	764-2008H	759-2008H	761-2008H	761-2008H	785-2008H	786-2008H	2	blau dunkel
	Preisgr. A418 (St.)	Preisgr. A430 (St.)	Preisgr. A430 (St.)	Preisgr. A430 (St.)	Preisgr. A428 (St.)	Preisgr. A455 (St.)		
	764-2011H	759-2011H	761-2011H	761-2011H	785-2011H	786-2011H	3	türkis mittel
	Preisgr. A418 (St.)	Preisgr. A430 (St.)	Preisgr. A430 (St.)	Preisgr. A430 (St.)	Preisgr. A428 (St.)	Preisgr. A455 (St.)		
	764-2015H	759-2015H	761-2015H	761-2015H	785-2015H	786-2015H	3	grün mittel
	Preisgr. A418 (St.)	Preisgr. A430 (St.)	Preisgr. A430 (St.)	Preisgr. A430 (St.)	Preisgr. A428 (St.)	Preisgr. A455 (St.)		
	764-2016H	759-2016H	761-2016H	761-2016H	785-2016H	786-2016H	2	grün dunkel
	Preisgr. A418 (St.)	Preisgr. A430 (St.)	Preisgr. A430 (St.)	Preisgr. A430 (St.)	Preisgr. A428 (St.)	Preisgr. A455 (St.)		

¹ Details siehe S. 483 ff



Mosaik

Wand-/Bodenfliesen

2,5 x 2,5 cm

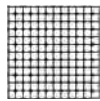

Mosaik, rückseitig
thermoplastisch verklebt
Bogen: 297 x 297 mm

5 x 5 cm

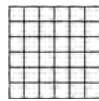

Mosaik, rückseitig
thermoplastisch verklebt
Bogen: 297 x 297 mm

10 x 10 cm

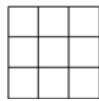

Mosaik, rückseitig
thermoplastisch verklebt
Bogen: 297 x 297 mm

20 x 20 cm



Nennmaß - cm/in	2,5 x 2,5 / 1 x 1	5 x 5 / 2 x 2	10 x 10 / 4 x 4	20 x 20 / 8 x 8		
Herstellmaß	23 x 23 x 6,5 mm	47 x 47 x 6,5 mm	97 x 97 x 6,5 mm	197 x 197 x 6,5 mm		
Oberfläche	eben, matt	eben, matt	eben, matt	eben, matt		
m ² - Stück	11 Bögen	11 Bögen	11 Bögen	25,000		
m ² - kg	12,100	12,331	13,101	13,875		
Paket - Stück	11 Bögen	11 Bögen	11 Bögen	25		
Paket - m ²	1,000	1,000	1,000	1,000		
Paket - kg	12,100	12,331	13,101	13,875		
Palette - m ²	48,000	64,000	64,000	72,000		
Palette - kg	580,800	789,184	838,464	999,000		
Produktnorm	Bib	Bib	Bib	Bib		
Trittsicherheit	R10/B	R10/B	R10/B	R10/B		
Belastung	1 - 2	1 - 2	1 - 2	1 - 2		
gelb aktiv	2 902-2017H ¹ Preisgr. A271 (m ²)	905-2017H ¹ Preisgr. A241 (m ²)	910-2017H ¹ Preisgr. A216 (m ²)	920-2017H ¹ Preisgr. A177 (m ²)		
gelb hell	4 902-2018H ¹ Preisgr. A271 (m ²)	905-2018H ¹ Preisgr. A241 (m ²)	910-2018H ¹ Preisgr. A216 (m ²)	920-2018H ¹ Preisgr. A177 (m ²)		
gelb mittel	3 902-2019H ¹ Preisgr. A271 (m ²)	905-2019H ¹ Preisgr. A241 (m ²)	910-2019H Preisgr. A184 (m ²)	920-2019H Preisgr. A157 (m ²)		
gelb dunkel	2 902-2020H ¹ Preisgr. A271 (m ²)	905-2020H ¹ Preisgr. A241 (m ²)	910-2020H ¹ Preisgr. A216 (m ²)	920-2020H ¹ Preisgr. A177 (m ²)		
ocker aktiv	2 902-2021H ¹ Preisgr. A271 (m ²)	905-2021H ¹ Preisgr. A241 (m ²)	910-2021H ¹ Preisgr. A216 (m ²)	920-2021H ¹ Preisgr. A177 (m ²)		
ocker hell	4 902-2022H ¹ Preisgr. A271 (m ²)	905-2022H ¹ Preisgr. A241 (m ²)	910-2022H Preisgr. A184 (m ²)	920-2022H ¹ Preisgr. A177 (m ²)		
ocker mittel	3 902-2023H ¹ Preisgr. A271 (m ²)	905-2023H ¹ Preisgr. A241 (m ²)	910-2023H Preisgr. A184 (m ²)	920-2023H Preisgr. A157 (m ²)		
ocker dunkel	2 902-2024H ¹ Preisgr. A271 (m ²)	905-2024H ¹ Preisgr. A241 (m ²)	910-2024H ¹ Preisgr. A216 (m ²)	920-2024H ¹ Preisgr. A177 (m ²)		
lachs aktiv	2 902-2025H ¹ Preisgr. A271 (m ²)	905-2025H ¹ Preisgr. A241 (m ²)	910-2025H ¹ Preisgr. A216 (m ²)	920-2025H ¹ Preisgr. A177 (m ²)		
lachs hell	4 902-2026H ¹ Preisgr. A271 (m ²)	905-2026H ¹ Preisgr. A241 (m ²)	910-2026H ¹ Preisgr. A216 (m ²)	920-2026H ¹ Preisgr. A177 (m ²)		
lachs mittel	3 902-2027H ¹ Preisgr. A271 (m ²)	905-2027H ¹ Preisgr. A192 (m ²)	910-2027H Preisgr. A184 (m ²)	920-2027H Preisgr. A157 (m ²)		
lachs dunkel	2 902-2028H ¹ Preisgr. A271 (m ²)	905-2028H ¹ Preisgr. A241 (m ²)	910-2028H ¹ Preisgr. A216 (m ²)	920-2028H Preisgr. A157 (m ²)		
oxidrot aktiv	2 902-2029H ¹ Preisgr. A271 (m ²)	905-2029H Preisgr. A192 (m ²)	910-2029H ¹ Preisgr. A216 (m ²)	920-2029H ¹ Preisgr. A177 (m ²)		
oxidrot hell	4 902-2030H ¹ Preisgr. A271 (m ²)	905-2030H ¹ Preisgr. A241 (m ²)	910-2030H ¹ Preisgr. A216 (m ²)	920-2030H ¹ Preisgr. A177 (m ²)		
oxidrot mittel	3 902-2031H ¹ Preisgr. A271 (m ²)	905-2031H ¹ Preisgr. A241 (m ²)	910-2031H Preisgr. A184 (m ²)	920-2031H Preisgr. A157 (m ²)		
oxidrot dunkel	2 902-2032H ¹ Preisgr. A271 (m ²)	905-2032H ¹ Preisgr. A241 (m ²)	910-2032H ¹ Preisgr. A216 (m ²)	920-2032H ¹ Preisgr. A177 (m ²)		
steingrau aktiv	2 902-2033H ¹ Preisgr. A271 (m ²)	905-2033H ¹ Preisgr. A241 (m ²)	910-2033H Preisgr. A184 (m ²)	920-2033H ¹ Preisgr. A177 (m ²)		
steingrau hell	4 902-2034H ¹ Preisgr. A271 (m ²)	905-2034H ¹ Preisgr. A241 (m ²)	910-2034H Preisgr. A184 (m ²)	920-2034H ¹ Preisgr. A177 (m ²)		
steingrau mittel	3 902-2035H ¹ Preisgr. A271 (m ²)	905-2035H ¹ Preisgr. A241 (m ²)	910-2035H Preisgr. A184 (m ²)	920-2035H Preisgr. A177 (m ²)		
steingrau dunkel	2 902-2036H Preisgr. A239 (m ²)	905-2036H Preisgr. A192 (m ²)	910-2036H Preisgr. A184 (m ²)	920-2036H Preisgr. A157 (m ²)		
sandgrau aktiv	2 902-2037H ¹ Preisgr. A271 (m ²)	905-2037H ¹ Preisgr. A241 (m ²)	910-2037H Preisgr. A184 (m ²)	920-2037H ¹ Preisgr. A177 (m ²)		
sandgrau hell	4 902-2038H ¹ Preisgr. A271 (m ²)	905-2038H Preisgr. A192 (m ²)	910-2038H Preisgr. A184 (m ²)	920-2038H Preisgr. A157 (m ²)		
sandgrau mittel	3 902-2039H ¹ Preisgr. A271 (m ²)	905-2039H Preisgr. A192 (m ²)	910-2039H Preisgr. A184 (m ²)	920-2039H Preisgr. A157 (m ²)		
sandgrau dunkel	2 902-2040H Preisgr. A239 (m ²)	905-2040H Preisgr. A192 (m ²)	910-2040H Preisgr. A184 (m ²)	920-2040H Preisgr. A157 (m ²)		



¹ Auftragsfertigung: Rückgabe und/oder Stormierung bestellter Ware nicht möglich.

Kehlsockel Innenecke zu Kehlsockel¹ Außenecke zu Kehlsockel¹ Duschtassensystem

10 x 10 cm¹



10 x 10 cm¹



10 x 10 cm¹



		Läufer			Ecke		Beanspruchungsgruppe	Nennmaß - cm/in Herstellmaß Oberfläche m - Stück m/St. - kg Paket - Stück Paket - m Paket - kg Palette - m Palette - kg Produktnorm Trittsicherheit
	10 x 10 / 4 x 4	100 x 18 x 6,5 mm	100 x 18 x 6,5 mm	100 x 18 x 6,5 mm	10 x 10 / 4 x 4	10 x 10 / 4 x 4		
	100 x 97 x 6,5 mm eben, matt 10,000 1,500/m 40 4,000 6,000	eben, matt 0,030/Stück 40	eben, matt 0,030/Stück 30	eben, matt 1,700/m 16 1,600 2,720	eben, matt 0,170/Stück 4 0,680			
	Blb R10/B	Blb	Blb	Blb R10/B	Blb R10/B			
	764-2019H Preisgr. A418 (St.)	759-2019H Preisgr. A430 (St.)	761-2019H Preisgr. A430 (St.)	785-2019H Preisgr. A428 (St.)	786-2019H Preisgr. A455 (St.)	3	gelb mittel	
	764-2023H Preisgr. A418 (St.)	759-2023H Preisgr. A430 (St.)	761-2023H Preisgr. A430 (St.)	785-2023H Preisgr. A428 (St.)	786-2023H Preisgr. A455 (St.)	3	ocker mittel	
	764-2027H Preisgr. A418 (St.)	759-2027H Preisgr. A430 (St.)	761-2027H Preisgr. A430 (St.)	785-2027H Preisgr. A428 (St.)	786-2027H Preisgr. A455 (St.)	3	lachs mittel	
	764-2031H Preisgr. A418 (St.)	759-2031H Preisgr. A430 (St.)	761-2031H Preisgr. A430 (St.)	785-2031H Preisgr. A428 (St.)	786-2031H Preisgr. A455 (St.)	3	oxidrot mittel	
	764-2034H Preisgr. A418 (St.)	759-2034H Preisgr. A430 (St.)	761-2034H Preisgr. A430 (St.)	785-2034H Preisgr. A428 (St.)	786-2034H Preisgr. A455 (St.)	4	steingrau hell	
	764-2036H Preisgr. A418 (St.)	759-2036H Preisgr. A430 (St.)	761-2036H Preisgr. A430 (St.)	785-2036H Preisgr. A428 (St.)	786-2036H Preisgr. A455 (St.)	2	steingrau dunkel	
	764-2037H Preisgr. A418 (St.)	759-2037H Preisgr. A430 (St.)	761-2037H Preisgr. A430 (St.)	785-2037H Preisgr. A428 (St.)	786-2037H Preisgr. A455 (St.)	2	sandgrau aktiv	
	764-2040H Preisgr. A418 (St.)	759-2040H Preisgr. A430 (St.)	761-2040H Preisgr. A430 (St.)	785-2040H Preisgr. A428 (St.)	786-2040H Preisgr. A455 (St.)	2	sandgrau dunkel	

¹ Details siehe Seite 483 ff



260 PLURAL UNGLASIERT

Projekt: Hauswirtschaftsschule / Standort: Sankt Gallen, Schweiz / Architekt: Architekturbüro Daniel Cavelti /
Serie: Plural unglasiert / Foto: Adriano Faragulo







R10/B R11/C



blau dunkel



grün dunkel



ocker mittel



steingrau aktiv



sandweiß



sandgrau mittel



sandgrau dunkel



braun mittel



grau mittel



sandbeige mittel



neutral 1 (tiefschwarz)



neutral 3 (asphaltschwarz)

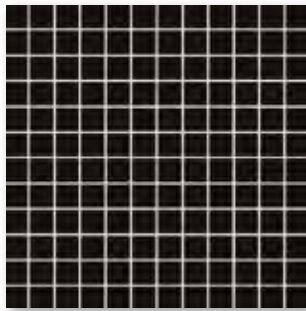

Mosaik, eben, matt, R10/B
2,5 x 2,5 cm



Bodenfliese, eben, matt, R10/B
15 x 15 cm



Kehlsockel, eben, matt
10 x 10 cm

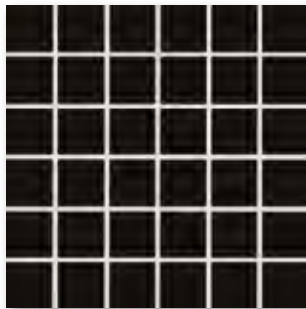

Mosaik, eben, matt, R10/B
5 x 5 cm



Bodenfliese, reliefiert, matt, R11/C
15 x 15 cm



Duschtassensystem Ecke,
eben, matt, 10 x 10 cm



Bodenfliese, eben, matt, R10/B
20 x 20 cm



Duschtassensystem Läufer
eben, matt, 10 x 10 cm

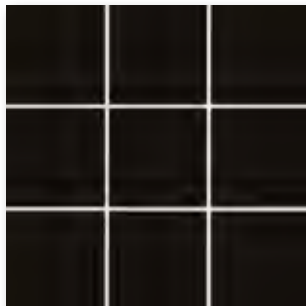

Mosaik, eben, matt, R10/B
10 x 10 cm

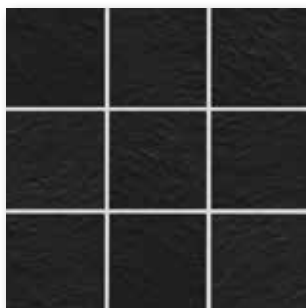

Mosaik, reliefiert, matt, R11/C
10 x 10 cm

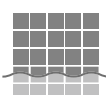

Rückseitig thermoplastisch verklebte Mosaik von AGROB BUCHTAL sind nicht nur im Trockenbereich, sondern auch bedenkenlos im Unterwasserbereich (z. B. Schwimmbecken/Whirlpool) sowie im dauernassbelasteten Bereich (z. B. Beckenumgänge/Duschen) einsetzbar.

Mosaik

2,5 x 2,5 cm



Mosaik, rückseitig
thermoplastisch verklebt
Bogen: 297 x 297 mm

5 x 5 cm



Mosaik, rückseitig
thermoplastisch verklebt
Bogen: 297 x 297 mm

10 x 10 cm



Mosaik, rückseitig
thermoplastisch verklebt
Bogen: 297 x 297 mm

10 x 10 cm



Mosaik, rückseitig
thermoplastisch verklebt
Bogen: 297 x 297 mm

Bodenfliesen

15 x 15 cm



15 x 15 cm



Nennmaß - cm/in	2,5 x 2,5 / 1 x 1	5 x 5 / 2 x 2	10 x 10 / 4 x 4	10 x 10 / 4 x 4	15 x 15 / 6 x 6	15 x 15 / 6 x 6	
Herstellmaß	23 x 23 x 6,5 mm	47 x 47 x 6,5 mm	97 x 97 x 6,5 mm	97 x 97 x 6,5 mm	147 x 147 x 6,5 mm	147 x 147 x 6,5 mm	
Oberfläche	eben, matt	eben, matt	eben, matt	reliefiert, matt	eben, matt	reliefiert, matt	
m ² - Stück	11 Bögen	11 Bögen	11 Bögen	11 Bögen	44,000	44,000	
m ² - kg	12,100	12,331	13,101	13,101	13,816	13,816	
Paket - Stück	11 Bögen	11 Bögen	11 Bögen	11 Bögen	44	44	
Paket - m ²	1,000	1,000	1,000	1,000	1,000	1,000	
Paket - kg	12,100	12,331	13,101	13,101	13,816	13,816	
Palette - m ²	48,000	64,000	64,000	64,000	80,000	80,000	
Palette - kg	580,800	789,184	838,464	838,464	1.105,280	1.105,280	
Produktnorm	Bla	Bla	Bla	Bla	Bla	Bla	
Trittsicherheit	R10/B	R10/B	R10/B	R11/C	R10/B	R11/C	
Belastung	1 - 2	1 - 2	1 - 2	1 - 2	1 - 2	1 - 2	
neutral 3 (asphaltschwarz)	410-2113 Preisgr. A177 (m ²)	610-2113 Preisgr. A150 (m ²)	810-2113 Preisgr. A101 (m ²)	811-2113 Preisgr. A139 (m ²)	812-2113 Preisgr. A94 (m ²)	813-2113 Preisgr. A119 (m ²)	
neutral 1 (tiefschwarz)	410-2111 Preisgr. A177 (m ²)	610-2111 Preisgr. A150 (m ²)	810-2111 Preisgr. A101 (m ²)	811-2111 Preisgr. A139 (m ²)	812-2111 Preisgr. A94 (m ²)	813-2111 Preisgr. A119 (m ²)	
blau dunkel	410-2008 Preisgr. A222 (m ²)	610-2008 Preisgr. A184 (m ²)	810-2008 Preisgr. A150 (m ²)				
grün dunkel		610-2016 Preisgr. A184 (m ²)	810-2016 Preisgr. A150 (m ²)				
ocker mittel	410-2023 Preisgr. A222 (m ²)	610-2023 Preisgr. A184 (m ²)	810-2023 Preisgr. A150 (m ²)				
steingrau aktiv		610-2033 Preisgr. A184 (m ²)	810-2033 Preisgr. A150 (m ²)				
sandweiß	410-2038 Preisgr. A177 (m ²)	610-2038 Preisgr. A150 (m ²)	810-2038 Preisgr. A101 (m ²)	811-2038 Preisgr. A139 (m ²)	812-2038 Preisgr. A94 (m ²)	813-2038 Preisgr. A119 (m ²)	
sandgrau mittel	410-2039 Preisgr. A177 (m ²)	610-2039 Preisgr. A150 (m ²)	810-2039 Preisgr. A101 (m ²)				
sandgrau dunkel	410-2040 Preisgr. A177 (m ²)	610-2040 Preisgr. A150 (m ²)	810-2040 Preisgr. A101 (m ²)				
braun mittel	410-2041 Preisgr. A222 (m ²)	610-2041 Preisgr. A184 (m ²)	810-2041 Preisgr. A150 (m ²)				
grau mittel	410-2042 Preisgr. A222 (m ²)	610-2042 Preisgr. A184 (m ²)	810-2042 Preisgr. A150 (m ²)	811-2042 Preisgr. A157 (m ²)	812-2042 Preisgr. A125 (m ²)	813-2042 Preisgr. A150 (m ²)	
sandbeige mittel	410-2043 Preisgr. A222 (m ²)	610-2043 Preisgr. A184 (m ²)	810-2043 Preisgr. A150 (m ²)				



Bodenfliesen Kehlsockel Duschtassensystem

20 x 20 cm



10 x 10 cm



10 x 10 cm¹



10 x 10 cm¹



protected

					Läufer	Ecke	
			20 x 20 / 8 x 8	10 x 10 / 4 x 4	10 x 10 / 4 x 4	10 x 10 / 4 x 4	Nennmaß - cm/in
			197 x 197 x 6,5 mm	100 x 97 x 6,5 mm	97 x 97 x 6,5 mm	97 x 97 x 6,5 mm	Herstellmaß
			eben, matt	eben, matt	eben, matt	eben, matt	Oberfläche
			25,000/m ²	10,000/m	10,000/m		m ² /m - Stück
			13,875/m ²	1,500/m	1,700/m	0,170/Stück	m ² /m/St. - kg
			25	40	16	4	Paket - Stück
			1,000 m ²	4,000 m	1,600 m		Paket - m ² /m
			13,875	6,000	2,720	0,680	Paket - kg
			72,000				Palette - m ²
			999,000				Palette - kg
			Bla	Bla	Bla	Bla	Produktnorm
			R10/B	R10/B	R10/B	R10/B	Trittsicherheit
			1 - 2				Belastung
			815-2113	864-2113	885-2113	886-2113	neutral 3
			Preisgr. A81 (m ²)	Preisgr. A419 (St.)	Preisgr. A445 (St.)	Preisgr. A475 (St.)	(asphaltschwarz)
			815-2111	864-2111	885-2111	886-2111	neutral 1
			Preisgr. A81 (m ²)	Preisgr. A419 (St.)	Preisgr. A445 (St.)	Preisgr. A475 (St.)	(tiefschwarz)
			815-2008	864-2008	885-2008	886-2008	blau dunkel
			Preisgr. A119 (m ²)	Preisgr. A419 (St.)	Preisgr. A445 (St.)	Preisgr. A475 (St.)	
				864-2016			grün dunkel
				Preisgr. A419 (St.)			
			815-2023	864-2023	885-2023	886-2023	ocker mittel
			Preisgr. A119 (m ²)	Preisgr. A419 (St.)	Preisgr. A445 (St.)	Preisgr. A475 (St.)	
				864-2033			steingrau aktiv
				Preisgr. A419 (St.)			
			815-2038	864-2038	885-2038	886-2038	sandweiß
			Preisgr. A81 (m ²)	Preisgr. A419 (St.)	Preisgr. A445 (St.)	Preisgr. A475 (St.)	
			815-2039	864-2039	885-2039	886-2039	sandgrau mittel
			Preisgr. A81 (m ²)	Preisgr. A419 (St.)	Preisgr. A445 (St.)	Preisgr. A475 (St.)	
			815-2040	864-2040	885-2040	886-2040	sandgrau dunkel
			Preisgr. A81 (m ²)	Preisgr. A419 (St.)	Preisgr. A445 (St.)	Preisgr. A475 (St.)	
			815-2041	864-2041	885-2041	886-2041	braun mittel
			Preisgr. A119 (m ²)	Preisgr. A419 (St.)	Preisgr. A445 (St.)	Preisgr. A475 (St.)	
			815-2042	864-2042	885-2042	886-2042	grau mittel
			Preisgr. A119 (m ²)	Preisgr. A419 (St.)	Preisgr. A445 (St.)	Preisgr. A475 (St.)	
			815-2043	864-2043	885-2043	886-2043	sandbeige mittel
			Preisgr. A119 (m ²)	Preisgr. A419 (St.)	Preisgr. A445 (St.)	Preisgr. A475 (St.)	

¹ Details siehe S. 483 ff





Projekt: August-Köhler-Kinderhaus / Standort: Gotha, Deutschland / Architekt: Architekturbüro Dipl. Ing. Arch. Matthias Wohlleben /
Serie: Plural Kids / Foto: Jochen Stüber





Unten im Meer,
20 x 20 cm
5er-Set



Set-Art. Nr.: 212121

Hoch hinaus,
20 x 20 cm
5er-Set



Set-Art. Nr.: 212120

Mondreise,
20 x 20 cm
5er-Set



Set-Art. Nr.: 212122

Kinder unserer Welt,
20 x 20 cm
5er-Set



Set-Art. Nr.: 212124

Orientexpress, 20 x 20 cm
5er-Set



Set-Art. Nr.: 212123

Tierisches Alphabet,
20 x 20 cm

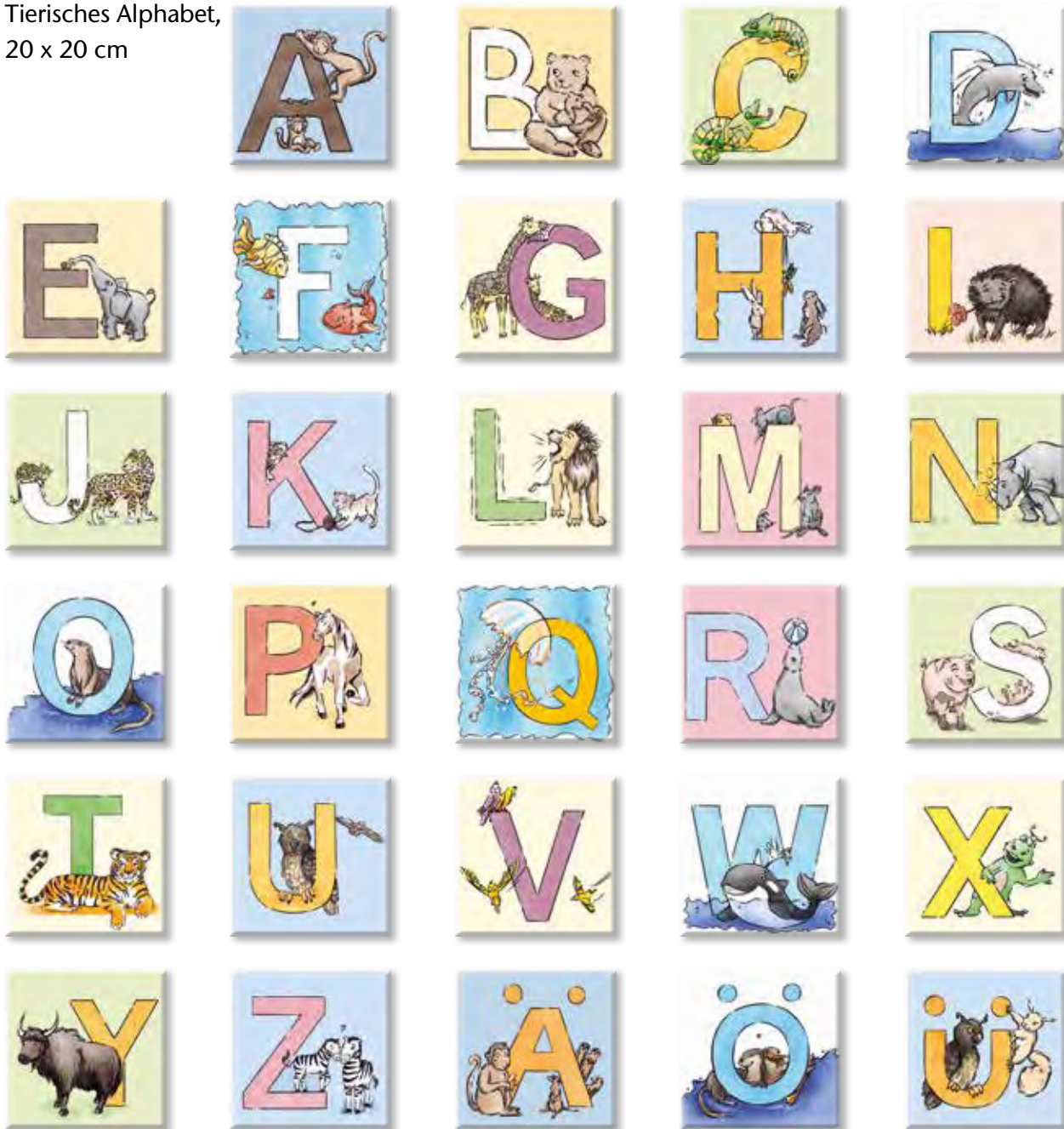

Zahlen mit Tieren,
20 x 20 cm



Art. Nr.: 212142 Gleiche Artikelnummer für Buchstaben und Zahlen. Bitte bei Bestellung zusätzlich Buchstaben bzw. Zahl angeben.



20 x 20 cm



20 x 20 cm

Zahlen +
Buchstaben

Ser-Set

	Zahlen + Buchstaben	Ser-Set				
Nennmaß - cm/in	20 x 20 / 8 x 8	20 x 20 / 8 x 8				
Herstellmaß	197 x 197 x 6,5 mm	197 x 197 x 6,5 mm				
Oberfläche	eben, glänzend	eben, glänzend				
m - Stück	5,000	5,000				
m - kg	2,240	2,240				
Paket - Stück	1 VE = 5 St.	1 Set = 5 St.				
Paket - m	0,200	2,000				
Paket - kg	0,448	2,240				
Palette - m						
Palette - kg						
Produktnorm	BIII	BIII				
Kids		212120				
hoch hinaus		Preisgr. A539 (Set)				
Kids		212121				
unten im Meer		Preisgr. A539 (Set)				
Kids		212122				
Mondreise		Preisgr. A539 (Set)				
Kids		212123				
Orientexpress		Preisgr. A539 (Set)				
Kids		212124				
Kinder unserer Welt		Preisgr. A539 (Set)				
Zahlen + Buchstaben	212142 ¹ Preisgr. A438 (St.)					

¹ Gleiche Artikelnummer für Zahlen und Buchstaben.
 Bitte bei Bestellung zusätzlich Buchstaben bzw. Zahl angeben.



Projekt: August-Köhler-Kinderhaus / Standort: Gotha, Deutschland / Architekt: Architekturbüro Dipl. Ing. Arch. Matthias Wohlleben / Serie: Plural Kids / Foto: Jochen Stüber







Natürlich und lebhaft

Natürlich in der Anmutung, überzeugt Quarzit durch ungewöhnliche Eigenschaften, die auf einem neuartigen Glasurverfahren beruhen. Dabei wird die mit einem Granulat angereicherte Glasur aufgebracht und geht beim Brand eine innige Verbindung mit dem Fliesenkörper ein. So ergibt sich eine durch dezente Glanz- und Glimmerpunkte lebendig nuancierte Oberfläche in authentischer Steinoptik. Zu den ästhetischen Vorzügen kommen praktische hinzu: Angenehme Haptik verbindet sich mit hoher Trittsicherheit und enormer Verschleißfestigkeit.



R10/A R11/B R11/C C



basaltgrau



quarzgrau



sandbeige

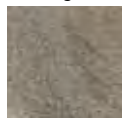

sepiabraun



weißgrau



Bodenfliese 12,5 x 12,5 cm

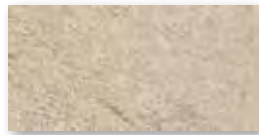

Bodenfliese 12,5 x 25 cm



Rasterprofilfliese 12,5 x 25 cm

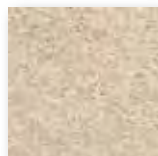

Bodenfliese 15 x 15 cm



Bodenfliese 25 x 25 cm

Mosaik 5 x 5 cm



Mosaikbogen 5 x 5 cm,
trittsicher R11/B



Bodenfliese 25 x 50 cm



Bodenfliese 30 x 60 cm



Bodenfliese 60 x 60 cm, Terrassenplatte 60 x 60 cm



Treppenfliese mit Schräge 31 x 135 cm



Setzstufe 28 x 135 cm



R10/A R11/B R11/C C



basaltgrau

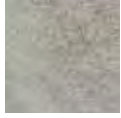

quarzgrau



sandbeige



sepiabraun



weißgrau



Schriftplatte 25 x 50 cm



Sockel geschnitten 6 x 50 cm

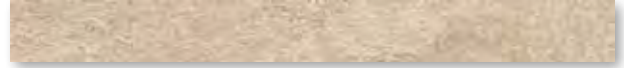

Sockel geschnitten 6 x 60 cm



Kehlsockel, dekoriert 10 x 60 cm



Rillenplatte 50 x 25 cm

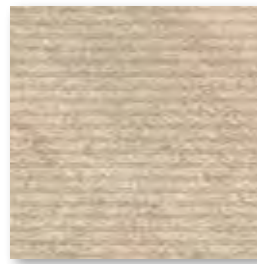

Rillenplatte 25 x 25 cm

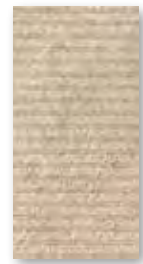

Rillenplatte 12,5 x 25 cm



Rasterprofilfliese
25 x 50 cm

Flachrinnensystem
(Muldentiefe 5 mm)



Flachrinne*
25 x 50 cm

Keramische Rinnenabdeckung*
25 x 50 cm



Keramische Rinnenabdeckung*,
Ecklösung 30 x 30 cm



*Details siehe Kapitel Pool + Spa; Keramische Rinnenabdeckung 2.0, Seite 439, (auftragsbezogene Fertigung).

ohne Abbildung:
Rinnenstein mit Ablauf,
Gehrungspaar, Endstück

Bodenfliesen 3 mm Fuge

5 x 5 cm¹



15 x 15 cm



25 x 25 cm¹



25 x 25 cm¹



25 x 50 cm¹



25 x 50 cm¹



25 x 50 cm^{1/3}



Mosaik, Verklebung
rückseitig auf
Glasfasernetz
Bogen: 297 x 297 mm

Rasterprofilfliese

7161H	342030H	332050HK	332050HK	342550HK	342550HK	342580HK	Formatnummer
5 x 5 / 2 x 2	15 x 15 / 6 x 6	25 x 25 / 10 x 10	25 x 25 / 10 x 10	25 x 50 / 10 x 20	25 x 50 / 10 x 20	25 x 50 / 10 x 20	Nennmaß - cm/in
47 x 47 x 8 mm	147 x 147 x 8 mm	247 x 247 x 8 mm	247 x 247 x 8 mm	247 x 497 x 8 mm	247 x 497 x 8 mm	247 x 497 x 8 mm	Herstellmaß
strukturiert, matt	strukturiert, matt	strukturiert, matt	strukturiert, matt	strukturiert, matt	strukturiert, matt	reliefiert, matt	Oberfläche
11,111	44,444	16,000	16,000	8,000	8,000	8,000	m ² - Stück
16,389	17,555	16,960	16,960	17,040	17,040	17,040	m ² - kg
14	35	14	14	9	9	9	Paket - Stück
1,260	0,788	0,875	0,875	1,125	1,125	1,125	Paket - m ²
20,650	13,825	14,840	14,840	19,170	19,170	19,170	Paket - kg
37,800	63,001	70,875	70,875	40,500	40,500	40,500	Palette - m ²
619,500	1.106,000	1.202,040	1.202,040	690,120	690,120	690,120	Palette - kg
Alb	Bla	Alb	Alb	Alb	Alb	Alb	Produktnorm
R11/B	R11/C	R10/A	R11/B	R10/A	R11/B	-/C	Trittsicherheit
2	2	2	2	2	2	2	Belastung
8460-7161H	8460-342030H	8450-332050HK	8460-332050HK	8450-342550HK	8460-342550HK	8460-342580HK	basaltgrau
Preisgr. A271 (m ²)	Preisgr. A125 (m ²)	Preisgr. A110 (m ²)	Preisgr. A125 (m ²)	Preisgr. A125 (m ²)	Preisgr. A139 (m ²)	Preisgr. A155 (m ²)	
8461-7161H	8461-342030H	8451-332050HK	8461-332050HK	8451-342550HK	8461-342550HK	8461-342580HK	quarzgrau
Preisgr. A271 (m ²)	Preisgr. A125 (m ²)	Preisgr. A110 (m ²)	Preisgr. A125 (m ²)	Preisgr. A125 (m ²)	Preisgr. A139 (m ²)	Preisgr. A155 (m ²)	
8462-7161H	8462-342030H	8452-332050HK	8462-332050HK	8452-342550HK	8462-342550HK	8462-342580HK	sandbeige
Preisgr. A271 (m ²)	Preisgr. A125 (m ²)	Preisgr. A110 (m ²)	Preisgr. A125 (m ²)	Preisgr. A125 (m ²)	Preisgr. A139 (m ²)	Preisgr. A155 (m ²)	
8463-7161H	8463-342030H	8453-332050HK	8463-332050HK	8453-342550HK	8463-342550HK	8463-342580HK	sepiabraun
Preisgr. A271 (m ²)	Preisgr. A125 (m ²)	Preisgr. A110 (m ²)	Preisgr. A125 (m ²)	Preisgr. A125 (m ²)	Preisgr. A139 (m ²)	Preisgr. A155 (m ²)	
8464-7161H	8464-342030H	8454-332050HK	8464-332050HK	8454-342550HK	8464-342550HK	8464-342580HK	weißgrau
Preisgr. A271 (m ²)	Preisgr. A125 (m ²)	Preisgr. A110 (m ²)	Preisgr. A125 (m ²)	Preisgr. A125 (m ²)	Preisgr. A139 (m ²)	Preisgr. A155 (m ²)	

Bodenfliesen 3 mm Fuge

30 x 60 cm¹



30 x 60 cm¹



60 x 60 cm¹



12,5 x 12,5 cm



12,5 x 25 cm



12,5 x 25 cm³



Lieferung als Doppel-
fliesen; müssen örtlich
gebrochen werden

Rasterprofilfliese

B200HK	B200HK	B600HK	32020H	38110H	34090H	Formatnummer
30 x 60 / 12 x 24	30 x 60 / 12 x 24	60 x 60 / 24 x 24	12,5 x 12,5 / 5 x 5	12,5 x 25 / 5 x 10	12,5 x 25 / 5 x 10	Nennmaß - cm/in
297 x 597 x 8 mm	297 x 597 x 8 mm	597 x 597 x 8 mm	119 x 119 x 8 mm	119 x 244 x 8 mm	119 x 244 x 8 mm	Herstellmaß
strukturiert, matt	strukturiert, matt	strukturiert, matt	strukturiert, matt	strukturiert, matt	reliefiert, matt	Oberfläche
5,556	5,556	2,778	64,000	32,000	32,000	m ² - Stück
17,413	17,413	18,001	15,360	15,680	15,360	m ² - kg
6	6	4	66	33	33	Paket - Stück
1,080	1,080	1,440	1,031	1,031	1,031	Paket - m ²
18,804	18,804	25,920	15,840	16,170	15,840	Paket - kg
43,197	43,197	43,197	86,625	86,625	86,625	Palette - m ²
752,160	752,160	777,600	1.330,560	1.358,200	1.330,560	Palette - kg
Alb	Alb	Alb	Alb	Alb	Alb	Produktnorm
R10/A	R11/B	R10/A	R11/B	R11/B	-/C	Trittsicherheit
2	2	2	2	2	2	Belastung
8450-B200HK	8460-B200HK	8450-B600HK	8460-32020H	8460-38110H	8460-34090H	basaltgrau
Preisgr. A119 (m ²)	Preisgr. A139 (m ²)	Preisgr. A139 (m ²)	Preisgr. A125 (m ²)	Preisgr. A94 (m ²)	Preisgr. A110 (m ²)	
8451-B200HK	8461-B200HK	8451-B600HK	8461-32020H	8461-38110H	8461-34090H	quarzgrau
Preisgr. A119 (m ²)	Preisgr. A139 (m ²)	Preisgr. A139 (m ²)	Preisgr. A125 (m ²)	Preisgr. A94 (m ²)	Preisgr. A110 (m ²)	
8452-B200HK	8462-B200HK	8452-B600HK	8462-32020H	8462-38110H	8462-34090H	sandbeige
Preisgr. A119 (m ²)	Preisgr. A139 (m ²)	Preisgr. A139 (m ²)	Preisgr. A125 (m ²)	Preisgr. A94 (m ²)	Preisgr. A110 (m ²)	
8453-B200HK	8463-B200HK	8453-B600HK	8463-32020H	8463-38110H	8463-34090H	sepiabraun
Preisgr. A119 (m ²)	Preisgr. A139 (m ²)	Preisgr. A139 (m ²)	Preisgr. A125 (m ²)	Preisgr. A94 (m ²)	Preisgr. A110 (m ²)	
8454-B200HK	8464-B200HK	8454-B600HK	8464-32020H	8464-38110H	8464-34090H	weißgrau
Preisgr. A119 (m ²)	Preisgr. A139 (m ²)	Preisgr. A139 (m ²)	Preisgr. A125 (m ²)	Preisgr. A94 (m ²)	Preisgr. A110 (m ²)	

¹ rektifiziert

Alle Produkte: Color Shade Variation V4

³ Auftragsfertigung: Rückgabe und/oder Stornierung
bestellter Ware nicht möglich.

Treppenfliese mit Schräge

31 x 135 cm^{2/3}



Setzstufe

28 x 135 cm^{2/3}



Sockel, geschnitten

6 x 50 cm¹



6 x 60 cm¹



Kehlsockel, dekoriert²

10 x 60 cm¹



Schriftplatte
1/2/4

25 x 50 cm

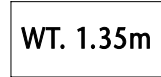

WT. 1.35m



Schrifthöhe 7 cm

Formatnummer	B775HK	B776HK	342557HK	B611HK	B612HK		342555HK
Nennmaß - cm/in	31 x 135 / 12 13/64 x 53 5/32	28 x 135 / 11 x 53 5/32	6 x 50 / 2 3/8 x 20	6 x 60 / 2 3/8 x 24	10 x 60 / 4 x 24		25 x 50 / 10 x 20
Herstellmaß	307 x 1347 x 10,5 mm	280 x 1347 x 10,5 mm	60 x 497 x 8 mm	60 x 597 x 8 mm	100 x 597/35 x 9 mm		247 x 497 x 8 mm
Oberfläche	strukturiert, matt	strukturiert, matt	strukturiert, matt	strukturiert, matt	strukturiert, matt		strukturiert, matt
m - Stück	0,741	0,741	2,000	1,667	1,667		2
St./m - kg	7,321/m	6,676/m	1,098/m	1,100/m	2,000/m		2,13/Stück
Paket - Stück	2	2	30	34	20		
Paket - m	2,699	2,699	15,000	20,396	11,998		
Paket - kg	19,760	18,020	16,470	22,440	24,000		
Palette - m							
Palette - kg							
Produktnorm	Alb	Alb	Alb	Alb	Alb		Alb
Trittsicherheit	R10/A	R10/A					R11/B
Belastung	2 - 3	2 - 3					
basaltgrau	8450-B775HK Preisgr. A560 (St.)	8450-B776HK Preisgr. A528 (St.)	8450-342557HK Preisgr. A434 (St.)	8450-B611HK Preisgr. A434 (St.)	8450-B612HK Preisgr. A445 (St.)		900725-342555HK Preisgr. A668 (St.)
quarzgrau	8451-B775HK Preisgr. A560 (St.)	8451-B776HK Preisgr. A528 (St.)	8451-342557HK Preisgr. A434 (St.)	8451-B611HK Preisgr. A434 (St.)	8451-B612HK Preisgr. A445 (St.)		900726-342555HK Preisgr. A668 (St.)
sandbeige	8452-B775HK Preisgr. A560 (St.)	8452-B776HK Preisgr. A528 (St.)	8452-342557HK Preisgr. A434 (St.)	8452-B611HK Preisgr. A434 (St.)	8452-B612HK Preisgr. A445 (St.)		900713-342555HK Preisgr. A668 (St.)
sepiabraun	8453-B775HK Preisgr. A560 (St.)	8453-B776HK Preisgr. A528 (St.)	8453-342557HK Preisgr. A434 (St.)	8453-B611HK Preisgr. A434 (St.)	8453-B612HK Preisgr. A445 (St.)		900714-342555HK Preisgr. A668 (St.)
weißgrau	8454-B775HK Preisgr. A560 (St.)	8454-B776HK Preisgr. A528 (St.)	8454-342557HK Preisgr. A434 (St.)	8454-B611HK Preisgr. A434 (St.)	8454-B612HK Preisgr. A445 (St.)		900719-342555HK Preisgr. A668 (St.)



¹ rektifiziert



² Auftragsfertigung: Rückgabe und/oder Stornierung bestellter Ware nicht möglich.



Alle Produkte: Color Shade Variation V4

³ Nur an den zwei kurzen Seiten rektifiziert! Längsseite kann nicht rektifiziert werden!

⁴ Nur Ziffern/Buchstaben machbar.

Farbkombination:

Grundfarbe: basaltgrau, quarzgrau, sandbeige, sepiabraun, Schriftfarbe: aktivweiß / neutral 10.

Grundfarbe: weißgrau, Schriftfarbe: tiefschwarz/neutral 1.

Terrassenplatten^{1/4} **NEU**

60 x 60 cm

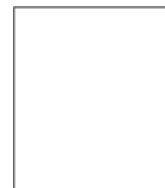

						61061HK	Formatnummer
						60 x 60 / 24 x 24	Nennmaß - cm/in
						597 x 597 x 20 mm	Herstellmaß mm
						strukturiert, matt	Oberfläche
						2,778	m ² - Stück
						43,059	m ² - kg
						1	Paket - Stück
						0,360	Paket - m ²
						15,500	Paket - kg
						17,280	Palette - m ²
						744,000	Palette - kg
						Alla	Produktnorm
						R11/B	Trittsicherheit
						3 - 4	Belastung
						8460-61061HK	4
						Preisgr. A139 (m ²)	basaltgrau
						8461-61061HK	4
						Preisgr. A139 (m ²)	quarzgrau
						8462-61061HK	4
						Preisgr. A139 (m ²)	sandbeige



⁴ Hohes Gewicht!
Karton bitte nur zu Zweit transportieren!



Flachrinnensystem²
(Muldentiefe 5 mm)

25 x 50 cm



Flachrinne

25 x 50 cm

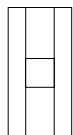

Flachrinne mit Ablauf
110 / 110 mm

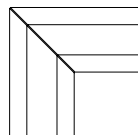

Flachrinne
Gehrungspaar

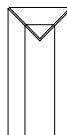

Flachrinne Endstück

50 x 25 cm

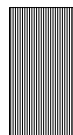

gerillt

25 x 25 cm



gerillt

12,5 x 25 cm



gerillt

53320	53321	53322	53323	53151	53150	53159	Formatnummer	
25 x 50 / 10 x 20	25 x 50 / 10 x 20			50 x 25 / 20 x 10	25 x 25 / 10 x 10	12,5 x 25 / 5 x 10	Nennmaß - cm/in	
244 x 494 x 14	244 x 494 x 14	(2x) 487 x 244 x 14	244 x 494 x 14	494 x 244 x 12,5	244 x 244 x 12,5	119 x 244 x 12,5	Herstellmaß mm	
strukturiert, matt	strukturiert, matt	strukturiert, matt	strukturiert, matt	eben, matt	eben, matt	eben, matt	Oberfläche	
2,000				2,000	4,000	8,000	m - Stück	
5.000/m	2,300/Stück	3,800/Paar	2,500/Stück	3,550/Stück	1,775/Stück	0,888/Stück	m/St./Paar - kg	
5 Stück	5 Stück	2 Paar	5 Stück	6 Stück	9 Stück	21 Stück	Paket - St./Paar	
2,500				3,000	2,250	2,625	Paket - m	
12,500	11,500	7,600	12,500	21,300	15,975	18,648	Paket - kg	
							Palette - m	
							Palette - kg	
Alb	Alb	Alb	Alb	Alb	Alb	Alb	Produktnorm	
R11/B	R11/B	R11/B	R11/B	-/C	-/C	-/C	Trittsicherheit	
8460-53320	8460-53321	8460-53322	8460-53323	8460-53151	8460-53150	8460-53159	basaltgrau	
Preisgr. A519 (St.)	Preisgr. A593 (St.)	Preisgr. A645 (Paar)	Preisgr. A593 (St.)	Preisgr. A560 (St.)	Preisgr. A480 (St.)	Preisgr. A430 (St.)		
8461-53320	8461-53321	8461-53322	8461-53323	8461-53151	8461-53150	8461-53159	quarzgrau	
Preisgr. A519 (St.)	Preisgr. A593 (St.)	Preisgr. A645 (Paar)	Preisgr. A593 (St.)	Preisgr. A560 (St.)	Preisgr. A480 (St.)	Preisgr. A430 (St.)		
8462-53320	8462-53321	8462-53322	8462-53323	8462-53151	8462-53150	8462-53159	sandbeige	
Preisgr. A519 (St.)	Preisgr. A593 (St.)	Preisgr. A645 (Paar)	Preisgr. A593 (St.)	Preisgr. A560 (St.)	Preisgr. A480 (St.)	Preisgr. A430 (St.)		
8463-53320	8463-53321	8463-53322	8463-53323	8463-53151	8463-53150	8463-53159	sepiabraun	
Preisgr. A519 (St.)	Preisgr. A593 (St.)	Preisgr. A645 (Paar)	Preisgr. A593 (St.)	Preisgr. A560 (St.)	Preisgr. A480 (St.)	Preisgr. A430 (St.)		
8464-53320	8464-53321	8464-53322	8464-53323	8464-53151	8464-53150	8464-53159	weißgrau	
Preisgr. A519 (St.)	Preisgr. A593 (St.)	Preisgr. A645 (Paar)	Preisgr. A593 (St.)	Preisgr. A560 (St.)	Preisgr. A480 (St.)	Preisgr. A430 (St.)		



² Auf Anfrage auch in 497 mm Länge machbar.

Alle Produkte: Color Shade Variation V4

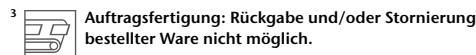





Elegant und zeitlos

Strukturen und Farben verschiedener Gesteine aus der italienischen Küstenregion „Cinque Terre“ verschmelzen in der Bodenfliesenserie Savona zu einer lebendigen Komposition aus grobkörniger Maserung und weichen Schichtungen. Fein dosierter Granulatauftrag verleiht der Oberfläche eine angenehm steinige Optik und Haptik. Glimmerartige Glanzpunkte unterstreichen die natürliche Wirkung.



R10/A R11/B R11/C



kalk

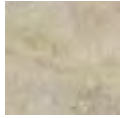

beige

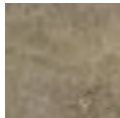

braun

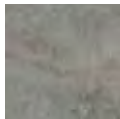

grau



anthrazit



Bodenfliese 15 x 15 cm



Bodenfliese 30 x 60 cm



Bodenfliese 60 x 60 cm

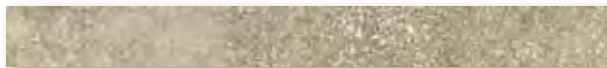

Sockel geschnitten 6 x 60 cm

Mosaik 5 x 5 cm

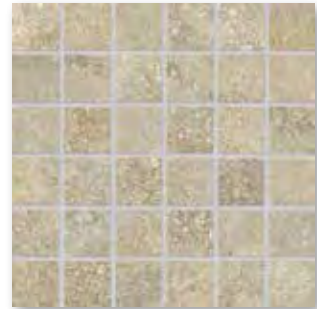

Mosaikbogen 5 x 5 cm,
trittsicher R11/B



Bodenfliese 60 x 120 cm



*Waschtisch SURF® large 55 x 120 cm (auf Anfrage lieferbar).
Weitere Informationen zu Surf auf Seite 293.*

Mosaik

Bodenfliesen

5 x 5 cm¹



15 x 15 cm



30 x 60 cm¹



30 x 60 cm¹



60 x 60 cm¹



60 x 60 cm¹

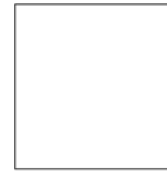

60 x 120 cm¹

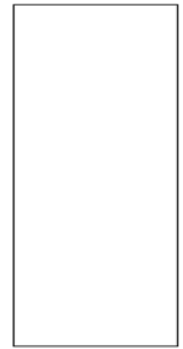

Mosaik, Verklebung rückseitig auf Glasfasernetz
Bogen: 297 x 297 mm

Formatnummer	7161H	342030H	B200HK	B200HK	B600HK	B600HK	B670HK
Nennmaß - cm/in	5 x 5 / 2 x 2	15 x 15 / 6 x 6	30 x 60 / 12 x 24	30 x 60 / 12 x 24	60 x 60 / 24 x 24	60 x 60 / 24 x 24	60 x 120 / 24 x 48
Herstellmaß	47 x 47 x 8 mm	147 x 147 x 8 mm	297 x 597 x 8 mm	297 x 597 x 8 mm	597 x 597 x 8 mm	597 x 597 x 8 mm	597 x 1197 x 8 mm
Oberfläche	strukturiert, matt	strukturiert, matt	strukturiert, matt	strukturiert, matt	strukturiert, matt	strukturiert, matt	strukturiert, matt
m ² - Stück	11,111	44,444	5,556	5,556	2,778	2,778	1,388
m ² - kg	16,389	17,555	17,413	17,413	18,001	18,001	17,489
Paket - Stück	14	35	6	6	4	4	2
Paket - m ²	1,260	0,788	1,080	1,080	1,440	1,440	1,441
Paket - kg	20,650	13,825	18,804	18,804	25,920	25,920	25,200
Palette - m ²	37,800	63,001	43,197	43,197	43,197	43,197	36,023
Palette - kg	619,500	1.106,000	752,160	752,160	777,600	777,600	630,000
Produktnorm	Alb	Bla	Alb	Alb	Alb	Alb	Alb
Trittsicherheit	R11/B	R11/C	R10/A	R11/B	R10/A	R11/B	R10/A
Belastung	2	2	2	2	2	2	2
kalk	8810-7161H Preisgr. A271 (m ²)	8810-342030H Preisgr. A125 (m ²)	8800-B200HK Preisgr. A119 (m ²)	8810-B200HK Preisgr. A125 (m ²)	8800-B600HK Preisgr. A139 (m ²)	8810-B600HK Preisgr. A155 (m ²)	8800-B670HK Preisgr. A155 (m ²)
beige	8811-7161H Preisgr. A271 (m ²)	8811-342030H Preisgr. A125 (m ²)	8801-B200HK Preisgr. A119 (m ²)	8811-B200HK Preisgr. A125 (m ²)	8801-B600HK Preisgr. A139 (m ²)	8811-B600HK Preisgr. A155 (m ²)	8801-B670HK Preisgr. A155 (m ²)
braun	8812-7161H Preisgr. A271 (m ²)	8812-342030H Preisgr. A125 (m ²)	8802-B200HK Preisgr. A119 (m ²)	8812-B200HK Preisgr. A125 (m ²)	8802-B600HK Preisgr. A139 (m ²)	8812-B600HK Preisgr. A155 (m ²)	8802-B670HK Preisgr. A155 (m ²)
grau	8813-7161H Preisgr. A271 (m ²)	8813-342030H Preisgr. A125 (m ²)	8803-B200HK Preisgr. A119 (m ²)	8813-B200HK Preisgr. A125 (m ²)	8803-B600HK Preisgr. A139 (m ²)	8813-B600HK Preisgr. A155 (m ²)	8803-B670HK Preisgr. A155 (m ²)
anthrazit	8814-7161H Preisgr. A271 (m ²)	8814-342030H Preisgr. A125 (m ²)	8804-B200HK Preisgr. A119 (m ²)	8814-B200HK Preisgr. A125 (m ²)	8804-B600HK Preisgr. A139 (m ²)	8814-B600HK Preisgr. A155 (m ²)	8804-B670HK Preisgr. A155 (m ²)



Sockel, geschnitten

6 x 60 cm¹



Formatnummer	B611HK						
Nennmaß - cm/in	6 x 60 / 2 3/8 x 24						
Herstellmaß	60 x 597 x 8 mm						
Oberfläche	strukturiert, matt						
m - Stück	1,667						
m - kg	1,100						
Paket - Stück	34						
Paket - m	20,396						
Paket - kg	22,440						
Palette - m							
Palette - kg							
Produktnorm	Alb						
kalk	8800-B611HK Preisgr. A434 (St.)						
beige	8801-B611HK Preisgr. A434 (St.)						
braun	8802-B611HK Preisgr. A434 (St.)						
grau	8803-B611HK Preisgr. A434 (St.)						
anthrazit	8804-B611HK Preisgr. A434 (St.)						



¹ rektifiziert

Alle Produkte: Color Shade Variation V4

Studioaufnahme / Architekt: VSBL, Belgrad, Serbien / Serie: Savona / Foto: Jochen Stüber





Studioaufnahme / Architekten: VSBL, Belgrad, Serbien / Serie: Streetlife / Foto: Jochen Stüber





Cool und urban

Asphalt prägt das Bild städtischer Straßen und Plätze. Und er verleiht der Bodenfliese Streetlife ihre durch und durch urbane Anmutung. Die typischen Merkmale wie körnige Strukturen, kleine Unebenheiten und Risstexturen ergeben einen ebenso zeitlosen wie markanten Bodenbelag, der mit einer Stärke von 10,5 mm speziell für öffentliche Anwendungen konzipiert wurde. Einsatzbereiche könnten Hotels, Schulen, Bürogebäude und moderner Ladenbau sein.



rost



Bodenfliese 60 x 60 cm



Bodenfliese 60 x 90 cm



Bodenfliese 60 x 120 cm



Treppenfiese 30 x 120 cm (rilliert)



Sockel, geschnitten 6 x 60 cm

Bodenfliesen

Treppenfliesen

Sockel, geschnitten

60 x 60 cm¹



60 x 90 cm¹ **NEU**



60 x 120 cm¹



30 x 120 cm^{1/2}



6 x 60 cm¹



Formatnummer	B700HK	B755HK	B770HK	B729HK	B710HK		
Nennmaß - cm/in	60 x 60 / 24 x 24	60 x 90 / 24 x 36	60 x 120 / 24 x 48	30 x 120 / 12 x 48	6 x 60 / 2 3/8 x 24		
Herstellmaß	597 x 597 x 10,5 mm	597 x 897 x 10,5 mm	597 x 1197 x 10,5 mm	297 x 1197 x 10,5 mm	60 x 597 x 10,5 mm		
Oberfläche	strukturiert, matt	strukturiert, matt	strukturiert, matt	strukturiert, matt	strukturiert, matt		
m ² /m - Stück	2,778/m ²	1,851/m ²	1,390/m ²	0,833/m	1,667/m		
m ² /m - kg	23,335/m ²	23,367/m ²	23,839/m ²	6,427/m	1,445/m		
Paket - Stück	3	2	2	3	24		
Paket - m ² /m	1,080 m ²	1,080 m ²	1,441 m ²	3,601 m	14,397 m		
Paket - kg	25,200	25,248	34,300	23,148	20,808		
Palette - m ²	32,397	22,680	30,259				
Palette - kg	756,000	530,208	720,300				
Produktnorm	Alb	Alb	Alb	Alb	Alb		
Trittsicherheit	R10	R10	R10	R10			
Belastung	2 - 3	2 - 3	2 - 3	2 - 3			
rost	8823-B700HK Preisgr. A139 (m ²)	8823-B755HK Preisgr. A139 (m ²)	8823-B770HK Preisgr. A162 (m ²)	8823-B729HK Preisgr. A560 (St.)	8823-B710HK Preisgr. A438 (St.)		



¹ rektifiziert

² Auftragsfertigung: Rückgabe und/oder Stormierung bestellter Ware nicht möglich.

Alle Produkte: Color Shade Variation V4

Studioaufnahme / Architekten: VSBL, Belgrad, Serbien / Serie: Streetlife / Foto: Jochen Stüber







Faszinierend in Technik und Design

Innovative Technik des Badsystem-Spezialisten Gerloff und hochwertige Feinsteinzeugfliesen von Agrob Buchtal ergeben eine wegweisende Neuheit: das Waschtisch- und Duschbodensystem SURF® by Gerloff. Durch sein puristisches Design, die Materialvielfalt und die raffinierte Ablauftechnik ist SURF® prädestiniert für die anspruchsvolle Ausstattung moderner Bäder. Ob Zement-, Holz-, Beton- oder Terrazzo-Optik – da Waschtische und Duschböden mit allen Fliesenserien und Oberflächen kombiniert werden können, bietet das System viel Gestaltungsfreiheit. Falls gewünscht, lassen sich Waschtisch und Wandfliesen optisch zu einer Einheit verschmelzen, wobei sich der Waschtisch jeder Einbausituation anpasst.

Der ästhetische Fliesen-Waschtisch

Der Waschtisch ist in den drei Größen SMALL (40 x 60 cm), MEDIUM (45 x 80 cm) und LARGE (55 x 120 cm) erhältlich. Durch entsprechende Auswahl der Oberflächen und Kombination mit passenden großformatigen Wandfliesen lassen sich Waschtisch und Wand als optische Einheit gestalten.

Edel und vielseitig

- » Konsequent puristisches Design
- » Verschiedene Oberflächen
- » Für jede Einbausituation geeignet
- » Kostengünstig
- » Anschluss an alle handelsüblichen Ablaufventile
- » Reinigungsfreundlich
- » Fugenlos
- » Schnelle, einfache Montage

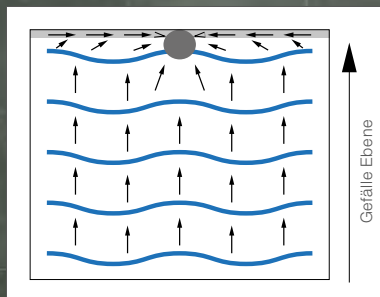



Waschtisch SURF®

small	40 x 60 cm
medium	45 x 80 cm
large	55 x 120 cm

Hinweis: Waschtisch wird inklusive Ablaufdeckel, passendem Ablauf „Clou“ und der geeigneten Halterung geliefert. Größe und Lage des Hahnlochs sind bauseits zu prüfen.



Doppelwaschtisch SURF®

large	55 x 120 cm
--------------	-------------

Hinweis: Waschtisch wird inklusive Ablaufdeckel, passendem Ablauf „Clou“ und der geeigneten Halterung geliefert. Größe und Lage des Hahnlochs sind bauseits zu prüfen.



Waschtisch mit passender Waschtischkonsole SURF®

medium	45 x 80 cm
large	55 x 120 cm

Waschtisch und Waschtischkonsole können auf Wunsch aus unterschiedlichen Serien kombiniert werden.

Ideale Fliesen für die Design-Dusche

Der Duschboden der jeweiligen Serie steht in zwei Ausführungen zur Verfügung: als SURF® Basic mit Ablaufdeckel aus Metall oder SURF® Slot mit dem eleganten, praktisch unsichtbaren Fliesen-Ablaufdeckel. Die Ablauftechnik ist komplett verlegefertig in die Fliese eingearbeitet.



Schön und funktionell

- » Minimalistisches Design
- » Verschiedene Oberflächen
- » Fugenlos
- » Reinigungsfreundlich
- » Siphon mit der Fliese wasserdicht verschraubt
- » Kostengünstig
- » Schnelle, einfache Montage

im Hartschaumblock mit Dichtlappen und Ablaufdeckel geliefert.

* auch weitere Ausführungen auf Anfrage möglich, siehe folgende Seite.



Weitere Ausführungen auf Anfrage möglich:

30 x 60 cm



Variante A



Variante B



Variante C



Variante D
Rillenfliese ohne Ablauf



Variante E



Variante F
Rillenfliese ohne Ablauf

60 x 60 cm



Variante A

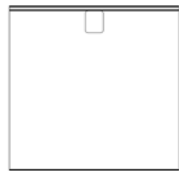

Variante B



Variante C



Variante D
Rillenfliese ohne Ablauf

60 x 120 cm



Variante A



Variante B

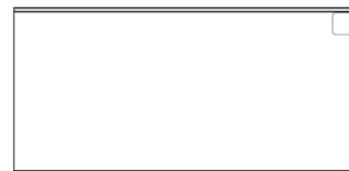

Variante C



Variante D
Rillenfliese ohne Ablauf



Variante E



Variante F
Rillenfliese ohne Ablauf



Duschbodensystem Basic mit Metallablaufdeckel



Duschbodensystem Slot mit Fliesenablaufdeckel

Waschtisch und Duschboden – die Oberflächen

Area Pro

WTS WTB WTL DTB DTL 



Nova

WTS WTB WTL DWT
KSM KSL DTB DTL 

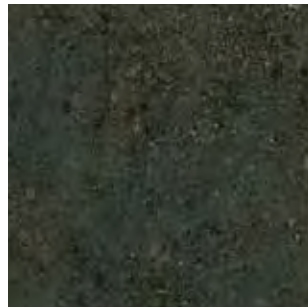

Savona

WTS WTB WTL DWT
KSM KSL DTB DTL 



Streetlife

WTS WTB WTL DWT
KSM KSL DTB DTL 

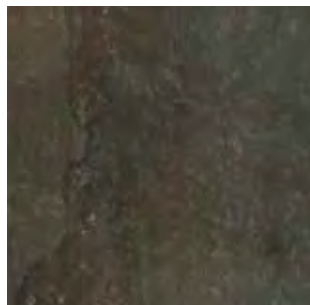

Unique

WTS WTB WTL DWT
KSM KSL DTB DTL 



Waschtisch mit
Waschtischkonsole
SURF®¹

Waschtisch
SURF®¹

Duschboden SURF®¹

45 x 80 cm

55 x 120 cm

40 x 60 cm

45 x 80 cm

55 x 120 cm

60 x 120 cm

60 x 120 cm

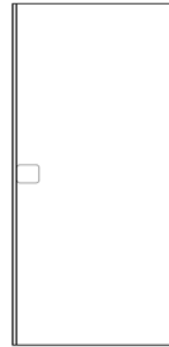
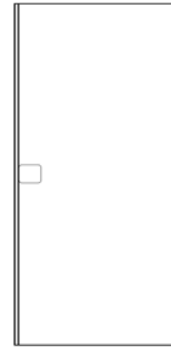
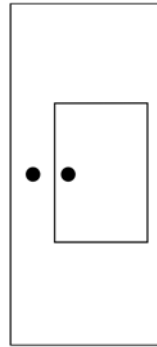
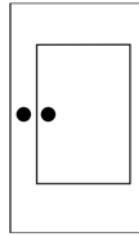
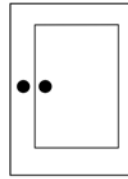
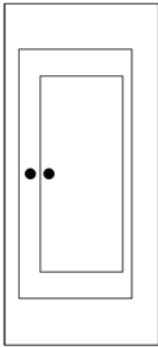
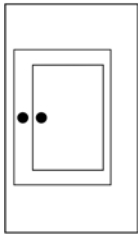

Medium	Large	Small	Medium	Large	Basic	Slot
45 x 80 / 16 x 32	55 x 120 / 22 x 48	40 x 60 / 18 x 24	45 x 80 / 16 x 32	55 x 120 / 22 x 48	60 x 120 / 24 x 48	60 x 120 / 24 x 48
450 x 800 x 65 mm	550 x 1197 x 65 mm	400 x 597 x 95 mm	450 x 800 x 95 mm	550 x 1197 x 95 mm	597 x 1197 x 120 mm	597 x 1197 x 120 mm
1	1	1	1	1	1	1
50,000	62,000	27,500	35,000	52,000	17,635	17,889
430407HKSM ²	430407HKSL ²	430407HWTS ²	430407HWTB ²	430407HWTL ²	430407HDTB ³	430407HDTL ³
Preisgr. A848 (St.)	Preisgr. A854 (St.)	Preisgr. A842 (St.)	Preisgr. A842 (St.)	Preisgr. A852 (St.)	Preisgr. A816 (St.)	Preisgr. A826 (St.)

Nennmaß - cm/in
Herstellmaß
Oberfläche
Stück
- kg
Paket - Stück
Paket
Paket - kg
Palette
Palette
Produktnorm
sandbeige

¹  Auftragsfertigung: Rückgabe und/oder Stornierung bestellter Ware nicht möglich.

Ablaufsystem SURF® by Gerloff



² Größe und Lage des Hahnlochs sind bauseits zu prüfen.

³ Weitere Varianten auf Anfrage, siehe S. 297





Elementar, modern, repräsentativ

Mit ihrer klaren, authentischen Optik und Trittsicherheiten R10/A und R11/B ist Trias geradezu prädestiniert für die moderne Bad-gestaltung für Boden und Wand. In Zinkgrau, Eisenerz, Sandgelb, Erdbraun oder Calcitweiß stehen zahlreiche Formatvarianten zur Verfügung: vom dekorativen 5 cm-Mosaik bis hin zu repräsentativen Fliesen. Die Protecta-vergütete Trias eignet sich sowohl für Nassbereiche als auch für alle Wohnbereiche.



calcitweiß



zinkgrau



eisenerz



sandgelb

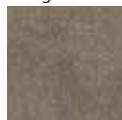

erdbraun



Boden-/Wandfliese 30 x 60 cm



Boden-/Wandfliese 60 x 60 cm



Treppenfliese 30 x 60 cm (rilliert)

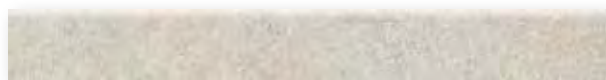

Sockel gerundet 7 x 60 cm

Mosaik 5 x 5 cm



*Mosaik, strukturiert, matt
5 x 5 cm*



*Mosaik, strukturiert, matt
5 x 5 cm*



*Mosaik, strukturiert, matt
5 x 5 cm*



*Mosaik, strukturiert, matt
5 x 5 cm*



*Mosaik, strukturiert, matt
5 x 5 cm*

Mosaik

5 x 5 cm



Bodenfliesen^{1/2}

30 x 60 cm



30 x 60 cm



60 x 60 cm



Treppenfliesen^{1/2/3}

30 x 60 cm

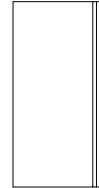

Sockel, gerundet^{1/2}

7 x 60 cm



Mosaik, Verklebung
rückseitig auf
Glasfasernetz,
Bogen: 297 x 297 mm

Nennmaß - cm/in	5 x 5 / 2 x 2	30 x 60 / 12 x 24	30 x 60 / 12 x 24	60 x 60 / 24 x 24	30 x 60 / 12 x 24	7 x 60 / 2 13/16 x 24
Herstellmaß	47 x 47 x 10,0 mm	297 x 596 x 10,0 mm	297 x 596 x 10,0 mm	596 x 596 x 10,0 mm	297 x 596 x 10,0 mm	70 x 596 x 10,0 mm
Oberfläche	strukturiert, matt	strukturiert, matt	strukturiert, matt	strukturiert, matt	strukturiert, matt	strukturiert, matt
m ² /m - Stück	11,111 Bögen/m ²	5,556/m ²	5,556/m ²	2,778/m ²	1,667/m	1,667/m
m ² /m - kg	21,800/m ²	21,724/m ²	21,724/m ²	22,780/m ²	6,968/m	1,550/m
Paket - Stück	11 Bögen	6	6	3	6	22
Paket - m ² /m	0,990/m ²	1,080/m ²	1,080/m ²	1,080/m ²	3,599/m	13,197/m
Paket - kg	21,582	23,460	23,460	24,600	25,080	20,460
Palette - m ²	29,700	43,197	43,197	43,197		
Palette - kg	647,460	938,400	938,400	984,000		
Produktnorm	Bla	Bla	Bla	Bla	Bla	Bla
Trittsicherheit	R11/B	R10/A	R11/B	R10/A	R10/A	
Belastung	1 - 2	1 - 2	1 - 2	1 - 2	1 - 2	
calcitweiß	052265 Preisgr. A277 (m ²)	052225 Preisgr. A101 (m ²)	052230 Preisgr. A113 (m ²)	052240 Preisgr. A119 (m ²)	052235 Preisgr. A474 (St.)	052245 Preisgr. A438 (St.)
zinkgrau	052266 Preisgr. A277 (m ²)	052226 Preisgr. A101 (m ²)	052231 Preisgr. A113 (m ²)	052241 Preisgr. A119 (m ²)	052236 Preisgr. A474 (St.)	052246 Preisgr. A438 (St.)
eisenerz	052267 Preisgr. A277 (m ²)	052227 Preisgr. A101 (m ²)	052232 Preisgr. A113 (m ²)	052242 Preisgr. A119 (m ²)	052237 Preisgr. A474 (St.)	052247 Preisgr. A438 (St.)
sandgelb	052268 Preisgr. A277 (m ²)	052228 Preisgr. A101 (m ²)	052233 Preisgr. A113 (m ²)	052243 Preisgr. A119 (m ²)	052238 Preisgr. A474 (St.)	052248 Preisgr. A438 (St.)
erdbraun	052269 Preisgr. A277 (m ²)	052229 Preisgr. A101 (m ²)	052234 Preisgr. A113 (m ²)	052244 Preisgr. A119 (m ²)	052239 Preisgr. A474 (St.)	052249 Preisgr. A438 (St.)



¹ rektifiziert

² Color Shade Variation: V3



³ Auftragsfertigung: Rückgabe und/oder Stornierung bestellter Ware nicht möglich.

Studioaufnahme / Architekt: architect: VSBL, Belgrad, Serbien/ Serie: Trias / Foto: Jochen Stüber





Projekt: Firmensitz pbr Planungsbüro Rohling AG / Standort: Osnabrück, Deutschland /
Architekt: pbr Planungsbüro Rohling AG, Osnabrück / Serie: Unique / Foto: Martin Lukas Kim Fotografie, Hamburg





Ausdrucksstark und vielseitig

Mit acht Formaten, acht Farben und drei Trittsicherheiten sowie einer passender Wandfliese und einer Edelstahlleiste als Dekoration eignet sich die Serie Unique für viele Anwendungsbereiche. Das Farbspektrum der Protecta-vergüteten Feinsteinzeug-Bodenfliesen, das von Kalk über Basalt bis zu Anthrazit reicht, die leicht strukturierte, dezente Oberflächen sowie die Trittsicherheiten R10/A, R10/B und R11/B ermöglichen einen vielseitigen Einsatz, auch im Nassbereich.

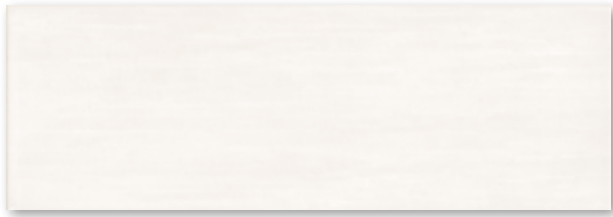

Wandfliese 20 x 60 cm
weiß



Edelstahlleiste, 5 x 60 cm



R10/A R10/B R11/B



anthrazit



basalt



hellgrau

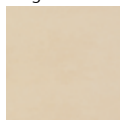

beige

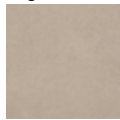

braun

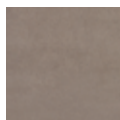

schlamm



Riegelformat 5 x 60 cm

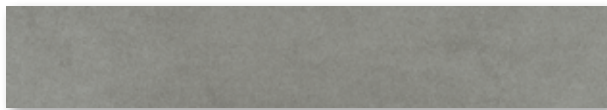

Riegelformat 10 x 60 cm

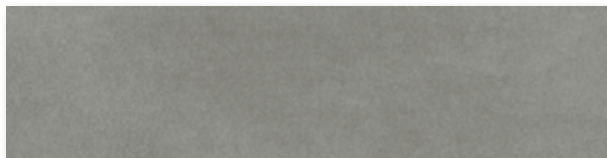

Riegelformat 15 x 60 cm



Bodenfliese 30 x 30 cm



Bodenfliese 30 x 60 cm

Mosaik 5 x 5 cm



Mosaikbogen 5 x 5 cm,
trittsicher R10/B



R10/A

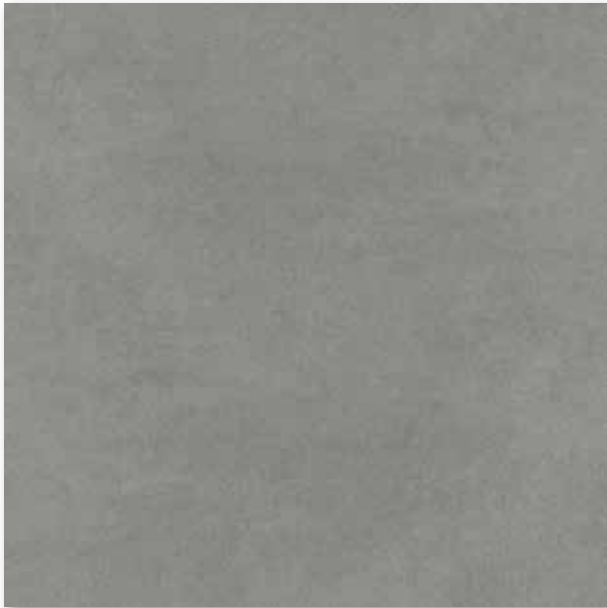

Bodenfliese 60 x 60 cm



Treppenfliese 30 x 60 cm (rilliert)

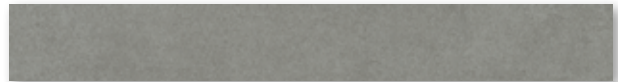

Sockel, gerundet 7 x 60 cm

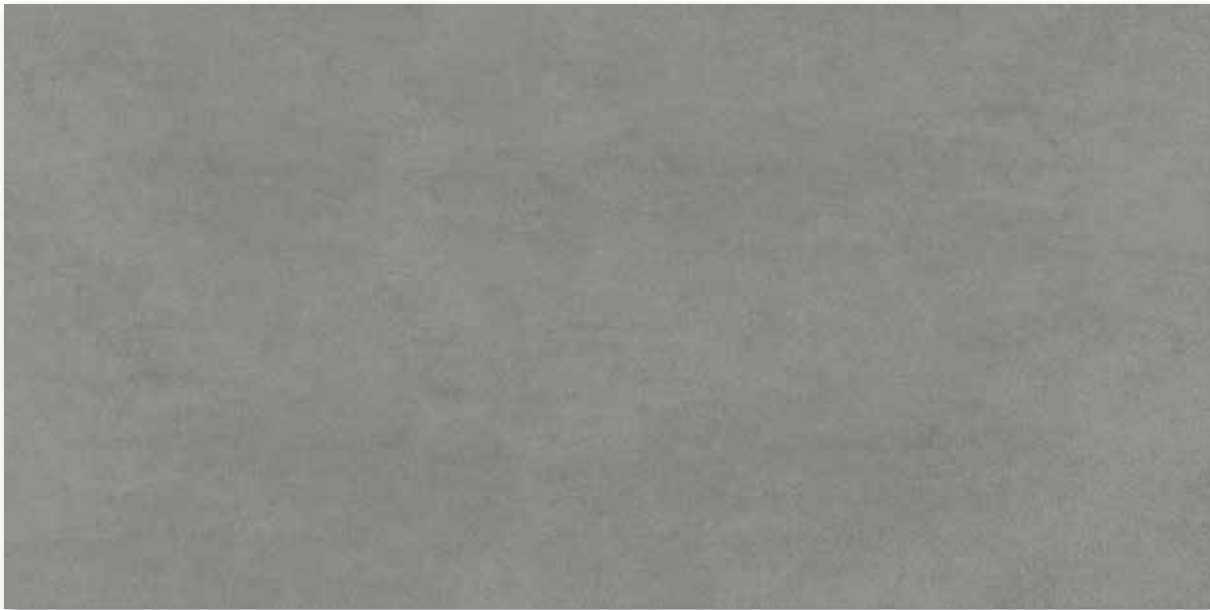

Bodenfliese 60 x 120 cm

Wandfliese Edelstahlleiste

20 x 60 cm

5 x 60 cm²



Nennmaß - cm/in	20 x 60 / 8 x 24	5 x 60 / 2 x 24				
Herstellmaß	197 x 597 x 9 mm	47 x 597 x 10 mm				
Oberfläche	eben, matt	eben, matt				
m ² /m - Stück	8,333/m ²	1,667/m				
m ² /m - kg	15,516/m ²	0,917/m				
Paket - Stück	8	3				
Paket - m ² /m	0,960 m ²	1,800 m				
Paket - kg	14,896	1,650				
Palette - m ²	61,442					
Palette - kg	953,344					
Produktnorm	BIII					
weiß	381799H Preisgr. A81 (m ²)					
Edelstahl		436698 Preisgr. A519 (St.)				

² ohne Hytect-Veredelung

Mosaik Bodenfliesen

5 x 5 cm¹

5 x 60 cm^{1/2}

10 x 60 cm^{1/2}

15 x 60 cm^{1/2}

30 x 30 cm¹

30 x 60 cm¹

30 x 60 cm¹



Mosaik, Verklebung
rückseitig auf
Glasfasernetz
Bogen: 297x297 mm

Nennmaß - cm/in	5 x 5 / 2 x 2	5 x 60 / 2 x 24	10 x 60 / 4 x 24	15 x 60 / 6 x 24	30 x 30 / 12 x 12	30 x 60 / 12 x 24	30 x 60 / 12 x 24
Herstellmaß	47 x 47 x 10,5 mm	47 x 597 x 10,5 mm	97 x 597 x 10,5 mm	147 x 597 x 10,5 mm	297 x 297 x 10,5 mm	297 x 597 x 10,5 mm	297 x 597 x 10,5 mm
Oberfläche	eben, matt	eben, matt	eben, matt	eben, matt	eben, matt	eben, matt	eben, matt
m ² - Stück	11,111	33,333	16,667	11,111	11,111	5,556	5,556
m ² - kg	22,222	22,233	23,667	23,222	23,144	23,224	23,224
Paket - Stück	11 Bögen	33	15	11	11	6	6
Paket - m ²	0,990	0,990	0,900	0,990	0,990	1,080	1,080
Paket - kg	22,000	22,011	21,300	22,990	22,913	25,080	25,080
Palette - m ²	29,700	39,600	35,999	39,600	41,580	43,197	43,197
Palette - kg	660,000	880,440	852,000	919,600	962,346	1.003,200	1.003,200
Produktnorm	Alb	Alb	Alb	Alb	Alb	Alb	Alb
Trittsicherheit	R10/B	R10/A	R10/A	R10/A	R10/A	R10/A	R11/B
Belastung	1 - 2	2 - 3	2 - 3	2 - 3	2 - 3	2 - 3	2 - 3
anthrazit	433793 Preisgr. A245 (m ²)	433787 Preisgr. A184 (m ²)	433770 Preisgr. A184 (m ²)	433778 Preisgr. A177 (m ²)	433841 Preisgr. A60 (m ²)	433671 Preisgr. A94 (m ²)	434414 Preisgr. A101 (m ²)
basalt	433794 Preisgr. A245 (m ²)	433786 Preisgr. A184 (m ²)	433771 Preisgr. A184 (m ²)	433779 Preisgr. A177 (m ²)	433842 Preisgr. A60 (m ²)	433672 Preisgr. A94 (m ²)	434415 Preisgr. A101 (m ²)
hellgrau	433795 Preisgr. A245 (m ²)	433789 Preisgr. A184 (m ²)	433772 Preisgr. A184 (m ²)	433780 Preisgr. A177 (m ²)	433843 Preisgr. A60 (m ²)	433673 Preisgr. A94 (m ²)	434416 Preisgr. A101 (m ²)
beige	433796 Preisgr. A245 (m ²)	433891 Preisgr. A184 (m ²)	433773 Preisgr. A184 (m ²)	433781 Preisgr. A177 (m ²)	433844 Preisgr. A60 (m ²)	433674 Preisgr. A94 (m ²)	434417 Preisgr. A101 (m ²)
schlamm	433797 Preisgr. A245 (m ²)	433788 Preisgr. A184 (m ²)	433774 Preisgr. A184 (m ²)	433782 Preisgr. A177 (m ²)	433846 Preisgr. A60 (m ²)	433675 Preisgr. A94 (m ²)	434418 Preisgr. A101 (m ²)
braun	433799 Preisgr. A245 (m ²)	433893 Preisgr. A184 (m ²)	433776 Preisgr. A184 (m ²)	433784 Preisgr. A177 (m ²)	433848 Preisgr. A60 (m ²)	433677 Preisgr. A94 (m ²)	434445 Preisgr. A101 (m ²)



¹ rektifiziert



² Auftragsfertigung: Rückgabe und/oder Stornierung bestellter Ware nicht möglich.



Alle Produkte: Color Shade Variation V2

Bodenfliesen

Treppenfliesen

Sockel, gerundet

60 x 60 cm¹

60 x 120 cm¹

30 x 60 cm^{1/2}

7 x 60 cm¹



	60 x 60 / 24 x 24	60 x 120 / 24 x 48	30 x 60 / 12 x 24	7 x 60 / 2 13/16 x 24	Nennmaß - cm/in
	597 x 597 x 10,5 mm	597 x 1197 x 8 mm	297 x 597 x 10,5 mm	70 x 597 x 10,5 mm	Herstellmaß
	eben, matt	eben, matt	eben, matt	eben, matt	Oberfläche
	2,778/m ²	1,388/m ²	1,667/m	1,667/m	m ² /m - Stück
	23,769/m ²	17,489/m ²	6,968/m	1,584/m	m ² /m - kg
	3	2	6	15	Paket - Stück
	1,080 m ²	1,441 m ²	3,599 m	8,998 m	Paket - m ² /m
	25,668	25,200	25,080	14,250	Paket - kg
	32,397	36,023			Palette - m ²
	770,040	630,000			Palette - kg
	Alb	Alb	Alb	Alb	Produktnorm
	R10/A	R10/A	R10/A		Trittsicherheit
	2 - 3	2 - 3	2 - 3		Belastung
	433701	434432	433678	433685	anthrazit
	Preisgr. A119 (m ²)	Preisgr. A169 (m ²)	Preisgr. A465 (St.)	Preisgr. A441 (St.)	
	433702	434433	433679	433686	basalt
	Preisgr. A119 (m ²)	Preisgr. A169 (m ²)	Preisgr. A465 (St.)	Preisgr. A441 (St.)	
	433703	434434	433680	433687	hellgrau
	Preisgr. A119 (m ²)	Preisgr. A169 (m ²)	Preisgr. A465 (St.)	Preisgr. A441 (St.)	
	433704	434435	433681	433688	beige
	Preisgr. A119 (m ²)	Preisgr. A169 (m ²)	Preisgr. A465 (St.)	Preisgr. A441 (St.)	
	433705	434436	433682	433689	schlamm
	Preisgr. A119 (m ²)	Preisgr. A169 (m ²)	Preisgr. A465 (St.)	Preisgr. A441 (St.)	
	433707	434438	433684	433691	braun
	Preisgr. A119 (m ²)	Preisgr. A169 (m ²)	Preisgr. A465 (St.)	Preisgr. A441 (St.)	

rektifiziert

Auftragsfertigung: Rückgabe und/oder Stornierung bestellter Ware nicht möglich.

Alle Produkte: Color Shade Variation V2







Natürlich und lebhaft

Die Feinsteinzeugserie Valley wurde inspiriert vom Panorama der weit entfernten Landschaft einer Talebene. Davon zeugen ihr erdiges Relief und ihre feinen, körnigen Strukturverläufe. Jede Farbe weckt unterschiedliche Assoziationen: an Blau- oder Tonschiefer, Flusskiesel, Sand und Erde. Witterungseinflüsse, Erdbewegungen, Wasserflüsse und metallische Materialeinlagerungen zeichnen zusätzlich eine lebendige Oberfläche typischer „Berg-Tal-Wirkung“. Mit Digitaldrucktechnik gefertigt, verfügt Valley über bis zu 26 verschiedene Fliesenbilder. Die Serie wird abgerundet durch eine überstarke, frostsichere Terrassenplatte in allen vier Farben, die auch zur Verlegung in Sand oder Kies geeignet ist.



R10/A R10/B R11/B



schiefer



kieselgrau



erdbraun



sandbeige



Riegelformat 5 x 60 cm



Riegelformat 10 x 60 cm



Riegelformat 15 x 60 cm



Riegelformat 20 x 60 cm

Mosaik 5 x 5 cm



Mosaikbogen 5 x 5 cm,
trittsicher R11/B



Boden-/Wandfliese 15 x 15 cm,
trittsicher R10/B



Boden-/Wandfliese 30 x 30 cm



Boden-/Wandfliese 30 x 60 cm



Bodenfliese 60 x 60 cm, Terrassenplatte 60 x 60 cm



Bodenfliese 75 x 75 cm

Keramische Rinnenabdeckung*,
25 x 50 cm



Keramische Rinnenabdeckung*,
Ecklösung 30 x 30 cm



ohne Abbildung:
Rinnenstein mit Ablauf,
Gehrungspaar, Endstück

*Details siehe Kapitel Pool + Spa; Keramische Rinnenabdeckung 2.0,
Seite 439, (auftragsbezogene Fertigung).



Bodenfliese 60 x 120 cm



Sockel, gerundet 7 x 60 cm



Sockel, gerundet 7 x 75 cm



Treppenfliese 30 x 60 cm (rilliert)

Mosaik

Boden-/Wandfliesen³

5 x 5 cm¹



15 x 15 cm



5 x 60 cm^{1/2}



10 x 60 cm^{1/2}



15 x 60 cm^{1/2}



20 x 60 cm^{1/2}



Mosaik, Verkl. rückseitig auf Glasfasernetz
Bogen: 297 x 297 mm

Riegelformat

Riegelformat

Riegelformat

Riegelformat

Nennmaß - cm/in	5 x 5 / 2 x 2	15 x 15 / 6 x 6	5 x 60 / 2 x 24	10 x 60 / 4 x 24	15 x 60 / 6 x 24	20 x 60 / 8 x 24
Herstellmaß	47 x 47 x 10 mm	147 x 147 x 8 mm	46 x 596 x 10 mm	96 x 596 x 10 mm	146 x 596 x 10 mm	196 x 596 x 10 mm
Oberfläche	strukturiert, matt	strukturiert, matt	strukturiert, matt	strukturiert, matt	strukturiert, matt	strukturiert, matt
m ² - Stück	11,111	44,444	33,333	16,667	11,111	8,333
m ² - kg	21,800	17,555	22,233	22,667	22,000	23,749
Paket - Stück	11 Bögen	35	33	15	11	8
Paket - m ²	0,990	0,788	0,990	0,900	0,990	0,960
Paket - kg	21,582	13,825	22,011	20,400	21,780	22,800
Palette - m ²	29,700	63,001	39,600	35,999	39,600	40,322
Palette - kg	647,460	1.106,000	880,440	816,000	871,200	957,600
Produktnorm	Bla	Bla	Bla	Bla	Bla	Bla
Trittsicherheit	R11/B	R10/B	R10/A	R10/A	R10/A	R10/A
Belastung	2 - 3	2	2 - 3	2 - 3	2 - 3	2 - 3
schiefer	052089 Preisgr. A271 (m ²)	052477 Preisgr. A125 (m ²)	<i>052044</i> <i>Preisgr. A184</i> (m ²)	<i>052048</i> <i>Preisgr. A184</i> (m ²)	<i>052052</i> <i>Preisgr. A177</i> (m ²)	<i>052461</i> <i>Preisgr. A177</i> (m ²)
kieselgrau	052090 Preisgr. A271 (m ²)	052478 Preisgr. A125 (m ²)	<i>052045</i> <i>Preisgr. A184</i> (m ²)	<i>052049</i> <i>Preisgr. A184</i> (m ²)	<i>052053</i> <i>Preisgr. A177</i> (m ²)	<i>052462</i> <i>Preisgr. A177</i> (m ²)
erdbraun	052091 Preisgr. A271 (m ²)	052479 Preisgr. A125 (m ²)	<i>052046</i> <i>Preisgr. A184</i> (m ²)	<i>052050</i> <i>Preisgr. A184</i> (m ²)	<i>052054</i> <i>Preisgr. A177</i> (m ²)	<i>052463</i> <i>Preisgr. A177</i> (m ²)
sandbeige	052092 Preisgr. A271 (m ²)	052480 Preisgr. A125 (m ²)	<i>052047</i> <i>Preisgr. A184</i> (m ²)	<i>052051</i> <i>Preisgr. A184</i> (m ²)	<i>052055</i> <i>Preisgr. A177</i> (m ²)	<i>052464</i> <i>Preisgr. A177</i> (m ²)



¹ rektifiziert

² Auftragsfertigung: Rückgabe und/oder Stornierung bestellter Ware nicht möglich.

³ Color Shade Variation: V2

Boden-/Wandfliesen³

30 x 30 cm¹



30 x 60 cm¹



30 x 60 cm¹



60 x 60 cm¹



60 x 120 cm^{1/2/4}

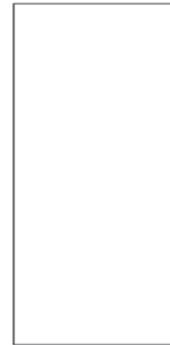

75 x 75 cm^{1/2}



Nennmaß - cm/in	30 x 30 / 12 x 12	30 x 60 / 12 x 24	30 x 60 / 12 x 24	60 x 60 / 24 x 24	60 x 120 / 24 x 48	75 x 75 / 30 x 30
Herstellmaß	297 x 297 x 10 mm	297 x 596 x 10 mm	297 x 596 x 10 mm	596 x 596 x 10 mm	596 x 1195 x 10,5 mm	748 x 748 x 10 mm
Oberfläche	strukturiert, matt	strukturiert, matt	strukturiert, matt	strukturiert, matt	strukturiert, matt	strukturiert, matt
m ² - Stück	11,111	5,556	5,556	2,778	1,388	1,778
m ² - kg	23,144	22,780	22,780	22,780	23,180	22,758
Paket - Stück	11	6	6	3	2	2
Paket - m ²	0,990	1,080	1,080	1,080	1,441	1,125
Paket - kg	22,913	24,600	24,600	24,600	33,400	25,600
Palette - m ²	41,580	43,197	43,197	43,197	21,614	47,244
Palette - kg	962,346	984,000	984,000	984,000	501,000	1.075,200
Produktnorm	Bla	Bla	Bla	Bla	Bla	Bla
Trittsicherheit	R11/B	R10/A	R11/B	R10/A	R10/A	R10/A
Belastung	2 - 3	2 - 3	2 - 3	2 - 3	2 - 3	2 - 3
schiefer	052032 Preisgr. A81 (m ²)	052016 Preisgr. A110 (m ²)	052036 Preisgr. A119 (m ²)	052020 Preisgr. A125 (m ²)	052024 Preisgr. A184 (m ²)	052028 Preisgr. A125 (m ²)
kieselgrau	052033 Preisgr. A81 (m ²)	052017 Preisgr. A110 (m ²)	052037 Preisgr. A119 (m ²)	052021 Preisgr. A125 (m ²)	052025 Preisgr. A184 (m ²)	052029 Preisgr. A125 (m ²)
erdbraun	052034 Preisgr. A119 (m ²)	052018 Preisgr. A139 (m ²)	052038 Preisgr. A150 (m ²)	052022 Preisgr. A150 (m ²)	052026 Preisgr. A197 (m ²)	052030 Preisgr. A155 (m ²)
sandbeige	052035 Preisgr. A81 (m ²)	052019 Preisgr. A110 (m ²)	052039 Preisgr. A119 (m ²)	052023 Preisgr. A125 (m ²)	052027 Preisgr. A184 (m ²)	052031 Preisgr. A125 (m ²)



¹ rektifiziert

³ Color Shade Variation: V2
Großformate werden in Kisten gegen Aufpreis vermarktet

² Hohes Gewicht! Karton bitte nur zu Zweit transportieren.
⁴ Achtung: Sonderpalette. Keine Rücknahme, kein Umtausch.

Terrassen-
platten⁴

60 x 60 cm^{1/2}



Treppen-
fliesen⁴

30 x 60 cm^{1/3}



Sockel,
gerundet⁴

7 x 60 cm¹



7 x 75 cm¹



protected

		60 x 60 / 24 x 24	30 x 60 / 12 x 24	7 x 60 / 2 13/16 x 24	7 x 75 / 2 7/8 x 30	Nennmaß - cm/in
		596 x 596 x 20 mm	297 x 596 x 10 mm	70 x 596 x 10 mm	70 x 748 x 10,0 mm	Herstellmaß
		strukturiert, matt	strukturiert, matt	strukturiert, matt	strukturiert, matt	Oberfläche
		2,778/m ²	1,667/m	1,667/m	1,333/m	m ² /m - Stück
		46,948/m ²	6,968/m	1,550/m	1,599/m	m ² /m - kg
		2	6	22	6	Paket - Stück
		0,720 m ²	3,599 m	13,197 m	4,501 m	Paket - m ² /m
		33,800	25,080	20,460	7,200	Paket - kg
		21,598				Palette - m ²
		1.014,000				Palette - kg
		Bla	Bla	Bla	Bla	Produktnorm
		R11/B	R10/A			Trittsicherheit
		4	2 - 3			Belastung
		052085	<i>052068</i>	052072	052081	
		Preisgr. A210 (m ²)	Preisgr. A475 (St.)	Preisgr. A438 (St.)	Preisgr. A445 (St.)	schiefer
		052086	<i>052069</i>	052073	052082	
		Preisgr. A210 (m ²)	Preisgr. A475 (St.)	Preisgr. A438 (St.)	Preisgr. A445 (St.)	kieselgrau
		052087	<i>052070</i>	052074	052083	
		Preisgr. A230 (m ²)	Preisgr. A475 (St.)	Preisgr. A438 (St.)	Preisgr. A445 (St.)	erdbraun
		052088	<i>052071</i>	052075	052084	
		Preisgr. A210 (m ²)	Preisgr. A475 (St.)	Preisgr. A438 (St.)	Preisgr. A445 (St.)	sandbeige



² Hohes Gewicht! Karton bitte nur zu Zweit transportieren.



⁴ Color Shade Variation: V2





Ausgezeichnet und zeitlos

Dezent geaderte Steinoptik in drei flexiblen Farben und eine samtig wirkende Oberfläche mit Glittereffekt machen den speziellen Reiz der Feinsteinzeugfliese Xeno aus. Zur Verlegung mit schmaler Fuge sind die Formate rektifiziert. Die Bodenfliesen werden durch Treppenfliesen und Sockelleisten ergänzt. Dank Protecta-Vergütung lässt sich die unglasierte Fliesenoberfläche mühelos reinigen.



anthrazit

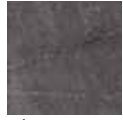

schwarz



steingrau



Riegelformat 5 x 60 cm



Riegelformat 10 x 60 cm



Riegelformat 15 x 60 cm



Riegelformat 20 x 60 cm



Boden-/Wandfliesen 30 x 60 cm



Treppenfliese 30 x 60 cm (rilliert)



Sockel geschnitten 7 x 60 cm

Boden-/Wandfliesen³

5 x 60 cm^{1/2}



10 x 60 cm^{1/2}



15 x 60 cm^{1/2}



20 x 60 cm^{1/2}



30 x 60 cm¹



Treppen-
fliesen³

30 x 60 cm^{1/2}



Sockel,
geschnitten³

7 x 60 cm¹



protected

Riegelformat	Riegelformat	Riegelformat	Riegelformat	Riegelformat	Riegelformat	Riegelformat	Riegelformat	Nennmaß - cm/in
5 x 60 / 2 x 24	10 x 60 / 4 x 24	15 x 60 / 6 x 24	20 x 60 / 8 x 24	30 x 60 / 12 x 24	30 x 60 / 12 x 24	30 x 60 / 12 x 24	7 x 60 / 2 13/16 x 24	Herstellmaß
47 x 597 x 10,5 mm	97 x 597 x 10,5 mm	147 x 597 x 10,5 mm	197 x 597 x 10,5 mm	297 x 597 x 10,5 mm	297 x 597 x 10,5 mm	297 x 597 x 10,5 mm	70 x 597 x 10,5 mm	Oberfläche
strukturiert, matt	strukturiert, matt	strukturiert, matt	strukturiert, matt	strukturiert, matt	strukturiert, matt	strukturiert, matt	strukturiert, matt	m ² /m - Stück
33,333/m ²	16,667/m ²	11,111/m ²	8,333/m ²	5,556/m ²	1,667/m	1,667/m	1,667/m	m ² /m - kg
22,233/m ²	23,667/m ²	23,222/m ²	23,749/m ²	23,224/m ²	6,968/m	6,968/m	1,717/m	Paket - Stück
33	15	11	8	6	6	6	20	Paket - m ² /m
0,990 m ²	0,900 m ²	0,990 m ²	0,960 m ²	1,080 m ²	3,599 m	3,599 m	11,998 m	Paket - kg
22,011	21,300	22,990	22,800	25,080	25,080	25,080	20,600	Palette - m ²
39,600	35,999	39,600	40,322	43,197				Palette - kg
880,440	852,000	919,591	957,600	1.003,200				Palette - m ²
Bla	Bla	Bla	Bla	Bla	Bla	Bla	Bla	Produktnorm
R10/A	R10/A	R10/A	R10/A	R10/A	R10/A	R10/A		Trittsicherheit
2 - 3	2 - 3	2 - 3	2 - 3	2 - 3	2 - 3	2 - 3		Belastung
433228	433240	433233	433251	432974	432663	432663	432805	
Preisgr. A192 (m ²)	Preisgr. A192 (m ²)	Preisgr. A184 (m ²)	Preisgr. A184 (m ²)	Preisgr. A125 (m ²)	Preisgr. A475 (St.)	Preisgr. A475 (St.)	Preisgr. A434 (St.)	anthrazit
433229	433241	433234	433252	432975	432664	432664	432806	
Preisgr. A192 (m ²)	Preisgr. A192 (m ²)	Preisgr. A184 (m ²)	Preisgr. A184 (m ²)	Preisgr. A125 (m ²)	Preisgr. A475 (St.)	Preisgr. A475 (St.)	Preisgr. A434 (St.)	schwarz
433231	433244	433236	433254	432977	432666	432666	432808	
Preisgr. A192 (m ²)	Preisgr. A192 (m ²)	Preisgr. A184 (m ²)	Preisgr. A184 (m ²)	Preisgr. A125 (m ²)	Preisgr. A475 (St.)	Preisgr. A475 (St.)	Preisgr. A434 (St.)	steingrau

¹ rektifiziert

² Auftragsfertigung: Rückgabe und/oder Stornierung bestellter Ware nicht möglich

³ Color Shade Variation: V2

Bodenfliesen 30 x 60 cm überstark,
15 mm siehe Serie New Market S. 225







Pool + Spa

Projekt: Paracelsus Bad & Kurhaus / Standort: Salzburg, Österreich / Architekt: Berger + Parkkinen /
Serie: Beckenkopfsystem Wiesbaden, Savona / Foto: Christian Richters



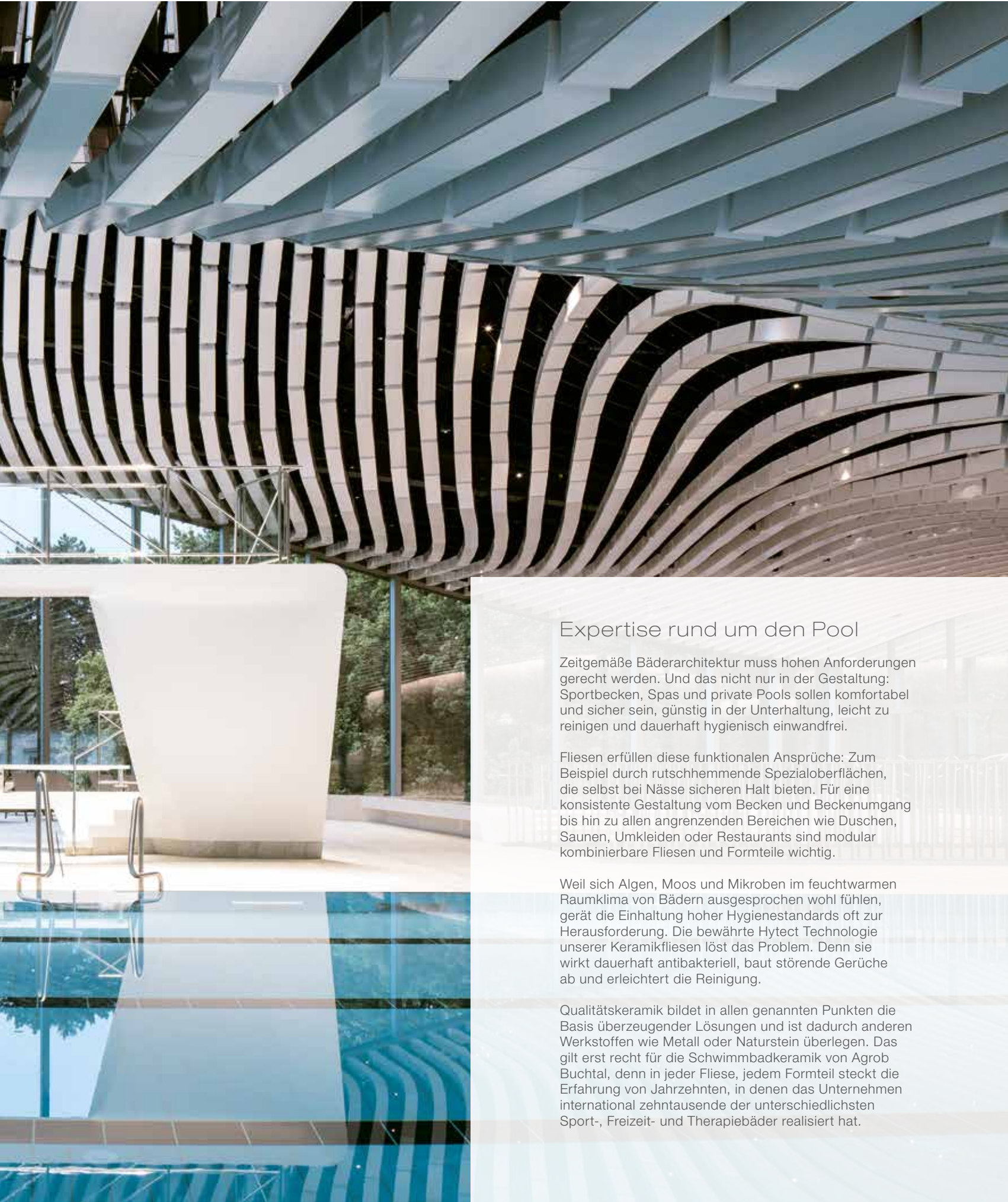

Expertise rund um den Pool

Zeitgemäße Bäderarchitektur muss hohen Anforderungen gerecht werden. Und das nicht nur in der Gestaltung: Sportbecken, Spas und private Pools sollen komfortabel und sicher sein, günstig in der Unterhaltung, leicht zu reinigen und dauerhaft hygienisch einwandfrei.

Fliesen erfüllen diese funktionalen Ansprüche: Zum Beispiel durch rutschhemmende Spezialoberflächen, die selbst bei Nässe sicheren Halt bieten. Für eine konsistente Gestaltung vom Becken und Beckenumgang bis hin zu allen angrenzenden Bereichen wie Duschen, Saunen, Umkleiden oder Restaurants sind modular kombinierbare Fliesen und Formteile wichtig.

Weil sich Algen, Moos und Mikroben im feuchtwarmen Raumklima von Bädern ausgesprochen wohl fühlen, gerät die Einhaltung hoher Hygienestandards oft zur Herausforderung. Die bewährte Hytect Technologie unserer Keramikfliesen löst das Problem. Denn sie wirkt dauerhaft antibakteriell, baut störende Gerüche ab und erleichtert die Reinigung.

Qualitätskeramik bildet in allen genannten Punkten die Basis überzeugender Lösungen und ist dadurch anderen Werkstoffen wie Metall oder Naturstein überlegen. Das gilt erst recht für die Schwimmbadkeramik von Agrob Buchtal, denn in jeder Fliese, jedem Formteil steckt die Erfahrung von Jahrzehnten, in denen das Unternehmen international zehntausende der unterschiedlichsten Sport-, Freizeit- und Therapiebäder realisiert hat.

Becken + Beckenumgang

Form vollenden. Fassung bewahren.



Sport- und Wettkampfbecken

Projekt: Duna Aréna / Standort: Budapest, Ungarn /
Architekt: NAPUR Architect Kft / Foto: Péter Molnár / Serie: Plural



Freibäder

Projekt: Aquapark Cikat / Standort: Mali Losinji, Kroatien /
Architekt: Urbing d.o.o. / Foto: Michael Meschede / Serie: Chroma



Freizeit/Erlebnisbäder

Projekt: Havel-Therme / Standort: Werder (Havel); Deutschland /
Architekt: Geising & Böker GmbH Architekten BDA, Hamburg /
Foto: Jochen Stüber / Serie: Savona, Plural



Schul-/Lehrbäder

Projekt: City of London Freeman's School / Standort: London,
Großbritannien / Architekt: Hawkins Brown Architects LLP /
Foto: Jack Hobhouse photography / Serie: Chroma,
Beckenkopfsystem Finland



Thermal-/Heilbäder

Projekt: Chiemgau Thermen / Standort: Bad Endorf, Deutschland /
Architekt: Architekturwerkstatt Zopf, Salzburg, Österreich /
Foto: Peters Fotodesign, Amerang / Serie: Quarzit

Hotelbäder

Projekt: Hotel aja Garmisch-Partenkirchen / Standort: Garmisch-Partenkirchen,
Deutschland / Architekt: SMAP SEEGER MÜLLER Berlin und Büro Korb, Hamburg /
Foto: JFotodesign Peters, Amerang / Serie: Quarzit, Savona



Privatbäder

Projekt: Villa an der Costa Blanca, Spanien / Standort: Denia, Spanien /
Foto: Marcella Grassi, Barcelona / Serie: Quarzit

Starke Argumente sprechen für Schwimmbadkeramik von Agrob Buchtal

- Jahrzehntelange Erfahrung mit Schwimmbadkeramik für höchste Ansprüche
- Anwendungstechnische Beratung und Entlastung von Routineaufgaben durch den Agrob Buchtal Architektenservice
- Hytect-Technologie für leichte Reinigung, antibakterielle Wirkung und Abbau von Luftschadstoffen
- Unfallschutz durch abgestufte Trittsicherheit bei optimaler Reinigungsfreundlichkeit mit dem GRIP-Gütesiegel
- Größtmögliche Gestaltungsfreiheit dank enormer Farb- und Formatvielfalt und individuellen Sonderfertigungsmöglichkeiten
- Spezielle Beckenkopfsysteme für unterschiedlichste Nutzungsarten
- Perfekt abgestimmtes Zubehör für Lösungen aus einer Hand
- Kosteneffiziente Lösung für alle Bäderarten und -größen
- Maximale Widerstandsfähigkeit von Keramik auch bei salz- und schwefelhaltigen Thermalwässern

Duschen + Umkleiden

Freiheit in Farbe, Dekor und Format



Die Konzeption eines Schwimmbads endet nicht am Beckenrand. Zum ästhetischen Gesamtbild gehört die stimmige Gestaltung von Duschen, Umkleiden, Foyers und auch Restaurants. Gerade hier ist es wichtig, unterschiedliche Formate innerhalb eines Farbsystems frei kombinieren zu können.

Dies ist mit dem modularen Farbsystem ChromaPlural möglich. Das Angebot reicht von Mosaiken, schmalen Riemchen in verschiedenen Längen bis hin zu Großformaten. Räume und Flächen lassen sich somit skalieren, elegant proportionieren und rhythmisieren. So gelingt eine raumübergreifende Gestaltung von Wand- und Bodenflächen.



Wellness + Spa

Natürliche Wellnesslandschaft
für höchste Ansprüche



Spas und Wellness-Oasen sind Orte der Ruhe und sollen Körper und Seele entspannen. Mit weitläufigen Ausblicken in Landschaften, Analogien zu ursprünglichen Elementen und natürlichen Materialien lässt sich die Natur auf den Raum übertragen. Ebenso mit organischen, ursprünglichen Formen. Sie erinnern an weiche Formationen oder fließende Bewegungen der Natur. Wie zum Beispiel die des Wassers. Kleinste Mosaiksteinchen, ob rund oder eckig folgen diesen Formen und bedecken wie eine Haut selbst kleinste Rundungen.

Gäste erwarten in Wellness- und Spa-Anlagen außerdem maximale Hygiene und Sauberkeit. Hytect-Keramikfliesen helfen Betreibern, dieses Ziel umweltschonend zu erreichen. Die Oberfläche von Hytect-Keramik setzt im Zusammenspiel mit Licht auf natürlichem Weg aktiven Sauerstoff frei. Dieser hemmt das Wachstum von Schimmel und Bakterien direkt auf der Oberfläche.







Im Element: Chroma

Besonders unter Wasser sind die Anforderungen an den Architektur-Rohstoff Keramik groß. Chroma bündelt alle Erfahrungen im Schwimmbadbau zu einer speziell auf den Unterwasserbereich abgestimmten Produktserie für Architekten und Planer. Standardmäßig wird das vor allem im Beckenbau weit verbreitete Fugemaß von 6 mm verwendet.

Stabilität im Becken: 6 mm Fuge



Physikalische Beanspruchungen führen zu hohen Belastungen im Beckenbereich, die ein spezielles Fugenmaß sinnvoll machen. Die Auslegung auf eine 6 mm Fuge sorgt dabei für maximale Sicherheit.

Sicherheit ohne Kompromisse

Unfallschutz hat in jedem Schwimmbad höchste Priorität – vor allem in besonders rutschgefährdeten Bereichen, wie in Wasser führende Treppen oder Durchschreibecken. Darum bietet Chroma auch die Trittsicherheitsklassen der Kategorie „C“. Sind höchste Anforderungen an Gestaltung und Sicherheit kompromisslos und einheitlich umsetzbar.

- Chroma
- Chroma non-slip
- Chroma unglasiert

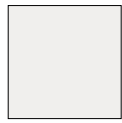

neutral 10 (aktivweiß)



azur dunkel



azur mittel



azur hell



azur aktiv

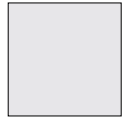

neutral 9 (weißgrau)



blau dunkel



blau mittel



blau hell



blau aktiv



neutral 8 (lichtgrau)



türkis dunkel



türkis mittel



türkis hell



türkis aktiv



neutral 7 (kieselgrau)



grün dunkel



grün mittel



grün hell



grün aktiv



neutral 6 (perlgrau)



gelb dunkel



gelb mittel



gelb hell



gelb aktiv



neutral 5 (basaltgrau)



ocker dunkel



ocker mittel



ocker hell



ocker aktiv



neutral 4 (graphitschwarz)



lachs dunkel



lachs mittel



lachs hell



lachs aktiv



neutral 3 (asphaltschwarz)



oxidrot dunkel



oxidrot mittel



oxidrot hell



oxidrot aktiv



neutral 2 (anthrazit)



steingrau dunkel



steingrau mittel



steingrau hell



steingrau aktiv



neutral 1 (tiefschwarz)



sandgrau dunkel



sandgrau mittel



sandgrau hell



sandgrau aktiv

Kontrast-Farben
(glänzend)



weiß



schwarz



orange



zitronengelb



kontrastrot



intensivblau



apfelgrün



violett



*Boden-/Wandfliese
6,2 x 25 cm*

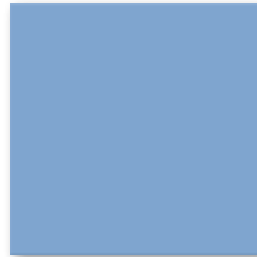

*Boden-/Wandfliese
25 x 25 cm*



*Boden-/Wandfliese
12,5 x 12,5 cm*

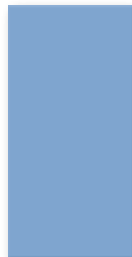

*Boden-/Wandfliese
12,5 x 25 cm*

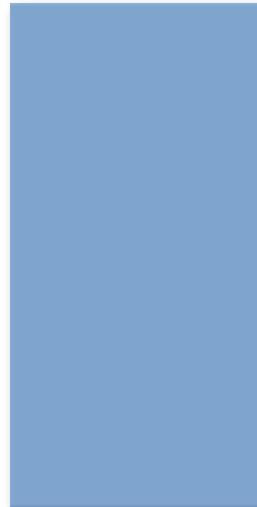

*Boden-/Wandfliese
25 x 50 cm*

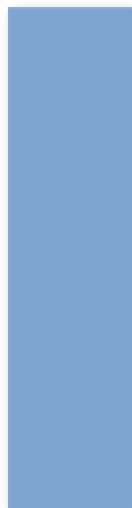

*Boden-/Wandfliese
12,5 x 50 cm*

Boden-/Wandfliesen

6,2 x 25 cm²



12,5 x 12,5 cm²



12,5 x 25 cm²



12,5 x 50 cm¹

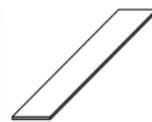

25 x 25 cm²



25 x 50 cm¹

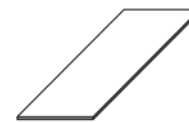

Lieferung als Doppel-
fliesen; müssen örtlich
gebrochen werden

Lieferung als Doppel-
fliesen; müssen örtlich
gebrochen werden

Formatnummer	18210H	12020H	18120H	41550HK	12050H	42550HK
Nennmaß - cm/in	6,2 x 25 / 2 1/2 x 10	12,5 x 12,5 / 5 x 5	12,5 x 25 / 5 x 10	12,5 x 50 / 5 x 20	25 x 25 / 10 x 10	25 x 50 / 10 x 20
Herstellmaß	56 x 244 x 6 mm	119 x 119 x 6 mm	119 x 244 x 6 mm	119 x 494 x 8 mm	244 x 244 x 6 mm	244 x 494 x 8 mm
Oberfläche	eben, seidenmatt ⁵	eben, seidenmatt ⁵	eben, seidenmatt ⁵	eben, seidenmatt ⁵	eben, seidenmatt ⁵	eben, seidenmatt ⁵
m ² - Stück	64,000	64,000	32,000	16,000	16,000	8,000
m ² - kg	10,880	12,160	12,160	17,040	12,800	17,040
Paket - Stück	88	88	44	8	18	9
Paket - m ²	1,375	1,375	1,375	0,500	1,125	1,125
Paket - kg	14,960	16,720	16,720	8,520	14,400	19,170
Palette - m ²	132,000	115,500	115,500	55,000	91,125	40,500
Palette - kg	1.436,160	1.404,480	1.404,480	937,200	1.166,400	690,120
Produktnorm	Alb	Alb	Alb	Alb	Alb	Alb
neutral 10 (aktivweiß glzd.)	4 700i-18210H Preisgr. A150 (m ²)	700i-12020H Preisgr. A150 (m ²)	700i-18120H Preisgr. A94 (m ²)	700i-41550HK Preisgr. A150 (m ²)	700i-12050H Preisgr. A150 (m ²)	700i-42550HK Preisgr. A150 (m ²)
neutral 10 (aktivweiß matt)	4 701i-18210H Preisgr. A150 (m ²)	701i-12020H Preisgr. A150 (m ²)	701i-18120H Preisgr. A94 (m ²)	701i-41550HK Preisgr. A150 (m ²)	701i-12050H Preisgr. A150 (m ²)	701i-42550HK Preisgr. A150 (m ²)
neutral 1 (tiefschwarz)	1 5716i-18210H⁴ Preisgr. A177 (m ²)	5716i-12020H⁴ Preisgr. A177 (m ²)	5716i-18120H⁴ Preisgr. A125 (m ²)	5716-41550HK⁴ Preisgr. A177 (m ²)	5716i-12050H⁴ Preisgr. A177 (m ²)	5716i-42550HK⁴ Preisgr. A177 (m ²)
azur aktiv	2 552001-18210H Preisgr. A177 (m ²)	552001-12020H Preisgr. A177 (m ²)	552001-18120H Preisgr. A125 (m ²)	552001-41550HK Preisgr. A177 (m ²)	552001-12050H Preisgr. A177 (m ²)	552001-42550HK Preisgr. A177 (m ²)
azur hell	4 552002-18210H Preisgr. A177 (m ²)	552002-12020H Preisgr. A177 (m ²)	552002-18120H Preisgr. A125 (m ²)	552002-41550HK Preisgr. A177 (m ²)	552002-12050H Preisgr. A177 (m ²)	552002-42550HK Preisgr. A177 (m ²)
azur mittel	3 552003-18210H Preisgr. A177 (m ²)	552003-12020H Preisgr. A177 (m ²)	552003-18120H Preisgr. A125 (m ²)	552003-41550HK³ Preisgr. A177 (m ²)	552003-12050H Preisgr. A177 (m ²)	552003-42550HK Preisgr. A177 (m ²)
azur dunkel	2 552004-18210H Preisgr. A177 (m ²)	552004-12020H Preisgr. A177 (m ²)	552004-18120H Preisgr. A125 (m ²)	552004-41550HK³ Preisgr. A209 (m ²)	552004-12050H³ Preisgr. A209 (m ²)	552004-42550HK³ Preisgr. A209 (m ²)
blau aktiv	2 552005-18210H³ Preisgr. A209 (m ²)	552005-12020H Preisgr. A177 (m ²)	552005-18120H Preisgr. A125 (m ²)	552005-41550HK³ Preisgr. A209 (m ²)	552005-12050H Preisgr. A177 (m ²)	552005-42550HK³ Preisgr. A209 (m ²)
blau hell	4 552006-18210H³ Preisgr. A209 (m ²)	552006-12020H Preisgr. A177 (m ²)	552006-18120H Preisgr. A125 (m ²)	552006-41550HK³ Preisgr. A209 (m ²)	552006-12050H Preisgr. A177 (m ²)	552006-42550HK Preisgr. A177 (m ²)
blau mittel	3 552007-18210H Preisgr. A177 (m ²)	552007-12020H Preisgr. A177 (m ²)	552007-18120H Preisgr. A125 (m ²)	552007-41550HK³ Preisgr. A209 (m ²)	552007-12050H Preisgr. A177 (m ²)	552007-42550HK Preisgr. A177 (m ²)
blau dunkel	2 552008-18210H Preisgr. A177 (m ²)	552008-12020H³ Preisgr. A209 (m ²)	552008-18120H Preisgr. A125 (m ²)	552008-41550HK³ Preisgr. A209 (m ²)	552008-12050H³ Preisgr. A209 (m ²)	552008-42550HK³ Preisgr. A209 (m ²)
türkis aktiv	2 552009-18210H Preisgr. A177 (m ²)	552009-12020H³ Preisgr. A209 (m ²)	552009-18120H Preisgr. A125 (m ²)	552009-41550HK³ Preisgr. A209 (m ²)	552009-12050H³ Preisgr. A209 (m ²)	552009-42550HK³ Preisgr. A209 (m ²)
türkis hell	4 552010-18210H Preisgr. A177 (m ²)	552010-12020H Preisgr. A125 (m ²)	552010-18120H Preisgr. A125 (m ²)	552010-41550HK³ Preisgr. A209 (m ²)	552010-12050H³ Preisgr. A209 (m ²)	552010-42550HK³ Preisgr. A209 (m ²)
türkis mittel	3 552011-18210H Preisgr. A177 (m ²)	552011-12020H Preisgr. A177 (m ²)	552011-18120H Preisgr. A125 (m ²)	552011-41550HK³ Preisgr. A209 (m ²)	552011-12050H Preisgr. A177 (m ²)	552011-42550HK³ Preisgr. A209 (m ²)
türkis dunkel	2 552012-18210H⁴ Preisgr. A177 (m ²)	552012-12020H⁴ Preisgr. A177 (m ²)	552012-18120H⁴ Preisgr. A125 (m ²)	552012-41550HK^{3/4} Preisgr. A209 (m ²)	552012-12050H^{3/4} Preisgr. A209 (m ²)	552012-42550HK^{3/4} Preisgr. A209 (m ²)
grün aktiv	2 552013-18210H Preisgr. A177 (m ²)	552013-12020H Preisgr. A177 (m ²)	552013-18120H Preisgr. A125 (m ²)	552013-41550HK³ Preisgr. A209 (m ²)	552013-12050H³ Preisgr. A209 (m ²)	552013-42550HK³ Preisgr. A209 (m ²)
grün hell	4 552014-18210H Preisgr. A177 (m ²)	552014-12020H Preisgr. A177 (m ²)	552014-18120H Preisgr. A125 (m ²)	552014-41550HK³ Preisgr. A209 (m ²)	552014-12050H Preisgr. A177 (m ²)	552014-42550HK³ Preisgr. A209 (m ²)
grün mittel	3 552015-18210H Preisgr. A177 (m ²)	552015-12020H Preisgr. A177 (m ²)	552015-18120H Preisgr. A125 (m ²)	552015-41550HK³ Preisgr. A209 (m ²)	552015-12050H Preisgr. A177 (m ²)	552015-42550HK Preisgr. A177 (m ²)
grün dunkel	2 552016-18210H Preisgr. A177 (m ²)	552016-12020H Preisgr. A177 (m ²)	552016-18120H Preisgr. A125 (m ²)	552016-41550HK³ Preisgr. A209 (m ²)	552016-12050H Preisgr. A177 (m ²)	552016-42550HK³ Preisgr. A209 (m ²)
gelb aktiv	2 552017-18210H^{3/4} Preisgr. A209 (m ²)	552017-12020H^{3/4} Preisgr. A209 (m ²)	552017-18120H⁴ Preisgr. A125 (m ²)	552017-41550HK^{3/4} Preisgr. A209 (m ²)	552017-12050H^{3/4} Preisgr. A209 (m ²)	552017-42550HK^{3/4} Preisgr. A209 (m ²)
gelb hell	4 552018-18210H³ Preisgr. A209 (m ²)	552018-12020H Preisgr. A177 (m ²)	552018-18120H Preisgr. A125 (m ²)	552018-41550HK³ Preisgr. A209 (m ²)	552018-12050H Preisgr. A177 (m ²)	552018-42550HK Preisgr. A177 (m ²)
gelb mittel	3 552019-18210H Preisgr. A177 (m ²)	552019-12020H Preisgr. A177 (m ²)	552019-18120H Preisgr. A125 (m ²)	552019-41550HK³ Preisgr. A209 (m ²)	552019-12050H Preisgr. A177 (m ²)	552019-42550HK³ Preisgr. A209 (m ²)
gelb dunkel	2 552020-18210H⁴ Preisgr. A177 (m ²)	552020-12020H^{3/4} Preisgr. A209 (m ²)	552020-18120H⁴ Preisgr. A125 (m ²)	552020-41550HK^{3/4} Preisgr. A209 (m ²)	552020-12050H^{3/4} Preisgr. A209 (m ²)	552020-42550HK^{3/4} Preisgr. A209 (m ²)



1  rektifiziert

2  Überglasierte Kanten / Ecken siehe S. 337

3  Auftragsfertigung: Rückgabe und/oder Stornierung bestellter Ware nicht möglich.

4  produktionsbedingte Farbabweichungen zum Standard sind möglich.

5 Ausnahme: aktivweiß glänzend: eben, glänzend

Boden-/Wandfliesen

6,2 x 25 cm²



Lieferung als Doppel-
fliesen; müssen örtlich
gebrochen werden

12,5 x 12,5 cm²



Lieferung als Doppel-
fliesen; müssen örtlich
gebrochen werden

12,5 x 25 cm²



12,5 x 50 cm¹



25 x 25 cm²



25 x 50 cm¹



18210H	12020H	18120H	41550HK	12050H	42550HK	Beanspruchungsgruppe
6,2 x 25 / 2 1/2 x 10 56 x 244 x 6 mm eben, seidenmatt 64,000 10,880 88 1,375 14,960 132,000 1.436,160 Alb	12,5 x 12,5 / 5 x 5 119 x 119 x 6 mm eben, seidenmatt 64,000 12,160 88 1,375 16,720 115,500 1.404,480 Alb	12,5 x 25 / 5 x 10 119 x 244 x 6 mm eben, seidenmatt 32,000 12,160 44 1,375 16,720 115,500 1.404,480 Alb	12,5 x 50 / 5 x 20 119 x 494 x 8 mm eben, seidenmatt 16,000 17,040 8 0,500 8,520 55,000 937,200 Alb	25 x 25 / 10 x 10 244 x 244 x 6 mm eben, seidenmatt 16,000 12,800 18 1,125 14,400 91,125 1.166,400 Alb	25 x 50 / 10 x 20 244 x 494 x 8 mm eben, seidenmatt 8,000 17,040 9 1,125 19,170 40,500 690,120 Alb	
552021-18210H ^{3/4} Preisgr. A209 (m ²)	552021-12020H ^{3/4} Preisgr. A209 (m ²)	552021-18120H ^{3/4} Preisgr. A150 (m ²)	552021-41550HK ^{3/4} Preisgr. A209 (m ²)	552021-12050H ^{3/4} Preisgr. A209 (m ²)	552021-42550HK ^{3/4} Preisgr. A209 (m ²)	2
552022-18210H Preisgr. A209 (m ²)	552022-12020H ³ Preisgr. A209 (m ²)	552022-18120H ³ Preisgr. A150 (m ²)	552022-41550HK ³ Preisgr. A209 (m ²)	552022-12050H ³ Preisgr. A209 (m ²)	552022-42550HK ³ Preisgr. A209 (m ²)	4
552023-18210H ³ Preisgr. A209 (m ²)	552023-12020H ³ Preisgr. A209 (m ²)	552023-18120H Preisgr. A125 (m ²)	552023-41550HK ³ Preisgr. A209 (m ²)	552023-12050H ³ Preisgr. A209 (m ²)	552023-42550HK ³ Preisgr. A209 (m ²)	3
552024-18210H ³ Preisgr. A209 (m ²)	552024-12020H ³ Preisgr. A209 (m ²)	552024-18120H Preisgr. A125 (m ²)	552024-41550HK ³ Preisgr. A209 (m ²)	552024-12050H ³ Preisgr. A209 (m ²)	552024-42550HK ³ Preisgr. A209 (m ²)	2
552025-18210H ⁴ Preisgr. A177 (m ²)	552025-12020H ^{3/4} Preisgr. A209 (m ²)	552025-18120H ^{3/4} Preisgr. A150 (m ²)	552025-41550HK ^{3/4} Preisgr. A209 (m ²)	552025-12050H ^{3/4} Preisgr. A209 (m ²)	552025-42550HK ^{3/4} Preisgr. A209 (m ²)	2
552026-18210H Preisgr. A177 (m ²)	552026-12020H ³ Preisgr. A209 (m ²)	552026-18120H Preisgr. A125 (m ²)	552026-41550HK ³ Preisgr. A209 (m ²)	552026-12050H ³ Preisgr. A209 (m ²)	552026-42550HK ³ Preisgr. A209 (m ²)	4
552027-18210H Preisgr. A177 (m ²)	552027-12020H ³ Preisgr. A209 (m ²)	552027-18120H ³ Preisgr. A150 (m ²)	552027-41550HK ³ Preisgr. A209 (m ²)	552027-12050H Preisgr. A177 (m ²)	552027-42550HK ³ Preisgr. A209 (m ²)	3
552028-18210H ³ Preisgr. A209 (m ²)	552028-12020H ³ Preisgr. A209 (m ²)	552028-18120H ³ Preisgr. A150 (m ²)	552028-41550HK ³ Preisgr. A209 (m ²)	552028-12050H ³ Preisgr. A209 (m ²)	552028-42550HK ³ Preisgr. A209 (m ²)	2
552029-18210H Preisgr. A177 (m ²)	552029-12020H ³ Preisgr. A209 (m ²)	552029-18120H Preisgr. A125 (m ²)	552029-41550HK ³ Preisgr. A209 (m ²)	552029-12050H Preisgr. A177 (m ²)	552029-42550HK ³ Preisgr. A209 (m ²)	2
552030-18210H ³ Preisgr. A209 (m ²)	552030-12020H ³ Preisgr. A209 (m ²)	552030-18120H ³ Preisgr. A150 (m ²)	552030-41550HK ³ Preisgr. A209 (m ²)	552030-12050H Preisgr. A177 (m ²)	552030-42550HK ³ Preisgr. A209 (m ²)	4
552031-18210H Preisgr. A177 (m ²)	552031-12020H ³ Preisgr. A209 (m ²)	552031-18120H ³ Preisgr. A150 (m ²)	552031-41550HK ³ Preisgr. A209 (m ²)	552031-12050H Preisgr. A177 (m ²)	552031-42550HK ³ Preisgr. A209 (m ²)	3
552032-18210H Preisgr. A177 (m ²)	552032-12020H ³ Preisgr. A209 (m ²)	552032-18120H Preisgr. A125 (m ²)	552032-41550HK ³ Preisgr. A209 (m ²)	552032-12050H ³ Preisgr. A209 (m ²)	552032-42550HK ³ Preisgr. A209 (m ²)	2
552033-18210H Preisgr. A177 (m ²)	552033-12020H ³ Preisgr. A209 (m ²)	552033-18120H Preisgr. A125 (m ²)	552033-41550HK ³ Preisgr. A209 (m ²)	552033-12050H ³ Preisgr. A209 (m ²)	552033-42550HK ³ Preisgr. A209 (m ²)	2
552034-18210H ³ Preisgr. A209 (m ²)	552034-12020H ³ Preisgr. A209 (m ²)	552034-18120H ³ Preisgr. A150 (m ²)	552034-41550HK ³ Preisgr. A209 (m ²)	552034-12050H ³ Preisgr. A209 (m ²)	552034-42550HK ³ Preisgr. A209 (m ²)	4
552035-18210H Preisgr. A177 (m ²)	552035-12020H Preisgr. A177 (m ²)	552035-18120H Preisgr. A125 (m ²)	552035-41550HK ³ Preisgr. A209 (m ²)	552035-12050H ³ Preisgr. A209 (m ²)	552035-42550HK ³ Preisgr. A209 (m ²)	3
552036-18210H ³ Preisgr. A209 (m ²)	552036-12020H ³ Preisgr. A209 (m ²)	552036-18120H Preisgr. A125 (m ²)	552036-41550HK ³ Preisgr. A209 (m ²)	552036-12050H ³ Preisgr. A209 (m ²)	552036-42550HK ³ Preisgr. A209 (m ²)	2
552037-18210H ³ Preisgr. A209 (m ²)	552037-12020H ³ Preisgr. A209 (m ²)	552037-18120H Preisgr. A125 (m ²)	552037-41550HK ³ Preisgr. A209 (m ²)	552037-12050H ³ Preisgr. A209 (m ²)	552037-42550HK ³ Preisgr. A209 (m ²)	2
552038-18210H Preisgr. A177 (m ²)	552038-12020H Preisgr. A177 (m ²)	552038-18120H Preisgr. A125 (m ²)	552038-41550HK ³ Preisgr. A209 (m ²)	552038-12050H Preisgr. A177 (m ²)	552038-42550HK ³ Preisgr. A209 (m ²)	4
552039-18210H ³ Preisgr. A209 (m ²)	552039-12020H ³ Preisgr. A209 (m ²)	552039-18120H Preisgr. A125 (m ²)	552039-41550HK ³ Preisgr. A209 (m ²)	552039-12050H ³ Preisgr. A209 (m ²)	552039-42550HK ³ Preisgr. A209 (m ²)	3
552040-18210H ³ Preisgr. A209 (m ²)	552040-12020H ³ Preisgr. A209 (m ²)	552040-18120H Preisgr. A125 (m ²)	552040-41550HK ³ Preisgr. A209 (m ²)	552040-12050H ³ Preisgr. A209 (m ²)	552040-42550HK ³ Preisgr. A177 (m ²)	2
552119-18210H ³ Preisgr. A209 (m ²)	552119-12020H ³ Preisgr. A209 (m ²)	552119-18120H Preisgr. A125 (m ²)	552119-41550HK ³ Preisgr. A209 (m ²)	552119-12050H ³ Preisgr. A209 (m ²)	552119-42550HK ³ Preisgr. A209 (m ²)	4
552118-18210H Preisgr. A177 (m ²)	552118-12020H ³ Preisgr. A209 (m ²)	552118-18120H Preisgr. A125 (m ²)	552118-41550HK ³ Preisgr. A209 (m ²)	552118-12050H ³ Preisgr. A209 (m ²)	552118-42550HK ³ Preisgr. A209 (m ²)	4
552117-18210H Preisgr. A177 (m ²)	552117-12020H ³ Preisgr. A209 (m ²)	552117-18120H Preisgr. A125 (m ²)	552117-41550HK ³ Preisgr. A209 (m ²)	552117-12050H Preisgr. A177 (m ²)	552117-42550HK ³ Preisgr. A209 (m ²)	4



² Überglasierte Kanten / Ecken siehe S. 337

³ Auftragsfertigung: Rückgabe und/oder Stornierung bestellter Ware nicht möglich.

⁴ produktionsbedingte Farbabweichungen zum Standard sind möglich.



Boden-/Wandfliesen

6,2 x 25 cm²



12,5 x 12,5 cm²



12,5 x 25 cm²



12,5 x 50 cm¹



25 x 25 cm²



25 x 50 cm¹



Lieferung als Doppel-
fliesen; müssen örtlich
gebrochen werden

Lieferung als Doppel-
fliesen; müssen örtlich
gebrochen werden

Formatnummer	18210H	12020H	18120H	41550HK	12050H	42550HK
Nennmaß - cm/in	6,2 x 25 / 2 1/2 x 10	12,5 x 12,5 / 5 x 5	12,5 x 25 / 5 x 10	12,5 x 50 / 5 x 20	25 x 25 / 10 x 10	25 x 50 / 10 x 20
Herstellmaß	56 x 244 x 6 mm	119 x 119 x 6 mm	119 x 244 x 6 mm	119 x 494 x 8 mm	244 x 244 x 6 mm	244 x 494 x 8 mm
Oberfläche	eben, seidenmatt ⁶	eben, seidenmatt ⁶	eben, seidenmatt ⁶	eben, seidenmatt ⁶	eben, seidenmatt ⁶	eben, seidenmatt ⁶
m ² - Stück	64,000	64,000	32,000	16,000	16,000	8,000
m ² - kg	10,880	12,160	12,160	17,040	12,800	17,040
Paket - Stück	88	88	44	8	18	9
Paket - m ²	1,375	1,375	1,375	0,500	1,125	1,125
Paket - kg	14,960	16,720	16,720	8,520	14,400	19,170
Palette - m ²	132,000	115,500	115,500	55,000	91,125	40,500
Palette - kg	1.436,160	1.404,480	1.404,480	937,200	1.166,400	690,120
Produktnorm	Alb	Alb	Alb	Alb	Alb	Alb
Beanspruchungsgruppe	3	3	3	3	3	3
neutral 6 (perlgrau)	552116-18210H ³ Preisgr. A209 (m ²)	552116-12020H ³ Preisgr. A209 (m ²)	552116-18120H Preisgr. A125 (m ²)	552116-41550HK ³ Preisgr. A209 (m ²)	552116-12050H ³ Preisgr. A209 (m ²)	552116-42550HK ³ Preisgr. A209 (m ²)
neutral 5 (basaltgrau)	552115-18210H ³ Preisgr. A209 (m ²)	552115-12020H ³ Preisgr. A209 (m ²)	552115-18120H ³ Preisgr. A150 (m ²)	552115-41550HK ³ Preisgr. A209 (m ²)	552115-12050H ³ Preisgr. A209 (m ²)	552115-42550HK ³ Preisgr. A209 (m ²)
neutral 4 (graphitschwarz)	552114-18210H ^{3/4} Preisgr. A209 (m ²)	552114-12020H ^{3/4} Preisgr. A209 (m ²)	552114-18120H ^{3/4} Preisgr. A150 (m ²)	552114-41550HK ^{3/4} Preisgr. A209 (m ²)	552114-12050H ^{3/4} Preisgr. A209 (m ²)	552114-42550HK⁴ Preisgr. A177 (m ²)
neutral 3 (asphaltschwarz)	552113-18210H ³ Preisgr. A209 (m ²)	552113-12020H ³ Preisgr. A209 (m ²)	552113-18120H Preisgr. A125 (m ²)	552113-41550HK ³ Preisgr. A209 (m ²)	552113-12050H ³ Preisgr. A209 (m ²)	552113-42550HK ³ Preisgr. A209 (m ²)
neutral 2 (anthrazit)	552112-18210H Preisgr. A177 (m ²)	552112-12020H ³ Preisgr. A209 (m ²)	552112-18120H Preisgr. A125 (m ²)	552112-41550HK ³ Preisgr. A209 (m ²)	552112-12050H Preisgr. A177 (m ²)	552112-42550HK Preisgr. A177 (m ²)
schwarz glänzend	717i-18210H ³ Preisgr. A209 (m ²)	717i-12020H ³ Preisgr. A209 (m ²)	717i-18120H ³ Preisgr. A150 (m ²)	717i-41550HK ³ Preisgr. A209 (m ²)	717i-12050H ³ Preisgr. A209 (m ²)	717i-42550HK ³ Preisgr. A209 (m ²)
orange glänzend	151i-18210H ³ Preisgr. A209 (m ²)	151i-12020H ³ Preisgr. A209 (m ²)	151i-18120H ³ Preisgr. A150 (m ²)	151i-41550HK ³ Preisgr. A209 (m ²)	151i-12050H ³ Preisgr. A209 (m ²)	151i-42550HK ³ Preisgr. A209 (m ²)
zitronengelb glänzend	150i-18210H ³ Preisgr. A209 (m ²)	150i-12020H ³ Preisgr. A209 (m ²)	150i-18120H ³ Preisgr. A150 (m ²)	150i-41550HK ³ Preisgr. A209 (m ²)	150i-12050H ³ Preisgr. A209 (m ²)	150i-42550HK ³ Preisgr. A209 (m ²)
kontrastrot glänzend	154i-18210H ³ Preisgr. A209 (m ²)	154i-12020H ³ Preisgr. A209 (m ²)	154i-18120H ³ Preisgr. A150 (m ²)	154i-41550HK ³ Preisgr. A209 (m ²)	154i-12050H ³ Preisgr. A209 (m ²)	154i-42550HK ³ Preisgr. A209 (m ²)
intensivblau glänzend	144-18210 ^{3/5} Preisgr. A209 (m ²)	144-12020 ^{3/5} Preisgr. A209 (m ²)	144-18120 ^{3/5} Preisgr. A150 (m ²)	144-41550K ^{3/5} Preisgr. A209 (m ²)	144-12050 ^{3/5} Preisgr. A209 (m ²)	144-42550K ^{3/5} Preisgr. A209 (m ²)
apfelgrün glänzend	152i-18210H ³ Preisgr. A209 (m ²)	152i-12020H ³ Preisgr. A209 (m ²)	152i-18120H ³ Preisgr. A150 (m ²)	152i-41550HK ³ Preisgr. A209 (m ²)	152i-12050H ³ Preisgr. A209 (m ²)	152i-42550HK ³ Preisgr. A209 (m ²)
violett glänzend	153i-18210H ³ Preisgr. A209 (m ²)	153i-12020H ³ Preisgr. A209 (m ²)	153i-18120H ³ Preisgr. A150 (m ²)	153i-41550HK ³ Preisgr. A209 (m ²)	153i-12050H ³ Preisgr. A209 (m ²)	153i-42550HK ³ Preisgr. A209 (m ²)



² Überglasierte Kanten / Ecken siehe S. 337

³ Auftragsfertigung: Rückgabe und/oder Stornierung bestellter Ware nicht möglich.



⁴ produktionsbedingte Farbabweichungen zum Standard sind möglich

⁵ ohne Hytect-Veredelung

⁶ Ausnahme: Kontrastfarben schwarz, orange, zitronengelb, kontrastrot, intensivblau, apfelgrün, violett: eben, glänzend

Überglasierte Kanten/Ecken^{1/2} Boden-/Wandfliesen

6,2 x 25 cm



6,2 x 25 cm



12,5 x 12,5 cm



12,5 x 25 cm



12,5 x 25 cm



25 x 25 cm



überglasierte
Ecke links

überglasierte
Ecke rechts

überglasierte
Ecke links

überglasierte
Ecke links

überglasierte
Ecke rechts

überglasierte
Ecke links

18213H	18214H	12023H	18123H	18124H	12053H	Beanspruchungsgruppe	
6,2 x 25 / 2 1/2 x 10	6,2 x 25 / 2 1/2 x 10	12,5 x 12,5 / 5 x 5	12,5 x 25 / 5 x 10	12,5 x 25 / 5 x 10	25 x 25 / 10 x 10		Formatnummer
56 x 244 x 6 mm	56 x 244 x 6 mm	119 x 119 x 6 mm	119 x 244 x 6 mm	119 x 244 x 6 mm	244 x 244 x 6 mm		Nennmaß - cm/in
eben, seidenmatt ⁴	eben, seidenmatt ⁴	eben, seidenmatt ⁴	eben, seidenmatt ⁴	eben, seidenmatt ⁴	eben, seidenmatt ⁴		Herstellmaß
64,000	64,000	64,000	32,000	32,000	16,000		Oberfläche
10,880	10,880	12,160	12,160	12,160	12,800		m ² - Stück
88	88	88	44	44	18		m ² - kg
1,375	1,375	1,375	1,375	1,375	1,125		Paket - Stück
14,960	14,960	16,720	16,720	16,720	14,400		Paket - m ²
132,000	132,000	115,500	115,500	115,500	91,125		Paket - kg
1.436,160	1.436,160	1.404,480	1.404,480	1.404,480	1.166,400		Palette - m ²
Alb	Alb	Alb	Alb	Alb	Alb		Palette - kg
700i-18213H	700i-18214H	700i-12023H	700i-18123H	700i-18124H	700i-12053H		Produktnorm
Preisgr. A150 (m ²)	Preisgr. A150 (m ²)	Preisgr. A150 (m ²)	Preisgr. A94 (m ²)	Preisgr. A94 (m ²)	Preisgr. A150 (m ²)	4 neutral 10 (aktivweiß glzd.)	
701i-18213H	701i-18214H	701i-12023H	701i-18123H	701i-18124H	701i-12053H	4 neutral 10 (aktivweiß matt)	
Preisgr. A150 (m ²)	Preisgr. A150 (m ²)	Preisgr. A150 (m ²)	Preisgr. A94 (m ²)	Preisgr. A94 (m ²)	Preisgr. A150 (m ²)		
5716i-18213H ³	5716i-18214H ³	5716i-12023H ³	5716i-18123H ³	5716i-18124H ³	5716i-12053H ³	1 neutral 1 (tiefschwarz)	
Preisgr. A177 (m ²)	Preisgr. A177 (m ²)	Preisgr. A177 (m ²)	Preisgr. A125 (m ²)	Preisgr. A125 (m ²)	Preisgr. A177 (m ²)		
552001-18213H	552001-18214H	552001-12023H	552001-18123H	552001-18124H	552001-12053H	2 azur aktiv	
Preisgr. A177 (m ²)	Preisgr. A177 (m ²)	Preisgr. A177 (m ²)	Preisgr. A125 (m ²)	Preisgr. A125 (m ²)	Preisgr. A177 (m ²)		
552002-18213H	552002-18214H	552002-12023H	552002-18123H	552002-18124H	552002-12053H	4 azur hell	
Preisgr. A177 (m ²)	Preisgr. A177 (m ²)	Preisgr. A177 (m ²)	Preisgr. A125 (m ²)	Preisgr. A125 (m ²)	Preisgr. A177 (m ²)		



¹ weitere Farben auf Anfrage lieferbar

² Auftragsfertigung: Rückgabe und/oder Stornierung bestellter Ware nicht möglich.



³ Produktionsbedingte Farbabweichung zum Standard möglich.

⁴ Ausnahme: aktivweiß glänzend: eben, glänzend

Überglasierte Kanten
auf Anfrage lieferbar:



Grundformat-Nr. statt
Endziffer 0 Endziffer ...

... 3 = Ecke links

... 4 = Ecke rechts

überglasierte Kanten

Beispiel: Grundformat-Nr. 18120 = 119 x 244 x 6 mm,
Format-Nr. 18123 = überglasierte Ecke links

Trittsicherheit „B“

-/B



weiß / neutral 10
(aktivweiß)



neutral 9
(weißgrau)



neutral 8
(lichtgrau)



553117 neutral 7
(kieselgrau)



neutral 6
(perlgrau)



neutral 5
(basaltgrau)



neutral 4
(graphitschwarz)



neutral 3
(asphaltschwarz)



neutral 2
(anthrazit)



schwarz / neutral 1
(tiefschwarz)

-/B



azur dunkel



blau dunkel



grün dunkel



steingrau dunkel



sandgrau dunkel



azur mittel



blau mittel



türkis mittel



grün mittel



gelb mittel



ocker mittel



lachs mittel



oxidrot mittel



steingrau mittel



sandgrau mittel



azur hell



blau hell



türkis hell



grün hell



gelb hell

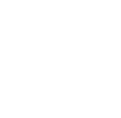

lachs hell



steingrau hell



sandgrau hell

-/B



azur aktiv



steingrau aktiv



sandgrau aktiv

-/B



kontrastrot



Bodenfliese
12,5 x 12,5 cm



Bodenfliese
12,5 x 25 cm



Bodenfliese
25 x 25 cm

Auf Anfrage sind
weitere Farben
der Serie Chroma
als non-slip Glasur
in 6 mm Fugenbreite
lieferbar.

Trittsicherheit „B“

Bodenfliesen

12,5 x 12,5 cm²



12,5 x 25 cm²



25 x 25 cm²



Lieferung als Doppel-
fliesen; müssen örtlich
gebrochen werden



32020H	38110H	32050H	Formatnummer
12,5 x 12,5 / 5 x 5	12,5 x 25 / 5 x 10	25 x 25 / 10 x 10	Nennmaß - cm/in
119 x 119 x 8 mm	119 x 244 x 8 mm	244 x 244 x 8 mm	Herstellmaß
eben, seidenmatt	eben, seidenmatt	eben, seidenmatt	Oberfläche
64,000	32,000	16,000	m ² - Stück
15,360	15,680	16,960	m ² - kg
66	33	14	Paket - Stück
1,031	1,031	0,875	Paket - m ²
15,840	16,170	14,840	Paket - kg
86,625	86,625	70,875	Palette - m ²
1.330,560	1.358,280	1.202,040	Palette - kg
Alb	Alb	Alb	Produktnorm
-/B	-/B	-/B	Trittsicherheit
2	2	2	Belastung
91i-32020H	91i-38110H	91i-32050H	neutral 10
Preisgr. A216 (m ²)	Preisgr. A192 (m ²)	Preisgr. A210 (m ²)	(aktivweiß)
340i-32020H	340i-38110H	340i-32050H	neutral 1
Preisgr. A216 (m ²)	Preisgr. A192 (m ²)	Preisgr. A210 (m ²)	(tiefschwarz)
553001-32020H	553001-38110H	553001-32050H	azur aktiv
Preisgr. A216 (m ²)	Preisgr. A192 (m ²)	Preisgr. A210 (m ²)	
553002-32020H	553002-38110H	553002-32050H	azur hell
Preisgr. A216 (m ²)	Preisgr. A192 (m ²)	Preisgr. A210 (m ²)	
553003-32020H	553003-38110H	553003-32050H	azur mittel
Preisgr. A216 (m ²)	Preisgr. A192 (m ²)	Preisgr. A210 (m ²)	
553004-32020H	553004-38110H	553004-32050H	azur dunkel
Preisgr. A216 (m ²)	Preisgr. A192 (m ²)	Preisgr. A210 (m ²)	
553006-32020H	553006-38110H	553006-32050H	blau hell
Preisgr. A216 (m ²)	Preisgr. A192 (m ²)	Preisgr. A210 (m ²)	
553007-32020H	553007-38110H	553007-32050H	blau mittel
Preisgr. A216 (m ²)	Preisgr. A192 (m ²)	Preisgr. A210 (m ²)	
553008-32020H	553008-38110H¹	553008-32050H¹	blau dunkel
Preisgr. A216 (m ²)	Preisgr. A192 (m ²)	Preisgr. A210 (m ²)	
553010-32020H	553010-38110H	553010-32050H¹	türkis hell
Preisgr. A216 (m ²)	Preisgr. A192 (m ²)	Preisgr. A210 (m ²)	
553011-32020H	553011-38110H	553011-32050H	türkis mittel
Preisgr. A216 (m ²)	Preisgr. A192 (m ²)	Preisgr. A210 (m ²)	
553014-32020H	553014-38110H¹	553014-32050H¹	grün hell
Preisgr. A216 (m ²)	Preisgr. A192 (m ²)	Preisgr. A210 (m ²)	
553015-32020H	553015-38110H	553015-32050H	grün mittel
Preisgr. A216 (m ²)	Preisgr. A192 (m ²)	Preisgr. A210 (m ²)	
553016-32020H	553016-38110H	553016-32050H	grün dunkel
Preisgr. A216 (m ²)	Preisgr. A192 (m ²)	Preisgr. A210 (m ²)	
553018-32020H¹	553018-38110H¹	553018-32050H¹	gelb hell
Preisgr. A216 (m ²)	Preisgr. A192 (m ²)	Preisgr. A210 (m ²)	
553019-32020H	553019-38110H	553019-32050H	gelb mittel
Preisgr. A216 (m ²)	Preisgr. A192 (m ²)	Preisgr. A210 (m ²)	
553023-32020H¹	553023-38110H	553023-32050H	ocker mittel
Preisgr. A216 (m ²)	Preisgr. A192 (m ²)	Preisgr. A210 (m ²)	
553026-32020H¹	553026-38110H¹	553026-32050H¹	lachs hell
Preisgr. A216 (m ²)	Preisgr. A192 (m ²)	Preisgr. A210 (m ²)	
553027-32020H¹	553027-38110H	553027-32050H	lachs mittel
Preisgr. A216 (m ²)	Preisgr. A192 (m ²)	Preisgr. A210 (m ²)	
553031-32020H	553031-38110H¹	553031-32050H¹	oxidrot mittel
Preisgr. A216 (m ²)	Preisgr. A192 (m ²)	Preisgr. A210 (m ²)	
553033-32020H¹	553033-38110H¹	553033-32050H¹	steingrau aktiv
Preisgr. A216 (m ²)	Preisgr. A192 (m ²)	Preisgr. A210 (m ²)	
553034-32020H	553034-38110H¹	553034-32050H¹	steingrau hell
Preisgr. A216 (m ²)	Preisgr. A192 (m ²)	Preisgr. A210 (m ²)	
553035-32020H	553035-38110H	553035-32050H¹	steingrau mittel
Preisgr. A216 (m ²)	Preisgr. A192 (m ²)	Preisgr. A210 (m ²)	
553036-32020H	553036-38110H	553036-32050H¹	steingrau dunkel
Preisgr. A216 (m ²)	Preisgr. A192 (m ²)	Preisgr. A210 (m ²)	

 Auftragsfertigung: Rückgabe und/oder Stornierung
bestellter Ware nicht möglich.



² Gerundete Kanten / Ecken siehe S. 341

Trittsicherheit „B“

Bodenfliesen

12,5 x 12,5 cm²



12,5 x 25 cm²



25 x 25 cm²



Lieferung als Doppel-
fliesen; müssen örtlich
gebrochen werden

Formatnummer	32020H	38110H	32050H			
Nennmaß - cm/in	12,5 x 12,5 / 5 x 5	12,5 x 25 / 5 x 10	25 x 25 / 10 x 10			
Herstellmaß	119 x 119 x 8 mm	119 x 244 x 8 mm	244 x 244 x 8 mm			
m ² - Stück	64,000	32,000	16,000			
Oberfläche	eben, seidenmatt	eben, seidenmatt	eben, seidenmatt			
m ² - kg	15,360	15,680	16,960			
Paket - Stück	66	33	14			
Paket - m ²	1,031	1,031	0,875			
Paket - kg	15,840	16,170	14,840			
Palette - m ²	86,625	86,625	70,875			
Palette - kg	1.330,500	1.358,280	1.202,040			
Produktnorm	Alb	Alb	Alb			
Trittsicherheit	-/B	-/B	-/B			
Belastung	2	2	2			
sandgrau aktiv	553037-32020H ¹ Preisgr. A216 (m ²)	553037-38110H ¹ Preisgr. A192 (m ²)	553037-32050H ¹ Preisgr. A210 (m ²)			
sandgrau hell	553038-32020H Preisgr. A216 (m ²)	553038-38110H Preisgr. A192 (m ²)	553038-32050H ¹ Preisgr. A210 (m ²)			
sandgrau mittel	553039-32020H Preisgr. A216 (m ²)	553039-38110H ¹ Preisgr. A192 (m ²)	553039-32050H ¹ Preisgr. A210 (m ²)			
sandgrau dunkel	553040-32020H Preisgr. A216 (m ²)	553040-38110H ¹ Preisgr. A192 (m ²)	553040-32050H ¹ Preisgr. A210 (m ²)			
neutral 9 (weißgrau)	553119-32020H ¹ Preisgr. A216 (m ²)	553119-38110H ¹ Preisgr. A192 (m ²)	553119-32050H Preisgr. A210 (m ²)			
neutral 8 (lichtgrau)	553118-32020H Preisgr. A216 (m ²)	553118-38110H ¹ Preisgr. A192 (m ²)	553118-32050H Preisgr. A210 (m ²)			
neutral 7 (kieselgrau)	553117-32020H Preisgr. A216 (m ²)	553117-38110H Preisgr. A192 (m ²)	553117-32050H Preisgr. A210 (m ²)			
neutral 6 (perlgrau)	553116-32020H ¹ Preisgr. A216 (m ²)	553116-38110H Preisgr. A192 (m ²)	553116-32050H ¹ Preisgr. A210 (m ²)			
neutral 5 (basaltgrau)	553115-32020H ¹ Preisgr. A216 (m ²)	553115-38110H ¹ Preisgr. A192 (m ²)	553115-32050H ¹ Preisgr. A210 (m ²)			
neutral 4 (graphitschwarz)	553114-32020H ¹ Preisgr. A216 (m ²)	553114-38110H ¹ Preisgr. A192 (m ²)	553114-32050H Preisgr. A210 (m ²)			
neutral 3 (asphaltschwarz)	553113-32020H Preisgr. A216 (m ²)	553113-38110H Preisgr. A192 (m ²)	553113-32050H Preisgr. A210 (m ²)			
neutral 2 (anthrazit)	553112-32020H Preisgr. A216 (m ²)	553112-38110H Preisgr. A192 (m ²)	553112-32050H Preisgr. A210 (m ²)			
kontrastrot	77i-32020H Preisgr. A216 (m ²)	77i-38110H Preisgr. A192 (m ²)	77i-32050H Preisgr. A210 (m ²)			



¹ Auftragsfertigung: Rückgabe und/oder Stornierung bestellter Ware nicht möglich.

Gerundete Kanten / Ecken siehe S. 341

Trittsicherheit „B“ – gerundete Kanten/Ecken^{1/2}
Bodenfliesen

12,5 x 12,5 cm



12,5 x 12,5 cm



12,5 x 25 cm



12,5 x 25 cm



12,5 x 25 cm

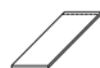

12,5 x 25 cm



gerundete Kante	gerundete Ecke	gerundete Kopfkante	gerundete Längskante	gerundete Ecke links	gerundete Ecke rechts	
32025H	32027H	38115H	38116H	38117H	38118H	Formatnummer
12,5 x 12,5 / 5 x 5	12,5 x 12,5 / 5 x 5	12,5 x 25 / 5 x 10	12,5 x 25 / 5 x 10	12,5 x 25 / 5 x 10	12,5 x 25 / 5 x 10	Nennmaß - cm/in
119 x 119 x 8 mm	119 x 119 x 8 mm	119 x 244 x 8 mm	119 x 244 x 8 mm	119 x 244 x 8 mm	119 x 244 x 8 mm	Herstellmaß
eben, seidenmatt	eben, seidenmatt	eben, seidenmatt	eben, seidenmatt	eben, seidenmatt	eben, seidenmatt	Oberfläche
0,240	0,240	0,490	0,490	0,490	0,490	m ² - Stück
66	66	33	33	33	33	Stück - kg
						Paket - Stück
						Paket - m ²
						Paket - kg
						Palette - m ²
						Palette - kg
Alb	Alb	Alb	Alb	Alb	Alb	Produktnorm
-/B	-/B	-/B	-/B	-/B	-/B	Trittsicherheit
2	2	2	2	2	2	Belastung
91i-32025H	91i-32027H	91i-38115H	91i-38116H	91i-38117H	91i-38118H	neutral 10
Preisgr. A410 (St.)	Preisgr. A410 (St.)	Preisgr. A416 (St.)	Preisgr. A416 (St.)	Preisgr. A416 (St.)	Preisgr. A416 (St.)	(aktivweiß)
340i-32025H	340i-32027H	340i-38115H	340i-38116H	340i-38117H	340i-38118H	neutral 1
Preisgr. A410 (St.)	Preisgr. A410 (St.)	Preisgr. A416 (St.)	Preisgr. A416 (St.)	Preisgr. A416 (St.)	Preisgr. A416 (St.)	(tiefschwarz)
553001-32025H	553001-32027H	553001-38115H	553001-38116H	553001-38117H	553001-38118H	
Preisgr. A410 (St.)	Preisgr. A410 (St.)	Preisgr. A416 (St.)	Preisgr. A416 (St.)	Preisgr. A416 (St.)	Preisgr. A416 (St.)	azur aktiv
553002-32025H	553002-32027H	553002-38115H	553002-38116H	553002-38117H	553002-38118H	
Preisgr. A410 (St.)	Preisgr. A410 (St.)	Preisgr. A416 (St.)	Preisgr. A416 (St.)	Preisgr. A416 (St.)	Preisgr. A416 (St.)	azur hell



25 x 25 cm



25 x 25 cm



gerundete Kante	gerundete Ecke	
32055H	32057H	Formatnummer
25 x 25 / 10 x 10	25 x 25 / 10 x 10	Nennmaß - cm/in
244 x 244 x 8 mm	244 x 244 x 8 mm	Herstellmaß
eben, seidenmatt	eben, seidenmatt	Oberfläche
1,060/Stück	1,060/m ²	m ² - Stück
14	14	St./m ² - kg
		Paket - Stück
		Paket - m ²
		Paket - kg
		Palette - m ²
		Palette - kg
Alb	Alb	Produktnorm
-/B	-/B	Trittsicherheit
2	2	Belastung
91i-32055H	91i-32057H	neutral 10
Preisgr. A434 (St.)	Preisgr. A434 (St.)	(aktivweiß)
340i-32055H	340i-32057H	neutral 1
Preisgr. A434 (St.)	Preisgr. A434 (St.)	(tiefschwarz)
553001-32055H	553001-32057H	
Preisgr. A434 (St.)	Preisgr. A434 (St.)	azur aktiv
553002-32055H	553002-32057H	
Preisgr. A434 (St.)	Preisgr. A434 (St.)	azur hell

¹ weitere Farben auf Anfrage lieferbar
² Auftragsfertigung: Rückgabe
und/oder Stornierung bestellter Ware
nicht möglich.



Gerundete Kanten				
Grundformat-Nr. statt Endziffer 0 Endziffer 7 = Ecke links	... 8 = Ecke rechts	gerundete Kanten	Beispiel: Grundformat-Nr. 38110 = 119 x 244 x 6 mm, Format-Nr. 38117 = gerundete Ecke links

Trittsicherheit „C“

-/C



weiß / neutral 10
(aktivweiß)

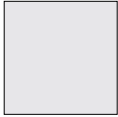

neutral 9
(weißgrau)



neutral 8
(lichtgrau)



neutral 7
(kieselgrau)



neutral 3
(asphaltschwarz)



schwarz / neutral 1
(tiefschwarz)

-/C



azur dunkel



azur mittel



azur hell



blau dunkel



blau mittel



blau hell



türkis mittel



türkis hell



grün dunkel



grün mittel



grün hell



gelb mittel



ocker mittel



lachs mittel



lachs hell



oxidrot mittel



steingrau dunkel



steingrau mittel



sandgrau dunkel



sandgrau mittel



sandgrau hell

-/C



azur aktiv

-/C



kontrastrot



Bodenfliese
12,5 x 12,5 cm



Bodenfliese
12,5 x 25 cm



Bodenfliese
25 x 25 cm

Auf Anfrage sind
weitere Farben
der Serie Chroma
als non-slip Glasur
in 6 mm Fugenbreite
lieferbar.

Trittsicherheit „C“
Bodenfliesen

12,5 x 12,5 cm²



12,5 x 25 cm²



25 x 25 cm²



Lieferung als Doppel-
fliesen; müssen örtlich
gebrochen werden



				32020H	38110H	32050H	Formatnummer
				12,5 x 12,5 / 5 x 5	12,5 x 25 / 5 x 10	25 x 25 / 10 x 10	Nennmaß - cm/in
				119 x 119 x 8 mm	119 x 244 x 8 mm	244 x 244 x 8 mm	Herstellmaß
				strukturiert, seidenmatt	strukturiert, seidenmatt	strukturiert, seidenmatt	Oberfläche
				64,000	32,000	16,000	m ² - Stück
				15,360	15,680	16,960	m ² - kg
				66	33	14	Paket - Stück
				1,031	1,031	0,875	Paket - m ²
				15,840	16,170	14,840	Paket - kg
				86,625	86,625	70,875	Palette - m ²
				1.330,560	1.358,280	1.202,040	Palette - kg
				Alb	Alb	Alb	Produktnorm
				-/C	-/C	-/C	Trittsicherheit
				⊗	⊗	⊗	Belastung
				2	2	2	neutral 10
				81i-32020H	81i-38110H	81i-32050H	(aktivweiß)
				Preisgr. A216 (m ²)	Preisgr. A192 (m ²)	Preisgr. A210 (m ²)	neutral 1
				554111-32020H	554111-38110H	554111-32050H¹	(tiefschwarz)
				Preisgr. A216 (m ²)	Preisgr. A192 (m ²)	Preisgr. A210 (m ²)	
				554001-32020H	554001-38110H	554001-32050H¹	
				Preisgr. A216 (m ²)	Preisgr. A192 (m ²)	Preisgr. A210 (m ²)	azur aktiv
				554002-32020H	554002-38110H	554002-32050H	
				Preisgr. A216 (m ²)	Preisgr. A192 (m ²)	Preisgr. A210 (m ²)	azur hell
				554003-32020H	554003-38110H	554003-32050H	
				Preisgr. A216 (m ²)	Preisgr. A192 (m ²)	Preisgr. A210 (m ²)	azur mittel
				554004-32020H	554004-38110H	554004-32050H¹	
				Preisgr. A216 (m ²)	Preisgr. A192 (m ²)	Preisgr. A210 (m ²)	azur dunkel
				554006-32020H	554006-38110H	554006-32050H¹	
				Preisgr. A216 (m ²)	Preisgr. A192 (m ²)	Preisgr. A210 (m ²)	blau hell
				554007-32020H	554007-38110H	554007-32050H¹	
				Preisgr. A216 (m ²)	Preisgr. A192 (m ²)	Preisgr. A210 (m ²)	blau mittel
				554008-32020H	554008-38110H	554008-32050H¹	
				Preisgr. A216 (m ²)	Preisgr. A192 (m ²)	Preisgr. A210 (m ²)	blau dunkel
				554010-32020H	554010-38110H	554010-32050H¹	
				Preisgr. A216 (m ²)	Preisgr. A192 (m ²)	Preisgr. A210 (m ²)	türkis hell
				554011-32020H	554011-38110H	554011-32050H¹	
				Preisgr. A216 (m ²)	Preisgr. A192 (m ²)	Preisgr. A210 (m ²)	türkis mittel
				554014-32020H	554014-38110H¹	554014-32050H¹	
				Preisgr. A216 (m ²)	Preisgr. A192 (m ²)	Preisgr. A210 (m ²)	grün hell
				554015-32020H	554015-38110H¹	554015-32050H¹	
				Preisgr. A216 (m ²)	Preisgr. A192 (m ²)	Preisgr. A210 (m ²)	grün mittel
				554016-32020H	554016-38110H	554016-32050H	
				Preisgr. A216 (m ²)	Preisgr. A192 (m ²)	Preisgr. A210 (m ²)	grün dunkel
				554019-32020H	554019-38110H	554019-32050H¹	
				Preisgr. A216 (m ²)	Preisgr. A192 (m ²)	Preisgr. A210 (m ²)	gelb mittel
				554023-32020H	554023-38110H	554023-32050H	
				Preisgr. A216 (m ²)	Preisgr. A192 (m ²)	Preisgr. A210 (m ²)	ocker mittel
				554026-32020H¹	554026-38110H¹	554026-32050H¹	
				Preisgr. A216 (m ²)	Preisgr. A192 (m ²)	Preisgr. A210 (m ²)	lachs hell
				554027-32020H	554027-38110H	554027-32050H¹	
				Preisgr. A216 (m ²)	Preisgr. A192 (m ²)	Preisgr. A210 (m ²)	lachs mittel
				554031-32020H	554031-38110H	554031-32050H¹	
				Preisgr. A216 (m ²)	Preisgr. A192 (m ²)	Preisgr. A210 (m ²)	oxidrot mittel
				554035-32020H	554035-38110H	554035-32050H¹	
				Preisgr. A216 (m ²)	Preisgr. A192 (m ²)	Preisgr. A210 (m ²)	steingrau mittel
				554036-32020H	554036-38110H	554036-32050H¹	
				Preisgr. A216 (m ²)	Preisgr. A192 (m ²)	Preisgr. A210 (m ²)	steingrau dunkel
				554038-32020H	554038-38110H	554038-32050H	
				Preisgr. A216 (m ²)	Preisgr. A192 (m ²)	Preisgr. A210 (m ²)	sandgrau hell
				554039-32020H	554039-38110H	554039-32050H¹	
				Preisgr. A216 (m ²)	Preisgr. A192 (m ²)	Preisgr. A210 (m ²)	sandgrau mittel
				554040-32020H	554040-38110H	554040-32050H¹	
				Preisgr. A216 (m ²)	Preisgr. A192 (m ²)	Preisgr. A210 (m ²)	sandgrau dunkel
				554119-32020H¹	554119-38110H	554119-32050H¹	
				Preisgr. A216 (m ²)	Preisgr. A192 (m ²)	Preisgr. A210 (m ²)	neutral 9
				554118-32020H	554118-38110H	554118-32050H¹	(weißgrau)
				Preisgr. A216 (m ²)	Preisgr. A192 (m ²)	Preisgr. A210 (m ²)	neutral 8
				554117-32020H	554117-38110H	554117-32050H	(lichtgrau)
				Preisgr. A216 (m ²)	Preisgr. A192 (m ²)	Preisgr. A210 (m ²)	neutral 7
				554113-32020H	554113-38110H	554113-32050H	(kieselgrau)
				Preisgr. A216 (m ²)	Preisgr. A192 (m ²)	Preisgr. A210 (m ²)	neutral 3
				78i-32020H	78i-38110H	78i-32050H¹	(asphaltschwarz)
				Preisgr. A216 (m ²)	Preisgr. A192 (m ²)	Preisgr. A210 (m ²)	kontrastrot

¹ Auftragsfertigung: Rückgabe und/oder Stornierung bestellter Ware nicht möglich.

² Gerundete Kanten / Ecken siehe S. 344



Trittsicherheit „C“ – gerundete Kanten/Ecken^{1/2}

Bodenfliesen



	gerundete Kante	gerundete Ecke	gerundete Kopfkante	gerundete Längskante	gerundete Ecke links	gerundete Ecke rechts
Formatnummer	32025H	32027H	38115H	38116H	38117H	38118H
Nennmaß - cm/in	12,5 x 12,5 / 5 x 5	12,5 x 12,5 / 5 x 5	12,5 x 25 / 5 x 10	12,5 x 25 / 5 x 10	12,5 x 25 / 5 x 10	12,5 x 25 / 5 x 10
Herstellmaß	119 x 119 x 8 mm	119 x 119 x 8 mm	119 x 244 x 8 mm	119 x 244 x 8 mm	119 x 244 x 8 mm	119 x 244 x 8 mm
Oberfläche	strukturiert, seidenmatt	strukturiert, seidenmatt	strukturiert, seidenmatt	strukturiert, seidenmatt	strukturiert, seidenmatt	strukturiert, seidenmatt
m ² - Stück						
Stück - kg	0,240	0,240	0,490	0,490	0,490	0,490
Paket - Stück	66	66	33	33	33	33
Paket - m ²						
Paket - kg	15,840	15,840	16,170	16,170	16,170	16,170
Palette - m ²						
Palette - kg						
Produktnorm	Alb	Alb	Alb	Alb	Alb	Alb
Trittsicherheit	-/C ☒	-/C ☒	-/C ☒	-/C ☒	-/C ☒	-/C ☒
Belastung	2	2	2	2	2	2
neutral 10 (aktivweiß)	81i-32025H Preisgr. A410 (St.)	81i-32027H Preisgr. A410 (St.)	81i-38115H Preisgr. A416 (St.)	81i-38116H Preisgr. A416 (St.)	81i-38117H Preisgr. A416 (St.)	81i-38118H Preisgr. A416 (St.)
neutral 1 (tiefschwarz)	554111-32025H Preisgr. A410 (St.)	554111-32027H Preisgr. A410 (St.)	554111-38115H Preisgr. A416 (St.)	554111-38116H Preisgr. A416 (St.)	554111-38117H Preisgr. A416 (St.)	554111-38118H Preisgr. A416 (St.)
azur aktiv	554001-32025H Preisgr. A410 (St.)	554001-32027H Preisgr. A410 (St.)	554001-38115H Preisgr. A416 (St.)	554001-38116H Preisgr. A416 (St.)	554001-38117H Preisgr. A416 (St.)	554001-38118H Preisgr. A416 (St.)
azur hell	554002-32025H Preisgr. A410 (St.)	554002-32027H Preisgr. A410 (St.)	554002-38115H Preisgr. A416 (St.)	554002-38116H Preisgr. A416 (St.)	554002-38117H Preisgr. A416 (St.)	554002-38118H Preisgr. A416 (St.)



¹ weitere Farben auf Anfrage lieferbar

² Auftragsfertigung: Rückgabe und/oder Stornierung bestellter Ware nicht möglich.

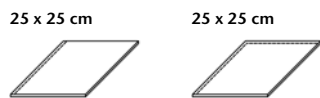

	gerundete Kante	gerundete Ecke
Formatnummer	32055H	32057H
Nennmaß - cm/in	25 x 25 / 10 x 10	25 x 25 / 10 x 10
Herstellmaß	244 x 244 x 8 mm	244 x 244 x 8 mm
Oberfläche	strukturiert, seidenmatt	strukturiert, seidenmatt
m ² - Stück		
Stück - kg	1,060	1,060
Paket - Stück	14	14
Paket - m ²		
Paket - kg	14,840	14,840
Palette - m ²		
Palette - kg		
Produktnorm	Alb	Alb
Trittsicherheit	-/C ☒	-/C ☒
Belastung	2	2
neutral 10 (aktivweiß)	81i-32055H Preisgr. A434 (St.)	81i-32057H Preisgr. A434 (St.)
neutral 1 (tiefschwarz)	554111-32055H Preisgr. A434 (St.)	554111-32057H Preisgr. A434 (St.)
azur aktiv	554001-32055H Preisgr. A434 (St.)	554001-32057H Preisgr. A434 (St.)
azur hell	554002-32055H Preisgr. A434 (St.)	554002-32057H Preisgr. A434 (St.)



¹ weitere Farben auf Anfrage lieferbar

² Auftragsfertigung: Rückgabe und/oder Stornierung bestellter Ware nicht möglich.



Gerundete Kanten

Grundformat-Nr. statt Endziffer 0 Endziffer 7 = Ecke links	... 8 = Ecke rechts	gerundete Kanten	Beispiel: Grundformat-Nr. 38110 = 119 x 244 x 6 mm, Format-Nr. 38117 = gerundete Ecke links
---	--------------------	---------------------	------------------	---



Projekt: Oasia Hotel / Standort: Singapur / Architekt: WOHA Architects + Patricia Urquiola / Serie: Chroma non-slip, Chroma / Foto: Infinitude





Quantum



weiß / neutral 10
(aktivweiß)



ocker mittel

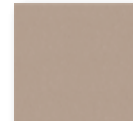

Boden-/Wandfliese
12,5 x 12,5 cm



neutral 8
(lichtgrau)



steingrau dunkel



steingrau mittel

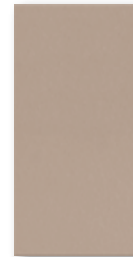

Boden-/Wandfliese
12,5 x 25 cm



neutral 7
(kieselgrau)



sandgrau dunkel



sandgrau mittel



sandgrau hell



neutral 3
(asphaltschwarz)

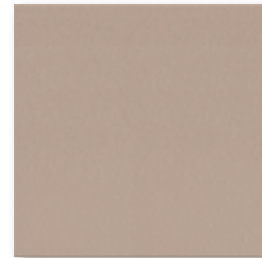

Boden-/Wandfliese
25 x 25 cm



schwarz / neutral 1
(tiefschwarz)

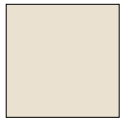

naturweiß

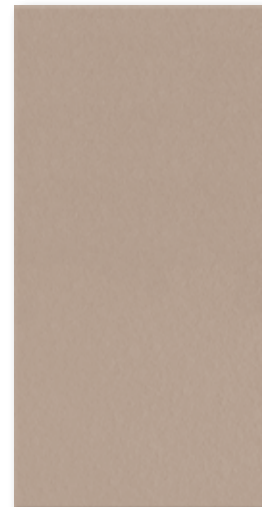

Boden-/Wandfliese
25 x 50 cm

Rasterprofil

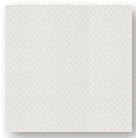

Rasterprofilfliese
12,5 x 12,5 cm

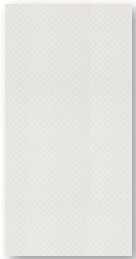

Rasterprofilfliese
12,5 x 25 cm

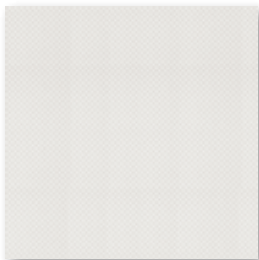

Rasterprofilfliese
25 x 25 cm

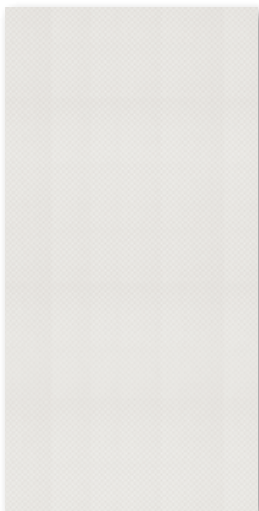

Rasterprofilfliese
25 x 50 cm

Duschtassensystem

Duschtassensystem
Ecke (einteilig)
12,5 x 12,5 cm



Duschtassensystem
Läufer
12,5 x 12,5 cm

Duschtassensystem
Läufer
25 x 12,5 cm

Kehlsockel, r = 12 mm,
25 x 12,5 cm



Außenecke,
Gehrungspaar

Innenecke,
Gehrungspaar

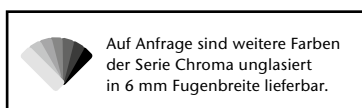

Auf Anfrage sind weitere Farben
der Serie Chroma unglasiert
in 6 mm Fugenbreite lieferbar.

Quantum

Boden-/Wandfliesen

12,5 x 12,5 cm



12,5 x 25 cm



25 x 25 cm



25 x 50 cm²



Lieferung als Doppel-
fliesen; müssen örtlich
gebrochen werden

Formatnummer	32020H	38110H	32050H	42550HK			
Nennmaß - cm/in	12,5 x 12,5 / 5 x 5	12,5 x 25 / 5 x 10	25 x 25 / 10 x 10	25 x 50 / 10 x 20			
Herstellmaß	119 x 119 x 8 mm	119 x 244 x 8 mm	244 x 244 x 8 mm	244 x 494 x 8 mm			
Oberfläche	eben, seidenmatt	eben, seidenmatt	eben, seidenmatt	eben, seidenmatt			
m ² - Stück	64,000	32,000	16,000	8,000			
m ² - kg	15,360	15,680	16,960	17,040			
Paket - Stück	66	33	14	9			
Paket - m ²	1,031	1,031	0,875	1,125			
Paket - kg	15,840	16,170	14,840	19,170			
Palette - m ²	86,625	86,625	70,875	40,500			
Palette - kg	1.330,560	1.358,280	1.202,040	690,120			
Produktnorm	Alb	Alb	Alb	Alb			
Trittsicherheit	R10/A	R10/A	R10/A	R10/A			
Belastung	2	2	2	2			
neutral 10 (aktivweiß)	926i-32020H Preisgr. A230 (m ²)	926i-38110H Preisgr. A197 (m ²)	926i-32050H Preisgr. A230 (m ²)	926i-42550HK ¹ Preisgr. A230 (m ²)			
neutral 1 (tiefschwarz)	918i-32020H Preisgr. A230 (m ²)	918i-38110H Preisgr. A197 (m ²)	918i-32050H Preisgr. A230 (m ²)	918i-42550HK ¹ Preisgr. A230 (m ²)			
ocker mittel	555023-32020H ¹ Preisgr. A230 (m ²)	555023-38110H ¹ Preisgr. A197 (m ²)	555023-32050H ¹ Preisgr. A230 (m ²)	555023-42550HK ¹ Preisgr. A230 (m ²)			
steingrau mittel	555035-32020H ¹ Preisgr. A230 (m ²)	555035-38110H ¹ Preisgr. A197 (m ²)	555035-32050H ¹ Preisgr. A230 (m ²)	555035-42550HK ¹ Preisgr. A230 (m ²)			
steingrau dunkel	555036-32020H ¹ Preisgr. A230 (m ²)	555036-38110H ¹ Preisgr. A197 (m ²)	555036-32050H ¹ Preisgr. A230 (m ²)	555036-42550HK ¹ Preisgr. A230 (m ²)			
sandgrau hell	555038-32020H ¹ Preisgr. A230 (m ²)	555038-38110H ¹ Preisgr. A197 (m ²)	555038-32050H ¹ Preisgr. A230 (m ²)	555038-42550HK ¹ Preisgr. A230 (m ²)			
sandgrau mittel	555039-32020H ¹ Preisgr. A230 (m ²)	555039-38110H ¹ Preisgr. A197 (m ²)	555039-32050H ¹ Preisgr. A230 (m ²)	555039-42550HK ¹ Preisgr. A230 (m ²)			
sandgrau dunkel	555040-32020H ¹ Preisgr. A230 (m ²)	555040-38110H ¹ Preisgr. A197 (m ²)	555040-32050H ¹ Preisgr. A230 (m ²)	555040-42550HK ¹ Preisgr. A230 (m ²)			
neutral 3 (asphaltschwarz)	555113-32020H ¹ Preisgr. A230 (m ²)	555113-38110H ¹ Preisgr. A197 (m ²)	555113-32050H ¹ Preisgr. A230 (m ²)	555113-42550HK ¹ Preisgr. A230 (m ²)			
neutral 7 (kieselgrau)	555117-32020H ¹ Preisgr. A230 (m ²)	555117-38110H ¹ Preisgr. A197 (m ²)	555117-32050H ¹ Preisgr. A230 (m ²)	555117-42550HK ¹ Preisgr. A230 (m ²)			
neutral 8 (lichtgrau)	555118-32020H ¹ Preisgr. A230 (m ²)	555118-38110H ¹ Preisgr. A197 (m ²)	555118-32050H ¹ Preisgr. A230 (m ²)	555118-42550HK ¹ Preisgr. A230 (m ²)			
naturweiß	901i-32020H Preisgr. A230 (m ²)	901i-38110H Preisgr. A197 (m ²)	901i-32050H Preisgr. A230 (m ²)	901i-42550HK ¹ Preisgr. A230 (m ²)			



¹ Auftragsfertigung: Rückgabe und/oder Stornierung bestellter Ware nicht möglich.

² rektifiziert

Quantum

Bodenfliesen/Rasterprofilfliesen

12,5 x 12,5 cm



12,5 x 25 cm



25 x 25 cm



25 x 50 cm²



Rasterprofilfliese;
Lieferung als Doppel-
fliesen; müssen örtlich
gebrochen werden



	Rasterprofilfliese	Rasterprofilfliese	Rasterprofilfliese	
32100H	34090H	32080H	42580HK	Formatnummer
12,5 x 12,5 / 5 x 5	12,5 x 25 / 5 x 10	25 x 25 / 10 x 10	25 x 50 / 10 x 20	Nennmaß - cm/in
119 x 119 x 8 mm	119 x 244 x 8 mm	244 x 244 x 8 mm	244 x 494 x 8 mm	Herstellmaß
reliefiert, seidenmatt	reliefiert, seidenmatt	reliefiert, seidenmatt	reliefiert, seidenmatt	Oberfläche
64,000	32,000	16,000	8,000	m ² - Stück
15,360	15,360	16,800	17,040	m ² - kg
66	33	14	9	Paket - Stück
1,031	1,031	0,875	1,125	Paket - m ²
15,840	15,840	14,700	19,170	Paket - kg
86,625	86,625	70,875	40,500	Palette - m ²
1.330,560	1.330,560	1.190,700	690,120	Palette - kg
Alb	Alb	Alb	Alb	Produktnorm
R11/B	R11/B	R11/B	R11/B	Trittsicherheit
2	2	2	2	Belastung
926i-32100H	926i-34090H	926i-32080H	926i-42580HK¹	neutral 10
Preisgr. A241 (m ²)	Preisgr. A216 (m ²)	Preisgr. A241 (m ²)	Preisgr. A241 (m ²)	(aktivweiß)
918i-32100H	918i-34090H	918i-32080H	918i-42580HK¹	neutral 1
Preisgr. A241 (m ²)	Preisgr. A216 (m ²)	Preisgr. A241 (m ²)	Preisgr. A241 (m ²)	(tiefschwarz)
555023-32100H¹	555023-34090H¹	555023-32080H¹	555023-42580HK¹	
Preisgr. A241 (m ²)	Preisgr. A216 (m ²)	Preisgr. A241 (m ²)	Preisgr. A241 (m ²)	ocker mittel
555035-32100H¹	555035-34090H¹	555035-32080H¹	555035-42580HK¹	
Preisgr. A241 (m ²)	Preisgr. A216 (m ²)	Preisgr. A241 (m ²)	Preisgr. A241 (m ²)	steingrau mittel
555036-32100H¹	555036-34090H¹	555036-32080H¹	555036-42580HK¹	
Preisgr. A241 (m ²)	Preisgr. A216 (m ²)	Preisgr. A241 (m ²)	Preisgr. A241 (m ²)	steingrau dunkel
555038-32100H¹	555038-34090H¹	555038-32080H¹	555038-42580HK¹	
Preisgr. A241 (m ²)	Preisgr. A216 (m ²)	Preisgr. A241 (m ²)	Preisgr. A241 (m ²)	sandgrau hell
555039-32100H¹	555039-34090H¹	555039-32080H¹	555039-42580HK¹	
Preisgr. A241 (m ²)	Preisgr. A216 (m ²)	Preisgr. A241 (m ²)	Preisgr. A241 (m ²)	sandgrau mittel
555040-32100H¹	555040-34090H¹	555040-32080H¹	555040-42580HK¹	
Preisgr. A241 (m ²)	Preisgr. A216 (m ²)	Preisgr. A241 (m ²)	Preisgr. A241 (m ²)	sandgrau dunkel
555113-32100H¹	555113-34090H¹	555113-32080H¹	555113-42580HK¹	
Preisgr. A241 (m ²)	Preisgr. A216 (m ²)	Preisgr. A241 (m ²)	Preisgr. A241 (m ²)	neutral 3
555117-32100H¹	555117-34090H¹	555117-32080H¹	555117-42580HK¹	(asphaltschwarz)
Preisgr. A241 (m ²)	Preisgr. A216 (m ²)	Preisgr. A241 (m ²)	Preisgr. A241 (m ²)	neutral 7
555118-32100H¹	555118-34090H¹	555118-32080H¹	555118-42580HK¹	(kieselgrau)
Preisgr. A241 (m ²)	Preisgr. A216 (m ²)	Preisgr. A241 (m ²)	Preisgr. A241 (m ²)	neutral 8
901i-32100H	901i-34090H	901i-32080H	901i-42580HK¹	(lichtgrau)
Preisgr. A241 (m ²)	Preisgr. A216 (m ²)	Preisgr. A241 (m ²)	Preisgr. A241 (m ²)	naturweiß

¹  Auftragsfertigung: Rückgabe und/oder Stornierung bestellter Ware nicht möglich.

²  rektifiziert



Quantum

Duschtassensystem¹

12,5 x 25 cm



Schwallkante 10 mm

12,5 x 12,5 cm



Schwallkante 10 mm

12,5 x 12,5 cm



Läufer

Läufer

Ecke

Formatnummer	27182H	27180H	27181H
Nennmaß - cm/in	12,5 x 25 / 5 x 10	12,5 x 12,5 / 5 x 5	12,5 x 12,5 / 5 x 5
Herstellmaß	119 x 244 x 18/8 mm	119 x 119 x 18/8 mm	119 x 119 x 18/8 mm
Oberfläche	eben, seidenmatt	eben, seidenmatt	eben, seidenmatt
m - Stück	4,000	8,000	
m/St. - kg	2,720/m	2,720/m	0,500/Stück
Paket - Stück	22	44	12
Paket - m	5,500	5,500	
Paket - kg	14,960	14,960	6,000
Palette - m			
Palette - kg			
Produktnorm	Alb	Alb	Alb
Trittsicherheit	R10/B	R10/B	R10/B
neutral 10 (aktivweiß)	926i-27182H Preisgr. A506 (St.)	926i-27180H Preisgr. A455 (St.)	926i-27181H Preisgr. A489 (St.)
neutral 1 (tiefschwarz)	918i-27182H Preisgr. A506 (St.)	918i-27180H Preisgr. A455 (St.)	918i-27181H Preisgr. A489 (St.)
ocker mittel	555023-27182H ² Preisgr. A506 (St.)	555023-27180H ² Preisgr. A455 (St.)	555023-27181H ² Preisgr. A489 (St.)
steingrau mittel	555035-27182H ² Preisgr. A506 (St.)	555035-27180H ² Preisgr. A455 (St.)	555035-27181H ² Preisgr. A489 (St.)
steingrau dunkel	555036-27182H ² Preisgr. A506 (St.)	555036-27180H ² Preisgr. A455 (St.)	555036-27181H ² Preisgr. A489 (St.)
sandgrau hell	555038-27182H ² Preisgr. A506 (St.)	555038-27180H ² Preisgr. A455 (St.)	555038-27181H ² Preisgr. A489 (St.)
sandgrau mittel	555039-27182H ² Preisgr. A506 (St.)	555039-27180H ² Preisgr. A455 (St.)	555039-27181H ² Preisgr. A489 (St.)
sandgrau dunkel	555040-27182H ² Preisgr. A506 (St.)	555040-27180H ² Preisgr. A455 (St.)	555040-27181H ² Preisgr. A489 (St.)
neutral 3 (asphaltschwarz)	555113-27182H ² Preisgr. A506 (St.)	555113-27180H ² Preisgr. A455 (St.)	555113-27181H ² Preisgr. A489 (St.)
neutral 7 (kieselgrau)	555117-27182H ² Preisgr. A506 (St.)	555117-27180H ² Preisgr. A455 (St.)	555117-27181H ² Preisgr. A489 (St.)
neutral 8 (lichtgrau)	555118-27182H ² Preisgr. A506 (St.)	555118-27180H ² Preisgr. A455 (St.)	555118-27181H ² Preisgr. A489 (St.)
naturweiß	901i-27182H Preisgr. A506 (St.)	901i-27180H Preisgr. A455 (St.)	901i-27181H Preisgr. A489 (St.)

¹ Details siehe S. 482

²  Auftragsfertigung: Rückgabe und/oder Stornierung bestellter Ware nicht möglich.

Diese Formstücke sind nicht durchgefärbt.

Quantum

Sicherheitsriemchen^{1/2}

6,2 x 25 cm



gerillt, Längskante
gerundet

Sockelsysteme²

7,9 x 25 cm



Sockelleiste

12,5 x 25 cm



Kehlsöckel, r = 12 mm



Außenecke
Gehrungspaar



Innenecke
Gehrungspaar



34306H	34020H	37080	37081	37082	Formatnummer
6,2 x 25 / 2 1/2 x 10	7,9 x 25 / 3 1/8 x 10	12,5 x 25 / 5 x 10			Nennmaß - cm/in
56 x 244 x 8 mm	73 x 244 x 8 mm	125 x 244/12 x 8 mm	(2x) 131 x 125/12 x 8 mm	(2x) 119 x 125/12 x 8 mm	Herstellmaß
eben, seidenmatt	eben, seidenmatt	eben, seidenmatt	eben, seidenmatt	eben, seidenmatt	Oberfläche
4,000	4,000	4,000			m - Stück
0,800/m	1,160/m	2,520/m	0,600/Paar	0,400/Paar	m/Paar - kg
66 Stück	33 Stück	20 Stück	10 Paar	10 Paar	Paket - St./Paar
16,500	8,250	5,000			Paket - m
13,200	9,570	12,600	6,000	4,000	Paket - kg
					Palette - m
					Palette - kg
Alb	Alb	Alb	Alb	Alb	Produktnorm
-/C					Trittsicherheit
	926i-34020H	926-37080	926-37081	926-37082	neutral 10
	Preisgr. A410 (St.)	Preisgr. A423 (St.)	Preisgr. A455 (Paar)	Preisgr. A455 (Paar)	(aktivweiß)
	918i-34020H	918-37080	918-37081	918-37082	neutral 1
	Preisgr. A410 (St.)	Preisgr. A423 (St.)	Preisgr. A455 (Paar)	Preisgr. A455 (Paar)	(tiefschwarz)
	901i-34020H	901-37080	901-37081	901-37082	
	Preisgr. A410 (St.)	Preisgr. A423 (St.)	Preisgr. A455 (Paar)	Preisgr. A455 (Paar)	naturweiß

¹ Besonders geeignet zur trittsicheren und deutlich wahrnehmbaren Gestaltung von (Treppen-)Kanten.

² weitere Farben auf Anfrage lieferbar

Diese Formstücke sind nicht durchgefärbt



Projekt: BLU Sport- und Freizeitbad / Standort: Potsdam, Deutschland / Architekt: GMP Gerkan, Marg und Partner, Berlin /
Serien: Chroma, Beckenkopfsystem Wiesbaden, Plural / Foto: Jochen Stüber

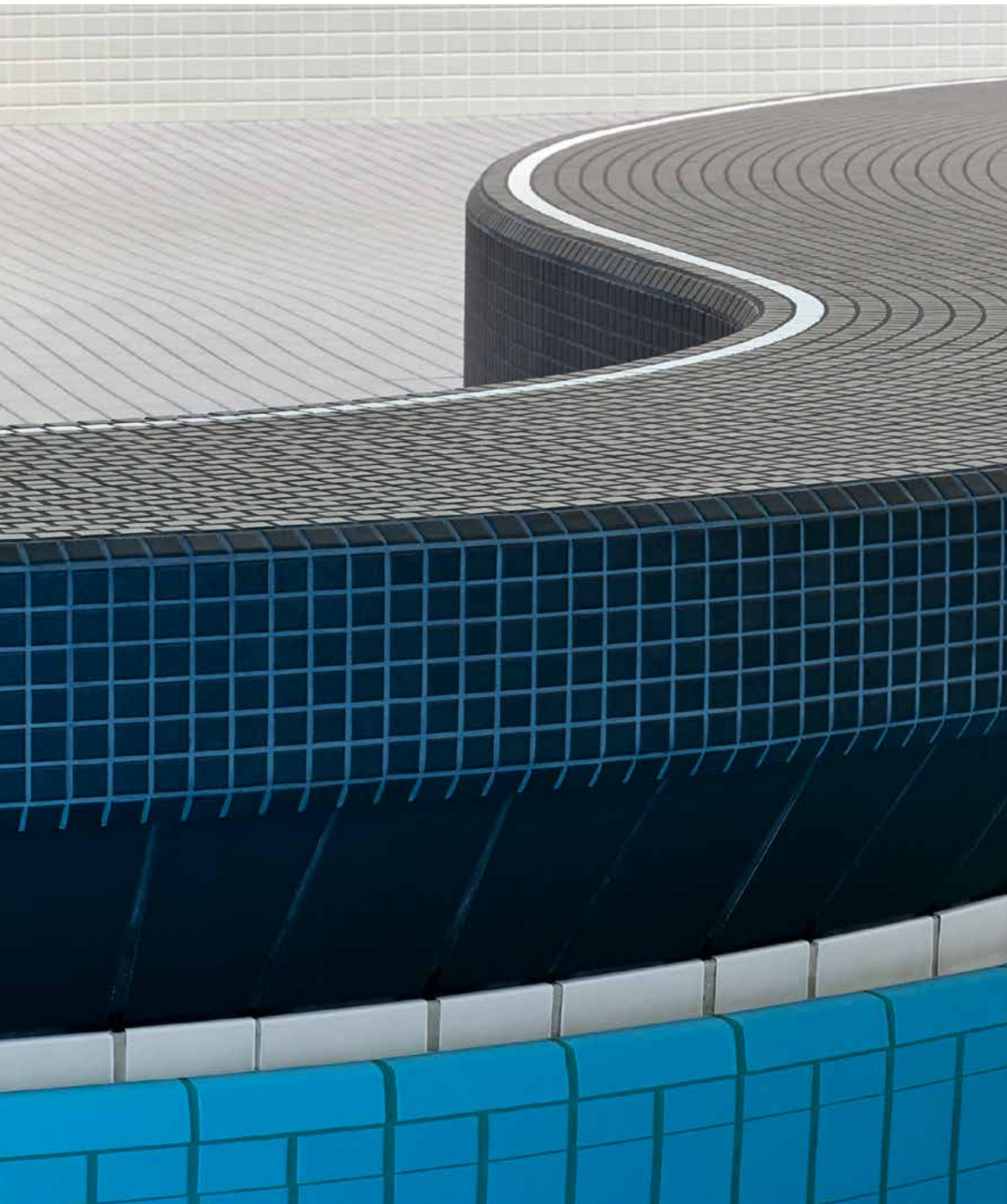



Für jedes Becken der passende Rand

Bad ist nicht gleich Bad: Unterschiedliche Nutzungsarten von Sport-, Freizeit- und Erlebnisbädern, Therapiebädern, Privat- und Hotelbädern oder Sport- und Wettkampfböcken erfordern verschiedene Beckenplanungen. Sie alle verlangen eine anspruchsvolle Gestaltung von Becken und Umgang. Das funktioniert mit modular kombinierbaren Komponenten. Neben Fliesen für die Fläche gilt dies auch für keramische Beckenrandsysteme. Sie sind aus massivem Steinzeug ohne Hohlräume gefertigt und deshalb besonders robust. Neben bewährten Klassikern umfasst das Sortiment auch Innovationen wie das Energie sparende System Bamberg.

- System Finnland I + II
- System Wiesbaden
- System Bamberg
- System St. Moritz
- System Berlin
- System Zürich
- System Skimmer

Beckenkopfsysteme im Überblick

System
Finnland

System
Finnland II

System
Wiesbaden



Schräger, strandähnlicher Beckenkopf mit Handfasse; abgedeckte Rinne mit Rinnenschale und Flüsterablauf SILENT 100.



Schräger, strandähnlicher Beckenkopf mit Handfasse und schrägem Rillenstein; abgedeckte Rinne mit Rinnenschale und Flüsterablauf SILENT 100.



Großer Rinnenstein mit Handfasse, Abdeckrost und Flüsterablauf SILENT W 2000.

Bädertyp

Sport- und Wettkampfbecken, Freizeit- und Erlebnisbäder, Freibäder.

Sport- und Wettkampfbecken, Freizeit- und Erlebnisbäder, Freibäder.

Freizeit- und Erlebnisbäder, Thermalbäder, Freibäder.

Vorteile für Nutzer und Betreiber

Geringer Wellenrückschlag durch strandähnlichen Beckenkopf; unterschiedliche Rinnenvolumen (je nach Bedarf) möglich, leichter Ausstieg durch hochliegenden Wasserspiegel.

Geringer Wellenrückschlag durch strandähnlichen Beckenkopf; unterschiedliche Rinnenvolumen (je nach Bedarf) möglich, leichter Ausstieg durch hochliegenden Wasserspiegel.

Rationale Bauart durch großen Rinnenstein, der alle Anforderungen vereint (Überlaufkante, Handfasse, Rinne, Auflager für Abdeckrost).

Varianten *

Durch 150 mm und 119 mm breite Formsteine und mehrreihiger Anordnung unterschiedlichste Breiten realisierbar, auch in Radienbereichen einsetzbar. Mit der Innenecke „Bogen“ kann die Wasserumwälzung im Eckbereichen optimiert werden. Die Ecken können bei dieser Ausführung leichter gereinigt werden. Beim Einsatz in Privatbecken auch mit keramischer Rinnenabdeckung möglich.

Schräger Rillenstein für vereinfachte Beton-Konstruktion, Reduzierung des Fugenteils bei 50 cm langen Formstücken.

Große Rinne mit Mosaikauskleidung „Flüsterrinne“ Wiesbaden Silent, kleine Rinne.

Erhältliches Zubehör

Flüsterablauf Silent 100, Agrob Buchtal Kunststoff-Abdeckroste.

Flüsterablauf Silent 100, Agrob Buchtal Kunststoff-Abdeckroste.

Flüsterablauf Silent W 2000 Querrost in Hellgrau und Weiß, Sonderfarben möglich, „Schrägroste“ zur Reduzierung von Höhenunterschieden in Treppenbereichen und Rampen.

* Sonderfarben auf Anfrage

System
Wiesbaden Stil

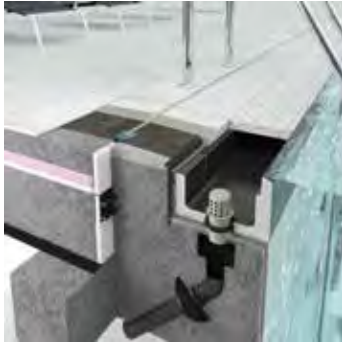

Großer Rinnenstein mit Handfasse, Keramische Rinnenabdeckung und Flüsterablauf Silent W 2000.

Privat- und Hotelbäder.

Besondere Ästhetik: Rinnenabdeckung aus Keramik in gleicher Optik wie Beckenumgangs-Belag. Ästhetisch reizvolle Ausführung der Handfasse.

Auf Anfrage auch mit Mosaikausklinkung erhältlich.

Flüsterablauf Silent W 2000.
Keramische Rinnenabdeckung 2.0.

System
Wiesbaden
tiefliegend



Großer Rinnenstein mit Handfasse.

Privat- und Hotelbäder.

Besondere Ästhetik Die tiefliegende Ausführung erlaubt eine zusätzliche „Anstauhöhe“, die vor allem für die Nutzung von Wasserattraktionen gewünscht wird. Damit eignet sich dieses System zum Beispiel optimal für Rutschenlandebecke.

Unterschiedliche Rinnenquerschnitte und Abmessungen erweitern die Einsatzmöglichkeiten, unter anderem bei erhöhten Beckenwänden in Strömungskanälen.

Flüsterablauf Silent W 2000.

System
Wiesbaden,
Therapiebecken



Kleiner Rinnenstein (ohne Abdeckrost) mit Flüsterablauf SILENT W 2000.

Therapiebecken,
Rutschenlandebecke etc.

Bei Therapieanwendungen ermöglicht das System rückenfreundliches Arbeiten mit den Patienten.

Unterschiedliche Rinnenquerschnitte und Abmessungen z. B. auch für erhöhte Beckenwände in Strömungskanälen etc.

Flüsterablauf Silent W 2000.

Beckenkopfsysteme im Überblick

System Bamberg

System St. Moritz

System Berlin



Großer Rinnenstein mit Handfasse, Ablauf (Ø 75 mm), ohne Abdeckrost.



Hochgeführtes Beckenkopfsystem mit Handfasse; Überlauf über Außenwände in Rinne mit Rostabdeckung.

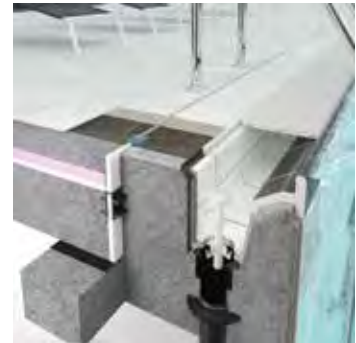

Hochliegende Überflutungskante als Handfasse; abgedeckte Rinne mit „weichem“ Einlauf.

Bädertyp

Freizeit- und Erlebnisbäder, Thermalbäder, Privat- und Hotelbäder.

Freizeit- und Erlebnisbäder, Privat- und Hotelbäder.

Freizeit- und Erlebnisbäder.

Vorteile für Nutzer und Betreiber

Durchgehende Optik bis zur Beckenkante, da keine Abdeckroste; geringer Wasserverbrauch und deutlich niedrigerer Energiebedarf; geringer Geräuschpegel; rationale Bauart durch großen Rinnenstein.

Geringere Gründungstiefen erforderlich, „erhabenes“ Becken, besonderer „Ausblick“ (Infinity Pool), unterschiedliche Rinnenvolumen (je nach Bedarf) möglich.

Überlaufrinne (Abdeckrost) grenzt unmittelbar ans Becken, daher alternative zur Wiesbadener Rinne, jedoch unterschiedliche Rinnenvolumen (je nach Bedarf) möglich.

Varianten *

Unterschiedliche Farben bei Handfasse und Rinne möglich; Sonderfarben nach Prüfung möglich.

Beliebige Beckenkopfbreiten und Randabdeckungen ausführbar.

Unterschiedliche Rinnenausführungen (Breite, Tiefe) möglich.

Erhältliches Zubehör

Flüsterablauf Silent W 2000

Flüsterablauf Silent 100, Agrob Buchtal Kunststoff-Abdeckroste.

Flüsterablauf Silent 100, Agrob Buchtal Kunststoff-Abdeckroste.

* Sonderfarben auf Anfrage

System Zürich

System Skimmer



Hochliegende Überflutungskante als Handfasse; abgedeckte Rinne mit Rinnenschale und Flüsterablauf SILENT 100.

Mit Beckenrandstein Residence.

Freizeit- und Erlebnisbäder.

Privatbäder.

Unterschiedliche Rinnenvolumen (je nach Bedarf) möglich.

„Einfacher“ Rohbetonkörper, geringer Aufwand für Wassertechnik (Anzahl Rohrleitungen).

Unterschiedliche Beckenrandsteine und Rinnenausführungen möglich.

Beckenrandausführungen mit unterschiedlichen Formsteinen möglich.

Flüsterablauf Silent 100, Agrob Buchtal Kunststoff-Abdeckroste.





Allrounder mit Strandeffekt

Das System Finland sowie dessen Variante Finland II zeichnen sich durch große Vielseitigkeit aus: Beide eignen sich bestens für Sport- und Wettkampfbecken, Erlebnis- und Freibäder. Der schräge, strandähnliche Beckenrand vermindert den Wellenrückschlag und trägt im Zusammenwirken mit dem Flüsterablauf Silent 100 dazu bei, den Geräuschpegel im Hallenbad zu senken.

System Finland (klassisch)

Das seit Jahrzehnten in unterschiedlichsten Bädern bewährte Beckenkopfsystem mit dem abgeschrägten Beckenrand verfügt über eine integrierte Handfasse und lässt sich auch in Radialbereichen verwenden. Durch den hochliegenden Wasserspiegel erleichtert es Badbenutzern den Ausstieg. Je nach Bedarf sind unterschiedliche Rinnenvolumen möglich.

Finnland (klassisch)

Durch Formsteine in den Breiten 150 und 119 mm und mehrreihige Anordnung können unterschiedlichste Breiten realisiert werden. Als Zubehör stehen der Flüsterablauf Silent 100 und Abdeckroste aus Kunststoff zur Verfügung. Beim Einsatz im Privatbecken kann auch eine keramische Rinnenabdeckung verwendet werden.

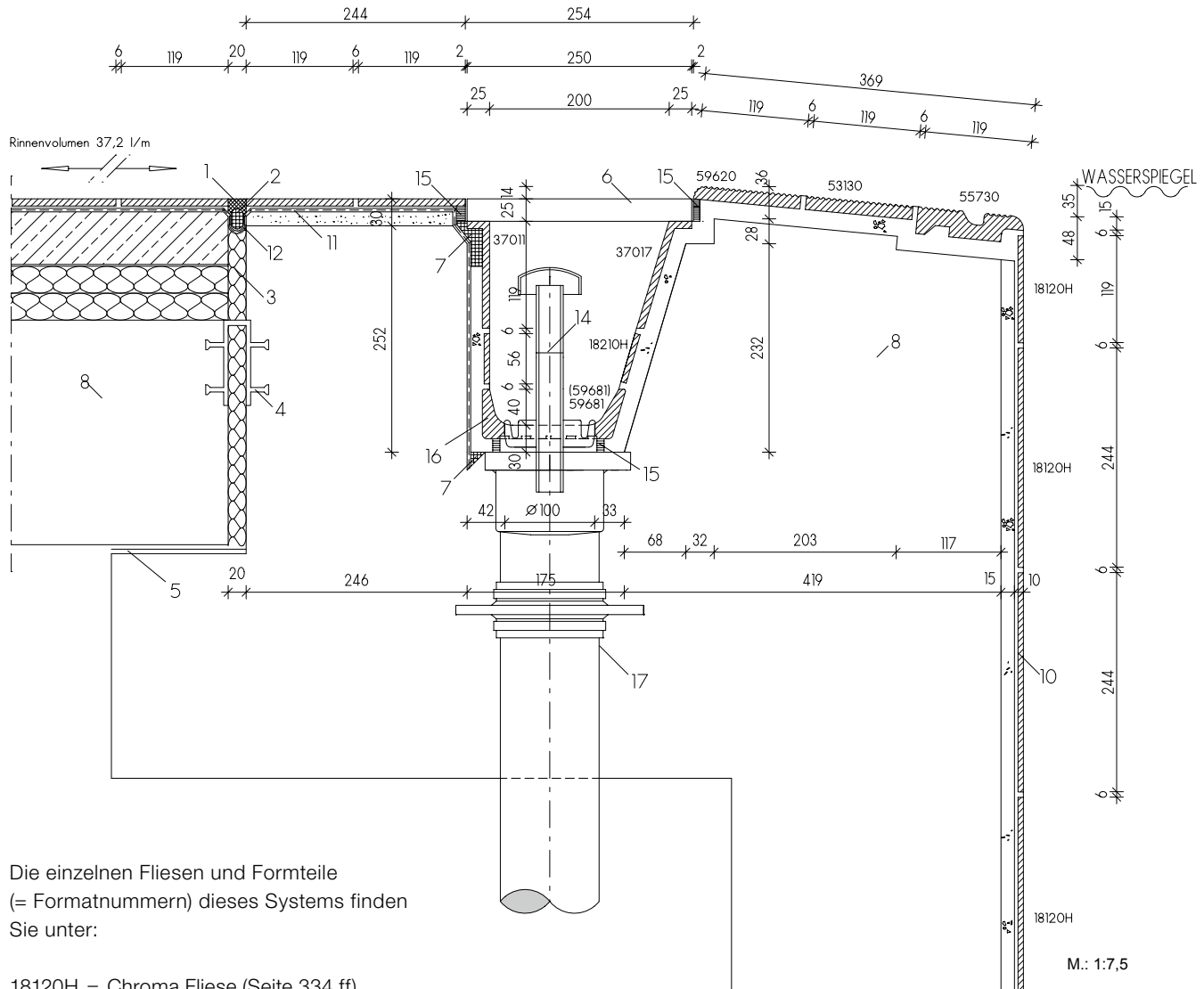

Die einzelnen Fliesen und Formteile
(= Formatnummern) dieses Systems finden
Sie unter:

- 18120H = Chroma Fliese (Seite 334 ff)
- 55730 = Handfass-Stein (Seite 361)
- 53130 = Rillenplatte (Seite 426)
- 59620 = Rillenplatte (Seite 427)
- 37017 = schräge Schenkelplatte (Seite 433)
- 18210H = Chroma Riemchen (Seite 334 ff)
- 59681 = Rinnenschale mit Ablauf (Seite 433)
- 37011 = Schenkelplatte (Seite 433)
- Abdeckrost (Seite 442)
- Flüsterablauf Silent 100 (Seite 444)

Legende:

- 01 UW-Silikon
- 02 Geschlossenzellige PE-Schaumstoffrundschnur
- 03 Wasserbeständiges elastisches Füllmaterial
- 04 Fugenband-Profil
- 05 Gleitlager
- 06 Agrob Buchtal Kunststoff-Abdeckrost

- 07 Kapillarsperre Verguss (Verwahrung)
- 08 Beton mit hohem Wassereindringwiderstand
(nach DIN EN 206/DIN
1045/DAfStB-WU-Richtlinie)
- 09 Konventionelle Dickbettverlegung
- 10 Dünnbettverlegung auf Zementputz
(P III, CS IV ohne Kalkzusatz) (DIN 18157)
- 11 Verbundabdichtung
- 12 Dichtband
- 13 Agrob Buchtal Flüsterablauf
„Silent W 2000“
- 14 Agrob Buchtal Ablaufbelüfter „Silent 100“
- 15 Objekt Fugenepoxi
- 16 Agrob Buchtal Steinzeug-Rinnenschale
- 17 Einlaufkasten/Ablaufrohr und Dichtflansch

Handfass-Stein (119 mm breit) mit non-slip-Sicherheitsmarkierung

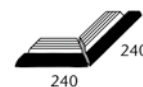
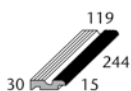

Handfass-Stein	„halber“ Handfass-Stein	Endstein links Eckradius 30 mm	Endstein rechts Eckradius 30 mm	Innenecke (Gehrungspaar)	Außenecke (Gehrungspaar) Eckradius 30 mm	Art. Nr. 55730
55730	55735	55737	55738	55732	55736	Formatnummer
244 x 119 x 15/30 mm	119 x 119 x 15/30	244 x 119 x 15/30	244 x 119 x 15/30	(2x) 112 x 112 x 15/30	(2x) 240 x 119 x 15/30	Nennmaß - cm
4,000	8,000					Herstellmaß mm
1,450/Stück	0,700/Stück	1,400/Stück	1,400/Stück	0,700/Paar	2,000/Paar	m - Stück
12 Stück	24 Stück	12 Stück	12 Stück	24 Paar	6 Paar	St./Paar - kg
3,000	3,000					Paket - St./Paar
17,400	16,800	16,800	16,800	16,800	12,000	Paket - m
						Paket - kg
						Palette - m
						Palette - kg
Alb	Alb	Alb	Alb	Alb	Alb	Produktnorm
-/C	-/C	-/C	-/C	-/C	-/C	Trittsicherheit
553001-55730	553001-55735	553001-55737	553001-55738	553001-55732	553001-55736	900 graubeige
Preisgr. A487 (St.)	Preisgr. A452 (St.)	Preisgr. A506 (St.)	Preisgr. A506 (St.)	Preisgr. A547 (Paar)	Preisgr. A615 (Paar)	553001 azur aktiv
553002-55730	553002-55735	553002-55737	553002-55738	553002-55732	553002-55736	900 graubeige
Preisgr. A487 (St.)	Preisgr. A452 (St.)	Preisgr. A506 (St.)	Preisgr. A506 (St.)	Preisgr. A547 (Paar)	Preisgr. A615 (Paar)	553002 azur hell
340-55730	340-55735	340-55737	340-55738	340-55732	340-55736	900 graubeige
Preisgr. A487 (St.)	Preisgr. A452 (St.)	Preisgr. A506 (St.)	Preisgr. A506 (St.)	Preisgr. A547 (Paar)	Preisgr. A615 (Paar)	340 n1/schwarz
900567-55730	900567-55735	900567-55737	900567-55738	900567-55732	900567-55736	91 n10/weiß
Preisgr. A511 (St.)	Preisgr. A467 (St.)	Preisgr. A528 (St.)	Preisgr. A528 (St.)	Preisgr. A587 (Paar)	Preisgr. A645 (Paar)	553001 azur aktiv
900588-55730	900588-55735	900588-55737	900588-55738	900588-55732	900588-55736	91 n10/weiß
Preisgr. A511 (St.)	Preisgr. A467 (St.)	Preisgr. A528 (St.)	Preisgr. A528 (St.)	Preisgr. A587 (Paar)	Preisgr. A645 (Paar)	553002 azur hell
900044-55730	900044-55735	900044-55737	900044-55738	900044-55732	900044-55736	91 n10/weiß
Preisgr. A511 (St.)	Preisgr. A467 (St.)	Preisgr. A528 (St.)	Preisgr. A528 (St.)	Preisgr. A587 (Paar)	Preisgr. A645 (Paar)	340 n1/schwarz



Handfass-Stein (150 mm breit) mit non-slip-Sicherheitsmarkierung

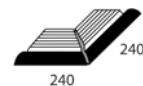
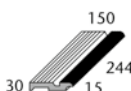

Handfass-Stein	„halber“ Handfass-Stein	Endstein links Eckradius 30 mm	Endstein rechts Eckradius 30 mm	Innenecke (Gehrungspaar)	Außenecke (Gehrungspaar) Eckradius 30 mm	Art. Nr. 59420
59420	59425	59427	59428	59422	59426	Formatnummer
244 x 150 x 15/30	119 x 150 x 15/30	244 x 150 x 15/30	244 x 150 x 15/30	(2x) 143 x 143 x 15/30	(2x) 240 x 150 x 15/30	Nennmaß - cm
4,000	8,000					Herstellmaß mm
1,600/Stück	0,790/Stück	1,600/Stück	1,600/Stück	1,000/Paar	2,100/Paar	m - Stück
12 Stück	24 Stück	12 Stück	12 Stück	12 Paar	6 Paar	St./Paar - kg
3,000	3,000					Paket - St./Paar
19,200	18,960	19,200	19,200	12,000	12,600	Paket - m
						Paket - kg
						Palette - m
						Palette - kg
Alb	Alb	Alb	Alb	Alb	Alb	Produktnorm
-/C	-/C	-/C	-/C	-/C	-/C	Trittsicherheit
553001-59420	553001-59425	553001-59427	553001-59428	553001-59422	553001-59426	900 graubeige
Preisgr. A511 (St.)	Preisgr. A467 (St.)	Preisgr. A528 (St.)	Preisgr. A528 (St.)	Preisgr. A587 (Paar)	Preisgr. A645 (Paar)	553001 azur aktiv
553002-59420	553002-59425	553002-59427	553002-59428	553002-59422	553002-59426	900 graubeige
Preisgr. A511 (St.)	Preisgr. A467 (St.)	Preisgr. A528 (St.)	Preisgr. A528 (St.)	Preisgr. A587 (Paar)	Preisgr. A645 (Paar)	553002 azur hell
340-59420	340-59425	340-59427	340-59428	340-59422	340-59426	900 graubeige
Preisgr. A511 (St.)	Preisgr. A467 (St.)	Preisgr. A528 (St.)	Preisgr. A528 (St.)	Preisgr. A587 (Paar)	Preisgr. A645 (Paar)	340 n1/schwarz
900567-59420	900567-59425	900567-59427	900567-59428	900567-59422	900567-59426	91 n10/weiß
Preisgr. A533 (St.)	Preisgr. A487 (St.)	Preisgr. A560 (St.)	Preisgr. A560 (St.)	Preisgr. A618 (Paar)	Preisgr. A668 (Paar)	553001 azur aktiv
900588-59420	900588-59425	900588-59427	900588-59428	900588-59422	900588-59426	91 n10/weiß
Preisgr. A533 (St.)	Preisgr. A487 (St.)	Preisgr. A560 (St.)	Preisgr. A560 (St.)	Preisgr. A618 (Paar)	Preisgr. A668 (Paar)	553002 azur hell
900044-59420	900044-59425	900044-59427	900044-59428	900044-59422	900044-59426	91 n10/weiß
Preisgr. A533 (St.)	Preisgr. A487 (St.)	Preisgr. A560 (St.)	Preisgr. A560 (St.)	Preisgr. A618 (Paar)	Preisgr. A668 (Paar)	340 n1/schwarz

¹ Abdeckkroste siehe S. 442, Rinnenschale siehe S. 433

Für die auf dieser Seite gezeigten Produkte wird kein Palettenrabatt gewährt.



Die dargestellten Produkte können auch in anderen Farben der Serie Chroma non-slip gefertigt werden. Gerne prüfen wir die Möglichkeit einer solchen Sonderproduktion im Einzelfall.



Handfass-Stein und Randstein (140 mm breit) mit Rostaufleger und non-slip-Sicherheitsmarkierung

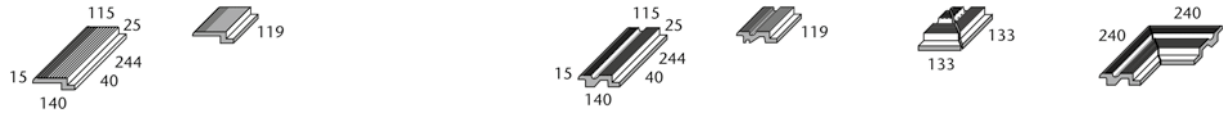

	Randstein zu Art. 55760	Randstein zu Art. 55775	Handfass-Stein	„halber“ Handfass-Stein	Innenecke (Gehrungspaar)	Außenecke (Gehrungspaar) Eckradius 30 mm
Formatnummer	55770	55775	55760	55765	55762	55766
Nennmaß - cm						
Herstellmaß mm	244 x 140 x 15/40	119 x 140 x 15/40	244 x 140 x 15/40	119 x 140 x 15/40	(2x) 133 x 133 x 15/40	(2x) 240 x 140 x 15/40
m - Stück	4,000	8,000	4,000	8,000		
St./Paar - kg	1,300/Stück	0,780/Stück	1,550/Stück	0,780/Stück	1,000/Paar	2,300/Paar
Paket - St./Paar	12 Stück	24 Stück	9 Stück	18 Stück	2 Paar	4 Paar
Paket - m	3,000	3,000	2,250	2,250		
Paket - kg	15,600	16,720	13,950	14,040	2,000	9,200
Palette - m						
Palette - kg						
Produktnorm	Alb	Alb	Alb	Alb	Alb	Alb
Trittsicherheit	-/C	-/C	-/C	-/C	-/C	-/C
900 graubeige	553001-55770	553001-55775	553001-55760	553001-55765	553001-55762	553001-55766
553001 azur aktiv	Preisgr. A489 (St.)	Preisgr. A452 (St.)	Preisgr. A556 (St.)	Preisgr. A452 (St.)	Preisgr. A645 (Paar)	Preisgr. A683 (Paar)
900 graubeige	553002-55770	553002-55775	553002-55760	553002-55765	553002-55762	553002-55766
553002 azur hell	Preisgr. A489 (St.)	Preisgr. A452 (St.)	Preisgr. A556 (St.)	Preisgr. A452 (St.)	Preisgr. A645 (Paar)	Preisgr. A683 (Paar)
900 graubeige	340-55770	340-55775	340-55760	340-55765	340-55762	340-55766
340 n1/schwarz	Preisgr. A489 (St.)	Preisgr. A452 (St.)	Preisgr. A556 (St.)	Preisgr. A452 (St.)	Preisgr. A645 (Paar)	Preisgr. A683 (Paar)
91 n10/weiß	900567-55770	900567-55775	900567-55760	900567-55765	900567-55762	900567-55766
553001 azur aktiv	Preisgr. A506 (St.)	Preisgr. A463 (St.)	Preisgr. A577 (St.)	Preisgr. A463 (St.)	Preisgr. A668 (Paar)	Preisgr. A705 (Paar)
91 n10/weiß	900588-55770	900588-55775	900588-55760	900588-55765	900588-55762	900588-55766
553002 azur hell	Preisgr. A506 (St.)	Preisgr. A463 (St.)	Preisgr. A577 (St.)	Preisgr. A463 (St.)	Preisgr. A668 (Paar)	Preisgr. A705 (Paar)
91 n10/weiß	900044-55770	900044-55775	900044-55760	900044-55765	900044-55762	900044-55766
340 n1/schwarz	Preisgr. A506 (St.)	Preisgr. A463 (St.)	Preisgr. A577 (St.)	Preisgr. A463 (St.)	Preisgr. A668 (Paar)	Preisgr. A705 (Paar)



Randstein mit non-slip-Sicherheitsmarkierung

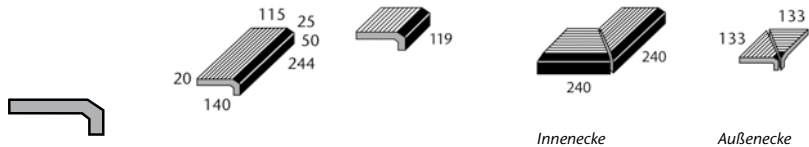

	Randstein	„halber“ Randstein	Innenecke (Gehrungspaar)	Außenecke (Gehrungspaar)
Formatnummer	55720	55725	55722	55729
Nennmaß - cm				
Herstellmaß mm	244 x 140 x 20/50	119 x 140 x 20/50	(2x) 240 x 140 x 20/50	(2x) 133 x 133 x 20/50
m - Stück	4,000	8,000		
St./Paar - kg	1,500/Stück	0,730/Stück	2,200/Paar	0,700/Paar
Paket - St./Paar	10 Stück	20 Stück	5 Paar	4 Paar
Paket - m	2,500	2,500		
Paket - kg	15,000	14,600	11,000	2,800
Palette - m				
Palette - kg				
Produktnorm	Alb	Alb	Alb	Alb
Trittsicherheit	-/C	-/C	-/C	-/C
900 graubeige	553001-55720	553001-55725	553001-55722	553001-55729
553001 azur aktiv	Preisgr. A528 (St.)	Preisgr. A480 (St.)	Preisgr. A668 (Paar)	Preisgr. A604 (Paar)
900 graubeige	553002-55720	553002-55725	553002-55722	553002-55729
553002 azur hell	Preisgr. A528 (St.)	Preisgr. A480 (St.)	Preisgr. A668 (Paar)	Preisgr. A604 (Paar)
900 graubeige	340-55720	340-55725	340-55722	340-55729
340 n1/schwarz	Preisgr. A528 (St.)	Preisgr. A480 (St.)	Preisgr. A668 (Paar)	Preisgr. A604 (Paar)
91 n10/weiß	900567-55720	900567-55725	900567-55722	900567-55729
553001 azur aktiv	Preisgr. A556 (St.)	Preisgr. A506 (St.)	Preisgr. A708 (Paar)	Preisgr. A636 (Paar)
91 n10/weiß	900588-55720	900588-55725	900588-55722	900588-55729
553002 azur hell	Preisgr. A556 (St.)	Preisgr. A506 (St.)	Preisgr. A708 (Paar)	Preisgr. A636 (Paar)
91 n10/weiß	900044-55720	900044-55725	900044-55722	900044-55729
340 n1/schwarz	Preisgr. A556 (St.)	Preisgr. A506 (St.)	Preisgr. A708 (Paar)	Preisgr. A636 (Paar)

¹ Abdeckrolle siehe S. 422



Für die auf dieser Seite gezeigten Produkte wird kein Palettenrabatt gewährt.

Die dargestellten Produkte können auch in anderen Farben der Serie Chroma non-slip gefertigt werden. Gerne prüfen wir die Möglichkeit einer solchen Sonderproduktion im Einzelfall.

Randsteine mit Rostaufleger und non-slip-Sicherheitsmarkierung

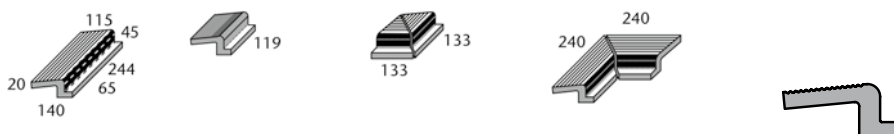

			Randstein	„halber“ Randstein	Innenecke (Gehrungspaar)	Außenecke (Gehrungspaar)	Art. Nr. 55740
			55740	55745	55742	55749	Formatnummer
			244 x 140 x 20/65	119 x 140 x 20/65	(2x) 133 x 133 x 20/65	(2x) 240 x 140 x 20/65	Nennmaß - cm
			4,000	8,000			Herstellmaß mm
			1,850/Stück	0,900/Stück	0,900/Paar	2,700/Paar	m - Stück
			6 Stück	12 Stück	4 Paar	3 Paar	St./Paar - kg
			1,500	1,500			Paket - St./Paar
			11,100	10,800	3,600	8,100	Paket - m
							Paket - kg
							Palette - m
							Palette - kg
			Alb	Alb	Alb	Alb	Produktnorm
			-/C	-/C	-/C	-/C	Trittsicherheit
			553001-55740	553001-55745	553001-55742	553001-55749	900 graubeige
			Preisgr. A556 (St.)	Preisgr. A506 (St.)	Preisgr. A645 (Paar)	Preisgr. A683 (Paar)	553001 azur aktiv
			553002-55740	553002-55745	553002-55742	553002-55749	900 graubeige
			Preisgr. A556 (St.)	Preisgr. A506 (St.)	Preisgr. A645 (Paar)	Preisgr. A683 (Paar)	553002 azur hell
			340-55740	340-55745	340-55742	340-55749	900 graubeige
			Preisgr. A556 (St.)	Preisgr. A506 (St.)	Preisgr. A645 (Paar)	Preisgr. A683 (Paar)	340 n1/schwarz
			900567-55740	900567-55745	900567-55742	900567-55749	91 n10/weiß
			Preisgr. A577 (St.)	Preisgr. A511 (St.)	Preisgr. A668 (Paar)	Preisgr. A708 (Paar)	553001 azur aktiv
			900588-55740	900588-55745	900588-55742	900588-55749	91 n10/weiß
			Preisgr. A577 (St.)	Preisgr. A511 (St.)	Preisgr. A668 (Paar)	Preisgr. A708 (Paar)	553002 azur hell
			900044-55740	900044-55745	900044-55742	900044-55749	91 n10/weiß
			Preisgr. A577 (St.)	Preisgr. A511 (St.)	Preisgr. A668 (Paar)	Preisgr. A708 (Paar)	340 n1/schwarz



Randsteine mit Rostaufleger

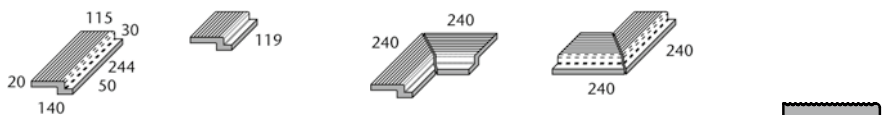

			Randstein	„halber“ Randstein	Innenecke (Gehrungspaar)	Außenecke (Gehrungspaar)	Art. Nr. 55750
			55750	55755	55752	55759	Formatnummer
			244 x 140 x 20/50	119 x 140 x 20/50	(2x) 240 x 140 x 20/50	(2x) 240 x 140 x 20/50	Nennmaß - cm
			4,000	8,000			Herstellmaß mm
			1,780/Stück	0,880/Stück	2,600/Paar	2,600/Paar	m - Stück
			8 Stück	16 Stück	4 Paar	4 Paar	St./Paar - kg
			2,000	2,000			Paket - St./Paar
			14,240	14,080	10,400	10,400	Paket - m
							Paket - kg
							Palette - m
							Palette - kg
			Alb	Alb	Alb	Alb	Produktnorm
			-/C	-/C	-/C	-/C	Trittsicherheit
			900-55750	900-55755	900-55752	900-55759	graubeige
			Preisgr. A539 (St.)	Preisgr. A487 (St.)	Preisgr. A663 (Paar)	Preisgr. A663 (Paar)	neutral 10
			91-55750	91-55755	91-55752	91-55759	(aktivweiß)
			A560 (St.)	Preisgr. A506 (St.)	Preisgr. A689 (Paar)	Preisgr. A689 (Paar)	

¹ Abdeckroste siehe S. 442

Für die auf dieser Seite gezeigten Produkte wird kein Palettenrabatt gewährt.



Die dargestellten Produkte können auch in anderen Farben der Serie Chroma non-slip gefertigt werden. Gerne prüfen wir die Möglichkeit einer solchen Sonderproduktion im Einzelfall.

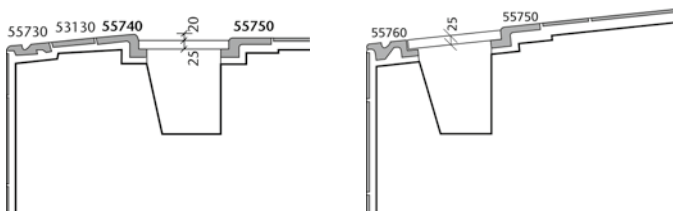





Ein Klassiker neu gedacht

Die Weiterentwicklung des weltweit verbreiteten Klassikers Finnland (vgl. S. 360 ff) ist ebenso universell einsetzbar. Ein wichtiger Unterschied im Detail ist der abgeschrägte Rillenstein. Sein keilförmiger Längsschnitt erleichtert die Erstellung der Betonkonstruktion entscheidend: Die Oberseite der Beckenwand kann waagrecht ausgeführt werden. Für das nötige Gefälle zum Becken hin sorgt dann der Rillenstein. Reduzierter Wellenschlag und der hochliegende Wasserspiegel sorgen auch hier für erhöhten Komfort beim Schwimmen und beim Verlassen des Beckens. Für Finnland II sprechen auch die 500 mm langen Formstücke, die den Fugenanteil senken. Statt der Standard Abdeckroste aus Kunststoff ist bei privaten Pools auch der Einsatz von keramischen Rinnenabdeckungen möglich (siehe System Wiesbaden Stil auf S. 380 ff).

Finnland II (Rillenstein schräg)

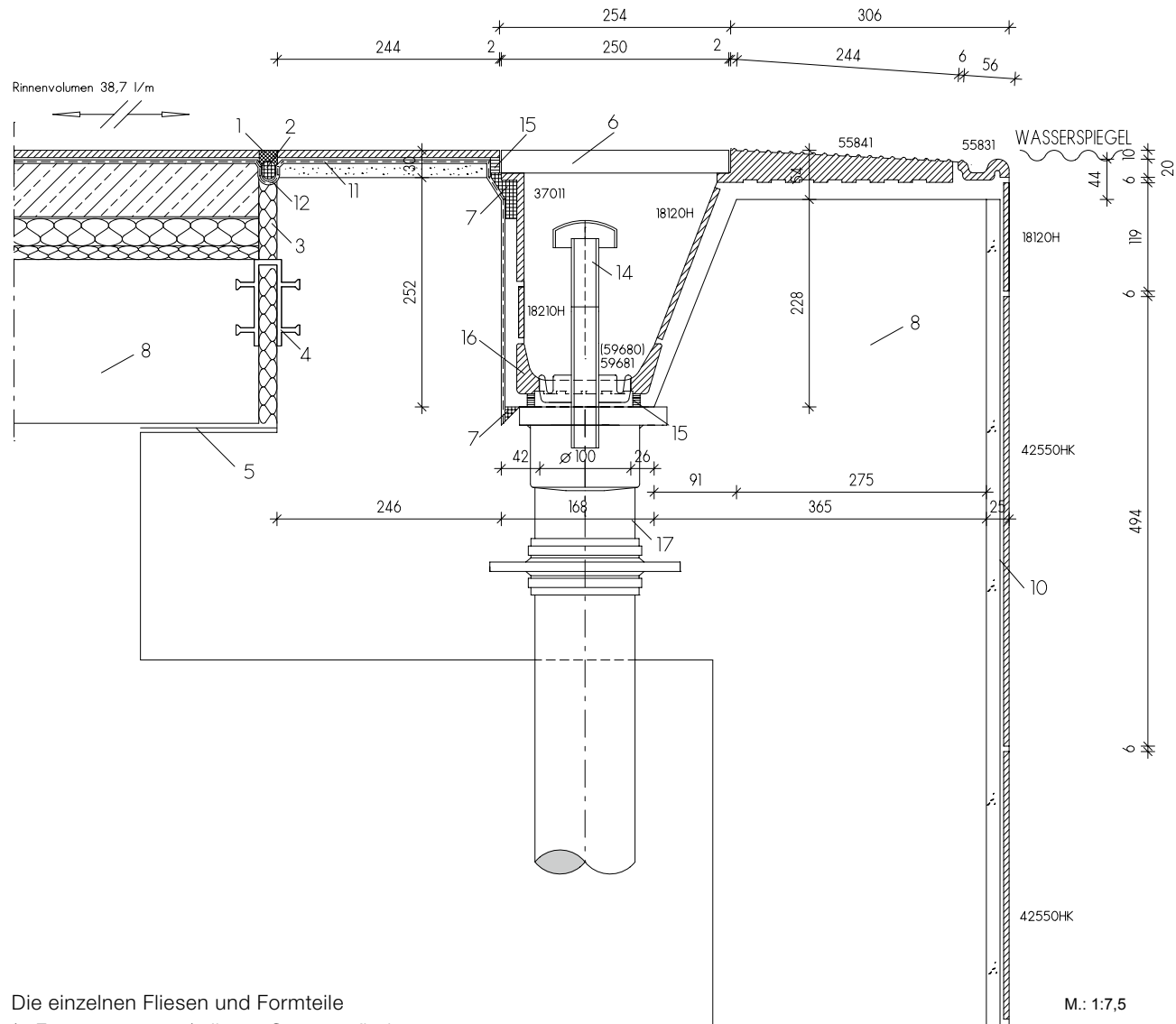

Die einzelnen Fliesen und Formteile
(= Formatnummern) dieses Systems finden
Sie unter:

- 42550HK = Chroma Fliese (Seite 334 ff)
 - 55831 = Handfaßstein (Seite 367)
 - 55841 = schräger Rinnenstein (Seite 368)
 - 18120H = Chroma Fliese (Seite 334 ff)
 - 59681 = Rinnenschale mit Ablauf (Seite 433)
 - 18210H = Chroma Riemchen (Seite 334 ff)
 - 37011 = Schenkelplatte (Seite 433)
 - Abdeckrost (Seite 442)
 - Flüsterablauf Silent 100 (Seite 444)
- Legende:**
- 01 UW-Silikon
 - 02 Geschlossenzellige PE-Schaumstoffrundschnur
 - 03 Wasserbeständiges elastisches Füllmaterial
 - 04 Fugenband-Profil
 - 05 Gleitlager

- 06 Agrob Buchtal Kunststoff-Abdeckrost
- 07 Kapillarsperre Verguss (Verwahrung)
- 08 Beton mit hohem Wassereindringwiderstand
(nach DIN EN 206/DIN
1045/DAfStB-WU-Richtlinie)
- 09 Konventionelle Dickbettverlegung
- 10 Dünnbettverlegung auf Zementputz
(P III, CS IV ohne Kalkzusatz) (DIN 18157)
- 11 Verbundabdichtung
- 12 Dichtband
- 13 Agrob Buchtal Flüsterablauf
„Silent W 2000“
- 14 Agrob Buchtal Ablaufbelüfter „Silent 100“
- 15 Objekt Fugenepxi
- 16 Agrob Buchtal Steinzeug-Rinnenschale
- 17 Einlaufkasten/Ablaufrohr und Dichtflansch

Handfass-Stein



	Handfass-Stein 50 cm	Handfass-Stein 25 cm	Handfass-Stein 12,5 cm	Innenecke (Gehrungspaar)	Außenecke (Gehrungspaar) Eckradius 30 mm	Art. Nr. 55830
	55831	55830	55835	55832	55836	Formatnummer
	494 x 56 x 20/12,5	244 x 56 x 20/12,5	119 x 56 x 20/12,5	(2x) 49 x 49 x 20/12,5	(2x) 236 x 56 x 20/12,5	Nennmaß - cm
	2,000	4,000	8,000			Herstellmaß mm
	0,910/Stück	0,450/Stück	0,220/Stück	0,080/Paar	0,790/Paar	m - Stück
	8 Stück	28 Stück	56 Stück	18 Paar	14 Paar	St./Paar - kg
	4,000	7,000	7,000			Paket - St./Paar
	7,280	12,600	12,320	1,440	11,060	Paket - m
						Paket - kg
						Palette - m
						Palette - kg
	Alb	Alb	Alb	Alb	Alb	Produktnorm
	-/C	-/C	-/C	-/C	-/C	Trittsicherheit
	553001-55831	553001-55830	553001-55835	553001-55832	553001-55836	azur aktiv
	Preisgr. A514 (St.)	Preisgr. A471 (St.)	Preisgr. A441 (St.)	Preisgr. A519 (Paar)	Preisgr. A581 (Paar)	
	553002-55831	553002-55830	553002-55835	553002-55832	553002-55836	azur hell
	Preisgr. A514 (St.)	Preisgr. A471 (St.)	Preisgr. A441 (St.)	Preisgr. A519 (Paar)	Preisgr. A581 (Paar)	
	340-55831	340-55830	340-55835	340-55832	340-55836	neutral 1
	Preisgr. A514 (St.)	Preisgr. A471 (St.)	Preisgr. A441 (St.)	Preisgr. A519 (Paar)	Preisgr. A581 (Paar)	(tiefschwarz)



Randstein, Treppenauftritt

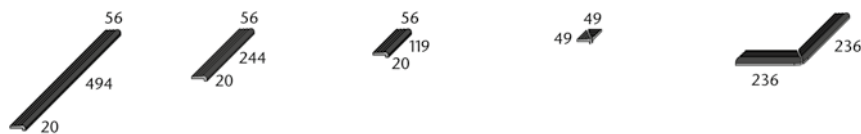

	Randstein 50 cm	Randstein 25 cm	Randstein 12,5 cm	Innenecke (Gehrungspaar)	Außenecke (Gehrungspaar) Eckradius 30 mm	Art. Nr. 55820
	55821	55820	55825	55822	55826	Formatnummer
	494 x 56 x 20/12,5	244 x 56 x 20/12,5	119 x 56 x 20/12,5	(2x) 49 x 49 x 20/12,5	(2x) 236 x 56 x 20/12,5	Nennmaß - cm
	2,000	4,000	8,000			Herstellmaß mm
	0,770/Stück	0,380/Stück	0,190/Stück	0,100/Paar	0,620/Paar	m - Stück
	12 Stück	42 Stück	84 Stück	18 Paar	14 Paar	St./Paar - kg
	6,000	10,500	10,500			Paket - St./Paar
	9,240	15,960	15,960	1,440	11,060	Paket - m
						Paket - kg
						Palette - m
						Palette - kg
	Alb	Alb	Alb	Alb	Alb	Produktnorm
	-/C	-/C	-/C	-/C	-/C	Trittsicherheit
	553001-55821	553001-55820	553001-55825	553001-55822	553001-55826	azur aktiv
	Preisgr. A475 (St.)	Preisgr. A441 (St.)	Preisgr. A425 (St.)	Preisgr. A484 (Paar)	Preisgr. A528 (Paar)	
	553002-55821	553002-55820	553002-55825	553002-55822	553002-55826	azur hell
	Preisgr. A475 (St.)	Preisgr. A441 (St.)	Preisgr. A425 (St.)	Preisgr. A484 (Paar)	Preisgr. A528 (Paar)	
	340-55821	340-55820	340-55825	340-55822	340-55826	neutral 1
	Preisgr. A475 (St.)	Preisgr. A441 (St.)	Preisgr. A425 (St.)	Preisgr. A484 (Paar)	Preisgr. A528 (Paar)	(tiefschwarz)

¹ Abdeckkroste siehe S. 442, Rinnenschale siehe S. 433

Für die auf dieser Seite gezeigten Produkte wird kein Palettenrabatt gewährt.



Die dargestellten Produkte können auch in anderen Farben der Serie Chroma non-slip gefertigt werden. Gerne prüfen wir die Möglichkeit einer solchen Sonderproduktion im Einzelfall.

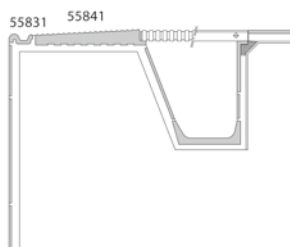

Rillenstein schräg zur Fortführung des Beckenrandsystems „Finland II“

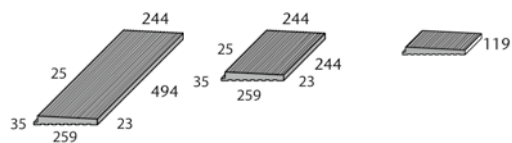

Rillenplatten 12,5 mm stark zur Fortführung des Beckenrandsystems „Finland II“

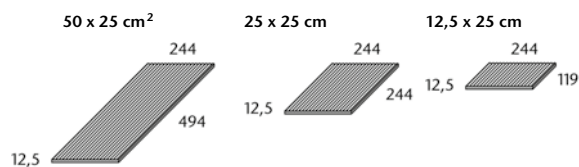

	gerillt 50 cm	gerillt 25 cm	gerillt 12,5 cm		gerillt	gerillt	gerillt
Formatnummer	55841	55840	55845		53151	53150	53159
Nennmaß - cm/in	50 x 25	25 x 25	12,5 x 25		50 x 25 / 20 x 10	25 x 25 / 10 x 10	12,5 x 25 / 5 x 10
Herstellmaß mm	494 x 244 x 23/35	244 x 244 x 23/35	119 x 244 x 23/35		494 x 244 x 12,5	244 x 244 x 12,5	119 x 244 x 12,5
m - Stück	2,000	4,000	8,000		2,000	4,000	8,000
Stück - kg	8,100	3,950	1,930		3,550	1,775	0,888
Paket - Stück	2	6	12		6	9	21
Paket - m	1,000	1,500	1,500		3,000	2,250	2,625
Paket - kg	16,200	23,700	37,306		21,300	15,975	18,648
Palette - m							
Palette - kg							
Produktnorm	Alb	Alb	Alb		Alb	Alb	Alb
Trittsicherheit	-/C	-/C	-/C		-/C	-/C	-/C
graubeige	900-55841 Preisgr. A638 (St.)	900-55840 Preisgr. A556 (St.)	900-55845 Preisgr. A506 (St.)		900-53151 Preisgr. A463 (St.)	900-53150 Preisgr. A430 (St.)	900-53159 Preisgr. A410 (St.)
neutral 10 (aktivweiß)	91-55841 Preisgr. A663 (St.)	91-55840 Preisgr. A573 (St.)	91-55845 Preisgr. A511 (St.)		91-53151 Preisgr. A528 (St.)	91-53150 Preisgr. A465 (St.)	91-53159 Preisgr. A423 (St.)
azur aktiv	553001-55841 Preisgr. A683 (St.)	553001-55840 Preisgr. A587 (St.)	553001-55845 Preisgr. A519 (St.)		553001-53151 Preisgr. A545 (St.)	553001-53150 Preisgr. A471 (St.)	553001-53159 Preisgr. A426 (St.)
azur hell	553002-55841 Preisgr. A683 (St.)	553002-55840 Preisgr. A587 (St.)	553002-55845 Preisgr. A519 (St.)		553002-53151 Preisgr. A545 (St.)	553002-53150 Preisgr. A471 (St.)	553002-53159 Preisgr. A426 (St.)
neutral 1 (tiefschwarz)	340-55841 Preisgr. A683 (St.)	340-55840 Preisgr. A587 (St.)	340-55845 Preisgr. A519 (St.)		340-53151 Preisgr. A545 (St.)	340-53150 Preisgr. A471 (St.)	340-53159 Preisgr. A426 (St.)
basaltgrau					8460-53151 ³ Preisgr. A560 (St.)	8460-53150 ³ Preisgr. A480 (St.)	8460-53159 ³ Preisgr. A430 (St.)
quarzgrau					8461-53151 ³ Preisgr. A560 (St.)	8461-53150 ³ Preisgr. A480 (St.)	8461-53159 ³ Preisgr. A430 (St.)
sandbeige					8462-53151 ³ Preisgr. A560 (St.)	8462-53150 ³ Preisgr. A480 (St.)	8462-53159 ³ Preisgr. A430 (St.)
sepiabraun					8463-53151 ³ Preisgr. A560 (St.)	8463-53150 ³ Preisgr. A480 (St.)	8463-53159 ³ Preisgr. A430 (St.)
weißgrau					8464-53151 ³ Preisgr. A560 (St.)	8464-53150 ³ Preisgr. A480 (St.)	8464-53159 ³ Preisgr. A430 (St.)



¹ Abdeckroste siehe S. 442, Rinnenschale siehe S. 433

² Kopfkante rektifiziert

³ Auftragsfertigung: Rückgabe und/oder Stornierung bestellter Ware nicht möglich.

Für die auf dieser Seite gezeigten Produkte wird kein Palettenrabatt gewährt.



Die dargestellten Produkte können auch in anderen Farben der Serie Chroma non-slip gefertigt werden. Gerne prüfen wir die Möglichkeit einer solchen Sonderproduktion im Einzelfall.

Projekt: Solebad / Standort: Werne, Deutschland / Architekt: Geising + Böker GmbH, Büro Vechta /
Serie: Chroma non-slip, Chroma / Foto: Jochen Stüber



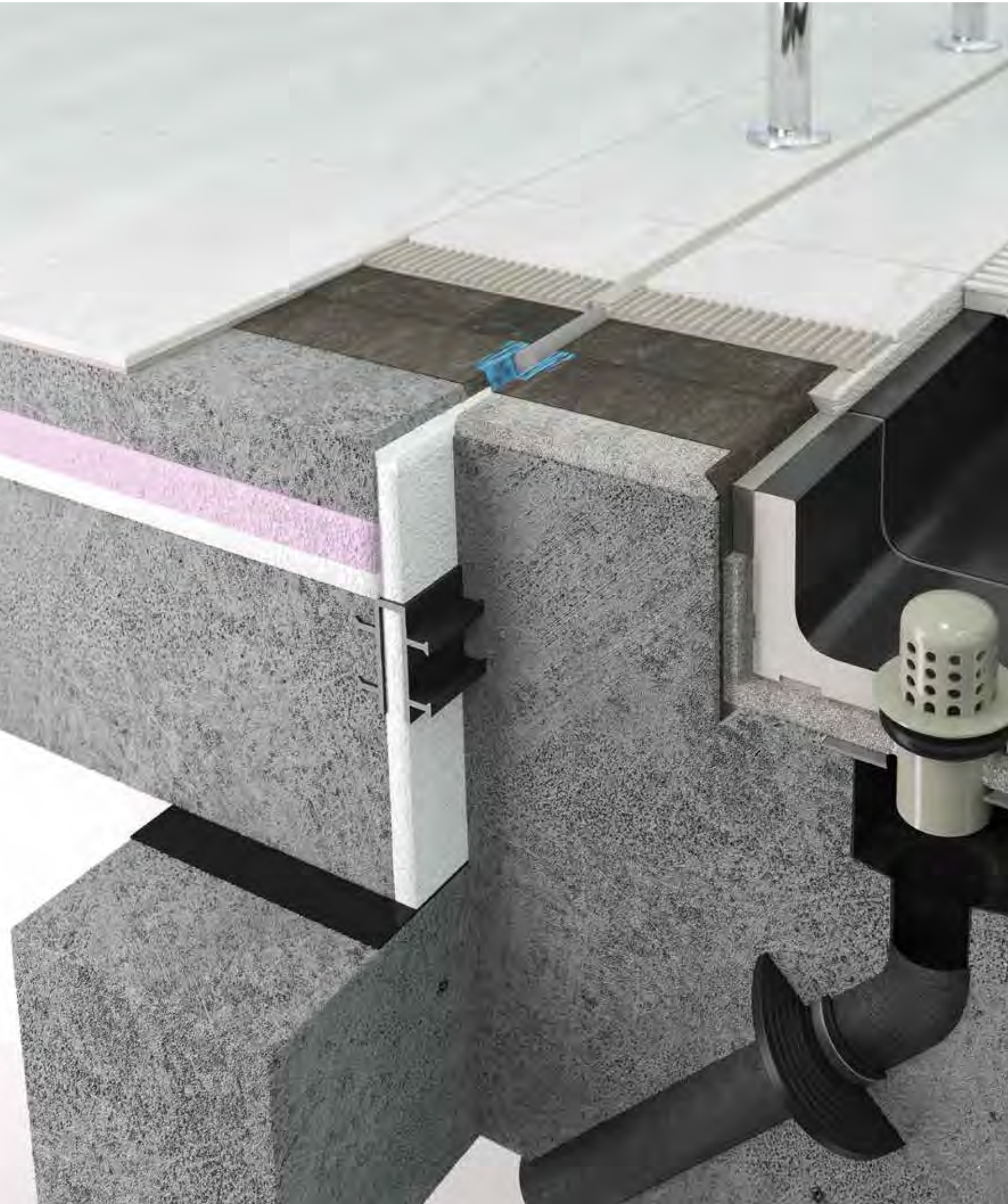



Flüsternde Spezialisten

Mit vier unterschiedlichen Ausführungen wird das System Wiesbaden auch speziellen Anforderungen, zum Beispiel bei Therapiebecken oder Strömungskanälen, gerecht. Ausgerüstet mit dem Flüsterablauf Silent W 2000, dämpft Wiesbaden hörbar den Geräuschpegel in der Schwimmhalle.

Beckenkopfsystem Wiesbaden hochliegend

Bewährt in Freizeit- und Erlebnisbädern sowie in Thermal- und Freibädern, überzeugt dieses System unter anderem durch seine rationale Bauart. Der große Rinnenstein vereint alle Anforderungen in einem einzigen Bauelement: Überlaufkante, Handfasse und Rinne. Das spart Zeit und Kosten beim Bäderbau. Wie alle Beckenkopfsysteme von Agrob Buchtal ist der Wiesbaden Rinnenstein ohne Hohlräume gefertigt und daher besonders robust.

Wiesbaden hochliegend

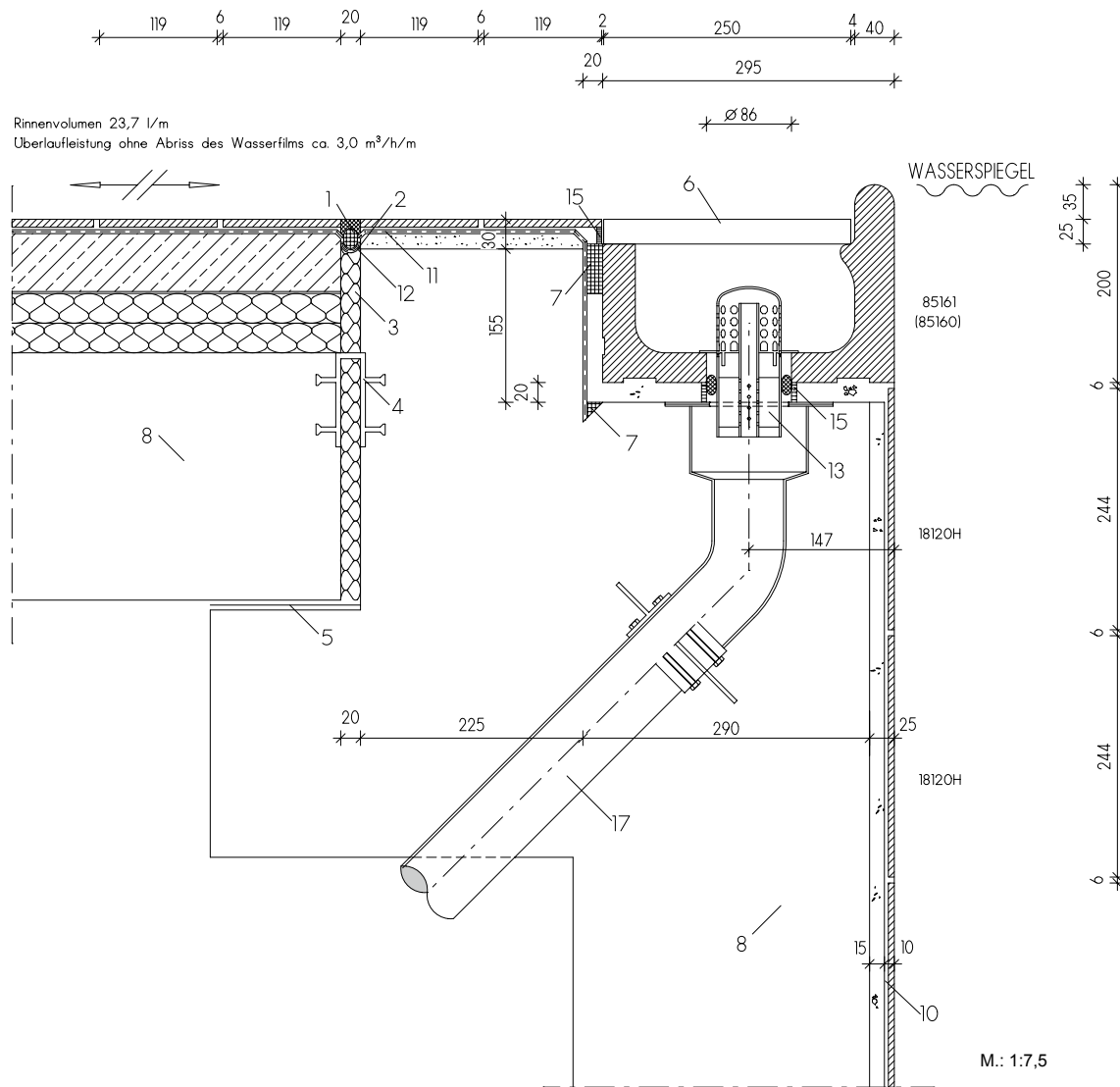

Die einzelnen Fliesen und Formteile
(= Formatnummern) dieses Systems finden
Sie unter:

- 18120H = Chroma Fliese (Seite 334 ff)
- 85160 = Überlaufrinne (Seite 373)
- 85161 = Überlaufrinne mit Ablauf (Seite 373)
- Abdeckrost (Seite 442)
- Flüsterablauf Silent W 2000 (Seite 444)

Legende:

- 01 UW-Silikon
- 02 Geschlossenzellige PE-Schaumstoffrundschnur
- 03 Wasserbeständiges elastisches Füllmaterial
- 04 Fugenband-Profil
- 05 Gleitlager
- 06 Agrob Buchtal Kunststoff-Abdeckrost
- 07 Kapillarsperre Verguss (Verwahrung)

- 08 Beton mit hohem Wassereindringwiderstand
(nach DIN EN 206/DIN
1045/DAfStB-WU-Richtlinie)
- 09 Konventionelle Dickbettverlegung
- 10 Dünnbettverlegung auf Zementputz
(P III, CS IV ohne Kalkzusatz) (DIN 18157)
- 11 Verbundabdichtung
- 12 Dichtband
- 13 Agrob Buchtal Flüsterablauf
„Silent W 2000“
- 14 Agrob Buchtal Ablaufbelüfter „Silent 100“
- 15 Objekt Fugenepxi
- 16 Agrob Buchtal Steinzeug-Rinnenschale
- 17 Einlaufkasten/Ablaufrohr und Dichtflansch

Große Rinne

(Abdeckkroste 250 mm breit, siehe S. 442)



Überlaufrinne ¹	„halbe“ Überlaufrinne	Ablauf (Ø 86 mm) ^{2/3}	Ablauf (Ø 86 mm) ²	Linke Endplatte/ Rechte Endplatte	Innenecke (Gehrungspaar 4-tlg.)	Außenecke (Gehrungspaar 4-tlg.) Eckradius 30 mm	Art. Nr. 85160
85160	85165	85161	85163	85167/85168	S85162	85166	Formatnummer
244 x 295 x 200/140	119 x 295 x 200/140	244 x 295 x 200/140	119 x 295 x 200/140	passend zum Rinnenquers.	(2x)414/119 x 295 x 200/140	(2x) 490 x 295 x 200/140	Nennmaß - cm
4,000	8,000	10,000	4,700	0,300	20,500/1 Paar	30,000/1 Paar	Herstellmaß mm
10,300/Stück	5,000/Stück	10,000/Stück	4,700/Stück	0,300/Stück	20,500/1 Paar	30,000/1 Paar	m - Stück
1 Stück	2 Stück	1 Stück	2 Stück				St./Paar - kg
0,250	0,250						Paket - St./Paar
10,300	10,000	10,000	9,400		20,500	30,000	Paket - m
							Paket - kg
							Palette - m
							Palette - kg
Alb	Alb	Alb	Alb	Alb	Alb	Alb	Produktnorm
700-85160	700-85165	700-85161	700-85163	700-85167/68	700-S85162	700-85166	neutral 10
Preisgr. A649 (St.)	Preisgr. A581 (St.)	Preisgr. A668 (St.)	Preisgr. A625 (St.)	Preisgr. A484 (St.)	Preisgr. A792 (Paar)	Preisgr. A792 (Paar)	(aktivweiß glzd.)
701-85160	701-85165	701-85161	701-85163	701-85167/68	701-S85162	701-85166	neutral 10
Preisgr. A649 (St.)	Preisgr. A581 (St.)	Preisgr. A668 (St.)	Preisgr. A625 (St.)	Preisgr. A484 (St.)	Preisgr. A792 (Paar)	Preisgr. A792 (Paar)	(aktivweiß matt)
552001-85160	552001-85165	552001-85161	552001-85163	552001-85167/68	552001-S85162	552001-85166	azur aktiv
Preisgr. A654 (St.)	Preisgr. A587 (St.)	Preisgr. A683 (St.)	Preisgr. A629 (St.)	Preisgr. A489 (St.)	Preisgr. A800 (Paar)	Preisgr. A800 (Paar)	
552002-85160	552002-85165	552002-85161	552002-85163	552002-85167/68	552002-S85162	552002-85166	azur hell
Preisgr. A654 (St.)	Preisgr. A587 (St.)	Preisgr. A683 (St.)	Preisgr. A629 (St.)	Preisgr. A489 (St.)	Preisgr. A800 (Paar)	Preisgr. A800 (Paar)	neutral 1
5716-85160⁴	5716-85165⁴	5716-85161⁴	5716-85163⁴	5716-85167/68⁴	5716-S85162⁴	5716-85166⁴	(tiefschwarz)
Preisgr. A654 (St.)	Preisgr. A587 (St.)	Preisgr. A683 (St.)	Preisgr. A629 (St.)	Preisgr. A489 (St.)	Preisgr. A800 (Paar)	Preisgr. A800 (Paar)	

¹ Für den Steigleiterbereich auch mit unterseitig gerundeter Vorderkante erhältlich.

² Passender Flüsterablauf „Silent W 2000“ auf S. 444 ff.

³ Format 85161 auch mit Ablauf Ø 100 mm erhältlich (=Format S51312)

⁴ Produktionsbedingt können Farbunterschiede zwischen Formstücken und Flächenware auftreten.



Kleine Rinne

(Abdeckkroste 191 mm breit, siehe S. 442)



Überlaufrinne	„halbe“ Überlaufrinne	Ablauf (Ø 86 mm) ²	Ablauf (Ø 86 mm) ²	Linke Endplatte/ Rechte Endplatte	Innenecke (Gehrungspaar 4-tlg.)	Außenecke (Gehrungspaar 4-tlg.) Eckradius 30 mm	Art. Nr. 55180
55180	55185	55181	S50044	55187/55188	S55182	55186	Formatnummer
244 x 225 x 150/105	119 x 225 x 150/105	244 x 225 x 150/105	119 x 225 x 150/105	passend zum Rinnenquers.	(2x)344/119 x 225 x 150/105	(2x) 240x225x150/105	Nennmaß - cm
4,000	8,000	6,600	3,100	0,200	11,800/1 Paar	8,300/1 Paar	Herstellmaß mm
7,000/Stück	3,425/Stück	6,600/Stück	3,100/Stück	0,200/Stück	11,800/1 Paar	8,300/1 Paar	m - Stück
1 Stück	2 Stück	1 Stück	2 Stück				St./Paar - kg
0,250	0,250						Paket - St./Paar
7,000	6,860	6,600	6,200		11,800	8,300	Paket - m
							Paket - kg
							Palette - m
							Palette - kg
Alb	Alb	Alb	Alb	Alb	Alb	Alb	Produktnorm
700-55180	700-55185	700-55181	700-S50044	700-55187/88	700-S55182	700-55186	neutral 10
Preisgr. A615 (St.)	Preisgr. A547 (St.)	Preisgr. A645 (St.)	Preisgr. A601 (St.)	Preisgr. A487 (St.)	Preisgr. A723 (Paar)	Preisgr. A723 (Paar)	(aktivweiß glzd.)
701-55180	701-55185	701-55181	701-S50044	701-55187/88	701-S55182	701-55186	neutral 10
Preisgr. A615 (St.)	Preisgr. A547 (St.)	Preisgr. A645 (St.)	Preisgr. A601 (St.)	Preisgr. A487 (St.)	Preisgr. A723 (Paar)	Preisgr. A723 (Paar)	(aktivweiß matt)
552001-55180	552001-55185	552001-55181	552001-S50044	552001-55187/88	552001-S55182	552001-55186	azur aktiv
Preisgr. A618 (St.)	Preisgr. A556 (St.)	Preisgr. A654 (St.)	Preisgr. A608 (St.)	Preisgr. A489 (St.)	Preisgr. A731 (Paar)	Preisgr. A731 (Paar)	
552002-55180	552002-55185	552002-55181	552002-S50044	552002-55187/88	552002-S55182	552002-55186	azur hell
Preisgr. A618 (St.)	Preisgr. A556 (St.)	Preisgr. A654 (St.)	Preisgr. A608 (St.)	Preisgr. A489 (St.)	Preisgr. A731 (Paar)	Preisgr. A731 (Paar)	neutral 1
5716-55180⁴	5716-55185⁴	5716-55181⁴	5716-S50044⁴	5716-55187/88⁴	5716-S55182⁴	5716-55186⁴	(tiefschwarz)
Preisgr. A618 (St.)	Preisgr. A556 (St.)	Preisgr. A654 (St.)	Preisgr. A608 (St.)	Preisgr. A489 (St.)	Preisgr. A731 (Paar)	Preisgr. A731 (Paar)	



Die dargestellten Produkte können auch in anderen Farben der Serie Chroma gefertigt werden. Gerne prüfen wir die Möglichkeit einer solchen Sonderproduktion im Einzelfall.

² Passender Flüsterablauf „Silent W 2000“ siehe S. 444 ff.

⁴ Produktionsbedingt können Farbunterschiede zwischen Formstücken und Flächenware auftreten.

Für die auf dieser Seite gezeigten Produkte sind auf Wunsch konische Zuschnitte möglich.
Für die auf dieser Seite gezeigten Produkte wird kein Palettenrabatt gewährt.



Wiesbaden Silent

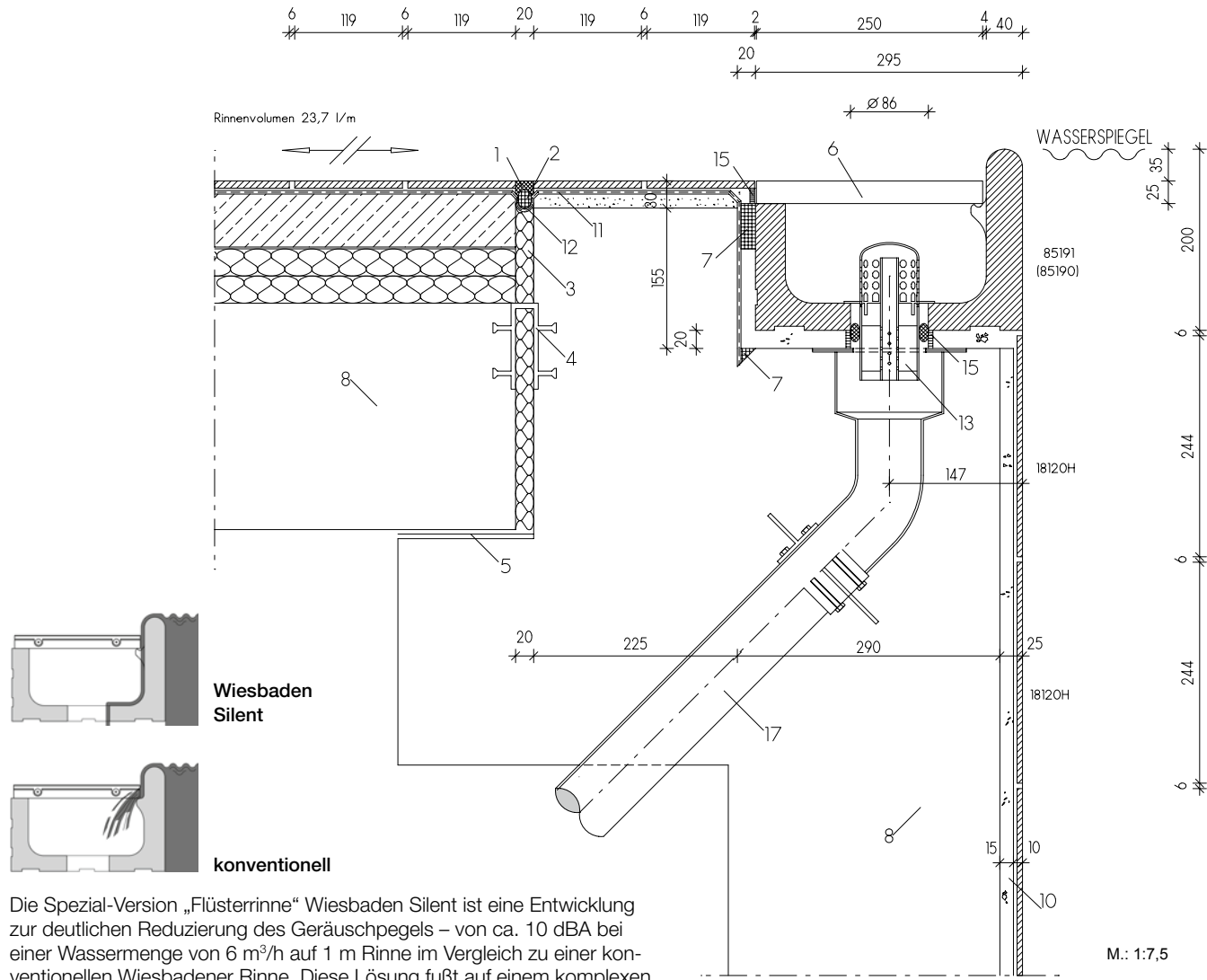

Die Spezial-Version „Flüsterrinne“ Wiesbaden Silent ist eine Entwicklung zur deutlichen Reduzierung des Geräuschpegels – von ca. 10 dBA bei einer Wassermenge von 6 m³/h auf 1 m Rinne im Vergleich zu einer konventionellen Wiesbadener Rinne. Diese Lösung fußt auf einem komplexen Zusammenspiel aus Rinnenformgebung, Abdeckrost-Platzierung und speziell gestalteter Abdeckrost-Auflage-Leiste.

Die einzelnen Fliesen und Formteile (= Formatnummern) dieses Systems finden Sie unter:

- 18120H = Chroma Fliese (Seite 334 ff)
- 85190 = Überlaufrinne (Seite 375)
- 85191 = Überlaufrinne mit Ablauf (Seite 375)
- Abdeckrost (Seite 442)
- Flüsterablauf Silent W 2000 (Seite 444)

Legende:

- 01 UW-Silikon
- 02 Geschlossenzellige PE-Schaumstoffrundschnur
- 03 Wasserbeständiges elastisches Füllmaterial
- 04 Fugenband-Profil
- 05 Gleitlager
- 06 Agrob Buchtal Kunststoff-Abdeckrost

- 07 Kapillarsperre Verguss (Verwahrung)
- 08 Beton mit hohem Wassereindringwiderstand (nach DIN EN 206/DIN 1045/DAfStB-WU-Richtlinie)
- 09 Konventionelle Dickbettverlegung
- 10 Dünnbettverlegung auf Zementputz (P III, CS IV ohne Kalkzusatz) (DIN 18157)
- 11 Verbundabdichtung
- 12 Dichtband
- 13 Agrob Buchtal Flüsterablauf „Silent W 2000“
- 14 Agrob Buchtal Ablaufbelüfter „Silent 100“
- 15 Objekt Fugenepxi
- 16 Agrob Buchtal Steinzeug-Rinnenschale
- 17 Einlaufkasten/Ablaufrohr und Dichtflansch

Große „Flüsterrinne“

(nur Querroste 250 mm breit, siehe S. 442 verwendbar)



Überlaufrinne ¹	„halbe“ Überlaufrinne	Ablauf (Ø 86 mm) ^{2/3}	Ablauf (Ø 86 mm) ²	Linke Endplatte/ Rechte Endplatte	Innenecke (Gehrungspaar 4-tlg.)	Außenecke (Gehrungspaar 4-tlg.) Eckradius 30 mm	Art. Nr. 85190
85190	85195	85191	85193	85197/85198	S85192	85196	Formatnummer
244 x 295 x 200/140 4,000	119 x 295 x 200/140 8,000	244 x 295 x 200/140	119 x 295 x 200/140	passend zum Rinnenquers.	(2x) 414/119 x 295 x 200/140	(2x) 490 x 295 x 200/140	Nennmaß - cm
10,400/Stück	5,100/Stück	10,100/Stück	4,800/Stück	0,300/Stück	20,800/Paar	30,400/Paar	Herstellmaß mm
1 Stück	2 Stück	1 Stück	2 Stück		1 Paar	1 Paar	m - Stück
0,250	0,250						St./Paar - kg
10,400	10,200	10,100	9,600		20,800	30,400	Paket - St./Paar
							Paket - m
							Paket - kg
							Palette - m
							Palette - kg
							Produktnorm
Alb	Alb	Alb	Alb	Alb	Alb	Alb	neutral 10
700-85190	700-85195	700-85191	700-85193	700-85197/98	700-S85192	700-85196	(aktivweiß glzd.)
Preisgr. A715 (St.)	Preisgr. A638 (St.)	Preisgr. A734 (St.)	Preisgr. A689 (St.)	Preisgr. A539 (St.)	Preisgr. A814 (Paar)	Preisgr. A814 (Paar)	neutral 10
701-85190	701-85195	701-85191	701-85193	701-85197/98	701-S85192	701-85196	(aktivweiß matt)
Preisgr. A715 (St.)	Preisgr. A638 (St.)	Preisgr. A734 (St.)	Preisgr. A689 (St.)	Preisgr. A539 (St.)	Preisgr. A814 (Paar)	Preisgr. A814 (Paar)	
552001-85190	552001-85195	552001-85191	552001-85193	552001-85197/98	552001-S85192	552001-85196	azur aktiv
Preisgr. A716 (St.)	Preisgr. A645 (St.)	Preisgr. A741 (St.)	Preisgr. A698 (St.)	Preisgr. A545 (St.)	Preisgr. A816 (Paar)	Preisgr. A816 (Paar)	
552002-85190	552002-85195	552002-85191	552002-85193	552002-85197/98	552002-S85192	552002-85196	azur hell
Preisgr. A716 (St.)	Preisgr. A645 (St.)	Preisgr. A741 (St.)	Preisgr. A698 (St.)	Preisgr. A545 (St.)	Preisgr. A816 (Paar)	Preisgr. A816 (Paar)	
5716-85190⁴	5716-85195⁴	5716-85191⁴	5716-85193⁴	5716-85197/98⁴	5716-S85192⁴	5716-85196⁴	neutral 1
Preisgr. A716 (St.)	Preisgr. A645 (St.)	Preisgr. A741 (St.)	Preisgr. A698 (St.)	Preisgr. A545 (St.)	Preisgr. A816 (Paar)	Preisgr. A816 (Paar)	(tiefschwarz)

¹ Für den Steigleiterbereich auch mit unterseitig gerundeter Vorderkante erhältlich.

² Passender Flüsterablauf „Silent W 2000“ siehe S. 444 ff.

³ Format 85191 auch mit Ablauf Ø 100 mm erhältlich. (= Format S51325)

⁴ Produktionsbedingt können Farbunterschiede zwischen Formstücken und Flächenware auftreten.

 Die dargestellten Produkte können auch in anderen Farben der Serie Chroma gefertigt werden. Gerne prüfen wir die Möglichkeit einer solchen Sonderproduktion im Einzelfall.



Kleine „Flüsterrinne“

(nur Querroste 191 mm breit, siehe S. 442 verwendbar)



Überlaufrinne	„halbe“ Überlaufrinne	Ablauf (Ø 86 mm) ²	Ablauf (Ø 86 mm) ²	Linke Endplatte/ Rechte Endplatte	Innenecke (Gehrungspaar 4-tlg.)	Außenecke (Gehrungspaar) Eckradius 30 mm	Art. Nr. 85180
85180	85185	85181	85183	85187/85188	S85182	85186	Formatnummer
244 x 225 x 150/105 4,000	119 x 225 x 150/105 8,000	244 x 225 x 150/105	119 x 225 x 150/105	passend zum Rinnenquers.	(2x) 344/119 x 225 x 150/105	(2x) 240 x 225 x 150/105	Nennmaß - cm
7,000/Stück	3,430/Stück	6,600/Stück	3,100/Stück	0,200/Stück	11,800/Paar	8,300/Paar	m - Stück
1 Stück	2 Stück	1 Stück	2 Stück		1 Paar	1 Paar	St./Paar - kg
0,250	0,250						Paket - St./Paar
7,000	6,860	6,600	6,200		11,800	8,300	Paket - m
							Paket - kg
							Palette - m
							Palette - kg
							Produktnorm
Alb	Alb	Alb	Alb	Alb	Alb	Alb	neutral 10
700-85180	700-85185	700-85181	700-85183	700-85187/88	700-S85182	700-85186	(aktivweiß glzd.)
Preisgr. A649 (St.)	Preisgr. A581 (St.)	Preisgr. A683 (St.)	Preisgr. A638 (St.)	Preisgr. A511 (St.)	Preisgr. A757 (Paar)	Preisgr. A757 (Paar)	neutral 10
701-85180	701-85185	701-85181	701-85183	701-85187/88	701-S85182	701-85186	(aktivweiß matt)
Preisgr. A649 (St.)	Preisgr. A581 (St.)	Preisgr. A683 (St.)	Preisgr. A638 (St.)	Preisgr. A511 (St.)	Preisgr. A757 (Paar)	Preisgr. A757 (Paar)	
552001-85180	552001-85185	552001-85181	552001-85183	552001-85187/88	552001-S85182	552001-85186	azur aktiv
Preisgr. A654 (St.)	Preisgr. A587 (St.)	Preisgr. A698 (St.)	Preisgr. A645 (St.)	Preisgr. A514 (St.)	Preisgr. A766 (Paar)	Preisgr. A766 (Paar)	
552002-85180	552002-85185	552002-85181	552002-85183	552002-85187/88	552002-S85182	552002-85186	azur hell
Preisgr. A654 (St.)	Preisgr. A587 (St.)	Preisgr. A698 (St.)	Preisgr. A645 (St.)	Preisgr. A514 (St.)	Preisgr. A766 (Paar)	Preisgr. A766 (Paar)	
5716-85180⁴	5716-85185⁴	5716-85181⁴	5716-85183⁴	5716-85187/88⁴	5716-S85182⁴	5716-85186⁴	neutral 1
Preisgr. A654 (St.)	Preisgr. A587 (St.)	Preisgr. A698 (St.)	Preisgr. A645 (St.)	Preisgr. A514 (St.)	Preisgr. A766 (Paar)	Preisgr. A766 (Paar)	(tiefschwarz)

² Passender Flüsterablauf „Silent W 2000“ siehe S. 444 ff.

⁴ Produktionsbedingt können Farbunterschiede zwischen Formstücken und Flächenware auftreten.

Für die auf dieser Seite gezeigten Produkte sind auf Wunsch konische Zuschnitte möglich.
Für die auf dieser Seite gezeigten Produkte wird kein Palettenrabatt gewährt.



3D-Rendering



Große Rinne (auf Anfrage auch als geräuscharme Flüsterrinne Wiesbaden Silent = Format 95190 erhältlich)
(Abdeckroste 250 mm breit, siehe S. 442)



Überlaufrinne	„halbe“ Überlaufrinne	Ablauf (Ø 86 mm) ¹	Ablauf (Ø 86 mm) ¹	linke Endplatte/ rechte Endplatte	Innenecke (Gehrungspaar 4-tlg.)	Außenecke (Gehrungspaar 4-tlg.) Eckradius 30 mm	Art. Nr. 95160
95160	95165	95161	95163	85167/85168	S95162	95166	Formatnummer
244 x 295 x 200/140	119 x 295 x 200/140	244 x 295 x 200/140	119 x 295 x 200/140	passend zum Rinnenquers.	(2x) 414/119 x 295 x 200/140	(2x) 490 x 295 x 200/140	Nennmaß - cm
4,000	8,000						Herstellmaß mm
9,800/Stück	4,900/Stück	9,500/Stück	4,750/Stück	0,300/Stück	20,200/Paar	29,200/Paar	m - Stück
1 Stück	2 Stück	1 Stück	2 Stück		1 Paar	1 Paar	St./Paar - kg
0,250	0,250						Paket - St./Paar
9,800	9,800	9,500	9,500		20,200	29,200	Paket - m
							Paket - kg
							Palette - m
							Palette - kg
Alb	Alb	Alb	Alb	Alb	Alb	Alb	Produktnorm
700-95160	700-95165	700-95161	700-95163	700-85167/68	700-S95162	700-95166	neutral 10
Preisgr. A663 (St.)	Preisgr. A593 (St.)	Preisgr. A683 (St.)	Preisgr. A638 (St.)	Preisgr. A484 (St.)	Preisgr. A799 (Paar)	Preisgr. A799 (Paar)	(aktivweiß glzd.)
701-95160	701-95165	701-95161	701-95163	701-85167/68	701-S95162	701-95166	neutral 10
Preisgr. A663 (St.)	Preisgr. A593 (St.)	Preisgr. A683 (St.)	Preisgr. A638 (St.)	Preisgr. A484 (St.)	Preisgr. A799 (Paar)	Preisgr. A799 (Paar)	(aktivweiß matt)
552001-95160	552001-95165	552001-95161	552001-95163	552001-85167/68	552001-S95162	552001-95166	azur aktiv
Preisgr. A668 (St.)	Preisgr. A600 (St.)	Preisgr. A698 (St.)	Preisgr. A645 (St.)	Preisgr. A489 (St.)	Preisgr. A804 (Paar)	Preisgr. A804 (Paar)	
552002-95160	552002-95165	552002-95161	552002-95163	552002-85167/68	552002-S95162	552002-95166	azur hell
Preisgr. A668 (St.)	Preisgr. A600 (St.)	Preisgr. A698 (St.)	Preisgr. A645 (St.)	Preisgr. A489 (St.)	Preisgr. A804 (Paar)	Preisgr. A804 (Paar)	
5716-95160³	5716-95165³	5716-95161³	5716-95163³	5716-85167/68³	5716-S95162³	5716-95166³	neutral 1
Preisgr. A668 (St.)	Preisgr. A600 (St.)	Preisgr. A698 (St.)	Preisgr. A645 (St.)	Preisgr. A489 (St.)	Preisgr. A804 (Paar)	Preisgr. A804 (Paar)	(tiefschwarz)

¹ Passender Flüsterablauf „Silent W 2000“ auf S. 444

² Passendes Mosaik siehe Serie Plural

³ Produktionsbedingt können Farbunterschiede zwischen Formstücken und Flächenware auftreten.

Die dargestellten Produkte können auch in anderen Farben der Serie Chroma gefertigt werden. Gerne prüfen wir die Möglichkeit einer solchen Sonderproduktion im Einzelfall.



Kleine Rinne (auf Anfrage auch als geräuscharme Flüsterrinne Wiesbaden Silent = Format 96180 erhältlich)
(Abdeckroste 191 mm breit, siehe S. 442)



Überlaufrinne	„halbe“ Überlaufrinne	Ablauf (Ø 86 mm) ¹	Ablauf (Ø 86 mm) ¹	linke Endplatte/ rechte Endplatte	Innenecke (Gehrungspaar 4-tlg.)	Außenecke (Gehrungspaar) Eckradius 30 mm	Art. Nr. 95180
95180	95185	95181	95183	55187/55188	S95182	95186	Formatnummer
244 x 225 x 150/105	119 x 225 x 150/105	244 x 225 x 150/105	119 x 225 x 150/105	passend zum Rinnenquers.	(2x) 344/119 x 225 x 150/105	(2x) 240 x 225 x 150/105	Nennmaß - cm
4,000	8,000						Herstellmaß mm
7,000/Stück	3,430/Stück	6,600/Stück	3,100/Stück	0,200/Stück	11,800/Paar	8,300/Paar	m - Stück
1 Stück	2 Stück	1 Stück	2 Stück		1 Paar	1 Paar	St./Paar - kg
0,250	0,250						Paket - St./Paar
7,000	6,860	6,600	6,200		11,800	8,300	Paket - m
							Paket - kg
							Palette - m
							Palette - kg
Alb	Alb	Alb	Alb	Alb	Alb	Alb	Produktnorm
700-95180	700-95185	700-95181	700-95183	700-55187/88	700-S95182	700-95186	neutral 10
Preisgr. A625 (St.)	Preisgr. A560 (St.)	Preisgr. A663 (St.)	Preisgr. A615 (St.)	Preisgr. A487 (St.)	Preisgr. A734 (Paar)	Preisgr. A734 (Paar)	(aktivweiß glzd.)
701-95180	701-95185	701-95181	701-95183	701-55187/88	701-S95182	701-95186	neutral 10
Preisgr. A625 (St.)	Preisgr. A560 (St.)	Preisgr. A663 (St.)	Preisgr. A615 (St.)	Preisgr. A487 (St.)	Preisgr. A734 (Paar)	Preisgr. A734 (Paar)	(aktivweiß matt)
552001-95180	552001-95185	552001-95181	552001-95183	552001-55187/88	552001-S95182	552001-95186	azur aktiv
Preisgr. A629 (St.)	Preisgr. A573 (St.)	Preisgr. A668 (St.)	Preisgr. A618 (St.)	Preisgr. A489 (St.)	Preisgr. A742 (Paar)	Preisgr. A742 (Paar)	
552002-95180	552002-95185	552002-95181	552002-95183	552002-55187/88	552002-S95182	552002-95186	azur hell
Preisgr. A629 (St.)	Preisgr. A573 (St.)	Preisgr. A668 (St.)	Preisgr. A618 (St.)	Preisgr. A489 (St.)	Preisgr. A742 (Paar)	Preisgr. A742 (Paar)	
5716-95180³	5716-95185³	5716-95181³	5716-95183³	5716-55187/88³	5716-S95182³	5716-95186³	neutral 1
Preisgr. A629 (St.)	Preisgr. A573 (St.)	Preisgr. A668 (St.)	Preisgr. A618 (St.)	Preisgr. A489 (St.)	Preisgr. A742 (Paar)	Preisgr. A742 (Paar)	(tiefschwarz)

¹ Passender Flüsterablauf „Silent W 2000“ auf S. 444

² Passendes Mosaik siehe Serie Fresh

³ Produktionsbedingt können Farbunterschiede zwischen Formstücken und Flächenware auftreten.

Für die auf dieser Seite gezeigten Produkte sind auf Wunsch konische Zuschnitte möglich.
Für die auf dieser Seite gezeigten Produkte wird kein Palettenrabatt gewährt.

Die dargestellten Produkte können auch in anderen Farben der Serie Chroma gefertigt werden. Gerne prüfen wir die Möglichkeit einer solchen Sonderproduktion im Einzelfall.



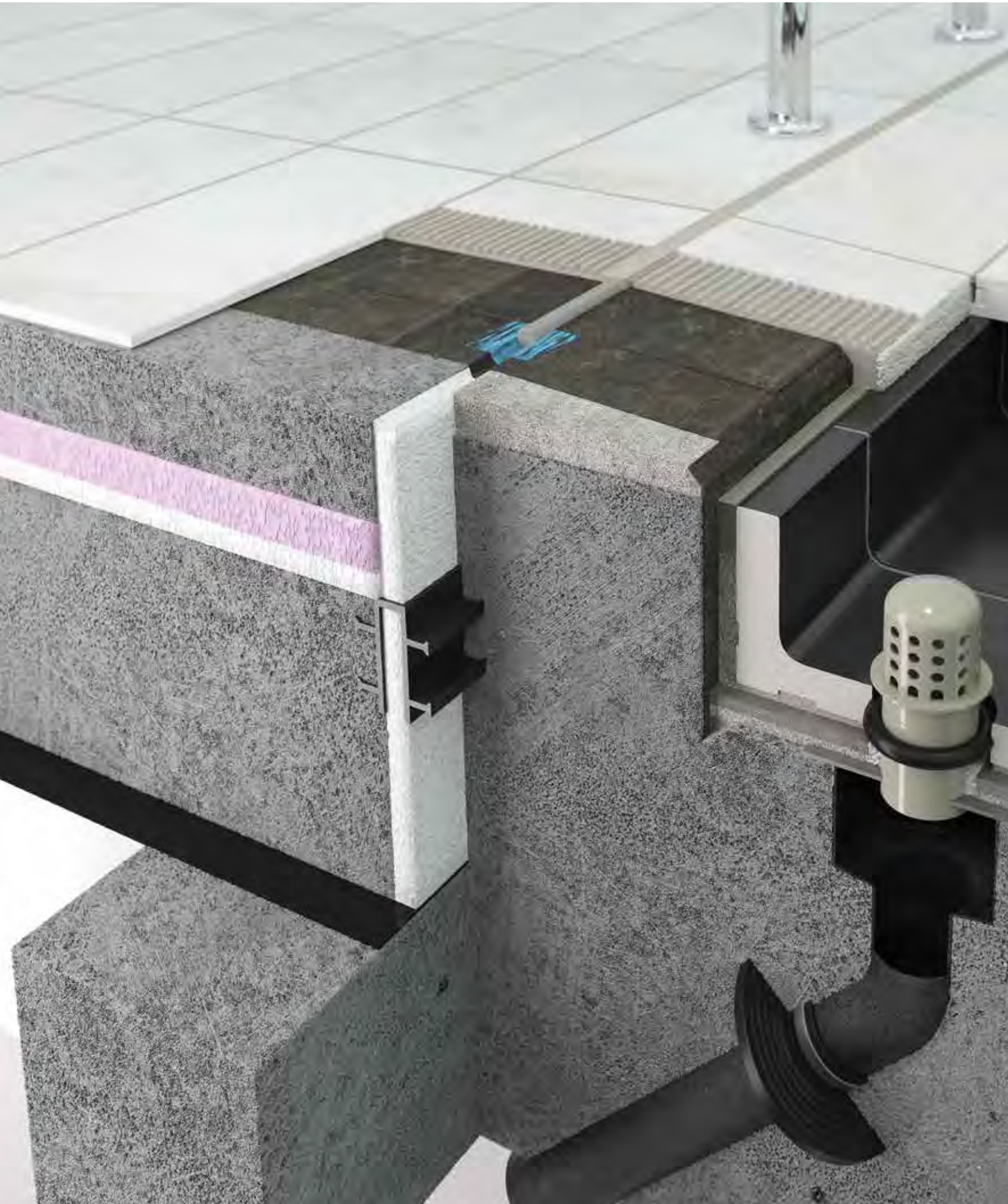



Mit klarer Kante

Das Beckenkopfsystem Wiesbaden Stil ist eine elegante Variation des Klassikers: der große Rinnenstein mit Handfasse wird mit einer keramischen Rinnenabdeckung bedeckt. Auch Wiesbaden Stil ist auf Anfrage mit Mosaikausklinkung erhältlich. Die keramische Rinnenabdeckung ermöglicht eine einheitliche Gestaltung des Beckenrandes bei Privat- und kleineren Hotelbädern. Die Abdeckung lässt sich dank Steckverbindungen einfach verlegen. Die keramische Rinnenabdeckung ist trittsicher, hoch belastbar sowie auf Wunsch und nach Prüfung in unterschiedlichen Formaten und zum Teil auch für Freiformen lieferbar. Wasserdurchsatz: freier Querschnitt 245 cm²/m beim Standard-Lochmuster.

Wiesbaden Stil

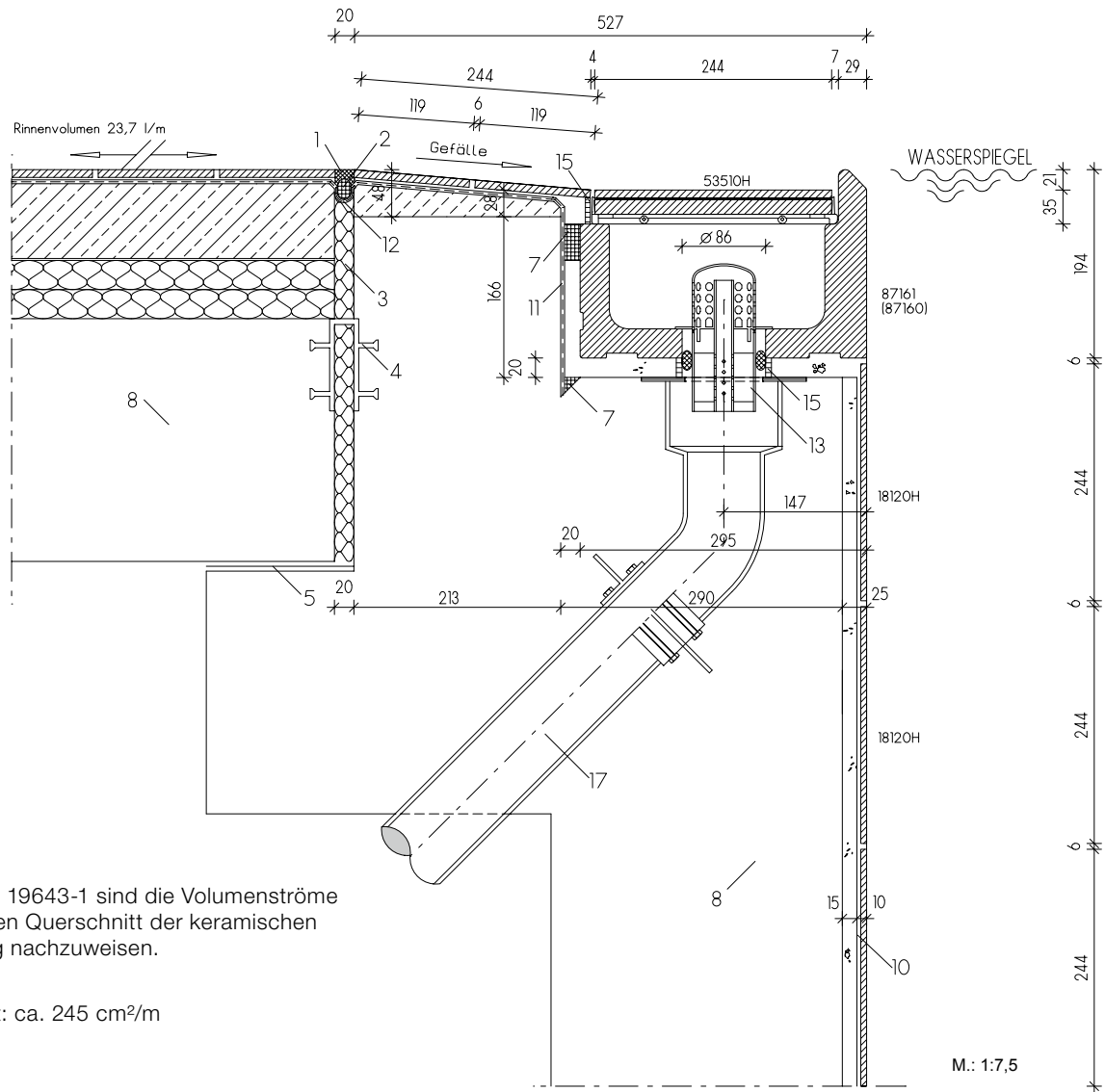

Hinweis: Laut DIN 19643-1 sind die Volumenströme in Bezug zum freien Querschnitt der keramischen Rinnenabdeckung nachzuweisen.

Freier Querschnitt: ca. 245 cm²/m

Die einzelnen Fliesen und Formteile (= Formatnummern) dieses Systems finden Sie unter:

- 18120H = Chroma Fliese (Seite 334 ff)
- 87160 = Überlaufrinne (Seite 381)
- 87161 = Überlaufrinne mit Ablauf (Seite 381)
- 53510H = Keramische Rinnenabdeckung (Seite 441)
- Flüsterablauf Silent W 2000 (Seite 444)

Legende:

- 01 UW-Silikon
- 02 Geschlossenzellige PE-Schaumstoffrundschnur
- 03 Wasserbeständiges elastisches Füllmaterial
- 04 Fugenband-Profil
- 05 Gleitlager
- 06 Agrob Buchtal Kunststoff-Abdeckrost
- 07 Kapillarsperre Verguss (Verwahrung)

- 08 Beton mit hohem Wassereindringwiderstand (nach DIN EN 206/DIN 1045/DAfStB-WU-Richtlinie)
- 09 Konventionelle Dickbettverlegung
- 10 Dünnbettverlegung auf Zementputz (P III, CS IV ohne Kalkzusatz) (DIN 18157)
- 11 Verbundabdichtung
- 12 Dichtband
- 13 Agrob Buchtal Flüsterablauf „Silent W 2000“
- 14 Agrob Buchtal Ablaufbelüfter „Silent 100“
- 15 Objekt Fugenepoxi
- 16 Agrob Buchtal Steinzeug-Rinnenschale
- 17 Einlaufkasten/Ablaufrohr und Dichtflansch

Große Rinne (auf Anfrage auch mit Mosaikausklinkung = Format 97160 erhältlich³)
(keramische Rinnenabdeckung 250 mm breit)

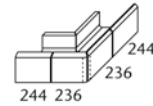
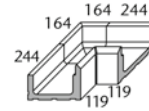
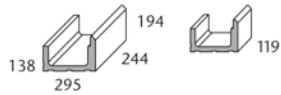

Außenecke
(Gehrungspaar 4-tlg.)
Eckradius 30 mm



Art. Nr. 87160

Überlaufrinne ¹	„halbe“ Überlaufrinne	Ablauf (Ø 86 mm) ²	Ablauf (Ø 86 mm) ²	linke Endplatte/ rechte Endplatte	Innenecke (Gehrungspaar 4-tlg.)	Außenecke (Gehrungspaar 4-tlg.) Eckradius 30 mm	Art. Nr. 87160
87160	87165	87161	87163	87167/87168	S87162	87166	Formatnummer
244 x 295 x 138/194	119 x 295 x 138/194	244 x 295 x 138/194	119 x 295 x 138/194	passend zum Rinnenquers.	(2x) 414/119 x 295 x 138/194	(2x) 486 x 295 x 138/194	Nennmaß - cm
4,000	8,000	10,000/Stück	4,700/Stück	0,300/Stück	20,500/Paar	30,000/Paar	Herstellmaß mm
10,200/Stück	5,100/Stück	10,000/Stück	4,700/Stück	0,300/Stück	20,500/Paar	30,000/Paar	m - Stück
1 Stück	2 Stück	1 Stück	2 Stück		1 Paar	1 Paar	St./Paar - kg
0,250	0,250						Paket - St./Paar
10,200	10,200	10,000	9,400		20,500	30,000	Paket - m
							Paket - kg
							Palette - m
							Palette - kg
Alb	Alb	Alb	Alb	Alb	Alb	Alb	Produktnorm
700-87160	700-87165	700-87161	700-87163	700-87167/68	700-S87162	700-87166	neutral 10
Preisgr. A649 (St.)	Preisgr. A581 (St.)	Preisgr. A668 (St.)	Preisgr. A625 (St.)	Preisgr. A484 (St.)	Preisgr. A792 (Paar)	Preisgr. A792 (Paar)	(aktivweiß glzd.)
701-87160	701-87165	701-87161	701-87163	701-87167/68	701-S87162	701-87166	neutral 10
Preisgr. A649 (St.)	Preisgr. A581 (St.)	Preisgr. A668 (St.)	Preisgr. A625 (St.)	Preisgr. A484 (St.)	Preisgr. A792 (Paar)	Preisgr. A792 (Paar)	(aktivweiß matt)
552001-87160	552001-87165	552001-87161	552001-87163	552001-87167/68	552001-S87162	552001-87166	azur aktiv
Preisgr. A654 (St.)	Preisgr. A587 (St.)	Preisgr. A683 (St.)	Preisgr. A629 (St.)	Preisgr. A489 (St.)	Preisgr. A800 (Paar)	Preisgr. A800 (Paar)	
552002-87160	552002-87165	552002-87161	552002-87163	552002-87167/68	552002-S87162	552002-87166	azur hell
Preisgr. A654 (St.)	Preisgr. A587 (St.)	Preisgr. A683 (St.)	Preisgr. A629 (St.)	Preisgr. A489 (St.)	Preisgr. A800 (Paar)	Preisgr. A800 (Paar)	
5716-87160⁴	5716-87165⁴	5716-87161⁴	5716-87163⁴	5716-87167/68⁴	5716-S87162⁴	5716-87166⁴	neutral 1
Preisgr. A654 (St.)	Preisgr. A587 (St.)	Preisgr. A683 (St.)	Preisgr. A629 (St.)	Preisgr. A489 (St.)	Preisgr. A800 (Paar)	Preisgr. A800 (Paar)	(tiefschwarz)

¹ Für den Steigleiterbereich auch mit unterseitig gerundeter Vorderkante erhältlich.

² Passender Flüsterablauf „Silent W 2000“ auf S. 444

³ Passendes Mosaik siehe Serie Plural auf S. 245 ff

⁴ Produktionsbedingt können Farbunterschiede zwischen Formstücken und Flächenware auftreten.

Für die auf dieser Seite gezeigten Produkte sind auf Wunsch konische Zuschnitte möglich.
Für die auf dieser Seite gezeigten Produkte wird kein Palettenrabatt gewährt.

 Die dargestellten Produkte können auch in anderen Farben der Serie Chroma gefertigt werden. Gerne prüfen wir die Möglichkeit einer solchen Sonderproduktion im Einzelfall.



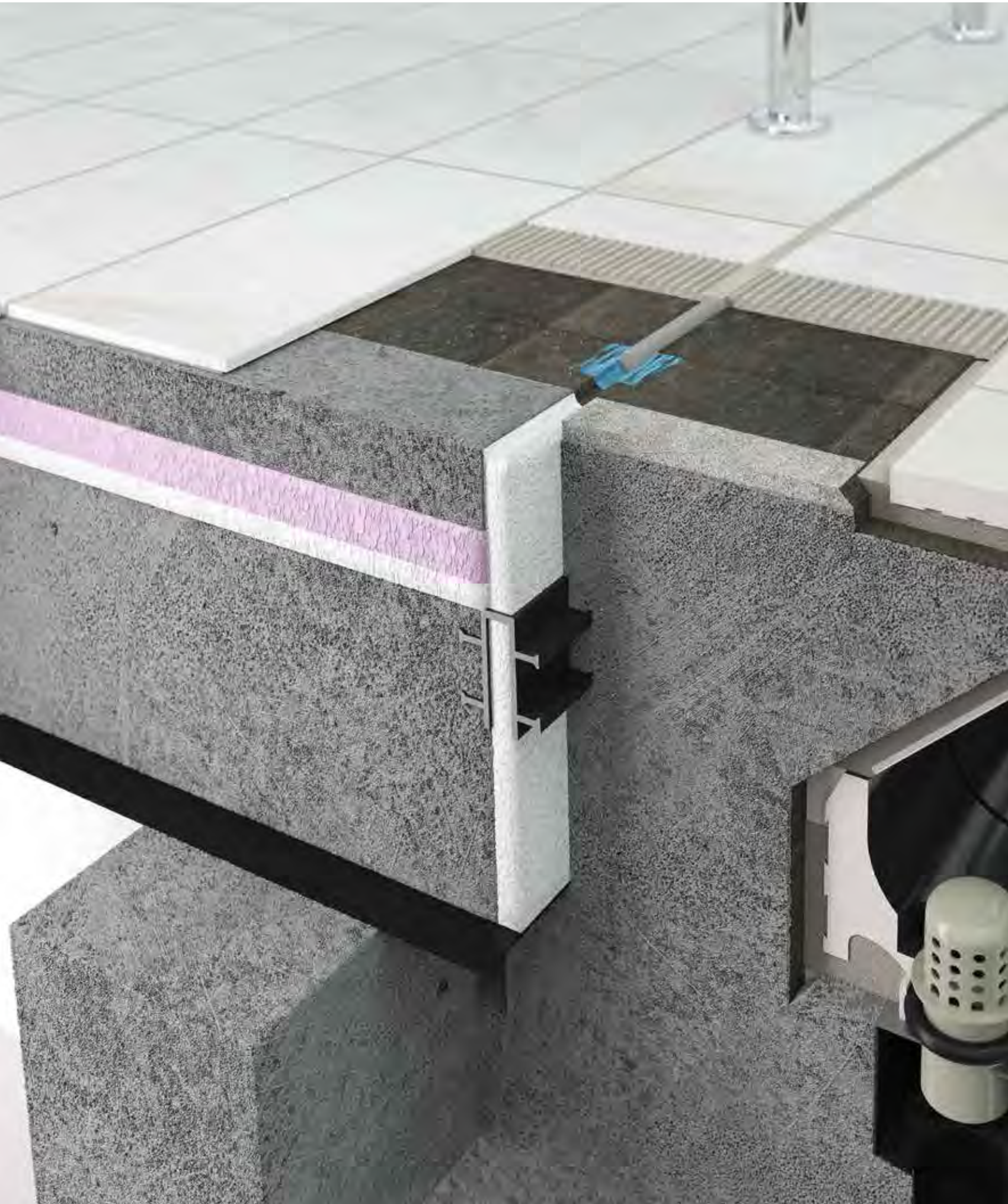



Spezialist für Attraktionen

Die tiefliegende Ausführung erlaubt eine zusätzliche „Anstauhöhe“, die vor allem für die Nutzung von Wasserattraktionen gewünscht wird. Damit eignet sich dieses System zum Beispiel optimal für Rutschenlandebecken.

Unterschiedliche Rinnenquerschnitte und Abmessungen erweitern die Einsatzmöglichkeiten, unter anderem bei erhöhten Beckenwänden in Strömungskanälen. Als Zubehör ist unter anderem der Flüsterablauf Silent W 2000 lieferbar.

Wiesbaden tiefliegend

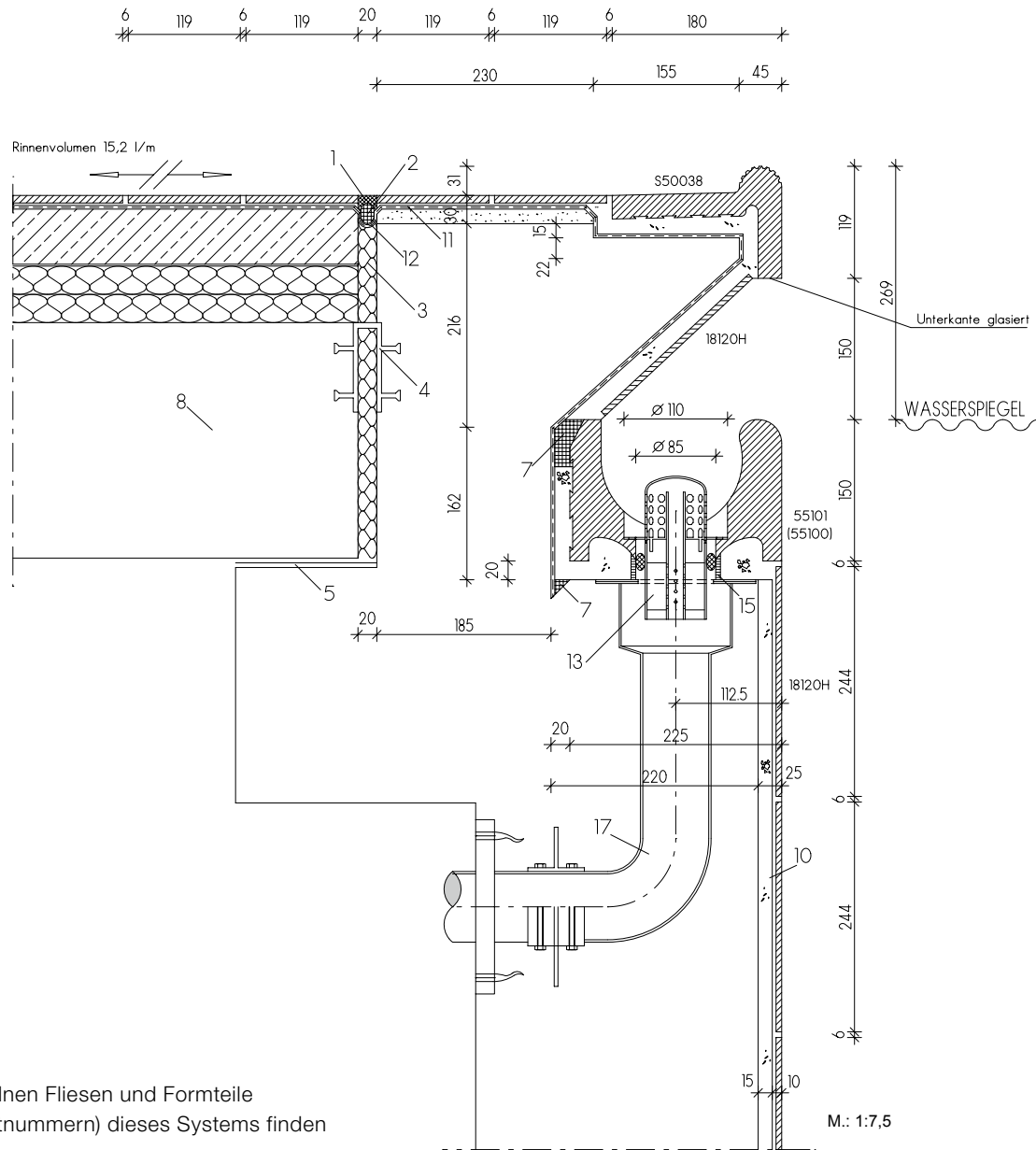

Die einzelnen Fliesen und Formteile
(= Formatnummern) dieses Systems finden
Sie unter:

- 18120H = Chroma Fliese (Seite 334 ff)
- 55100 = Überlaufrinne (Seite 385)
- 55101 = Überlaufrinne mit Ablauf (Seite 385)
- S50038 = Beckenrandstein (wie 55450 mit
glasierter Unterkante, Seite 412)
- Flüsterablauf Silent W 2000 (Seite 444)

Legende:

- 01 UW-Silikon
- 02 Geschlossenzellige PE-Schaumstoffrundschnur
- 03 Wasserbeständiges elastisches Füllmaterial
- 04 Fugenband-Profil
- 05 Gleitlager
- 06 Agrob Buchtal Kunststoff-Abdeckrost
- 07 Kapillarsperre Verguss (Verwahrung)

- 08 Beton mit hohem Wassereindringwiderstand
(nach DIN EN 206/DIN
1045/DAfStB-WU-Richtlinie)
- 09 Konventionelle Dickbettverlegung
- 10 Dünnbettverlegung auf Zementputz
(P III, CS IV ohne Kalkzusatz) (DIN 18157)
- 11 Verbundabdichtung
- 12 Dichtband
- 13 Agrob Buchtal Flüsterablauf
„Silent W 2000“
- 14 Agrob Buchtal Ablaufbelüfter „Silent 100“
- 15 Objekt Fugenepxi
- 16 Agrob Buchtal Steinzeug-Rinnenschale
- 17 Einlaufkasten/Ablaufrohr und Dichtflansch

Große Rinne (auf Anfrage auch mit Mosaikauskantung = Format 95100 erhältlich)
(ohne Abdeckrost-Auflager)



Überlaufrinne	„halbe“ Überlaufrinne	Ablauf (Ø 86 mm) ¹	Ablauf (Ø 86 mm) ¹	Linke Endplatte/ Rechte Endplatte	Innenecke (Gehrungspaar 4-tlg.)	Außenecke (Gehrungspaar) Eckradius 30 mm	Art. Nr. 55100
55100	55105	55101	550065	55107/55108	S55102	55106	Formatnummer
244 x 225 x 150	119 x 225 x 150	244 x 225 x 150	119 x 225 x 150	passend zum Rinnenquers.	(2x)344/119 x 225 x 150	(2x) 240 x 225 x 150	Nennmaß - cm
4,000	8,000						Herstellmaß mm
8,600/Stück	4,200/Stück	8,100/Stück	3,800/Stück	0,200/Stück	17,000/Paar	9,600/Paar	m - Stück
1 Stück	2 Stück	1 Stück	2 Stück		1 Paar	1 Paar	St./Paar - kg
0,250	0,250						Paket - St./Paar
8,600	8,400	8,100	7,600		16,000	9,600	Paket - m
							Paket - kg
							Palette - m
							Palette - kg
Alb	Alb	Alb	Alb	Alb	Alb	Alb	Produktnorm
700-55100	700-55105	700-55101	700-550065	700-55107/08	700-555102	700-55106	neutral 10
Preisgr. A601 (St.)	Preisgr. A545 (St.)	Preisgr. A654 (St.)	Preisgr. A638 (St.)	Preisgr. A489 (St.)	Preisgr. A716 (Paar)	Preisgr. A716 (Paar)	(aktivweiß glzd.)
701-55100	701-55105	701-55101	701-550065	701-55107/08	701-555102	701-55106	neutral 10
Preisgr. A601 (St.)	Preisgr. A545 (St.)	Preisgr. A654 (St.)	Preisgr. A638 (St.)	Preisgr. A489 (St.)	Preisgr. A716 (Paar)	Preisgr. A716 (Paar)	(aktivweiß matt)
552001-55100	552001-55105	552001-55101	552001-550065	552001-55107/08	552001-S55102	552001-55106	azur aktiv
Preisgr. A608 (St.)	Preisgr. A547 (St.)	Preisgr. A663 (St.)	Preisgr. A645 (St.)	Preisgr. A506 (St.)	Preisgr. A723 (Paar)	Preisgr. A723 (Paar)	
552002-55100	552002-55105	552002-55101	552002-550065	552002-55107/08	552002-S55102	552002-55106	azur hell
Preisgr. A608 (St.)	Preisgr. A547 (St.)	Preisgr. A663 (St.)	Preisgr. A645 (St.)	Preisgr. A506 (St.)	Preisgr. A723 (Paar)	Preisgr. A723 (Paar)	
5716-55100²	5716-55105²	5716-55101²	5716-550065²	5716-55107/08²	5716-555102²	5716-55106²	neutral 1
Preisgr. A608 (St.)	Preisgr. A547 (St.)	Preisgr. A663 (St.)	Preisgr. A645 (St.)	Preisgr. A506 (St.)	Preisgr. A723 (Paar)	Preisgr. A723 (Paar)	(tiefschwarz)

¹ Passender Flüsterablauf „Silent W 2000“ auf S. 444

² Produktionsbedingt können Farbunterschiede zwischen Formstücken und Flächenware auftreten.



Kleine Rinne
(ohne Abdeckrost-Auflager)



Überlaufrinne	„halbe“ Überlaufrinne	Ablauf (Ø 75 mm) ¹	Ablauf (Ø 75 mm) ¹	Linke Endplatte/ Rechte Endplatte	Innenecke (Gehrungspaar 4-tlg.)	Außenecke (Gehrungspaar) Eckradius 30 mm	Art. Nr. 55140
55140	55145	55141	55143	55147/55148	S55142	55146	Formatnummer
244 x 150/160 x 100/130	119 x 150/160 x 100/130	244 x 150/160 x 100/130	119 x 150/160 x 100/130	passend zum Rinnenquers.	(2x)279/119x150/160x100/130	(2x) 240x150/160x100/130	Nennmaß - cm
4,000	8,000						Herstellmaß mm
4,450/Stück	2,260/Stück	4,100/Stück	2,000/Stück	0,100/Stück	7,050/Paar	6,300/Paar	m - Stück
2 Stück	4 Stück	2 Stück	4 Stück		1 Paar	1 Paar	St./Paar - kg
0,500	0,500						Paket - St./Paar
8,900	9,040	8,200	8,000		7,050	6,300	Paket - m
							Paket - kg
							Palette - m
							Palette - kg
Alb	Alb	Alb	Alb	Alb	Alb	Alb	Produktnorm
700-55140	700-55145	700-55141	700-55143	700-55147/48	700-555142	700-55146	neutral 10
Preisgr. A600 (St.)	Preisgr. A533 (St.)	Preisgr. A636 (St.)	Preisgr. A593 (St.)	Preisgr. A487 (St.)	Preisgr. A716 (Paar)	Preisgr. A716 (Paar)	(aktivweiß glzd.)
701-55140	701-55145	701-55141	701-55143	701-55147/48	701-555142	701-55146	neutral 10
Preisgr. A600 (St.)	Preisgr. A533 (St.)	Preisgr. A636 (St.)	Preisgr. A593 (St.)	Preisgr. A487 (St.)	Preisgr. A716 (Paar)	Preisgr. A716 (Paar)	(aktivweiß matt)
552001-55140	552001-55145	552001-55141	552001-55143	552001-55147/48	552001-S55142	552001-55146	azur aktiv
Preisgr. A604 (St.)	Preisgr. A539 (St.)	Preisgr. A638 (St.)	Preisgr. A601 (St.)	Preisgr. A489 (St.)	Preisgr. A723 (Paar)	Preisgr. A723 (Paar)	
552002-55140	552002-55145	552002-55141	552002-55143	552002-55147/48	552002-S55142	552002-55146	azur hell
Preisgr. A604 (St.)	Preisgr. A539 (St.)	Preisgr. A638 (St.)	Preisgr. A601 (St.)	Preisgr. A489 (St.)	Preisgr. A723 (Paar)	Preisgr. A723 (Paar)	
5716-55140²	5716-55145²	5716-55141²	5716-55143²	5716-55147/48²	5716-555142²	5716-55146²	neutral 1
Preisgr. A604 (St.)	Preisgr. A539 (St.)	Preisgr. A638 (St.)	Preisgr. A601 (St.)	Preisgr. A489 (St.)	Preisgr. A723 (Paar)	Preisgr. A723 (Paar)	(tiefschwarz)

¹ Passender Flüsterablauf „Silent W 2000“ auf S. 444

² Produktionsbedingt können Farbunterschiede zwischen Formstücken und Flächenware auftreten.



Für die auf dieser Seite gezeigten Produkte sind auf Wunsch konische Zuschnitte möglich.
Für die auf dieser Seite gezeigten Produkte wird kein Palettenrabatt gewährt.



Die dargestellten Produkte können auch in anderen Farben der Serie Chroma gefertigt werden. Gerne prüfen wir die Möglichkeit einer solchen Sonderproduktion im Einzelfall.





In der Ausführung mit kleinem Rinnenstein ohne Abdeckung ist Wiesbaden tiefliegend vor allem für den Einsatz in Therapieeinrichtungen konzipiert. In Verbindung mit einem erhöhten Beckenrand ergibt sich ein rückenschonender Effekt für das Personal, das mit den Patienten arbeiten kann ohne ständig eine gebückte Haltung einnehmen zu müssen.

Projekt: Therapiebecken DRK-Krankenhaus / Standort: Langen-Debstedt, Deutschland / Architekt: Westphal u. Partner Architekten /
Serie: Beckenkopfsystem Wiesbaden / Foto: Veit S. Müller



Wiesbaden Therapiebecken

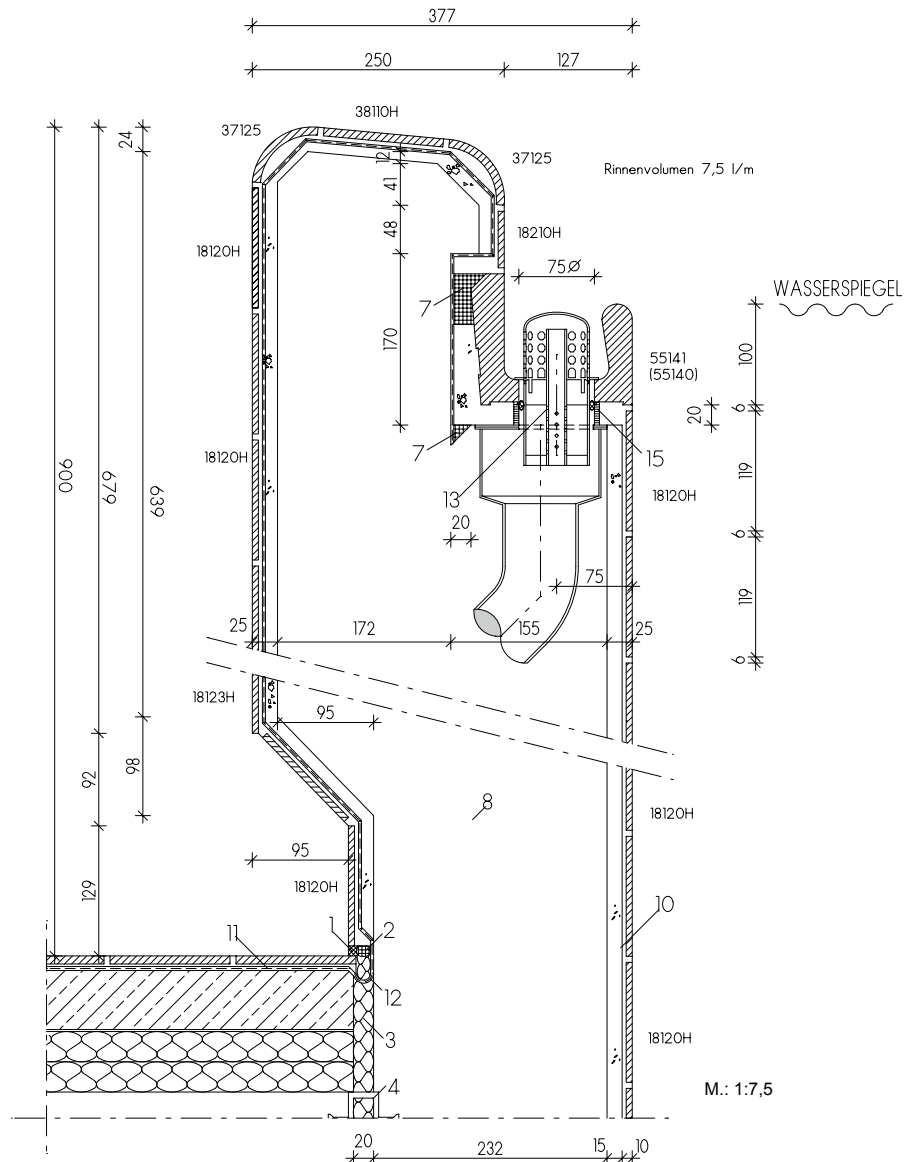

Die einzelnen Fliesen und Formteile
(= Formatnummern) dieses Systems finden
Sie unter:

- 18120H = Chroma Fliese (Seite 334 ff)
- 55140 = Überlaufrinne (Seite 385)
- 55141 = Überlaufrinne mit Ablauf (Seite 385)
- 18210H = Chroma Riemchen (Seite 334 ff)
- 37125 = Radialleiste (Seite 420)
- 38110H = Chroma non-slip Fliese (Seite 339 ff)
- 18123H = Chroma Fliese (Seite 337)
- Flüsterablauf Silent W 2000 (Seite 444)

Legende:

- 01 UW-Silikon
- 02 Geschlossenzellige PE-Schaumstoffrundschnur
- 03 Wasserbeständiges elastisches Füllmaterial
- 04 Fugenband-Profil
- 05 Gleitlager
- 06 Agrob Buchtal Kunststoff-Abdeckrost
- 07 Kapillarsperre Verguss (Verwahrung)

- 08 Beton mit hohem Wassereindringwiderstand
(nach DIN EN 206/DIN 1045/DAfStB-WU-Richtlinie)
- 09 Konventionelle Dickbettverlegung
- 10 Dünnbettverlegung auf Zementputz
(P III, CS IV ohne Kalkzusatz) (DIN 18157)
- 11 Verbundabdichtung
- 12 Dichtband
- 13 Agrob Buchtal Flüsterablauf
„Silent W 2000“
- 14 Agrob Buchtal Ablaufbelüfter „Silent 100“
- 15 Objekt Fugenepxi
- 16 Agrob Buchtal Steinzeug-Rinnenschale
- 17 Einlaufkasten/Ablaufrohr und Dichtflansch

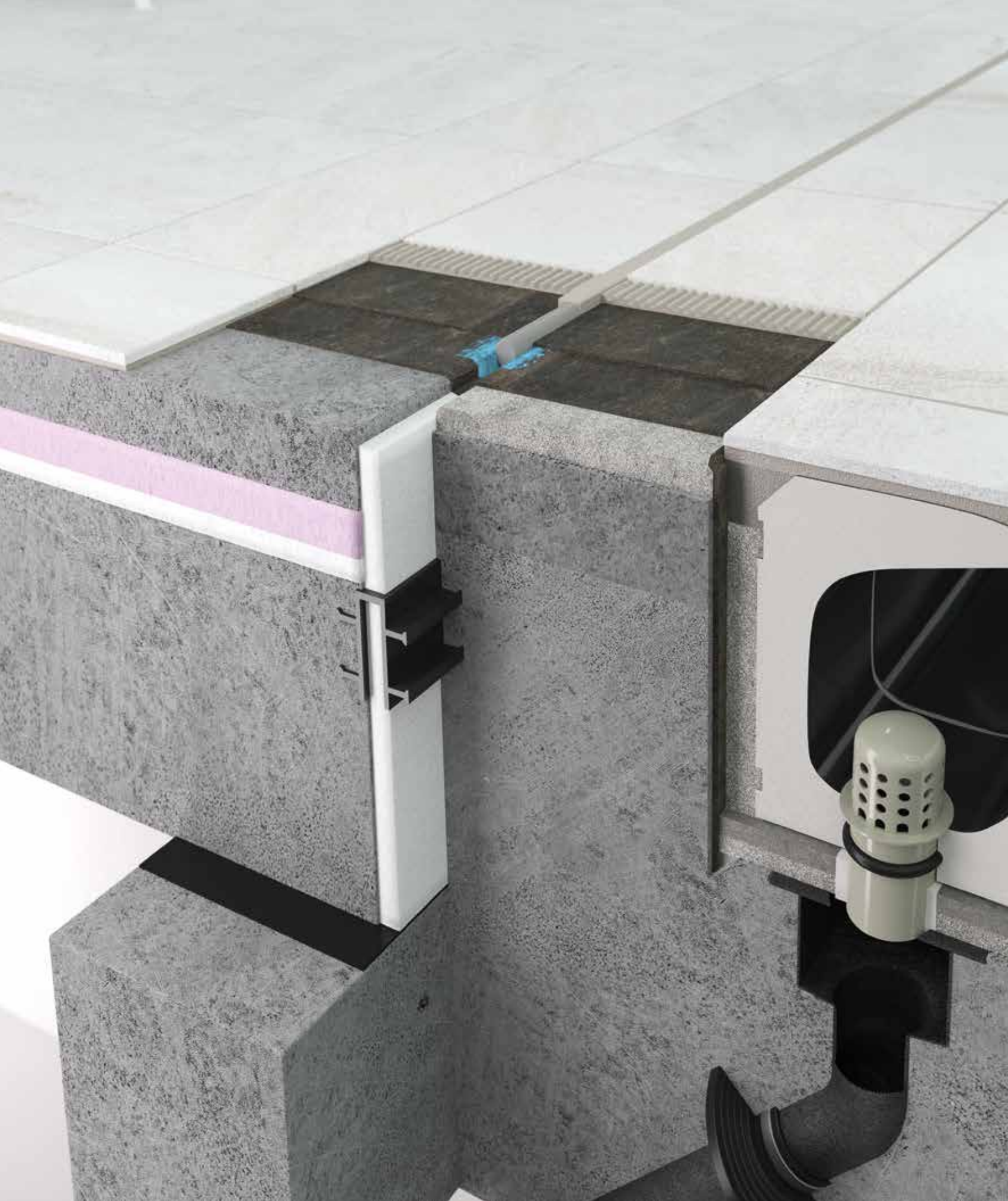



Nachhaltige Innovation

Entwickelt für Deutschlands erstes Schwimmbad nach Passivhaus Standard, überzeugt das Beckenkopfsystem Bamberg vor allem durch reduzierte Wasserverdunstung und Einsparungen beim Energieeinsatz. Zusätzliche Pluspunkte: elegante Optik ohne Abdeckroste und niedriger Geräuschpegel.

Das vielseitig einsetzbare System zeigt seine Qualitäten in Freizeit- und Erlebnisbädern genauso wie in Thermal-, Privat- und Hotelbädern. Der große Rinnenstein mit integrierter Handfasse macht Abdeckroste überflüssig, schließt unmittelbar an den Beckenumgang an und schafft so ein einheitliches Gesamtbild. Das Profil des Rinnensteins wurde in aufwändigen, wissenschaftlich begleiteten Versuchen entwickelt.

Bamberg

Während das Spritzwasser bei herkömmlichen Systemen die Verdunstungsrate erhöht, sorgt die Bamberger Rinne dank ihrer ausgeklügelten Formgebung für eine deutliche Reduktion und leistet damit einen wichtigen Beitrag zur Energieeinsparung: Wärmeverluste werden reduziert, die Lüftungsanlagen müssen weniger Luft umwälzen und verbrauchen weniger Strom. Erweiterte Möglichkeiten der individuellen Gestaltung bietet Bamberg durch unterschiedliche Farben bei Handfasse und Rinne, wobei nach Prüfung auch Sonderfarben möglich sind.

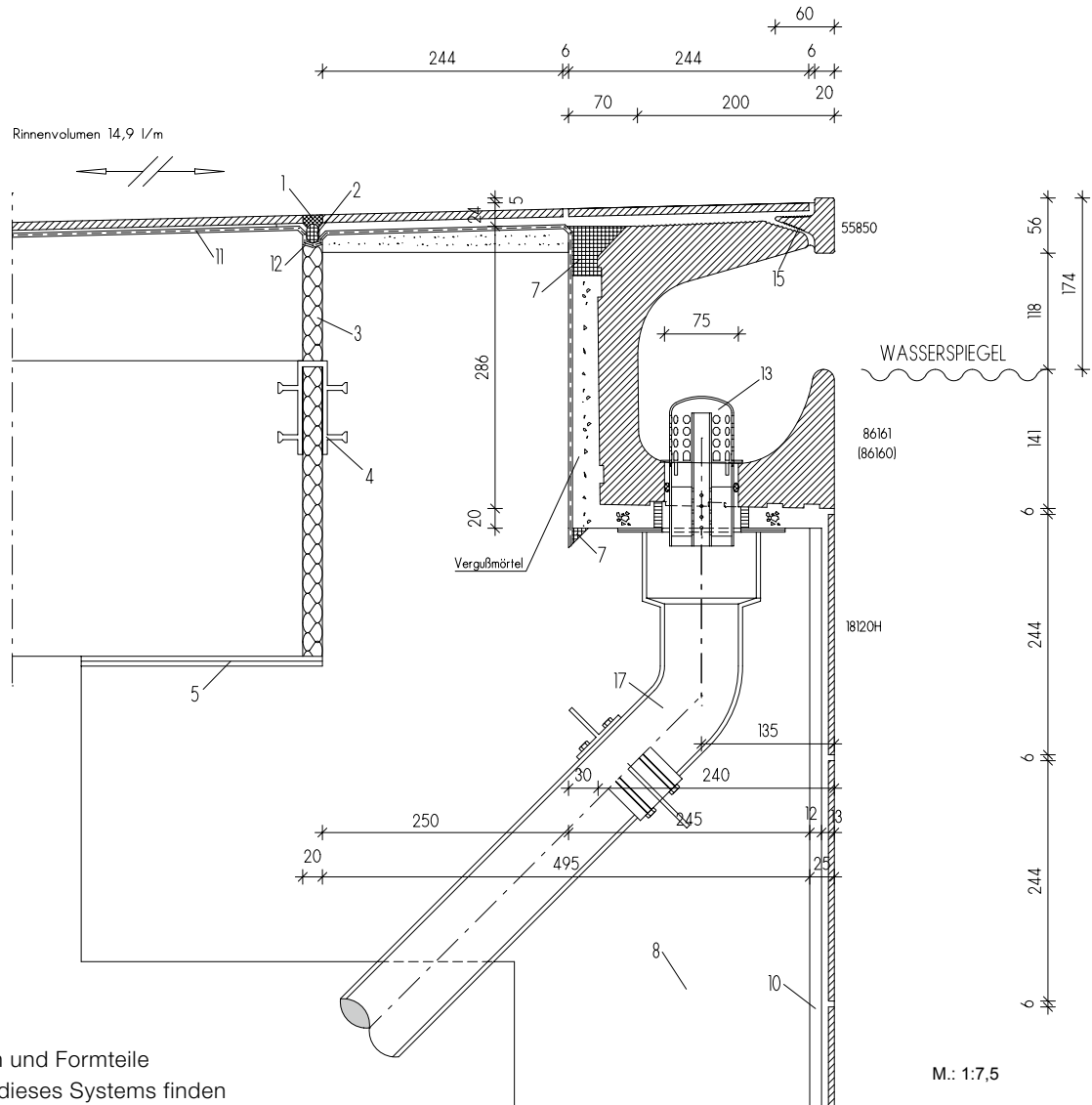

Die einzelnen Fliesen und Formteile
(= Formatnummern) dieses Systems finden
Sie unter:

- 18120H = Chroma Fliese (Seite 334 ff)
- 86160 = Überlaufrinne (Seite 393)
- 86161 = Überlaufrinne mit Ablauf (Ø 75 mm) (Seite 393)
- 55850 = Beckenrandstein (Seite 393)
- 55857/ = Anfangsstück links/rechts (Seite 393)
- 55858
- Flüsterablauf Silent W 2000 (Seite 444)

Legende:

- 01 UW-Silikon
- 02 Geschlossenzellige PE-Schaumstoffrundschnur
- 03 Wasserbeständiges elastisches Füllmaterial
- 04 Fugenband-Profil
- 05 Gleitlager
- 06 Agrob Buchtal Kunststoff-Abdeckrost
- 07 Kapillarsperre Verguss (Verwahrung)

- 08 Beton mit hohem Wassereindringwiderstand
(nach DIN EN 206/DIN
1045/DafStB-WU-Richtlinie)
- 09 Konventionelle Dickbettverlegung
- 10 Dünnbettverlegung auf Zementputz
(P III, CS IV ohne Kalkzusatz) (DIN 18157)
- 11 Verbundabdichtung
- 12 Dichtband
- 13 Agrob Buchtal Flüsterablauf
„Silent W 2000“
- 14 Agrob Buchtal Ablaufbelüfter „Silent 100“
- 15 Objekt Fugenepoxi
- 16 Agrob Buchtal Steinzeug-Rinnenschale
- 17 Einlaufkasten/Ablaufrohr und Dichtflansch

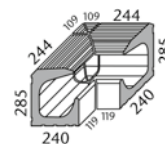
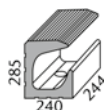

Überlaufrinne	„halbe“ Überlaufrinne	Ablauf (Ø 75 mm) ¹	Ablauf (Ø 75 mm) ¹	Linke Endplatte/ Rechte Endplatte	Innenecke (Gehrungspaar 4-tlg.)	Art. Nr. 86160
86160	86165	86161	86163	86167/86168	86162	Formatnummer
244 x 240 x 285	119 x 240 x 285	244 x 240 x 285	119 x 240 x 285	passend zum Rinnenquers.	(2x) 359/119 x 240 x 285	Nennmaß - cm
4,000	8,000					Herstellmaß mm
18,250/Stück	8,900/Stück	17,750/Stück	8,600/Stück	0,300/Stück	45,000/Paar	m - Stück
1 Stück	2 Stück	1 Stück	2 Stück		1 Paar	St./Paar - kg
0,250	0,250					Paket - St./Paar
18,250	17,800	17,750	17,200		45,000	Paket - m
						Paket - kg
						Palette - m
						Palette - kg
Alb	Alb	Alb	Alb	Alb	Alb	Produktnorm
700-86160	700-86165	700-86161	700-86163	700-86167/68	700-86162	neutral 10
Preisgr. A716 (St.)	Preisgr. A654 (St.)	Preisgr. A742 (St.)	Preisgr. A702 (St.)	Preisgr. A547 (St.)	Preisgr. A804 (Paar)	(aktivweiß glzd.)
701-86160	701-86165	701-86161	701-86163	701-86167/68	701-86162	neutral 10
Preisgr. A716 (St.)	Preisgr. A654 (St.)	Preisgr. A742 (St.)	Preisgr. A702 (St.)	Preisgr. A547 (St.)	Preisgr. A804 (Paar)	(aktivweiß matt)
552001-86160	552001-86165	552001-86161	552001-86163	552001-86167/68	552001-86162	
Preisgr. A723 (St.)	Preisgr. A663 (St.)	Preisgr. A748 (St.)	Preisgr. A705 (St.)	Preisgr. A556 (St.)	Preisgr. A814 (Paar)	azur aktiv
552002-86160	552002-86165	552002-86161	552002-86163	552002-86167/68	552002-86162	
Preisgr. A723 (St.)	Preisgr. A663 (St.)	Preisgr. A748 (St.)	Preisgr. A705 (St.)	Preisgr. A556 (St.)	Preisgr. A814 (Paar)	azur hell
5716-86160²	5716-86165²	5716-86161²	5716-86163²	5716-86167/68²	5716-86162²	neutral 1
Preisgr. A723 (St.)	Preisgr. A663 (St.)	Preisgr. A748 (St.)	Preisgr. A705 (St.)	Preisgr. A556 (St.)	Preisgr. A814 (Paar)	(tiefschwarz)

¹ Passender Flüsterablauf „Silent W2000“ siehe S. 444

² Produktionsbedingt können Farbunterschiede zwischen Formstücken und Flächenware auftreten.

Bitte beachten: Aufgrund der Formgebung ist keine Außenecke möglich.



HANDFASSE (T-STÜCKE)

Bitte beachten: zur Verlegung der T-Stücke die XPS-Verlegehilfe verwenden



Zubehör XPS-Verlegehilfe	Beckenrandstein	„halber“ Beckenrandstein	Innenecke (Gehrungspaar)	Außenecke (Gehrungspaar) Eckradius 30 mm	Anfangsstück links/rechts	Art. Nr. 55850
	55850	55855	55852	55856	55857/55858	Formatnummer
	244 x 20/60 x 56	119 x 20/60 x 56	(2x) 119/175 x 20/60 x 56	(2x) 236/183 x 20/60 x 56	244 x 20/60 x 56	Nennmaß - cm
	4,000	8,000				Herstellmaß mm
0,020/Stück	0,900/Stück	0,440/Stück	0,440/Paar	0,800/Paar	0,910/Stück	m - Stück
	18	36				St./Paar - kg
	4,500	4,500				Paket - Stück
	16,200	15,840				Paket - m
						Paket - kg
						Palette - m
						Palette - kg
	Alb	Alb	Alb	Alb	Alb	Produktnorm
F-190	700-55850	700-55855	700-55852	700-55856	700-55857/58	neutral 10
Preisgr. A434 (St.)	Preisgr. A467 (St.)	Preisgr. A438 (St.)	Preisgr. A577 (Paar)	Preisgr. A587 (Paar)	Preisgr. A480 (St.)	(aktivweiß glzd.)
F-190	701-55850	701-55855	701-55852	701-55856	701-55857/58	neutral 10
Preisgr. A434 (St.)	Preisgr. A467 (St.)	Preisgr. A438 (St.)	Preisgr. A577 (Paar)	Preisgr. A587 (Paar)	Preisgr. A480 (St.)	(aktivweiß matt)
F-190	552001-55850	552001-55855	552001-55852	552001-55856	552001-55857/58	
Preisgr. A434 (St.)	Preisgr. A471 (St.)	Preisgr. A441 (St.)	Preisgr. A581 (Paar)	Preisgr. A593 (Paar)	Preisgr. A484 (St.)	azur aktiv
F-190	552002-55850	552002-55855	552002-55852	552002-55856	552002-55857/58	
Preisgr. A434 (St.)	Preisgr. A471 (St.)	Preisgr. A441 (St.)	Preisgr. A581 (Paar)	Preisgr. A593 (Paar)	Preisgr. A484 (St.)	azur hell
F-190	5716-55850²	5716-55855²	5716-55852²	5716-55856²	5716-55857/58²	neutral 1
Preisgr. A434 (St.)	Preisgr. A471 (St.)	Preisgr. A441 (St.)	Preisgr. A581 (Paar)	Preisgr. A593 (Paar)	Preisgr. A484 (St.)	(tiefschwarz)

² Produktionsbedingt können Farbunterschiede zwischen Formstücken und Flächenware auftreten.

Für die auf dieser Seite gezeigten Produkte sind auf Wunsch konische Zuschnitte möglich.
Für die auf dieser Seite gezeigten Produkte wird kein Palettenrabatt gewährt.



Die dargestellten Produkte können auch in anderen Farben der Serie Chroma gefertigt werden. Gerne prüfen wir die Möglichkeit einer solchen Sonderproduktion im Einzelfall.

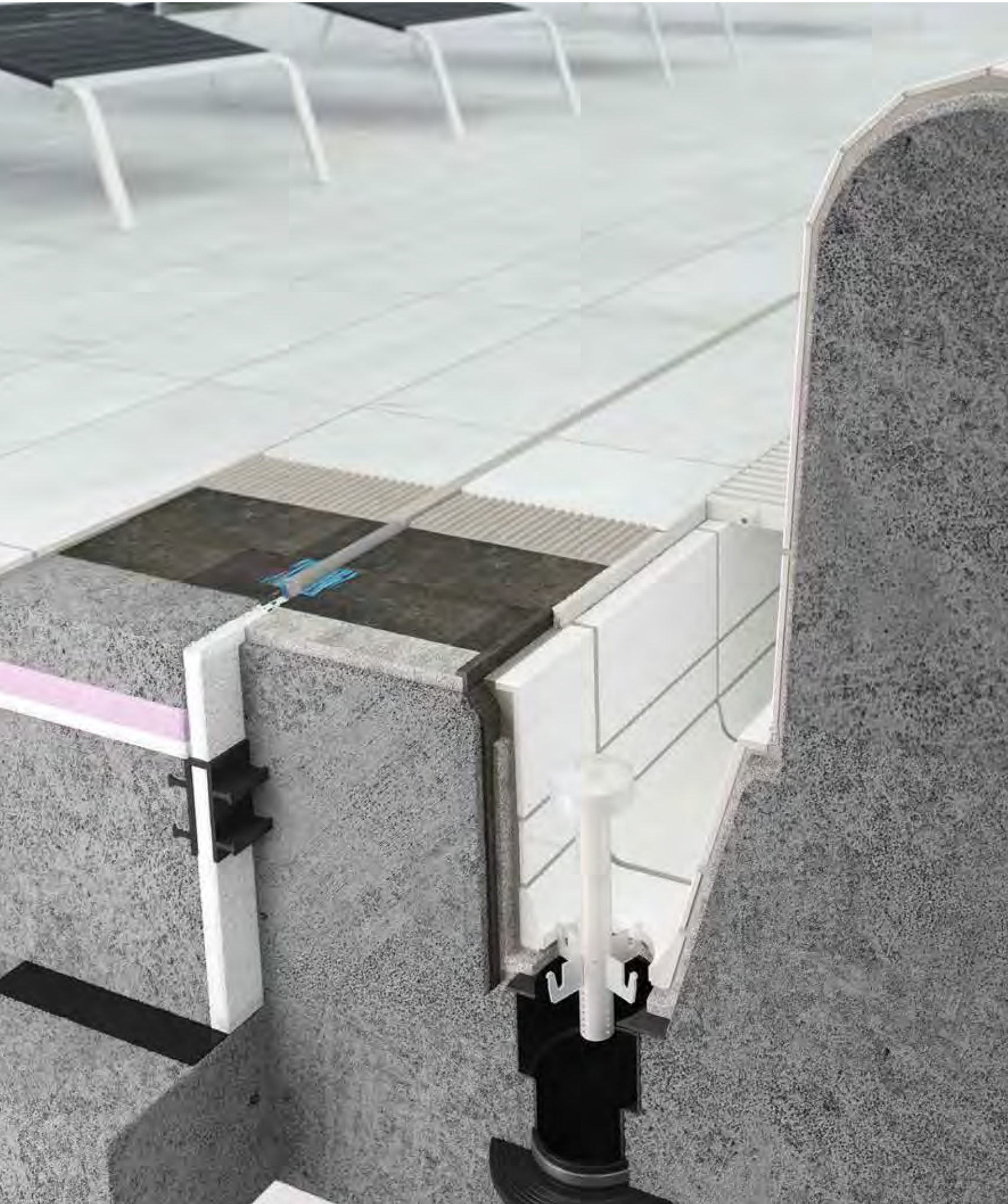



Badgenuss mit Panoramablick

Charakteristisches Kennzeichen des Beckenkopfsystems St. Moritz ist der hochgeführte Beckenrand. Dadurch ergeben sich Vorteile nicht nur beim Beckenbau. Die Badegäste genießen den Ausblick aus ihrer gegenüber konventioneller Bauweise erhöhten Position.

Das System mit integrierter Handfasse ist auf die Anforderungen von Freizeit- und Erlebnisbädern zugeschnitten, bewährt sich aber auch in Privat- und Hotelbädern. Bei dieser Konstruktion fließt überlaufendes Wasser an den Außenwänden des Beckens herab in die außen liegende, mit einem Kunststoffrost abgedeckte Rinne. Kostenvorteile ergeben sich vor allem durch die geringere Gründungstiefe für das Becken.

Projekt: Hotel aja / Standort: Garmisch-Partenkirchen, Deutschland / Architekt: SMAP SEEGER MÜLLER Berlin (Deutschland) und Büro Korb, Hamburg (Deutschland) / Serie: Quarzit / Foto: Fotodesign Peters



St. Moritz

Mit dem System St. Moritz lassen sich beliebige Beckenkopfbreiten mit unterschiedlichen Randabdeckungen realisieren. Attraktiv ist das „erhabene“ Becken aber auch für die Badbesucher: Sie haben einen freien Ausblick auf die Umgebung und können mit Menschen außerhalb des Beckens nahezu auf Augenhöhe kommunizieren.

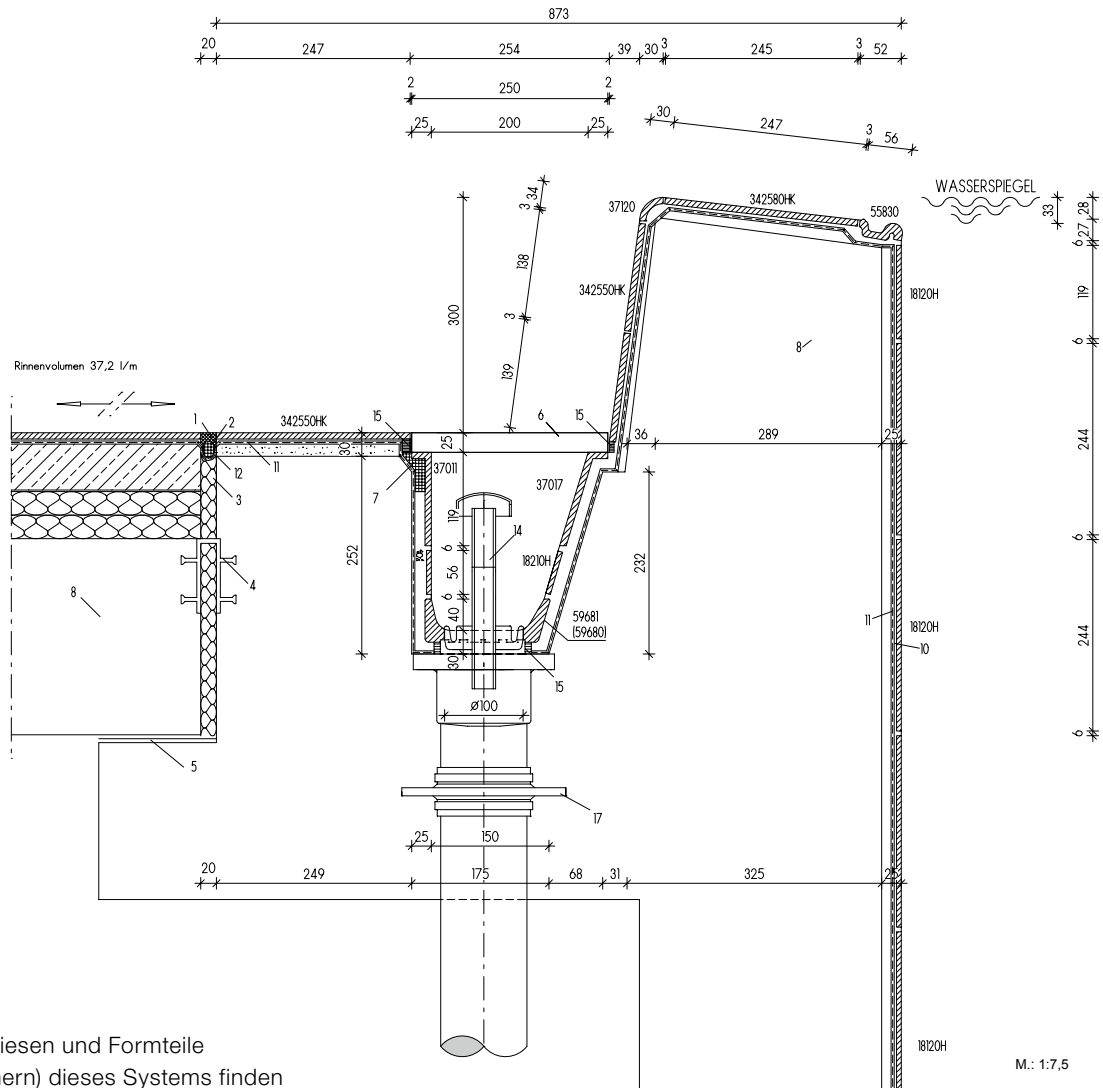

Die einzelnen Fliesen und Formteile
(= Formatnummern) dieses Systems finden
Sie unter:

- 18120H = Chroma Fliese (Seite 334 ff)
- 55830 = Handfass-Stein (Seite 367)
- 342580HK = Quarzit Rasterprofilfliese (Seite 277)
- 37120 = Radialeiste (Seite 419)
- 342550HK = Quarzit Fliese (Seite 277)
- 37017 = Schenkelplatte schäg (Seite 433)
- 18210H = Chroma Fliese (Seite 334 ff)
- 37011 = Schenkelplatte gerade (Seite 433)
- 59681 (59680) = Rinnenschale (Seite 433)
- Flüsterablauf Silent 100 (Seite 444)
- Abdeckrost (Seite 442)

Legende:

- 01 UW-Silikon
- 02 Geschlossenzellige PE-Schaumstoffrundschnur
- 03 Wasserbeständiges elastisches Füllmaterial
- 04 Fugenband-Profil

- 05 Gleitlager
- 06 Agrob Buchtal Kunststoff-Abdeckrost
- 07 Kapillarsperre Verguss (Verwahrung)
- 08 Beton mit hohem Wassereindringwiderstand
(nach DIN EN 206/DIN 1045/DAfStB-WU-Richtlinie)
- 09 Konventionelle Dickbettverlegung
- 10 Dünnbettverlegung auf Zementputz
(P III, CS IV ohne Kalkzusatz) (DIN 18157)
- 11 Verbundabdichtung
- 12 Dichtband
- 13 Agrob Buchtal Flüsterablauf
„Silent W 2000“
- 14 Agrob Buchtal Ablaufbelüfter „Silent 100“
- 15 Objekt Fugenepoxi
- 16 Agrob Buchtal Steinzeug-Rinnenschale
- 17 Einlaufkasten/Ablaufrohr und Dichtflansch





Flexible Alternative

Bei diesem System ist die hochliegende Überflutungskante als Handfasse ausgebildet. Die abgedeckte Rinne, die das überlaufende Wasser aufnimmt, liegt vom Becken aus gesehen unmittelbar dahinter und sorgt durch ihre abgerundete Form für einen weichen, geräuscharmen Einlauf.

Durch seine Bauweise ist das System Berlin unter anderem für den Einsatz in Freizeit- und Erlebnisbäder geeignet. Mit der unmittelbar an das Becken angrenzenden Überlaufrinne kommt es als Alternative zum Beckenkopfsystem Wiesbaden in Betracht, bietet jedoch den Vorteil größerer Flexibilität: Breite und Tiefe der Rinne sind beim Beckenkopfsystem Berlin variabel und lassen sich exakt an die örtlichen Gegebenheiten anpassen.

Projekt: Hallenbad / Standort: Münster-Kinderhaus, Deutschland / Architekt: Janßen Bär Partnerschaft /
Serie: Beckenkopfsystem Berlin, Chroma, Kauri, Unique, Valley / Foto: Stephan Brendgen



Berlin

Als Zubehör sind Rinnenabdeckungen aus Kunststoff erhältlich. Der ebenfalls für die Kombination mit Berlin geeignete Flüsterablauf Silent 100 von Agrob Buchtal hilft, den Geräuschpegel im Bad wirksam zu senken.

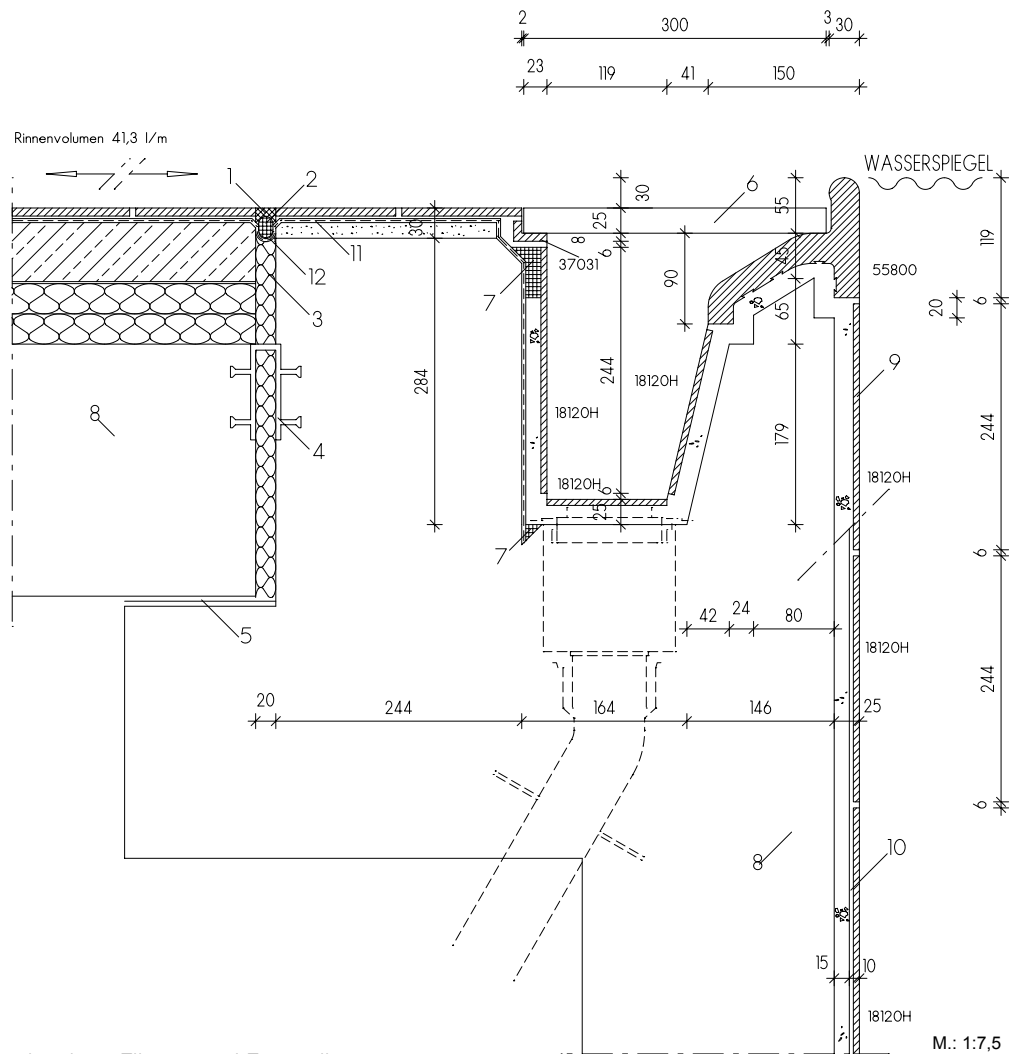

Die einzelnen Fliesen und Formteile
(= Formatnummern) dieses Systems finden
Sie unter:

18120H = Chroma Fliese (Seite 334 ff)
55800 = Beckenrandstein (Seite 413)
37031 = Rostauflegewinkel (Seite 433)
Abdeckrost (Seite 442)

Legende:

01 UW-Silikon
02 Geschlossenzellige PE-Schaumstoffrundschnur
03 Wasserbeständiges elastisches Füllmaterial
04 Fugenband-Profil
05 Gleitlager
06 Agrob Buchtal Kunststoff-Abdeckrost
07 Kapillarsperre Verguss (Verwahrung)

08 Beton mit hohem Wassereindringwiderstand
(nach DIN EN 206/DIN
1045/DAfStB-WU-Richtlinie)
09 Konventionelle Dickbettverlegung
10 Dünnbettverlegung auf Zementputz
(P III, CS IV ohne Kalkzusatz) (DIN 18157)
11 Verbundabdichtung
12 Dichtband
13 Agrob Buchtal Flüsterablauf
„Silent W 2000“
14 Agrob Buchtal Ablaufbelüfter „Silent 100“
15 Objekt Fugenepoxi
16 Agrob Buchtal Steinzeug-Rinnenschale
17 Einlaufkasten/Ablaufrohr und Dichtflansch





Gestalten mit Randsteinen

Wie das Beckenkopfsystem Berlin (vorgestellt auf Seite 401) verfügt auch das System Zürich über eine hochliegende Überflutungskante, die zugleich als Handfasse dient. Allerdings ist die mit einem Kunststoffrost abgedeckte Rinne durch Randsteine vom Becken getrennt.

Durch die Kombination mit Beckenrandsteinen zwischen Überlaufkante und Ablaufrinne ist das System bestens für die Verwendung in Freizeit- und Erlebnisbädern geeignet. Zudem bietet Zürich viel Spielraum in bautechnischer und ästhetischer Hinsicht. So lassen sich je nach Bedarf unterschiedliche Rinnenvolumen realisieren.

Projekt: Kombibad Gropiusstadt / Standort: Berlin, Deutschland / Architekt: Veauthier Meyer Architekten /
Serie: Beckenkopfsystem Zürich / Foto: Jochen Stüber



Zürich

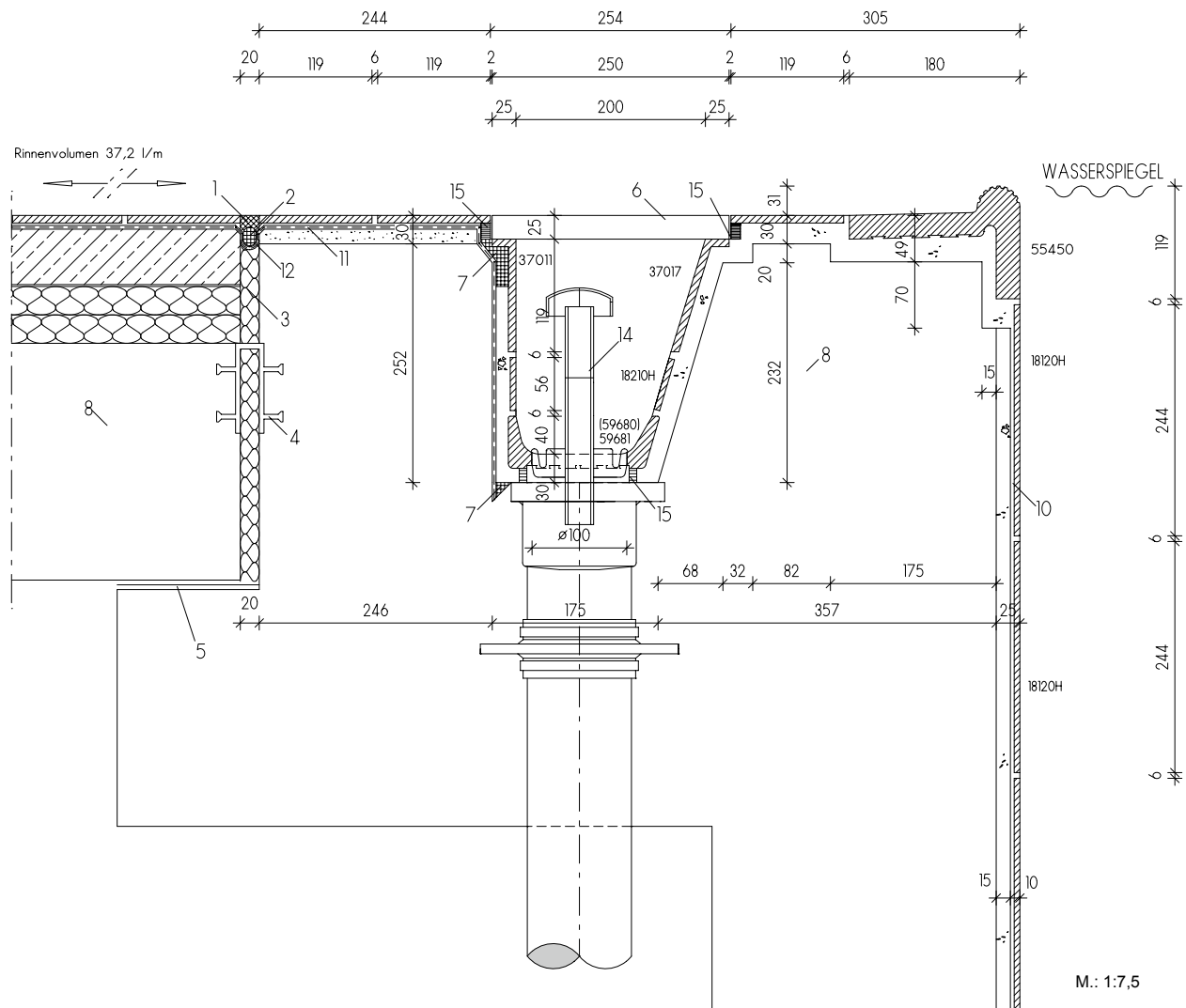

Die einzelnen Fliesen und Formteile
(= Formatnummern) dieses Systems finden
Sie unter:

18120H = Chroma Fliese (Seite 334 ff)
55450 = Beckenrandstein (Seite 412)
37017 = Schenkelplatte (Seite 433)
18210H = Chroma Fliese (Seite 334 ff)
59681 = Rinnenschale mit Ablauf (Seite 433)
59680 = Rinnenschale (Seite 433)
37011 = Schenkelplatte (Seite 433)
Abdeckrost (Seite 442)
Flüsterablauf Silent 100 (Seite 444)

Legende:

01 UW-Silikon
02 Geschlossenzellige PE-Schaumstoffrundschnur
03 Wasserbeständiges elastisches Füllmaterial
04 Fugenband-Profil
05 Gleitlager
06 Agrob Buchtal Kunststoff-Abdeckrost
07 Kapillarsperre Verguss (Verwahrung)

08 Beton mit hohem Wassereindringwiderstand
(nach DIN EN 206/DIN
1045/DAfStB-WU-Richtlinie)
09 Konventionelle Dickbettverlegung
10 Dünnbettverlegung auf Zementputz
(P III, CS IV ohne Kalkzusatz) (DIN 18157)
11 Verbundabdichtung
12 Dichtband
13 Agrob Buchtal Flüsterablauf
„Silent W 2000“
14 Agrob Buchtal Ablaufbelüfter „Silent 100“
15 Objekt Fugenepoxi
16 Agrob Buchtal Steinzeug-Rinnenschale
17 Einlaufkasten/Ablaufrohr und Dichtflansch



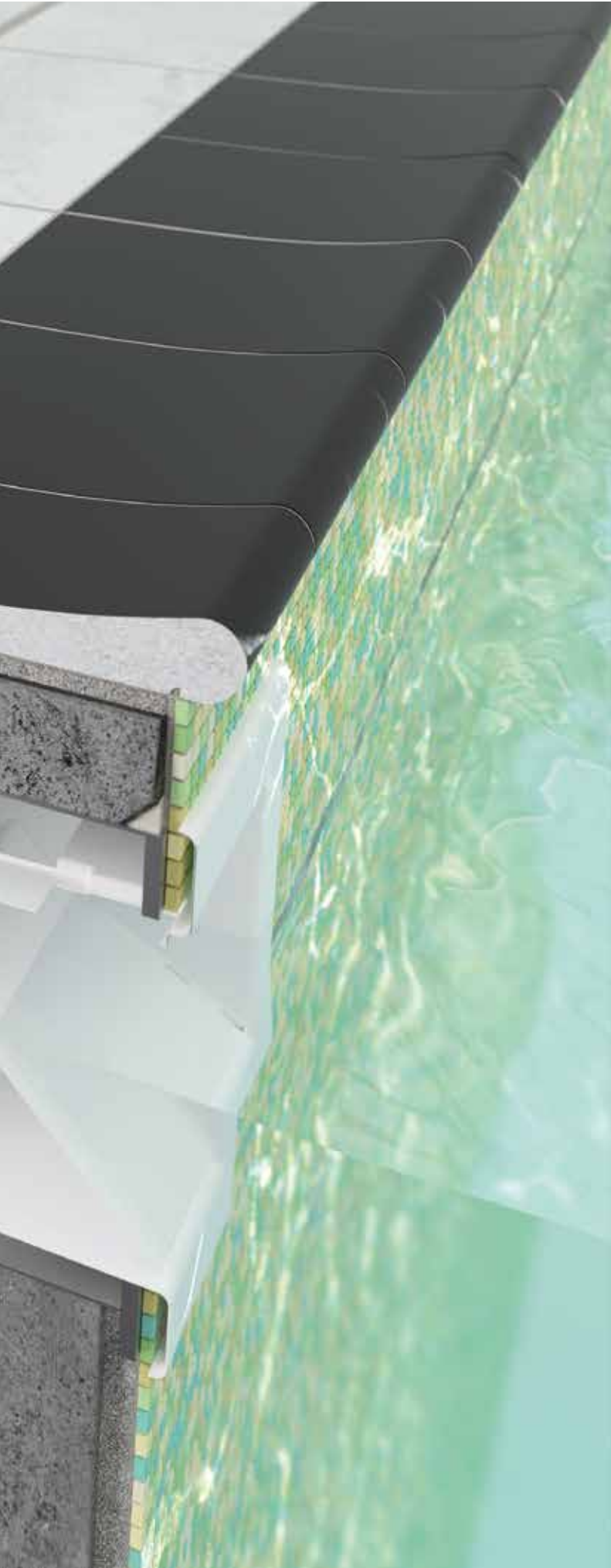

Low Budget für privat Schwimmbäder

Wo es um eine kostengünstige Lösung für private Pools geht, bietet sich das System Skimmer an. Für die Wassertechnik ist nur geringer Aufwand nötig. In puncto Gestaltung bietet Skimmer individuelle Freiheiten durch unterschiedliche Ausführungen des Beckenrandes und die Wahl geeigneter Formsteine.

408 SYSTEM SKIMMER

Projekt: Villa in Süddeutschland / Architekt: Eigenplanung / Serie: Naturkeramik / Foto: Herbert Bürger



Skimmer

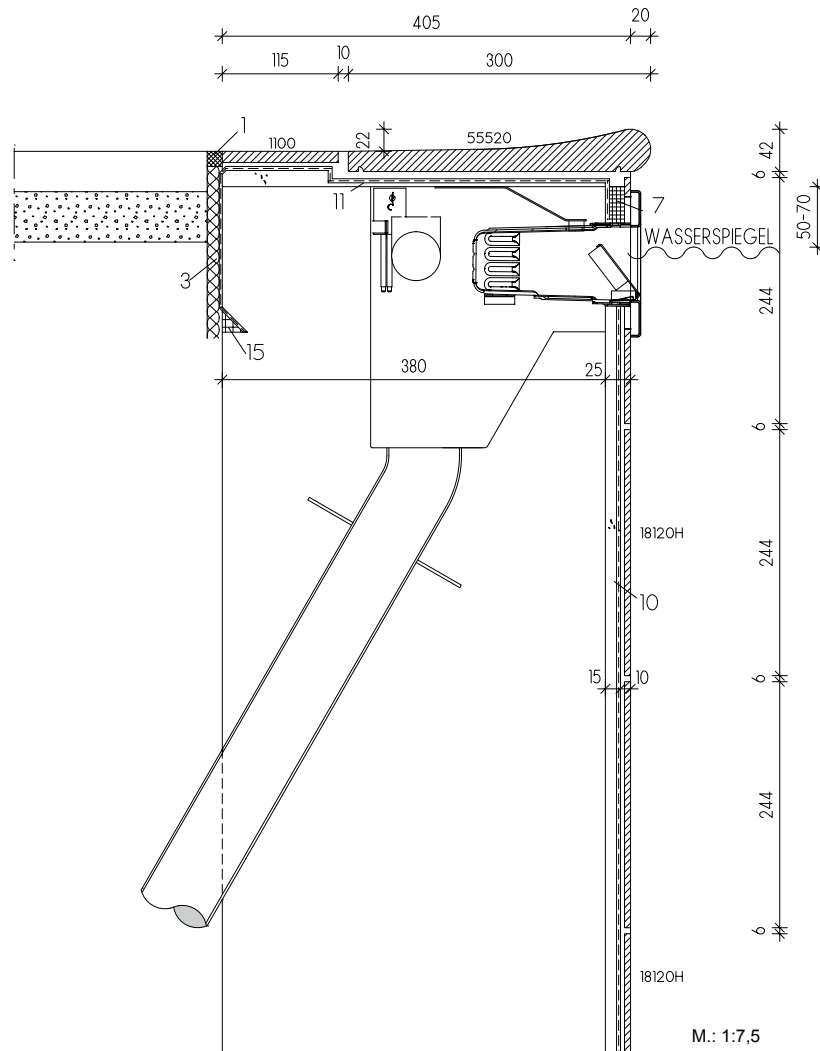

Die einzelnen Fliesen und Formteile
(= Formatnummern) dieses Systems finden
Sie unter:

18120H = Chroma Fliese (Seite 334 ff)
55520 = Beckenrandstein Residence (Seite 413)

Legende:

01 UW-Silikon
02 Geschlossenzellige PE-Schaumstoffrundschnur
03 Wasserbeständiges elastisches Füllmaterial
04 Fugenband-Profil
05 Gleitlager
06 Agrob Buchtal Kunststoff-Abdeckrost
07 Kapillarsperre Verguss (Verwahrung)

08 Beton mit hohem Wassereindringwiderstand
(nach DIN EN 206/DIN
1045/DAfStB-WU-Richtlinie)
09 Konventionelle Dickbettverlegung
10 Dünnbettverlegung auf Zementputz
(P III, CS IV ohne Kalkzusatz) (DIN 18157)
11 Verbundabdichtung
12 Dichtband
13 Agrob Buchtal Flüsterablauf
„Silent W 2000“
14 Agrob Buchtal Ablaufbelüfter „Silent 100“
15 Objekt Fugenepoxi
16 Agrob Buchtal Steinzeug-Rinnenschale
17 Einlaufkasten/Abflrohr und Dichtflansch

410 BECKENRANDSTEINE

Projekt: Terrassenbad / Standort: Baden, Schweiz / Architekt: Bridevaux M. + Zimmermann M. Architekten AG, Baden /
Serie: Beckenrandsteine, Plural unglasiert / Foto: Adriano Faragulo

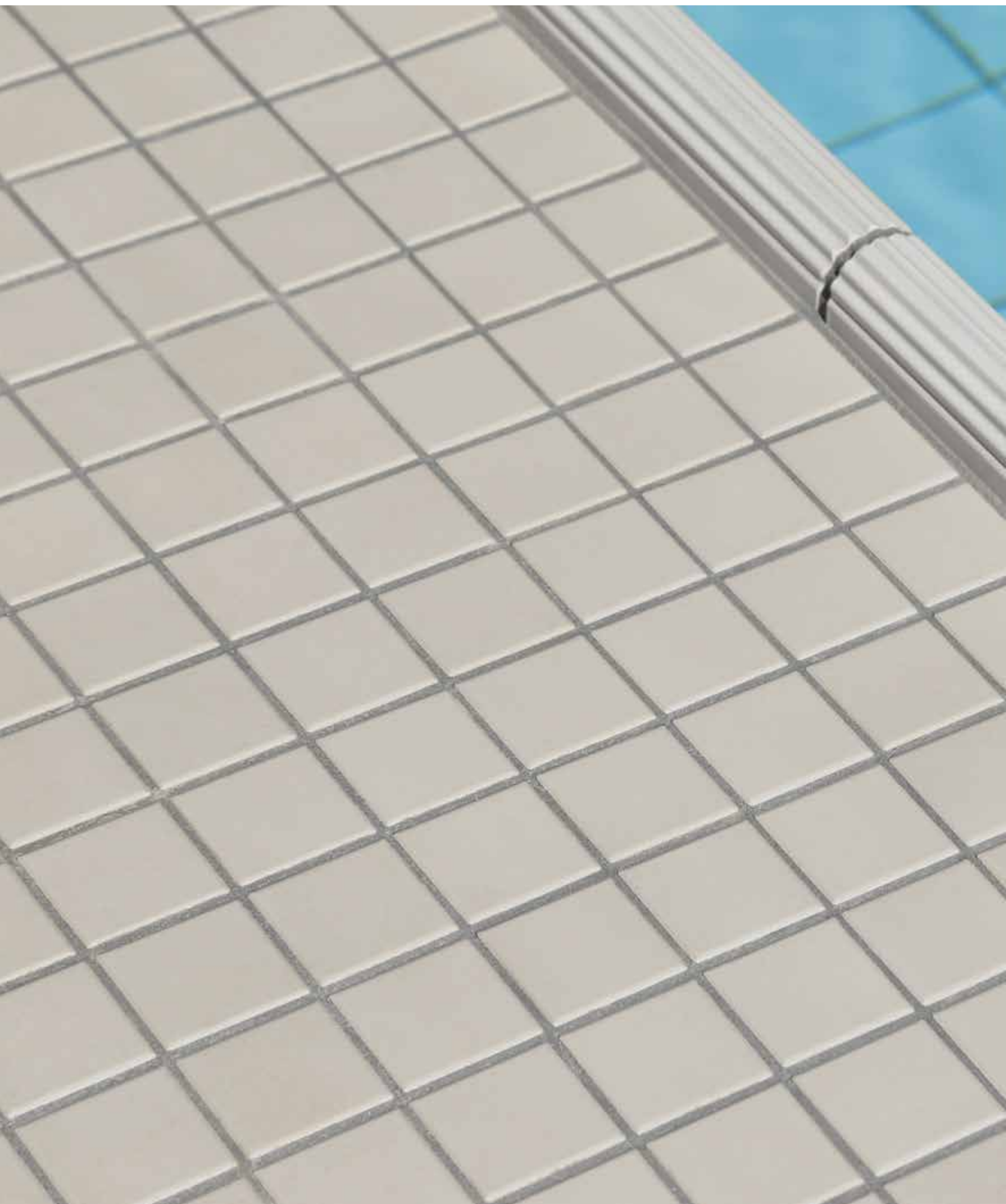



Am Beckenrand

Beckenrandsteine finden sich in allen Beckenrandausführungen, bei denen die Kante nicht bereits Bestandteil des Beckenkopfsystems ist, wie beispielsweise beim System Wiesbaden. Oder zur Begrenzung des Beckens an Stellen, an denen keine Ablaufrinne vorgesehen ist. Sie haben mehrere Funktionen: neben einer farblichen Markierung der Beckenkante sowohl innerhalb als auch außerhalb des Beckens, bieten Beckenrandsteine vor allem sicheren Halt für den Schwimmer und sind daher auch ein wichtiges Sicherheitsmerkmal. Für unterschiedliche Bauarten des Beckenrandes stehen verschiedene Varianten zur Verfügung, die zum Teil bauartübergreifend eingesetzt werden können.

z. B. für Systeme Zürich, Wiesbaden tiefliegender Wasserspiegel, „Skimmer“ etc.

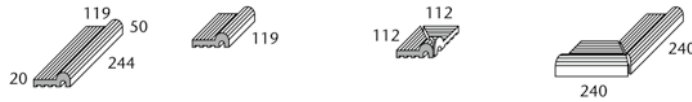

Art. Nr. 55440

	Beckenrandstein	„halber“ Beckenrandstein	Innenecke (Gehrungspaar)	Außenecke (Gehrungspaar) Eckradius 30 mm
Formatnummer	55440	55445	55442	55446
Nennmaß - cm				
Herstellmaß mm	244 x 119/50 x 20	119 x 119/50 x 20	(2x) 112 x 112/50 x 20	(2x) 240 x 119/50 x 20
m - Stück	4,000	8,000		
St./Paar - kg	1,550/Stück	0,780/Stück	0,600/Paar	2,500/Paar
Paket - St./Paar	10 Stück	20 Stück	2 Paar	5 Paar
Paket - m	2,500	2,500		
Paket - kg	15,500	15,600	1,200	12,500
Palette - m				
Palette - kg				
Produktnorm	Alb	Alb	Alb	Alb
Trittsicherheit	-/C	-/C	-/C	-/C
graubeige	900-55440	900-55445	900-55442	900-55446
Preisgr. A511 (St.)		Preisgr. A467 (St.)	Preisgr. A533 (Paar)	Preisgr. A608 (Paar)
900 graubeige	700-55440	700-55445	700-55442	700-55446
Preisgr. A528 (St.)		Preisgr. A474 (St.)	Preisgr. A545 (Paar)	Preisgr. A625 (Paar)
700 n10/weiß glzd.	900-55440	701-55445	701-55442	701-55446
Preisgr. A528 (St.)		Preisgr. A474 (St.)	Preisgr. A545 (Paar)	Preisgr. A625 (Paar)
900 graubeige	701-55440	701-55445	701-55442	701-55446
Preisgr. A528 (St.)		Preisgr. A474 (St.)	Preisgr. A545 (Paar)	Preisgr. A625 (Paar)
701 n10/weiß matt	552001-55440	552001-55445	552001-55442	552001-55446
Preisgr. A545 (St.)		Preisgr. A484 (St.)	Preisgr. A560 (Paar)	Preisgr. A645 (Paar)
900 graubeige	552001-55440	552001-55445	552001-55442	552001-55446
Preisgr. A545 (St.)		Preisgr. A484 (St.)	Preisgr. A560 (Paar)	Preisgr. A645 (Paar)
552001 azur aktiv	552002-55440	552002-55445	552002-55442	552002-55446
Preisgr. A545 (St.)		Preisgr. A484 (St.)	Preisgr. A560 (Paar)	Preisgr. A645 (Paar)
900 graubeige	552002-55440	552002-55445	552002-55442	552002-55446
Preisgr. A545 (St.)		Preisgr. A484 (St.)	Preisgr. A560 (Paar)	Preisgr. A645 (Paar)
552002 azur hell	5716-55440²	5716-55445²	5716-55442²	5716-55446²
Preisgr. A545 (St.)		Preisgr. A484 (St.)	Preisgr. A560 (Paar)	Preisgr. A645 (Paar)
900 graubeige	5716-55440²	5716-55445²	5716-55442²	5716-55446²
Preisgr. A545 (St.)		Preisgr. A484 (St.)	Preisgr. A560 (Paar)	Preisgr. A645 (Paar)
5716 n1/schwarz	5716-55440²	5716-55445²	5716-55442²	5716-55446²
Preisgr. A545 (St.)		Preisgr. A484 (St.)	Preisgr. A560 (Paar)	Preisgr. A645 (Paar)



Bei diesen Formteilen sind Überhang und Wulst in den jeweiligen Farben glasiert.

² Produktionsbedingt können Farbunterschiede zwischen Formstücken und Flächenware auftreten.

z. B. für Systeme Zürich, Wiesbaden tiefliegender Wasserspiegel, „Skimmer“ etc.



Art. Nr. 55450

	Beckenrandstein Unterkante unglasiert	„halber“ Beckenrandstein	Innenecke (Gehrungspaar)	Außenecke (Gehrungspaar) Eckradius 30 mm
Formatnummer	55450	55455	55452	55456
Nennmaß - cm				
Herstellmaß mm	244 x 180/119 x 28	119 x 180/119 x 28	(2x) 173 x 173 x 28	(2x) 240 x 180/119 x 28
m - Stück	4,000	8,000		
St./Paar - kg	3,700/Stück	1,800/Stück	1,800/Paar	5,500/Paar
Paket - St./Paar	4 Stück	8 Stück	2 Paar	1 Paar
Paket - m	1,000	1,000		
Paket - kg	14,800	14,400	3,600	5,500
Palette - m				
Palette - kg				
Produktnorm	Alb	Alb	Alb	Alb
Trittsicherheit	-/C	-/C	-/C	-/C
81 n10/weiß	900039-55450	900039-55455	900039-55452	900039-55456
Preisgr. A625 (St.)		Preisgr. A560 (St.)	Preisgr. A663 (Paar)	Preisgr. A748 (Paar)
700 n10/weiß glzd.	900464-55450	900464-55455	900464-55452	900464-55456
Preisgr. A625 (St.)		Preisgr. A560 (St.)	Preisgr. A663 (Paar)	Preisgr. A748 (Paar)
81 n10/weiß	900566-55450	900566-55455	900566-55452	900566-55456
Preisgr. A645 (St.)		Preisgr. A573 (St.)	Preisgr. A683 (Paar)	Preisgr. A766 (Paar)
701 n10/weiß matt	900674-55450	900674-55455	900674-55452	900674-55456
Preisgr. A645 (St.)		Preisgr. A573 (St.)	Preisgr. A683 (Paar)	Preisgr. A766 (Paar)
81 n10/weiß	900615-55450²	900615-55455²	900615-55452²	900615-55456²
Preisgr. A645 (St.)		Preisgr. A573 (St.)	Preisgr. A683 (Paar)	Preisgr. A766 (Paar)
552001 azur aktiv	900615-55450²	900615-55455²	900615-55452²	900615-55456²
Preisgr. A645 (St.)		Preisgr. A573 (St.)	Preisgr. A683 (Paar)	Preisgr. A766 (Paar)
81 n10/weiß	5716-55450²	5716-55455²	5716-55452²	5716-55456²
Preisgr. A645 (St.)		Preisgr. A573 (St.)	Preisgr. A683 (Paar)	Preisgr. A766 (Paar)
5716 n1/schwarz	5716-55450²	5716-55455²	5716-55452²	5716-55456²
Preisgr. A645 (St.)		Preisgr. A573 (St.)	Preisgr. A683 (Paar)	Preisgr. A766 (Paar)

Bei diesen Formteilen sind Überhang und Wulst in den jeweiligen Farben glasiert, Trittsicherheit ist weiß (81).

¹ Abdeckkante siehe S. 442, Rinnenschale siehe S. 433

² Produktionsbedingt können Farbunterschiede zwischen Formstücken und Flächenware auftreten.

Für die auf dieser Seite gezeigten Produkte wird kein Palettenrabatt gewährt.

Die dargestellten Produkte können auch in anderen Farben der Serie Chroma und Chroma non-slip gefertigt werden. Gerne prüfen wir die Möglichkeit einer solchen Sonderproduktion im Einzelfall.

z. B. für Systeme Zürich, Wiesbaden tiefliegender Wasserspiegel, „Skimmer“ etc.

25 x 30 cm

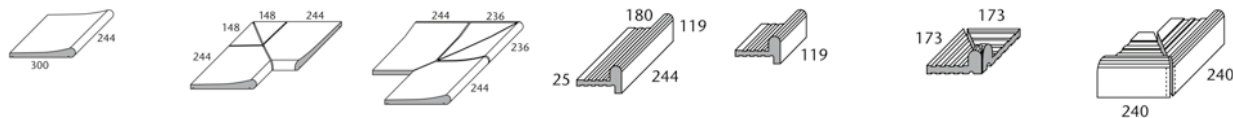

Residence ²	Innenecke 4-teilig	Außenecken 4-teilig	Beckenrandstein	„halber“ Beckenrandstein	Innenecke (Gehrungspaar)	Außenecke (Gehrungspaar) Eckradius 30 mm	Formatnummer
55520	55522	55526	55460	55465	55462	55466	Nennmaß - cm/in
25 x 30 / 10 x 12	(2x) 398/102 x 300 x 20/42	(2x) 490 x 300 x 20/42	244 x 180/119 x 25	119 x 180/119 x 25	(2x) 173 x 173 x 25	(2x) 240 x 180/119 x 25	Herstellmaß mm
4,000			4,000	8,000			m - Stück
4,300/Stück	11,900/Stück	11,900/Stück	3,720/Stück	1,800/Stück	1,500/Paar	5,700/Paar	St./Paar - kg
4 Stück	1 Stück	1 Stück	4 Stück	8 Stück	4 Paar	1 Paar	Paket - St./Paar
1,000			1,000	1,000			Paket - m
17,200	11,900	11,900	14,880	14,400	6,000	5,700	Paket - kg
							Palette - m
							Palette - kg
Alb	Alb	Alb	Alb	Alb	Alb	Alb	Produktnorm
-/B	-/B	-/B					Trittsicherheit
			700-55460	700-55465	700-55462	700-55466	neutral 10
			Preisgr. A625 (St.)	Preisgr. A560 (St.)	Preisgr. A654 (Paar)	Preisgr. A734 (Paar)	(aktivweiß glzd.)
			701-55460	701-55465	701-55462	701-55466	neutral 10
			Preisgr. A625 (St.)	Preisgr. A560 (St.)	Preisgr. A654 (Paar)	Preisgr. A734 (Paar)	(aktivweiß matt)
			552001-55460	552001-55465	552001-55462	552001-55466	azur aktiv
			Preisgr. A645 (St.)	Preisgr. A573 (St.)	Preisgr. A683 (Paar)	Preisgr. A748 (Paar)	
			552002-55460	552002-55465	552002-55462	552002-55466	azur hell
			Preisgr. A645 (St.)	Preisgr. A573 (St.)	Preisgr. A683 (Paar)	Preisgr. A748 (Paar)	
			5716-55460 ³	5716-55465 ³	5716-55462 ³	5716-55466 ³	neutral 1
			Preisgr. A645 (St.)	Preisgr. A573 (St.)	Preisgr. A683 (Paar)	Preisgr. A748 (Paar)	(tiefschwarz)
91-55520	91-55522	91-55526					neutral 10
Preisgr. A514 (St.)	Preisgr. A668 (Paar)	Preisgr. A741 (Paar)					(aktivweiß)
553001-55520	553001-55522	553001-55526					azur aktiv
Preisgr. A528 (St.)	Preisgr. A683 (Paar)	Preisgr. A757 (Paar)					

² Für diesen Artikel sind auf Wunsch konische Zuschnitte möglich.

³ Produktionsbedingt können Farbunterschiede zwischen Formstücken und Flächenware auftreten.

Bei diesen Formteilen sind Überhang und Wulst in den jeweiligen Farben glasiert.



für System Berlin



			Beckenrandstein	„halber“ Beckenrandstein	Innenecke (Gehrungspaar)	Außenecke (Gehrungspaar) Eckradius 30 mm	Art. Nr. 55800
			55800	55805	55802	55806	Formatnummer
			244 x 150/119 x 25/30	119 x 150/119 x 25/30	(2x) 143 x 143/119	(2x) 240 x 150A/119 x 25/30	Nennmaß - cm/in
			4,000	8,000			Herstellmaß mm
			3,700/Stück	1,800/Stück	1,600/Paar	5,400/Paar	m - Stück
			3 Stück	6 Stück	1 Paar	1 Paar	St./Paar - kg
			0,750	0,750			Paket - St./Paar
			11,100	10,800	1,600	5,400	Paket - m
							Paket - kg
							Palette - m
							Palette - kg
			Alb	Alb	Alb	Alb	Produktnorm
			700-55800	700-55805	700-55802	700-55806	neutral 10
			Preisgr. A638 (St.)	Preisgr. A577 (St.)	Preisgr. A668 (Paar)	Preisgr. A754 (Paar)	(aktivweiß glzd.)
			701-55800	701-55805	701-55802	701-55806	neutral 10
			Preisgr. A638 (St.)	Preisgr. A577 (St.)	Preisgr. A668 (Paar)	Preisgr. A754 (Paar)	(aktivweiß matt)
			552001-55800	552001-55805	552001-55802	552001-55806	azur aktiv
			Preisgr. A654 (St.)	Preisgr. A587 (St.)	Preisgr. A683 (Paar)	Preisgr. A766 (Paar)	
			552002-55800	552002-55805	552002-55802	552002-55806	azur hell
			Preisgr. A654 (St.)	Preisgr. A587 (St.)	Preisgr. A683 (Paar)	Preisgr. A766 (Paar)	
			5716-55800 ³	5716-55805 ³	5716-55802 ³	5716-55806 ³	neutral 1
			Preisgr. A654 (St.)	Preisgr. A587 (St.)	Preisgr. A683 (Paar)	Preisgr. A766 (Paar)	(tiefschwarz)



Die dargestellten Produkte können auch in anderen Farben der Serie Chroma und Chroma non-slip gefertigt werden. Gerne prüfen wir die Möglichkeit einer solchen Sonderproduktion im Einzelfall.

¹ Abdeckroste siehe S. 442, Rinnenschale siehe S. 433

³ Produktionsbedingt können Farbunterschiede zwischen Formstücken und Flächenware auftreten.

Für die auf dieser Seite gezeigten Produkte wird kein Palettenrabatt gewährt.







Vielfalt praktischer Formteile

Wie komplex eine Beckengestaltung auch sein mag – eine Vielzahl an durchdachten und massiven Formteilen aus Keramik garantiert eine solide Realisierung. Aus den verschiedenen Systemen lassen sich nach dem Baukastenprinzip die passenden Beckenabschlüsse kombinieren. Dabei sorgen spezielle Formen wie abgerundete Kanten durch Radialleisten, Hohlkehlen oder Kehlsockel in diversen Ausführungen für ein Minimum an Verletzungsgefahr und ein Maximum an Pflegeleichtigkeit und Belastbarkeit.

- Hohlkehlsystem
- Sockelsystem
- Radialleistensystem

Hohlkehlsystem kombiniert mit Radialleistensystem

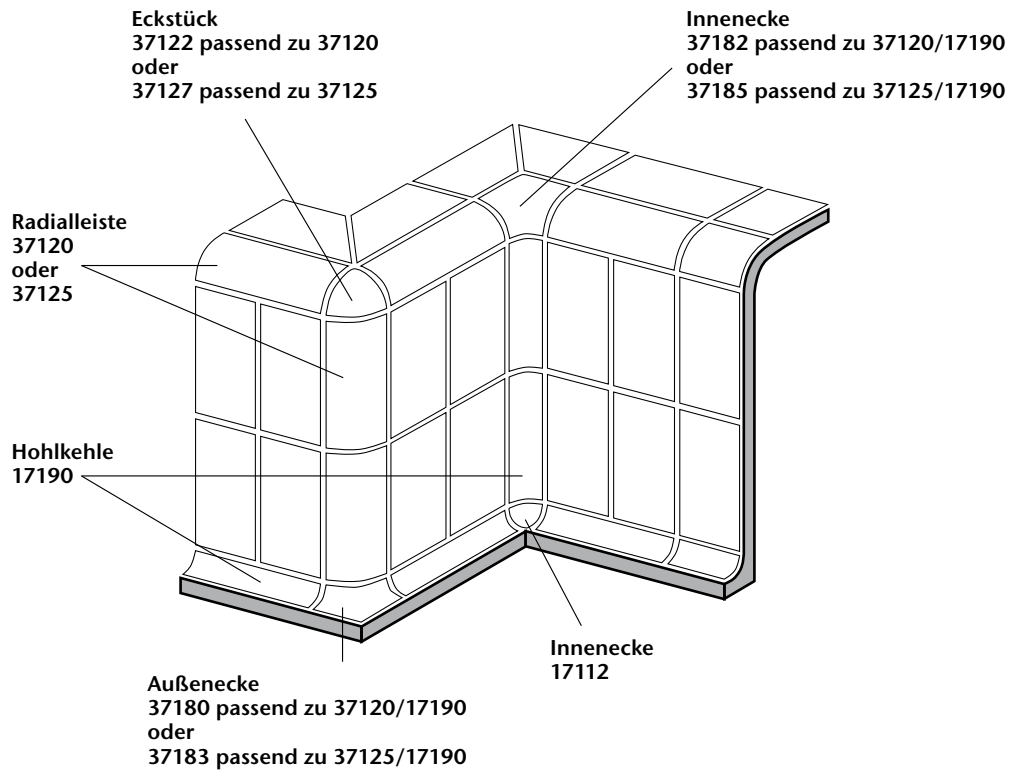

Kehlsockelsystem kombiniert mit Radialleistensystem

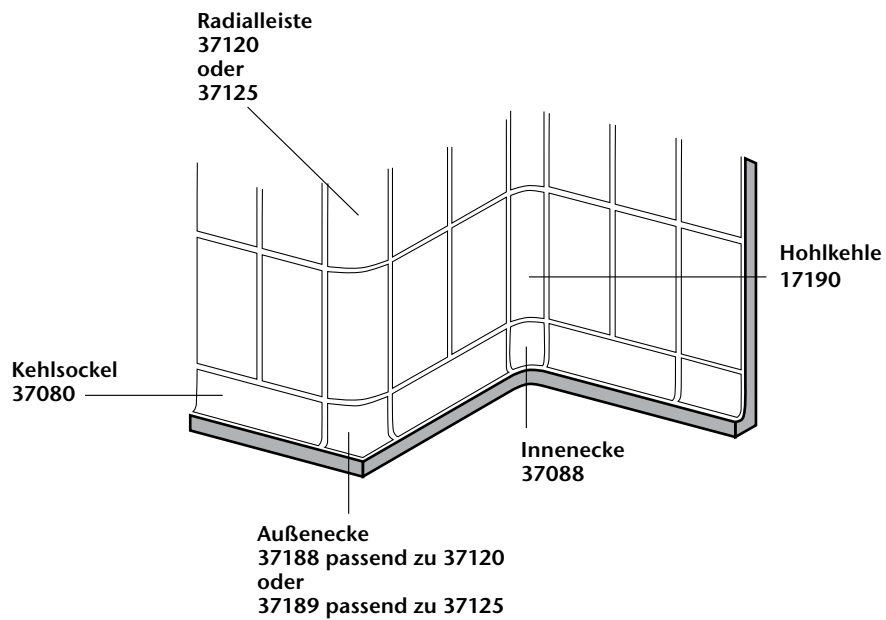

Radius 33 mm¹



Hohlkehle, r = 33 mm	Hohlkehle „halbe Länge“	Endkehle	Innenecke Gehrungspaar	Außenecke Gehrungspaar	Innenecke für Hohlkehlen für 3-seitigen Anschluss	Innenecke für Übergang Kehlsoclel 37080 auf Hohlkehle 17190		
17190	17193	17191	17196	17194	17112	37088		
244 x r33 x 6	119 x r33 x 6	244 x r33 x 6	244/244 x r33 x 6	127/127 x r33 x 6	33 x 33 x 33	125 x r33 x 8		Formatnummer
4,000	8,000							Nennmaß
0,300/Stück	0,140/Stück	0,300/Stück	0,550/Par	0,350/Par	0,090/Stück	0,300/Stück		Herstellmaß mm
54 Stück	108 Stück	54 Stück	27 Paar	24 Paar				m - Stück
13,500	13,500							St./Paar - kg
16,200	15,120	16,200	14,850	8,400				Paket - St./Paar
								Paket - m
								Paket - kg
								Palette - m
								Palette - kg
Alb	Alb	Alb	Alb	Alb	Alb	Alb		Produktnorm
700-17190	700-17193	700-17191	700-17196	700-17194	700-17112	700-37088	4	neutral 10
Preisgr. A423 (St.)	Preisgr. A413 (St.)	Preisgr. A425 (St.)	Preisgr. A471 (Paar)	Preisgr. A471 (Paar)	Preisgr. A434 (St.)	Preisgr. A480 (St.)		(aktivweiß glzd.)
701-17190	701-17193	701-17191	701-17196	701-17194	701-17112	701-37088	4	neutral 10
Preisgr. A423 (St.)	Preisgr. A413 (St.)	Preisgr. A425 (St.)	Preisgr. A471 (Paar)	Preisgr. A471 (Paar)	Preisgr. A434 (St.)	Preisgr. A480 (St.)		(aktivweiß matt)
552001-17190	552001-17193	552001-17191	552001-17196	552001-17194	552001-17112	552001-37088	2	azur aktiv
Preisgr. A425 (St.)	Preisgr. A416 (St.)	Preisgr. A428 (St.)	Preisgr. A474 (Paar)	Preisgr. A474 (Paar)	Preisgr. A438 (St.)	Preisgr. A484 (St.)		
552002-17190	552002-17193	552002-17191	552002-17196	552002-17194	552002-17112	552002-37088	4	azur hell
Preisgr. A425 (St.)	Preisgr. A416 (St.)	Preisgr. A428 (St.)	Preisgr. A474 (Paar)	Preisgr. A474 (Paar)	Preisgr. A438 (St.)	Preisgr. A484 (St.)		
5716-17190³	5716-17193³	5716-17191³	5716-17196³	5716-17194³	5716-17112³	5716-37088³	1	neutral 1
Preisgr. A425 (St.)	Preisgr. A416 (St.)	Preisgr. A428 (St.)	Preisgr. A474 (Paar)	Preisgr. A474 (Paar)	Preisgr. A438 (St.)	Preisgr. A484 (St.)		(tiefschwarz)
900-17190²	900-17193²	900-17191²	900-17196²	900-17194²	900-17112²	900-37088²		graubeige
Preisgr. A428 (St.)	Preisgr. A416 (St.)	Preisgr. A434 (St.)	Preisgr. A487 (Paar)	Preisgr. A487 (Paar)	Preisgr. A442 (St.)	Preisgr. A480 (St.)		

¹ System auf Wunsch auch in 294 mm Länge lieferbar



Radius 60 mm



Hohlkehle, r = 60 mm	Hohlkehle „halbe Länge“	Endkehle	Innenecke Gehrungspaar	Außenecke Gehrungspaar	Innenecke für Hohlkehlen für 3-seitigen Anschluss	Außenecke für Übergang Hohlkehle 18190 auf Radialleiste 37125		
18190	18193	18191	18196	18194	18192	37186		
244 x r60 x 8	119 x r60 x 8	244 x r60 x 8	244/244 x r60 x 8	127/127 x r60 x 8	60 x 60 x 60			Formatnummer
4,000	8,000							Nennmaß
0,700/Stück	0,340/Stück	0,700/Stück	1,300/Par	0,850/Par	0,100/Stück	0,350/Stück		Herstellmaß mm
18 Stück	36 Stück	18 Stück	9 Paar	7 Paar				m - Stück
4,500	4,500							St./Paar - kg
12,600	12,240	12,600	11,700	5,950				Paket - St./Paar
								Paket - m
								Paket - kg
								Palette - m
								Palette - kg
Alb	Alb	Alb	Alb	Alb	Alb	Alb		Produktnorm
700-18190	700-18193	700-18191	700-18196	700-18194	700-18192	700-37186	4	neutral 10
Preisgr. A458 (St.)	Preisgr. A438 (St.)	Preisgr. A471 (St.)	Preisgr. A506 (Paar)	Preisgr. A506 (Paar)	Preisgr. A449 (St.)	Preisgr. A528 (St.)		(aktivweiß glzd.)
701-18190	701-18193	701-18191	701-18196	701-18194	701-18192	701-37186	4	neutral 10
Preisgr. A458 (St.)	Preisgr. A438 (St.)	Preisgr. A471 (St.)	Preisgr. A506 (Paar)	Preisgr. A506 (Paar)	Preisgr. A449 (St.)	Preisgr. A528 (St.)		(aktivweiß matt)
552001-18190	552001-18193	552001-18191	552001-18196	552001-18194	552001-18192	552001-37186	2	azur aktiv
Preisgr. A463 (St.)	Preisgr. A441 (St.)	Preisgr. A474 (St.)	Preisgr. A511 (Paar)	Preisgr. A511 (Paar)	Preisgr. A452 (St.)	Preisgr. A539 (St.)		
552002-18190	552002-18193	552002-18191	552002-18196	552002-18194	552002-18192	552002-37186	4	azur hell
Preisgr. A463 (St.)	Preisgr. A441 (St.)	Preisgr. A474 (St.)	Preisgr. A511 (Paar)	Preisgr. A511 (Paar)	Preisgr. A452 (St.)	Preisgr. A539 (St.)		
5716-18190³	5716-18193³	5716-18191³	5716-18196³	5716-18194³	5716-18192³	5716-37186³	1	neutral 1
Preisgr. A463 (St.)	Preisgr. A441 (St.)	Preisgr. A474 (St.)	Preisgr. A511 (Paar)	Preisgr. A511 (Paar)	Preisgr. A452 (St.)	Preisgr. A539 (St.)		(tiefschwarz)
900-18190²	900-18193²	900-18191²	900-18196²	900-18194²	900-18192²	900-37186²		graubeige
Preisgr. A467 (St.)	Preisgr. A445 (St.)	Preisgr. A480 (St.)	Preisgr. A519 (Paar)	Preisgr. A519 (Paar)	Preisgr. A455 (St.)	Preisgr. A545 (St.)		

²  Auftragsfertigung: Rückgabe und/oder Stornierung bestellter Ware nicht möglich.

³ Produktionsbedingt können Farbunterschiede zwischen Formstücken und Flächenware auftreten.



 Die dargestellten Produkte können auch in anderen Farben der Serie Chroma gefertigt werden. Gerne prüfen wir die Möglichkeit einer solchen Sonderproduktion im Einzelfall.

Kehlsockelsystem

25 x 6,6 cm



25 x 12,5 cm



	Berlinsocket	Außenecke	Innenecke	Kehlsocket, r = 12 mm	Außenecke Gehrungspaar	Innenecke Gehrungspaar	
Formatnummer	37090	37091	37092	37080	37081	37082	
Nennmaß - cm/in	25 x 6,6 / 10 x 2 5/8			25 x 12,5 / 10 x 5			
Herstellmaß mm	244 x 60/8 x 6	(2x) 35 x 60/8 x 6	(2x) 25 x 60/8 x 6	244 x 125/12 x 8	(2x) 131 x 125/12 x 8	(2x) 119 x 125/12 x 8	
m - Stück	4,000			4,000			
St./Paar - kg	0,230/Stück	0,100/Stück	0,100/Stück	0,630/Stück	0,600/Paar	0,400/Paar	
Paket - St./Paar	40 Stück	72 Stück	192 Stück	20 Stück	10 Paar	10 Paar	
Paket - m	10,000			5,000			
Paket - kg	9,200	7,200	19,200	12,600	6,000	4,000	
Palette - m							
Palette - kg							
Produktnorm	Alb	Alb	Alb	Alb	Alb	Alb	
neutral 10	4			700-37080	700-37081	700-37082	
(aktivweiß glzd.)				Preisgr. A434 (St.)	Preisgr. A475 (Paar)	Preisgr. A475 (Paar)	
neutral 10	4			701-37080	701-37081	701-37082	
(aktivweiß matt)	Preisgr. A434 (St.)	Preisgr. A463 (St.)	Preisgr. A463 (St.)	Preisgr. A434 (St.)	Preisgr. A475 (Paar)	Preisgr. A475 (Paar)	



Sockelleisten

20 x 7,9 cm



25 x 7,9 cm



30 x 7,9 cm



25 x 6,2 cm



20 x 10 cm



25 x 12,5 cm



	44025	34020	44026	37024	37023	37021	
Nennmaß - cm/in	20 x 7,9 / 8 x 3 1/8	25 x 7,9 / 10 x 3 1/8	30 x 7,9 / 12 x 3 1/8	25 x 6,2 / 10 x 2 1/2	20 x 10 / 8 x 4	25 x 12,5 / 10 x 5	
Herstellmaß mm	194 x 73 x 8	244 x 73 x 8	294 x 73 x 8	244 x 56/56 x 8	194 x 94/56 x 8	244 x 119/56 x 8	
m - Stück	5,000	4,000	3,333	4,000	5,000	4,000	
Stück - kg	0,240	0,290	0,360	0,440	0,510	0,730	
Paket - Stück	33	33	30	24	10	10	
Paket - m	6,600	8,250	9,000	6,000	2,000	2,500	
Paket - kg	7,920	9,570	10,800	10,560	5,100	7,300	
Palette - m							
Palette - kg							
Produktnorm	Alb	Alb	Alb	Alb	Alb	Alb	
neutral 10	4			700-37024	700-37023	700-37021	
(aktivweiß glzd.)				Preisgr. A423 (St.)	Preisgr. A434 (St.)	Preisgr. A441 (St.)	
neutral 10	4			701-37024	701-37023	701-37021	
(aktivweiß matt)	Preisgr. A410 (St.)	Preisgr. A410 (St.)	Preisgr. A411 (St.)	Preisgr. A423 (St.)	Preisgr. A434 (St.)	Preisgr. A441 (St.)	



 Die dargestellten Produkte können auch in anderen Farben der Serie Chroma gefertigt werden. Gerne prüfen wir die Möglichkeit einer solchen Sonderproduktion im Einzelfall.

Radius 30 mm



Radialleiste, r = 30 mm	„halbe“ Radialleiste	Eckstück	Außenecke für Übergang Hohlkehle 17190 auf Radialleiste 37120	Außenecke für Übergang Kehlsockel 37080 auf Radialleiste 37120	Innenecke für Übergang Hohlkehle 17190 auf Radialleiste 37120	Beanspruchungsgruppe
37120	37121	37122	37180	37188	37182	Formatnummer
244 x r30 x 8	119 x r30 x 8					Nennmaß - cm
4,000	8,000					Herstellmaß mm
0,190	0,100	0,030	0,120	0,300	0,090	m - Stück
99	198					Stück - kg
24,750	24,750					Paket - Stück
18,810	19,800					Paket - m
						Paket - kg
						Palette - m
						Palette - kg
Alb	Alb	Alb	Alb	Alb	Alb	Produktnorm
siehe unten	siehe unten	siehe unten	siehe unten	siehe unten	siehe unten	Trittsicherheit
700-37120	700-37121	700-37122	700-37180	700-37188	700-37182	4 neutral 10
Preisgr. A438 (St.)	Preisgr. A423 (St.)	Preisgr. A467 (St.)	Preisgr. A480 (St.)	Preisgr. A519 (St.)	Preisgr. A519 (St.)	(aktivweiß glzd.)
701-37120	701-37121	701-37122	701-37180	701-37188	701-37182	4 neutral 10
Preisgr. A438 (St.)	Preisgr. A423 (St.)	Preisgr. A467 (St.)	Preisgr. A480 (St.)	Preisgr. A519 (St.)	Preisgr. A519 (St.)	(aktivweiß matt)
552001-37120	552001-37121	552001-37122	552001-37180	552001-37188	552001-37182	2 azur aktiv
Preisgr. A441 (St.)	Preisgr. A425 (St.)	Preisgr. A471 (St.)	Preisgr. A484 (St.)	Preisgr. A528 (St.)	Preisgr. A528 (St.)	
552002-37120	552002-37121	552002-37122	552002-37180	552002-37188	552002-37182	4 azur hell
Preisgr. A441 (St.)	Preisgr. A425 (St.)	Preisgr. A471 (St.)	Preisgr. A484 (St.)	Preisgr. A528 (St.)	Preisgr. A528 (St.)	
5716-37120²	5716-37121²	5716-37122²	5716-37180²	5716-37188²	5716-37182²	1 neutral 1
Preisgr. A441 (St.)	Preisgr. A425 (St.)	Preisgr. A471 (St.)	Preisgr. A484 (St.)	Preisgr. A528 (St.)	Preisgr. A528 (St.)	(tiefschwarz)
-/B	-/B	-/B	-/B	-/B	-/B	
91-37120	91-37121	91-37122	91-37180	91-37188	91-37182	neutral 10
Preisgr. A445 (St.)	Preisgr. A428 (St.)	Preisgr. A474 (St.)	Preisgr. A489 (St.)	Preisgr. A539 (St.)	Preisgr. A539 (St.)	(aktivweiß)
-/B	-/B	-/B	-/B	-/B	-/B	
553001-37120	553001-37121	553001-37122	553001-37180	553001-37188	553001-37182	azur aktiv
Preisgr. A449 (St.)	Preisgr. A430 (St.)	Preisgr. A480 (St.)	Preisgr. A506 (St.)	Preisgr. A545 (St.)	Preisgr. A545 (St.)	
-/B	-/B	-/B	-/B	-/B	-/B	
553002-37120	553002-37121	553002-37122	553002-37180	553002-37188	553002-37182	azur hell
Preisgr. A449 (St.)	Preisgr. A430 (St.)	Preisgr. A480 (St.)	Preisgr. A506 (St.)	Preisgr. A545 (St.)	Preisgr. A545 (St.)	
-/B	-/B	-/B	-/B	-/B	-/B	
340-37120	340-37121	340-37122	340-37180	340-37188	340-37182	neutral 1
Preisgr. A449 (St.)	Preisgr. A430 (St.)	Preisgr. A480 (St.)	Preisgr. A506 (St.)	Preisgr. A545 (St.)	Preisgr. A545 (St.)	(tiefschwarz)
-/C	-/C	-/C	-/C	-/C	-/C	
81-37120	81-37121	81-37122	81-37180	81-37188	81-37182	neutral 10
Preisgr. A445 (St.)	Preisgr. A428 (St.)	Preisgr. A474 (St.)	Preisgr. A489 (St.)	Preisgr. A539 (St.)	Preisgr. A539 (St.)	(aktivweiß)
-/C	-/C	-/C	-/C	-/C	-/C	
554001-37120	554001-37121	554001-37122	554001-37180	554001-37188	554001-37182	azur aktiv
Preisgr. A449 (St.)	Preisgr. A430 (St.)	Preisgr. A480 (St.)	Preisgr. A506 (St.)	Preisgr. A545 (St.)	Preisgr. A545 (St.)	
-/C	-/C	-/C	-/C	-/C	-/C	
554002-37120	554002-37121	554002-37122	554002-37180	554002-37188	554002-37182	azur hell
Preisgr. A449 (St.)	Preisgr. A430 (St.)	Preisgr. A480 (St.)	Preisgr. A506 (St.)	Preisgr. A545 (St.)	Preisgr. A545 (St.)	
-/C	-/C	-/C	-/C	-/C	-/C	
554111-37120	554111-37121	554111-37122	554111-37180	554111-37188	554111-37182	neutral 1
Preisgr. A449 (St.)	Preisgr. A430 (St.)	Preisgr. A480 (St.)	Preisgr. A506 (St.)	Preisgr. A545 (St.)	Preisgr. A545 (St.)	(tiefschwarz)
R10/A	R10/A	R10/A	R10/A	R10/A	R10/A	
900-37120¹	900-37121¹	900-37122¹	900-37180¹	900-37188¹	900-37182¹	graubeige
Preisgr. A438 (St.)	Preisgr. A423 (St.)	Preisgr. A467 (St.)	Preisgr. A480 (St.)	Preisgr. A519 (St.)	Preisgr. A519 (St.)	

¹  Auftragsfertigung: Rückgabe und/oder Stornierung bestellter Ware nicht möglich.

² Produktionsbedingt können Farbunterschiede zwischen Formstücken und Flächenware auftreten.

 Die dargestellten Produkte können auch in anderen Farben der Serie Chroma und Chroma non-slip gefertigt werden. Gerne prüfen wir die Möglichkeit einer solchen Sonderproduktion im Einzelfall.





Radius 60 mm



Radialleiste,
r = 60 mm

„halbe“ Radialleiste

Eckstück

Außenecke für
Übergang Hohlkehle
17190 auf
Radialleiste 37125

Außenecke für
Übergang Kehlsocle
37080 auf
Radialleiste 37125

Innenecke für
Übergang Hohlkehle
17190 auf
Radialleiste 37125

Formatnummer	37125	37126	37127	37183	37189	37185
Nennmaß - cm						
Herstellmaß mm	244 x r60 x 8	119 x r60 x 8				
m - Stück	4,000	8,000				
Stück - kg	0,380	0,190	0,100	0,250	0,300	0,200
Paket - Stück	24	48				
Paket - m	6,000	6,000				
Palette - kg	9,120	9,120				
Produktnorm	Alb	Alb	Alb	Alb	Alb	Alb
Trittsicherheit	siehe unten	siehe unten	siehe unten	siehe unten	siehe unten	siehe unten
neutral 10 (aktivweiß glzd.)	4 700-37125 Preisgr. A467 (St.)	700-37126 Preisgr. A438 (St.)	700-37127 Preisgr. A511 (St.)	700-37183 Preisgr. A511 (St.)	700-37189 Preisgr. A533 (St.)	700-37185 Preisgr. A533 (St.)
neutral 10 (aktivweiß matt)	4 701-37125 Preisgr. A467 (St.)	701-37126 Preisgr. A438 (St.)	701-37127 Preisgr. A511 (St.)	701-37183 Preisgr. A511 (St.)	701-37189 Preisgr. A533 (St.)	701-37185 Preisgr. A533 (St.)
azur aktiv	2 552001-37125 Preisgr. A471 (St.)	552001-37126 Preisgr. A441 (St.)	552001-37127 Preisgr. A519 (St.)	552001-37183 Preisgr. A519 (St.)	552001-37189 Preisgr. A545 (St.)	552001-37185 Preisgr. A545 (St.)
azur hell	4 552002-37125 Preisgr. A471 (St.)	552002-37126 Preisgr. A441 (St.)	552002-37127 Preisgr. A519 (St.)	552002-37183 Preisgr. A519 (St.)	552002-37189 Preisgr. A545 (St.)	552002-37185 Preisgr. A545 (St.)
neutral 1 (tiefschwarz)	1 5716-37125² Preisgr. A471 (St.)	5716-37126² Preisgr. A441 (St.)	5716-37127² Preisgr. A519 (St.)	5716-37183² Preisgr. A519 (St.)	5716-37189² Preisgr. A545 (St.)	5716-37185² Preisgr. A545 (St.)
neutral 10 (aktivweiß)	-/B 91-37125 Preisgr. A474 (St.)	-/B 91-37126 Preisgr. A445 (St.)	-/B 91-37127 Preisgr. A528 (St.)	-/B 91-37183 Preisgr. A528 (St.)	-/B 91-37189 Preisgr. A556 (St.)	-/B 91-37185 Preisgr. A556 (St.)
azur aktiv	-/B 553001-37125 Preisgr. A480 (St.)	-/B 553001-37126 Preisgr. A449 (St.)	-/B 553001-37127 Preisgr. A539 (St.)	-/B 553001-37183 Preisgr. A539 (St.)	-/B 553001-37189 Preisgr. A573 (St.)	-/B 553001-37185 Preisgr. A573 (St.)
azur hell	-/B 553002-37125 Preisgr. A480 (St.)	-/B 553002-37126 Preisgr. A449 (St.)	-/B 553002-37127 Preisgr. A539 (St.)	-/B 553002-37183 Preisgr. A539 (St.)	-/B 553002-37189 Preisgr. A573 (St.)	-/B 553002-37185 Preisgr. A573 (St.)
neutral 1 (tiefschwarz)	-/B 340-37125 Preisgr. A480 (St.)	-/B 340-37126 Preisgr. A449 (St.)	-/B 340-37127 Preisgr. A539 (St.)	-/B 340-37183 Preisgr. A539 (St.)	-/B 340-37189 Preisgr. A573 (St.)	-/B 340-37185 Preisgr. A573 (St.)
neutral 10 (aktivweiß)	-/C 81-37125 Preisgr. A474 (St.)	-/C 81-37126 Preisgr. A445 (St.)	-/C 81-37127 Preisgr. A528 (St.)	-/C 81-37183 Preisgr. A528 (St.)	-/C 81-37189 Preisgr. A556 (St.)	-/C 81-37185 Preisgr. A556 (St.)
azur aktiv	-/C 554001-37125 Preisgr. A480 (St.)	-/C 554001-37126 Preisgr. A449 (St.)	-/C 554001-37127 Preisgr. A539 (St.)	-/C 554001-37183 Preisgr. A539 (St.)	-/C 554001-37189 Preisgr. A573 (St.)	-/C 554001-37185 Preisgr. A573 (St.)
azur hell	-/C 554002-37125 Preisgr. A480 (St.)	-/C 554002-37126 Preisgr. A449 (St.)	-/C 554002-37127 Preisgr. A539 (St.)	-/C 554002-37183 Preisgr. A539 (St.)	-/C 554002-37189 Preisgr. A573 (St.)	-/C 554002-37185 Preisgr. A573 (St.)
neutral 1 (tiefschwarz)	-/C 554111-37125 Preisgr. A480 (St.)	-/C 554111-37126 Preisgr. A449 (St.)	-/C 554111-37127 Preisgr. A539 (St.)	-/C 554111-37183 Preisgr. A539 (St.)	-/C 554111-37189 Preisgr. A573 (St.)	-/C 554111-37185 Preisgr. A573 (St.)
graubeige	R10/A 900-37125¹ Preisgr. A467 (St.)	R10/A 900-37126¹ Preisgr. A438 (St.)	R10/A 900-37127¹ Preisgr. A511 (St.)	R10/A 900-37183¹ Preisgr. A511 (St.)	R10/A 900-37189¹ Preisgr. A533 (St.)	R10/A 900-37185¹ Preisgr. A533 (St.)

¹ Auftragsfertigung: Rückgabe und/oder Stornierung bestellter Ware nicht möglich.

² Produktionsbedingt können Farbunterschiede zwischen Formstücken und Flächenware auftreten.

Die dargestellten Produkte können auch in anderen Farben der Serie Chroma und Chroma non-slip gefertigt werden. Gerne prüfen wir die Möglichkeit einer solchen Sonderproduktion im Einzelfall.

Projekt: Ägeribad / Architekt: Scheitlin Syfrig Architekten AG / Serie: Chroma,
Chroma unglasiert - Quantum, Loop, Plural, non-slip / Foto: Adriano Faragulo



Projekt: Freizeitbad / Standort: Baesweiler, Deutschland / Architekt: Planteam Ruhr /
Serie: Beckenkopfsystem Wiesbaden, Valley / Foto: Jochen Stüber





Für sicheren Tritt

Rillenplatten finden vor allem an jenen Stellen Verwendung, an denen für Schwimmbadbesucher ein erhöhtes Risiko besteht, zu stürzen. Ihre gerillte, besonders rutschhemmende Oberfläche bietet z. B. an Treppenkanten guten Halt und verhindert das Abrutschen. Dabei senden sie schon durch ihre Haptik und meist kontrastive Farbe ein deutliches Signal an den Nutzer: hier gilt es aufzupassen! Wasserführende oder dauerhaft nassbelastete Treppen und die Markierung von Kanten sind typische Einsatzorte für Rillenplatten. Sie eignen sich aber ebenso für haptische und optische Begrenzungen oder als Leitsysteme für Badegäste mit Sehbehinderung.

8 mm stark, z. B. für ins Wasser führende Treppen und sonstige nassbelastete Treppen in Schwimmhallen

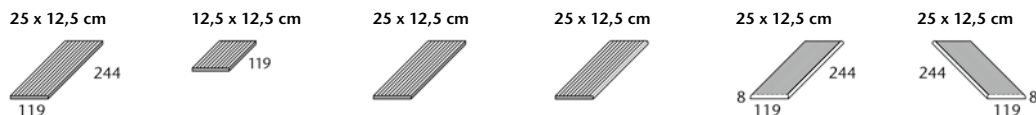

	gerillt	„halbe“ Platte, gerillt	gerillt, Kopfkante gerundet	gerillt, Längskante gerundet	gerillt, Ecke links gerundet	gerillt, Ecke rechts gerundet
Formatnummer	34100	34109	34105	34106	34107	34108
Nennmaß - cm/in	25 x 12,5 / 10 x 5	12,5 x 12,5 / 5 x 5	25 x 12,5 / 10 x 5	25 x 12,5 / 10 x 5	25 x 12,5 / 10 x 5	25 x 12,5 / 10 x 5
Herstellmaß	244 x 119 x 8 mm	119 x 119 x 8 mm	244 x 119 x 8 mm	244 x 119 x 8 mm	244 x 119 x 8 mm	244 x 119 x 8 mm
m - Stück	4,000	8,000	4,000	4,000	4,000	4,000
Stück - kg	0,460	0,230	0,460	0,460	0,460	0,460
Paket - Stück	33	66	33	33	33	33
Paket - m	8,250	8,250	8,250	8,250	8,250	8,250
Paket - kg	15,180	15,180	15,180	15,180	15,180	15,180
Palette - m						
Palette - kg						
Produktnorm	Alb	Alb	Alb	Alb	Alb	Alb
Trittsicherheit	-/C	-/C	-/C	-/C	-/C	-/C
graubeige	900-34100 Preisgr. A410 (St.)	900-34109 Preisgr. A406 (St.)	900-34105 Preisgr. A413 (St.)	900-34106 Preisgr. A413 (St.)	900-34107 Preisgr. A418 (St.)	900-34108 Preisgr. A418 (St.)
neutral 10 (aktivweiß)	91i-34100H¹ ☒ Preisgr. A423 (St.)	91i-34109H¹ ☒ Preisgr. A413 (St.)	91i-34105H¹ ☒ Preisgr. A434 (St.)	91i-34106H¹ ☒ Preisgr. A434 (St.)	91i-34107H¹ ☒ Preisgr. A445 (St.)	91i-34108H¹ ☒ Preisgr. A445 (St.)



¹ mit Hytect

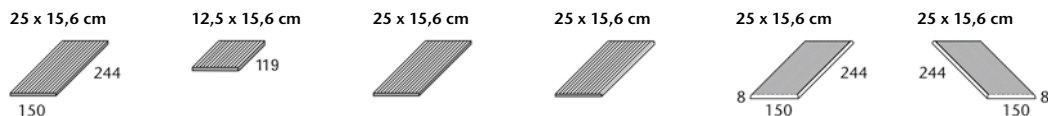

	gerillt	„halbe“ Platte, gerillt	gerillt, Kopfkante gerundet	gerillt, Längskante gerundet	gerillt, Ecke links gerundet	gerillt, Ecke rechts gerundet
Formatnummer	34110	34119	34115	34116	34117	34118
Nennmaß - cm/in	25 x 15,6 / 10 x 6 1/4	12,5 x 15,6 / 5 x 6 1/4	25 x 15,6 / 10 x 6 1/4	25 x 15,6 / 10 x 6 1/4	25 x 15,6 / 10 x 6 1/4	25 x 15,6 / 10 x 6 1/4
Herstellmaß	244 x 150 x 8 mm	119 x 150 x 8 mm	244 x 150 x 8 mm	244 x 150 x 8 mm	244 x 150 x 8 mm	244 x 150 x 8 mm
m - Stück	4,000	8,000	4,000	4,000	4,000	4,000
Stück - kg	0,580	0,280	0,580	0,580	0,580	0,580
Paket - Stück	33	66	33	33	33	33
Paket - m	8,250	8,250	8,250	8,250	8,250	8,250
Paket - kg	19,140	18,480	19,140	19,140	19,140	19,140
Palette - m						
Palette - kg						
Produktnorm	Alb	Alb	Alb	Alb	Alb	Alb
Trittsicherheit	-/C	-/C	-/C	-/C	-/C	-/C
graubeige	900-34110 Preisgr. A425 (St.)	900-34119 Preisgr. A413 (St.)	900-34115 Preisgr. A434 (St.)	900-34116 Preisgr. A434 (St.)	900-34117 Preisgr. A445 (St.)	900-34118 Preisgr. A445 (St.)
neutral 10 (aktivweiß)	91i-34110H¹ ☒ Preisgr. A452 (St.)	91i-34119H¹ ☒ Preisgr. A434 (St.)	91i-34115H¹ ☒ Preisgr. A475 (St.)	91i-34116H¹ ☒ Preisgr. A475 (St.)	91i-34117H¹ ☒ Preisgr. A506 (St.)	91i-34118H¹ ☒ Preisgr. A506 (St.)



¹ mit Hytect

Für die auf dieser Seite gezeigten Produkte wird kein Palettenrabatt gewährt.

Die dargestellten Produkte können auch in anderen Farben der Serie Chroma non-slip gefertigt werden. Gerne prüfen wir die Möglichkeit einer solchen Sonderproduktion im Einzelfall.

Gerundete Ecken			gerundete Ecken	Beispiel: Grundformat-Nr. 34100 = 244 x 119 x 8 mm, Format-Nr. 34107 = gerundete Ecke links
Grundformat-Nr. statt Endziffer 0 Endziffer 7 = Ecke links	... 8 = Ecke rechts	gerundete Ecken	

8 mm stark. Mit non-slip-Sicherheitsmarkierung

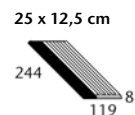
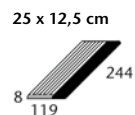
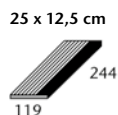

gerillt,
Längskante gerundet

„halbe“ Platte gerillt,
Längskante gerundet

gerillt,
Ecke links gerundet

gerillt,
Ecke rechts gerundet



34146H	34149H	34147H	34148H	Formatnummer
25 x 12,5 / 10 x 5	12,5 x 12,5 / 5 x 5	25 x 12,5 / 10 x 5	25 x 12,5 / 10 x 5	Nennmaß - cm/in
244 x 119 x 8 mm	119 x 119 x 8 mm	244 x 119 x 8 mm	244 x 119 x 8 mm	Herstellmaß
4,000	8,000	4,000	4,000	m - Stück
0,460	0,230	0,460	0,460	Stück - kg
33	66	33	33	Paket - Stück
8,250	8,250	8,250	8,250	Paket - m
15,180	15,180	15,180	15,180	Paket - kg
				Palette - m
				Palette - kg
Alb	Alb	Alb	Alb	Produktnorm
-/C	-/C	-/C	-/C	Trittsicherheit
553001-34146H	553001-34149H	553001-34147H	553001-34148H	900 graubeige
Preisgr. A423 (St.)	Preisgr. A413 (St.)	Preisgr. A430 (St.)	Preisgr. A430 (St.)	553001 azur aktiv
553002-34146H	553002-34149H	553002-34147H	553002-34148H	900 graubeige
Preisgr. A423 (St.)	Preisgr. A413 (St.)	Preisgr. A430 (St.)	Preisgr. A430 (St.)	553002 azur hell
340i-34146H	340i-34149H	340i-34147H	340i-34148H	900 graubeige
Preisgr. A423 (St.)	Preisgr. A413 (St.)	Preisgr. A430 (St.)	Preisgr. A430 (St.)	340 n1/schwarz
900567-34146H	900567-34149H	900567-34147H	900567-34148H	91 n10/weiß
Preisgr. A445 (St.)	Preisgr. A434 (St.)	Preisgr. A456 (St.)	Preisgr. A456 (St.)	553001 azur aktiv
900588-34146H	900588-34149H	900588-34147H	900588-34148H	91 n10/weiß
Preisgr. A445 (St.)	Preisgr. A434 (St.)	Preisgr. A456 (St.)	Preisgr. A456 (St.)	553002 azur hell
900044-34146H	900044-34149H	900044-34147H	900044-34148H	91 n10/weiß
Preisgr. A445 (St.)	Preisgr. A434 (St.)	Preisgr. A456 (St.)	Preisgr. A456 (St.)	340 n1/schwarz

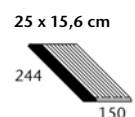
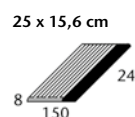
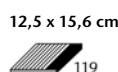
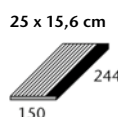

gerillt,
Längskante gerundet

„halbe“ Platte gerillt,
Längskante gerundet

gerillt,
Ecke links gerundet

gerillt,
Ecke rechts gerundet



34156H	34159H	34157H	34158H	Formatnummer
25 x 15,6 / 10 x 6 1/4	12,5 x 15,6 / 5 x 6 1/4	25 x 15,6 / 10 x 6 1/4	25 x 15,6 / 10 x 6 1/4	Nennmaß - cm/in
244 x 150 x 8 mm	119 x 150 x 8 mm	244 x 150 x 8 mm	244 x 150 x 8 mm	Herstellmaß
4,000	8,000	4,000	4,000	m - Stück
0,580	0,280	0,580	0,580	Stück - kg
33	66	33	33	Paket - Stück
8,250	8,250	8,250	8,250	Paket - m
19,140	18,480	19,140	19,140	Paket - kg
				Palette - m
				Palette - kg
Alb	Alb	Alb	Alb	Produktnorm
-/C	-/C	-/C	-/C	Trittsicherheit
553001-34156H	553001-34159H	553001-34157H	553001-34158H	900 graubeige
Preisgr. A438 (St.)	Preisgr. A423 (St.)	Preisgr. A449 (St.)	Preisgr. A449 (St.)	553001 azur aktiv
553002-34156H	553002-34159H	553002-34157H	553002-34158H	900 graubeige
Preisgr. A438 (St.)	Preisgr. A423 (St.)	Preisgr. A449 (St.)	Preisgr. A449 (St.)	553002 azur hell
340i-34156H	340i-34159H	340i-34157H	340i-34158H	900 graubeige
Preisgr. A438 (St.)	Preisgr. A423 (St.)	Preisgr. A449 (St.)	Preisgr. A449 (St.)	340 n1/schwarz
900567-34156H	900567-34159H	900567-34157H	900567-34158H	91 n10/weiß
Preisgr. A480 (St.)	Preisgr. A445 (St.)	Preisgr. A506 (St.)	Preisgr. A506 (St.)	553001 azur aktiv
900588-34156H	900588-34159H	900588-34157H	900588-34158H	91 n10/weiß
Preisgr. A480 (St.)	Preisgr. A445 (St.)	Preisgr. A506 (St.)	Preisgr. A506 (St.)	553002 azur hell
900044-34156H	900044-34159H	900044-34157H	900044-34158H	91 n10/weiß
Preisgr. A480 (St.)	Preisgr. A445 (St.)	Preisgr. A506 (St.)	Preisgr. A506 (St.)	340 n1/schwarz



Die dargestellten Produkte können auch in anderen Farben der Serie Chroma non-slip gefertigt werden. Gerne prüfen wir die Möglichkeit einer solchen Sonderproduktion im Einzelfall.

Für die auf dieser Seite gezeigten Produkte wird kein Palettenrabatt gewährt.

Gerundete Ecken	... 7 = Ecke links	... 8 = Ecke rechts	gerundete Ecken	Beispiel: Grundformat-Nr. 34146 = 119 x 244 x 8 mm, Format-Nr. 34147 = gerundete Ecke links

15 mm stark, z. B. zur Fortführung des Beckenrandsystems „Finland“, für Startblöcke etc.

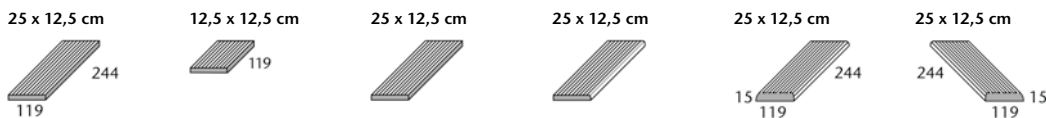

	gerillt	„halbe“ Platte, gerillt	gerillt, Kopfkante gerundet	gerillt, Längskante gerundet	gerillt, Ecke links gerundet	gerillt, Ecke rechts gerundet
Formatnummer	53130	53139	53135	53136	53137	53138
Nennmaß - cm/in	25 x 12,5 / 10 x 5	12,5 x 12,5 / 5 x 5	25 x 12,5 / 10 x 5	25 x 12,5 / 10 x 5	25 x 12,5 / 10 x 5	25 x 12,5 / 10 x 5
Herstellmaß	244 x 119 x 15 mm	119 x 119 x 15 mm	244 x 119 x 15 mm	244 x 119 x 15 mm	244 x 119 x 15 mm	244 x 119 x 15 mm
m - Stück	4,000	8,000	4,000	4,000	4,000	4,000
Stück - kg	0,830	0,420	0,830	0,830	0,830	0,830
Paket - Stück	16	32	16	16	16	16
Paket - m	4,000	4,000	4,000	4,000	4,000	4,000
Paket - kg	13,280	13,440	13,280	13,280	13,280	13,280
Palette - m						
Palette - kg						
Produktnorm	Alb	Alb	Alb	Alb	Alb	Alb
Trittsicherheit	-/C	-/C	-/C	-/C	-/C	-/C
graubeige	900-53130 Preisgr. A410 (St.)	900-53139 Preisgr. A406 (St.)	900-53135 Preisgr. A413 (St.)	900-53136 Preisgr. A413 (St.)	900-53137 Preisgr. A418 (St.)	900-53138 Preisgr. A418 (St.)
neutral 10 (aktivweiß)	91-53130 ☒ Preisgr. A423 (St.)	91-53139 ☒ Preisgr. A413 (St.)	91-53135 ☒ Preisgr. A434 (St.)	91-53136 ☒ Preisgr. A434 (St.)	91-53137 ☒ Preisgr. A445 (St.)	91-53138 ☒ Preisgr. A445 (St.)

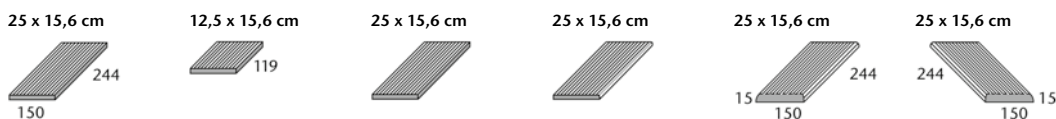

	gerillt	„halbe“ Platte, gerillt	gerillt, Kopfkante gerundet	gerillt, Längskante gerundet	gerillt, Ecke links gerundet	gerillt, Ecke rechts gerundet
Formatnummer	53190	53199	53195	53196	53197	53198
Nennmaß - cm/in	25 x 15,6 / 10 x 6 1/4	12,5 x 15,6 / 5 x 6 1/4	25 x 15,6 / 10 x 6 1/4	25 x 15,6 / 10 x 6 1/4	25 x 15,6 / 10 x 6 1/4	25 x 15,6 / 10 x 6 1/4
Herstellmaß	244 x 150 x 15 mm	119 x 150 x 15 mm	244 x 150 x 15 mm	244 x 150 x 15 mm	244 x 150 x 15 mm	244 x 150 x 15 mm
m - Stück	4,000	8,000	4,000	4,000	4,000	4,000
Stück - kg	1,000	0,490	1,000	1,000	1,000	1,000
Paket - Stück	18	36	18	18	18	18
Paket - m	4,500	4,500	4,500	4,500	4,500	4,500
Paket - kg	18,000	17,640	18,000	18,000	18,000	18,000
Palette - m						
Palette - kg						
Produktnorm	Alb	Alb	Alb	Alb	Alb	Alb
Trittsicherheit	-/C	-/C	-/C	-/C	-/C	-/C
graubeige	900-53190 Preisgr. A425 (St.)	900-53199 Preisgr. A413 (St.)	900-53195 Preisgr. A434 (St.)	900-53196 Preisgr. A434 (St.)	900-53197 Preisgr. A445 (St.)	900-53198 Preisgr. A445 (St.)
neutral 10 (aktivweiß)	91-53190 ☒ Preisgr. A452 (St.)	91-53199 ☒ Preisgr. A434 (St.)	91-53195 ☒ Preisgr. A475 (St.)	91-53196 ☒ Preisgr. A475 (St.)	91-53197 ☒ Preisgr. A506 (St.)	91-53198 ☒ Preisgr. A506 (St.)



Für die auf dieser Seite gezeigten Produkte wird kein Palettenrabatt gewährt.

Die dargestellten Produkte können auch in anderen Farben der Serie Chroma non-slip gefertigt werden. Gerne prüfen wir die Möglichkeit einer solchen Sonderproduktion im Einzelfall.

Gerundete Ecken			gerundete Ecken	Beispiel: Grundformat-Nr. 53130 = 119 x 244 x 15 mm, Format-Nr. 53137 = gerundete Ecke links
Grundformat-Nr. statt Endziffer 0 Endziffer 7 = Ecke links	... 8 = Ecke rechts	gerundete Ecken	

15 mm stark. Mit non-slip-Sicherheitsmarkierung

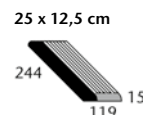
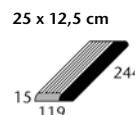
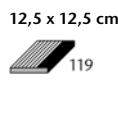
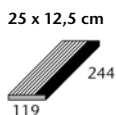

gerillt
Längskante gerundet

„halbe“ Platte gerillt,
Längskante gerundet

gerillt
Ecke links gerundet

gerillt
Ecke rechts gerundet

59620	59629	59627	59628	Formatnummer
25 x 12,5 / 10 x 5	12,5 x 12,5 / 5 x 5	25 x 12,5 / 10 x 5	25 x 12,5 / 10 x 5	Nennmaß - cm/in
244 x 119 x 15 mm	119 x 119 x 15 mm	244 x 119 x 15 mm	244 x 119 x 15 mm	Herstellmaß
4,000	8,000	4,000	4,000	m - Stück
0,830	0,420	0,830	0,830	Stück - kg
16	32	16	16	Paket - Stück
4,000	4,000	4,000	4,000	Paket - m
13,280	13,440	13,280	13,280	Paket - kg
				PaLETTE - m
				PaLETTE - kg
Alb	Alb	Alb	Alb	Produktnorm
-/C	-/C	-/C	-/C	Trittsicherheit
553001-59620	553001-59629	553001-59627	553001-59628	900 graubeige
Preisgr. A423 (St.)	Preisgr. A413 (St.)	Preisgr. A430 (St.)	Preisgr. A430 (St.)	553001 azur aktiv
553002-59620	553002-59629	553002-59627	553002-59628	900 graubeige
Preisgr. A423 (St.)	Preisgr. A413 (St.)	Preisgr. A430 (St.)	Preisgr. A430 (St.)	553002 azur hell
340-59620	340-59629	340-59627	340-59628	900 graubeige
Preisgr. A423 (St.)	Preisgr. A413 (St.)	Preisgr. A430 (St.)	Preisgr. A430 (St.)	340 n1/schwarz
900567-59620	900567-59629	900567-59627	900567-59628	91 n10/weiß
Preisgr. A445 (St.)	Preisgr. A434 (St.)	Preisgr. A456 (St.)	Preisgr. A456 (St.)	553001 azur aktiv
900588-59620	900588-59629	900588-59627	900588-59628	91 n10/weiß
Preisgr. A445 (St.)	Preisgr. A434 (St.)	Preisgr. A456 (St.)	Preisgr. A456 (St.)	553002 azur hell
900044-59620	900044-59629	900044-59627	900044-59628	91 n10/weiß
Preisgr. A445 (St.)	Preisgr. A434 (St.)	Preisgr. A456 (St.)	Preisgr. A456 (St.)	340 n1/schwarz

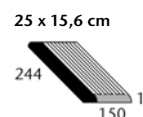
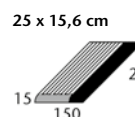
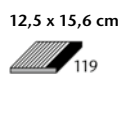
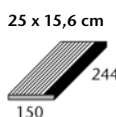

gerillt
Längskante gerundet

„halbe“ Platte gerillt,
Längskante gerundet

gerillt
Ecke links gerundet

gerillt
Ecke rechts gerundet

59630	59639	59637	59638	Formatnummer
25 x 15,6 / 10 x 6 1/4	12,5 x 15,6 / 5 x 6 1/4	25 x 15,6 / 10 x 6 1/4	25 x 15,6 / 10 x 6 1/4	Nennmaß - cm/in
244 x 150 x 15 mm	119 x 150 x 15 mm	244 x 150 x 15 mm	244 x 150 x 15 mm	Herstellmaß
4,000	8,000	4,000	4,000	m - Stück
1,000	0,490	1,000	1,000	Stück - kg
18	36	18	18	Paket - Stück
4,500	4,500	4,500	4,500	Paket - m
18,000	17,640	18,000	18,000	Paket - kg
				PaLETTE - m
				PaLETTE - kg
Alb	Alb	Alb	Alb	Produktnorm
-/C	-/C	-/C	-/C	Trittsicherheit
553001-59630	553001-59639	553001-59637	553001-59638	900 graubeige
Preisgr. A438 (St.)	Preisgr. A423 (St.)	Preisgr. A449 (St.)	Preisgr. A449 (St.)	553001 azur aktiv
553002-59630	553002-59639	553002-59637	553002-59638	900 graubeige
Preisgr. A438 (St.)	Preisgr. A423 (St.)	Preisgr. A449 (St.)	Preisgr. A449 (St.)	553002 azur hell
340-59630	340-59639	340-59637	340-59638	900 graubeige
Preisgr. A438 (St.)	Preisgr. A423 (St.)	Preisgr. A449 (St.)	Preisgr. A449 (St.)	340 n1/schwarz
900567-59630	900567-59639	900567-59637	900567-59638	91 n10/weiß
Preisgr. A480 (St.)	Preisgr. A445 (St.)	Preisgr. A506 (St.)	Preisgr. A506 (St.)	553001 azur aktiv
900588-59630	900588-59639	900588-59637	900588-59638	91 n10/weiß
Preisgr. A480 (St.)	Preisgr. A445 (St.)	Preisgr. A506 (St.)	Preisgr. A506 (St.)	553002 azur hell
900044-59630	900044-59639	900044-59637	900044-59638	91 n10/weiß
Preisgr. A480 (St.)	Preisgr. A445 (St.)	Preisgr. A506 (St.)	Preisgr. A506 (St.)	340 n1/schwarz

Die dargestellten Produkte können auch in anderen Farben der Serie Chroma non-slip gefertigt werden. Gerne prüfen wir die Möglichkeit einer solchen Sonderproduktion im Einzelfall.

Für die auf dieser Seite gezeigten Produkte wird kein Palettenrabatt gewährt.



Gerundete Ecken	... 7 = Ecke links	... 8 = Ecke rechts	gerundete Ecken	Beispiel: Grundformat-Nr. 59620 = 119 x 244 x 15 mm, Format-Nr. 59627 = gerundete Ecke links

Projekt: Solebad / Standort: Werne, Deutschland / Architekt: Geising + Böker GmbH /
Serie: Beckenkopfsystem Finnland, Chroma, Quarzit / Foto: Jochen Stüber



WT. 2.2



Keramische Spezialisten

Der Bau von Schwimmbädern bedarf einiger sehr spezieller Lösungen, die man in keinem anderen Anwendungsbereich einsetzen kann und die ein Premi-
umanbieter von Schwimmbadkeramik im Sortiment haben sollte, um mit einem ganzheitlichen Programm das volle Spektrum an Anforderungen der Bäderarchitektur abdecken zu können. Dazu gehören Sprossensteine für Beckenleitern, Schriftplatten zur Angabe von Beckentiefen oder zur Markierung von Nichtschwimmerbereichen oder Flachrinnen zur Entwässerung von Flächen. Alles Details, die sich in nahezu jedem Schwimmbad finden und die ansonsten nur durch einen Materialwechsel, z. B. auf Edelstahl, umzusetzen wären.

Treppenplatten mit non-slip-Sicherheitsmarkierung

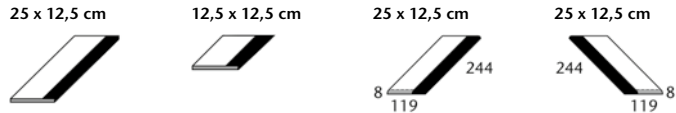

Treppenauftritt, Längskante gerundet
 „halber“ Treppenauftritt, Längskante gerundet
 Treppenauftritt, Ecke links gerundet
 Treppenauftritt, Ecke rechts gerundet

Formatnummer
Nennmaß - cm/in
Herstellmaß
m - Stück
Stück - kg
Paket - Stück
Paket - m
Paket - kg
Palette - m
Palette - kg
Produktnorm
Trittsicherheit
81 n10/weiß
554001 azur aktiv
81 n10/weiß
554002 azur hell
81 n10/weiß
554111 n1/schwarz

34166H	34169H	34167H	34168H			
25 x 12,5 / 10 x 5	12,5 x 12,5 / 5 x 5	25 x 12,5 / 10 x 5	25 x 12,5 / 10 x 5			
244 x 119 x 8 mm	119 x 119 x 8 mm	244 x 119 x 8 mm	244 x 119 x 8 mm			
4,000	8,000	4,000	4,000			
0,490	0,240	0,490	0,490			
33	66	33	33			
8,250	8,250	8,250	8,250			
16,170	15,840	16,170	16,170			
Alb	Alb	Alb	Alb			
-/C	-/C	-/C	-/C			
900568-34166H	900568-34169H	900568-34167H	900568-34168H			
Preisgr. A445 (St.)	Preisgr. A425 (St.)	Preisgr. A456 (St.)	Preisgr. A456 (St.)			
900671-34166H	900671-34169H	900671-34167H	900671-34168H			
Preisgr. A445 (St.)	Preisgr. A425 (St.)	Preisgr. A456 (St.)	Preisgr. A456 (St.)			
900634-34166H	900634-34169H	900634-34167H	900634-34168H			
Preisgr. A445 (St.)	Preisgr. A425 (St.)	Preisgr. A456 (St.)	Preisgr. A456 (St.)			



Treppenplatten mit non-slip-Sicherheitsmarkierung

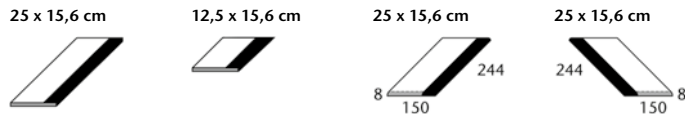

Treppenauftritt, Längskante gerundet
 „halber“ Treppenauftritt, Längskante gerundet
 Treppenauftritt, Ecke links gerundet
 Treppenauftritt, Ecke rechts gerundet

Formatnummer
Nennmaß - cm/in
Herstellmaß
m - Stück
Stück - kg
Paket - Stück
Paket - m
Paket - kg
Palette - m
Palette - kg
Produktnorm
Trittsicherheit
81 n10/weiß
554001 azur aktiv
81 n10/weiß
554002 azur hell
81 n10/weiß
554111 n1/schwarz

34136H	34139H	34137H	34138H			
25 x 15,6 / 10 x 6 1/4	12,5 x 15,6 / 5 x 6 1/4	25 x 15,6 / 10 x 6 1/4	25 x 15,6 / 10 x 6 1/4			
244 x 150 x 8 mm	119 x 150 x 8 mm	244 x 150 x 8 mm	244 x 150 x 8 mm			
4,000	8,000	4,000	4,000			
0,620	0,300	0,620	0,620			
33	66	33	33			
8,250	8,250	8,250	8,250			
20,460	19,800	20,460	20,460			
Alb	Alb	Alb	Alb			
-/C	-/C	-/C	-/C			
900568-34136H	900568-34139H	900568-34137H	900568-34138H			
Preisgr. A452 (St.)	Preisgr. A428 (St.)	Preisgr. A467 (St.)	Preisgr. A467 (St.)			
900671-34136H	900671-34139H	900671-34137H	900671-34138H			
Preisgr. A452 (St.)	Preisgr. A428 (St.)	Preisgr. A467 (St.)	Preisgr. A467 (St.)			
900634-34136H	900634-34139H	900634-34137H	900634-34138H			
Preisgr. A452 (St.)	Preisgr. A428 (St.)	Preisgr. A467 (St.)	Preisgr. A467 (St.)			



Für die auf dieser Seite gezeigten Produkte wird kein Palettenrabatt gewährt.

Die dargestellten Produkte können auch in anderen Farben der Serie Chroma non-slip gefertigt werden. Gerne prüfen wir die Möglichkeit einer solchen Sonderproduktion im Einzelfall.

Gerundete Ecken			gerundete Ecken	Beispiel: Grundformat-Nr. 34166 = 119 x 244 x 15 mm, Format-Nr. 34167 = gerundete Ecke links
Grundformat-Nr. statt Endziffer 0 Endziffer 7 = Ecke links	... 8 = Ecke rechts		

Z. B. für Stehstufen, Steigleiternischen, enge Radien, Wendeflächen etc.

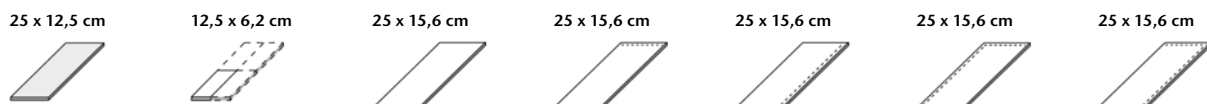

Riemchen, Lieferung als Vierfachriemchen, muss örtlich gebrochen werden

Riffelplatte			Kopfkante gerundet	Längskante gerundet	Ecke links gerundet	Ecke rechts gerundet	
34170H	34070H	34120H	34125H	34126H	34127H	34128H	
25 x 12,5 / 10 x 5	12,5 x 6,2 / 5 x 2 1/2	25 x 15,6 / 10 x 6 1/4	25 x 15,6 / 10 x 6 1/4	25 x 15,6 / 10 x 6 1/4	25 x 15,6 / 10 x 6 1/4	25 x 15,6 / 10 x 6 1/4	
244 x 119 x 8 mm	119 x 56 x 8 mm	244 x 150 x 8 mm	244 x 150 x 8 mm	244 x 150 x 8 mm	244 x 150 x 8 mm	244 x 150 x 8 mm	
32,000/m ²	128,000/m ²	25,000/m ²	6,410/m	4,000/m			
0,460	0,120	0,620	0,620	0,620	0,620	0,620	
33	132	33	33	33	33	33	
1,031 m ²	1,031 m ²	1,320 m ²	5,148 m	8,250 m			
15,180	15,840	20,460	20,460	20,460	20,460	20,460	
Alb	Alb	Alb	Alb	Alb	Alb	Alb	
	siehe unten	siehe unten	siehe unten	siehe unten	siehe unten	siehe unten	
700i-34170H	700i-34070H	700i-34120H	700i-34125H	700i-34126H	700i-34127H	700i-34128H	4
Preisgr. A283 (m ²)	Preisgr. A209 (m ²)	Preisgr. A167 (m ²)	Preisgr. A416 (St.)	Preisgr. A416 (St.)	Preisgr. A423 (St.)	Preisgr. A423 (St.)	neutral 10 (aktivweiß glzd.)
701i-34170H	701i-34070H	701i-34120H	701i-34125H	701i-34126H	701i-34127H	701i-34128H	4
Preisgr. A283 (m ²)	Preisgr. A209 (m ²)	Preisgr. A167 (m ²)	Preisgr. A416 (St.)	Preisgr. A416 (St.)	Preisgr. A423 (St.)	Preisgr. A423 (St.)	neutral 10 (aktivweiß matt)
552001-34170H	552001-34070H	552001-34120H	552001-34125H	552001-34126H	552001-34127H	552001-34128H	2
Preisgr. A310 (m ²)	Preisgr. A241 (m ²)	Preisgr. A210 (m ²)	Preisgr. A419 (St.)	Preisgr. A419 (St.)	Preisgr. A425 (St.)	Preisgr. A425 (St.)	azur aktiv
552002-34170H	552002-34070H	552002-34120H	552002-34125H	552002-34126H	552002-34127H	552002-34128H	4
Preisgr. A310 (m ²)	Preisgr. A241 (m ²)	Preisgr. A210 (m ²)	Preisgr. A419 (St.)	Preisgr. A419 (St.)	Preisgr. A425 (St.)	Preisgr. A425 (St.)	azur hell
5716i-34170H¹	5716i-34070H¹	5716i-34120H¹	5716i-34125H¹	5716-34126H¹	5716i-34127H¹	5716i-34128H¹	1
Preisgr. A310 (m ²)	Preisgr. A241 (m ²)	Preisgr. A210 (m ²)	Preisgr. A419 (St.)	Preisgr. A419 (St.)	Preisgr. A425 (St.)	Preisgr. A425 (St.)	neutral 1 (tiefschwarz)
-/B	-/B	-/B	-/B	-/B	-/B	-/B	
91i-34070H	91i-34120H	91i-34125H	91i-34126H	91i-34127H	91i-34128H	91i-34128H	neutral 10 (aktivweiß)
Preisgr. A256 (m ²)	Preisgr. A222 (m ²)	Preisgr. A423 (St.)	Preisgr. A423 (St.)	Preisgr. A428 (St.)	Preisgr. A428 (St.)	Preisgr. A428 (St.)	
-/B	-/B	-/B	-/B	-/B	-/B	-/B	
553001-34070H	553001-34120H	553001-34125H	553001-34126H	553001-34127H	553001-34128H	553001-34128H	azur aktiv
Preisgr. A271 (m ²)	Preisgr. A230 (m ²)	Preisgr. A425 (St.)	Preisgr. A425 (St.)	Preisgr. A430 (St.)	Preisgr. A430 (St.)	Preisgr. A430 (St.)	
-/B	-/B	-/B	-/B	-/B	-/B	-/B	
553002-34070H	553002-34120H	553002-34125H	553002-34126H	553002-34127H	553002-34128H	553002-34128H	azur hell
Preisgr. A271 (m ²)	Preisgr. A230 (m ²)	Preisgr. A425 (St.)	Preisgr. A425 (St.)	Preisgr. A430 (St.)	Preisgr. A430 (St.)	Preisgr. A430 (St.)	
-/B	-/B	-/B	-/B	-/B	-/B	-/B	
340i-34070H	340i-34120H	340i-34125H	340-34126	340i-34127H	340i-34128H	340i-34128H	neutral 1 (tiefschwarz)
Preisgr. A271 (m ²)	Preisgr. A230 (m ²)	Preisgr. A425 (St.)	Preisgr. A425 (St.)	Preisgr. A430 (St.)	Preisgr. A430 (St.)	Preisgr. A430 (St.)	

¹ Produktionsbedingt können Farbunterschiede zwischen Formstücken und Flächenware auftreten.

Sicherheitsriemchen (besonders geeignet zur trittsicheren und deutlich wahrnehmbaren Gestaltung von (Treppen-)Kanten)

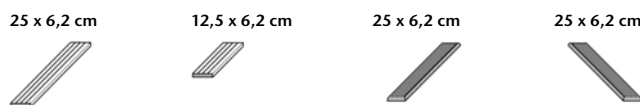

			gerillt, Längskante gerundet	„halbe“ Platte gerillt, Längskante gerundet	gerillt, Ecke links gerundet	gerillt, Ecke rechts gerundet	
			34306	34309	34307	34308	
			25 x 6,2 / 10 x 2 1/2	12,5 x 6,2 / 5 x 2 1/2	25 x 6,2 / 10 x 2 1/2	25 x 6,2 / 10 x 2 1/2	
			244 x 56 x 8 mm	119 x 56 x 8 mm	244 x 56 x 8 mm	244 x 56 x 8 mm	
			4,000	8,000	4,000	4,000	
			0,200	0,100	0,200	0,200	
			66	132	66	66	
			16,500	16,500	16,500	16,500	
			13,200	13,200	13,200	13,200	
			Alb	Alb	Alb	Alb	
			-/C	-/C	-/C	-/C	
			91-34306	91-34309	91-34307	91-34308	Formatnummer
			Preisgr. A431 (St.)	Preisgr. A416 (St.)	Preisgr. A434 (St.)	Preisgr. A434 (St.)	Nennmaß - cm/in
			553001-34306	553001-34309	553001-34307	553001-34308	Herstellmaß
			Preisgr. A434 (St.)	Preisgr. A418 (St.)	Preisgr. A438 (St.)	Preisgr. A438 (St.)	m - Stück
			553002-34306	553002-34309	553002-34307	553002-34308	Stück - kg
			Preisgr. A434 (St.)	Preisgr. A418 (St.)	Preisgr. A438 (St.)	Preisgr. A438 (St.)	Paket - Stück
			340-34306	340-34309	340-34307	340-34308	Paket - m
			Preisgr. A434 (St.)	Preisgr. A418 (St.)	Preisgr. A438 (St.)	Preisgr. A438 (St.)	Paket - kg
							Palette - m
							Palette - kg
							Produktnorm
							Trittsicherheit
							neutral 10 (aktivweiß)
							azur aktiv
							azur hell
							neutral 1 (tiefschwarz)

Die dargestellten Produkte können auch in anderen Farben der Serie Chroma und Chroma non-slip gefertigt werden. Gerne prüfen wir die Möglichkeit einer solchen Sonderproduktion im Einzelfall.

Für die auf dieser Seite gezeigten Produkte wird kein Palettenrabatt gewährt.

Sprossensteine Auftritt unglasiert in 900 graubeige gerillt



	Sprossenstein	Sprossenstein	Sprossenstein	Sprossenstein
Formatnummer	55563	55565	55566	55567
Nennmaß - cm/in				
Herstellmaß mm	244 x 80 x 50	282 x 80 x 50	244 x 160 x 50	282 x 160 x 50
m - Stück				
Stück - kg	1,600	1,830	3,150	3,500
Paket - Stück	10	9	5	4
Paket - m				
Paket - kg	16,000	16,470	15,750	14,000
Palette - m				
Palette - kg				
Produktnorm	Alb	Alb	Alb	Alb
Trittsicherheit	-/C	-/C	-/C	-/C
900 graubeige	700-55563	700-55565	700-55566	700-55567
700 n10/weiß glzd.	Preisgr. A581 (St.)	Preisgr. A593 (St.)	Preisgr. A698 (St.)	Preisgr. A708 (St.)
900 graubeige	701-55563	701-55565	701-55566	701-55567
701 n10/weiß matt	Preisgr. A581 (St.)	Preisgr. A593 (St.)	Preisgr. A698 (St.)	Preisgr. A708 (St.)
900 graubeige	552001-55563	552001-55565	552001-55566	552001-55567
552001 azur aktiv	Preisgr. A587 (St.)	Preisgr. A601 (St.)	Preisgr. A708 (St.)	Preisgr. A716 (St.)
900 graubeige	552002-55563	552002-55565	552002-55566	552002-55567
552002 azur hell	Preisgr. A587 (St.)	Preisgr. A601 (St.)	Preisgr. A708 (St.)	Preisgr. A716 (St.)
900 graubeige	5716-55563¹	5716-55565¹	5716-55566¹	5716-55567¹
5716 n1/schwarz	Preisgr. A587 (St.)	Preisgr. A601 (St.)	Preisgr. A708 (St.)	Preisgr. A716 (St.)



Bei diesen Formteilen ist der Auftritt unglasiert 900, alle anderen Flächen sind in der jeweiligen Chroma Farbe.

¹ Produktionsbedingt können Farbunterschiede zwischen Formstücken und Flächenware auftreten.

Schriftplatten

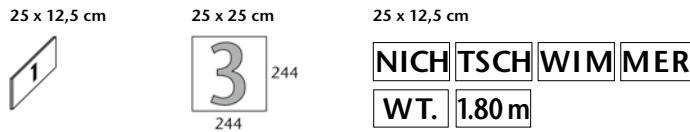

	Nummernplatte Schrifthöhe 7 cm	Nummernplatte Schrifthöhe 20 cm	Schriftplatte Schrifthöhe 7 cm	Schenkelplatte gerillt	„halbe“ Schenkelplatte gerillt
Formatnummer	38119	32059	S10002	37150	37155
Nennmaß - cm/in	25 x 12,5 / 10 x 5	25 x 25 / 10 x 10	25 x 12,5 / 10 x 5	25 x 12,5 / 10 x 5	12,5 x 12,5 / 5 x 5
Herstellmaß	244 x 119 x 8 mm	244 x 244 x 8 mm	244 x 119 x 8 mm	244 x 119/19 x 8 mm	119 x 119/19 x 8 mm
m - Stück			4,000	4,000	8,000
Stück - kg	0,490	1,060	0,490	2,000	2,000
Paket - Stück				20	40
Paket - m				5,000	5,000
Paket - kg				10,000	10,000
Palette - m					
Palette - kg					
Produktnorm	Alb	Alb	Alb	Alb	Alb
Trittsicherheit			-/B	-/C	-/C
700 n10/weiß glzd.	900659-38119	900659-32059			
552001 azur aktiv	Preisgr. A587 (St.)	Preisgr. A601 (St.)			
701 n10/weiß matt	900672-38119	900672-32059			
552001 azur aktiv	Preisgr. A587 (St.)	Preisgr. A601 (St.)			
700 n10/weiß glzd.	900673-38119	900673-32059			
5716 n1/schwarz	Preisgr. A587 (St.)	Preisgr. A601 (St.)			
701 n10/weiß matt	900644-38119	900644-32059			
5716 n1/schwarz	Preisgr. A587 (St.)	Preisgr. A601 (St.)			
91 n10/weiß			900567-S10002		
553001 azur aktiv			Preisgr. A649 (St.)		
91 n10/weiß			900044-S10002		
340 n1/schwarz			Preisgr. A649 (St.)		
graubeige				900-37150	900-37155
				Preisgr. A434 (St.)	Preisgr. A419 (St.)
				91-37150	91-37155
				Preisgr. A438 (St.)	Preisgr. A428 (St.)
neutral 10 / weiß					



Für die auf dieser Seite gezeigten Produkte wird kein Palettenrabatt gewährt.

Die dargestellten Produkte können auch in anderen Farben der Serie Chroma und Chroma non-slip gefertigt werden. Gerne prüfen wir die Möglichkeit einer solchen Sonderproduktion im Einzelfall.

Schenkelplatte (als Abdeckrost-Auflage)¹

25 x 12,5 cm

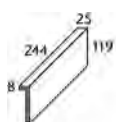

12,5 x 12,5 cm



25 x 12,5 cm



12,5 x 12,5 cm



25 x 3,3 cm

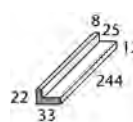

12,5 x 3,3 cm

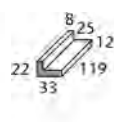

Schenkelplatte	„halbe“ Schenkelplatte	schräge Schenkelplatte	„halbe“ schräge Schenkelplatte	Rostauflegewinkel	„halber“ Rostauflegewinkel	
37011	37015	37017	37018	37031	37035	Formatnummer
25 x 12,5 / 10 x 5	12,5 x 12,5 / 5 x 5	25 x 12,5 / 10 x 5	12,5 x 12,5 / 5 x 5	25 x 3,3 / 10 x 1 3/8	12,5 x 3,3 / 5 x 1 3/8	Nennmaß - cm/in
244 x 119/25 x 8	119 x 119/25 x 8	244 x 125/25 x 8	119 x 125/25 x 8	244 x 33/22 x 8	119 x 33/22 x 8	Herstellmaß mm
4,000	8,000	4,000	8,000	4,000	8,000	m - Stück
0,600	0,290	0,620	0,300	0,200	0,100	Stück - kg
16	32	16	32	72	144	Paket - Stück
4,000	4,000	4,000	4,000	18,000	18,000	Paket - m
9,600	9,280	9,920	9,600	14,400	14,400	Paket - kg
						Palette - m
						Palette - kg
Alb	Alb	Alb	Alb	Alb	Alb	Produktnorm
700-37011	700-37015	700-37017	700-37018	700-37031	700-37035	neutral 10
Preisgr. A445 (St.)	Preisgr. A423 (St.)	Preisgr. A452 (St.)	Preisgr. A425 (St.)	Preisgr. A445 (St.)	Preisgr. A425 (St.)	(aktivweiß glzd.)
701-37011	701-37015	701-37017	701-37018	701-37031	701-37035	neutral 10
Preisgr. A445 (St.)	Preisgr. A423 (St.)	Preisgr. A452 (St.)	Preisgr. A425 (St.)	Preisgr. A445 (St.)	Preisgr. A425 (St.)	(aktivweiß matt)

¹ Abdeckroste siehe S. 442



Rinnenschale

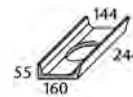
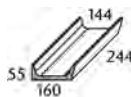

Art. Nr. 59680

			Rinnenschale Innen-Breite 144 mm	„halbe“ Rinnenschale	Rinnenschale mit Ablauf (ø 100 mm) ²	
			59680	59685	59681	Formatnummer
			244 x 160 x 55/15	119 x 160 x 55/15	244 x 160 x 55/15	Nennmaß - cm/in
			4,000	8,000		Herstellmaß mm
			1,700	0,850	1,550	m - Stück
			4	8	4	Stück - kg
			1,000	1,000		Paket - Stück
			6,800	6,800	6,200	Paket - m
						Paket - kg
						Palette - m
						Palette - kg
			Alb	Alb	Alb	Produktnorm
			700-59680	700-59685	700-59681	neutral 10
			Preisgr. A489 (St.)	Preisgr. A449 (St.)	Preisgr. A560 (St.)	(aktivweiß glzd.)
			701-59680	701-59685	701-59681	neutral 10
			Preisgr. A489 (St.)	Preisgr. A449 (St.)	Preisgr. A560 (St.)	(aktivweiß matt)

² Passender Flüsterablauf „Silent 100“ siehe S. 444

Für die auf dieser Seite gezeigten Produkte wird kein Palettenrabatt gewährt.

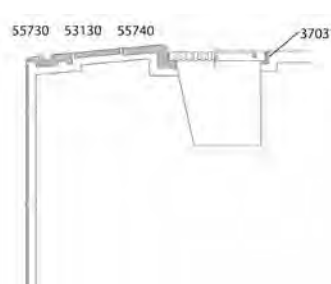
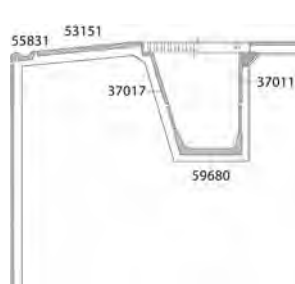
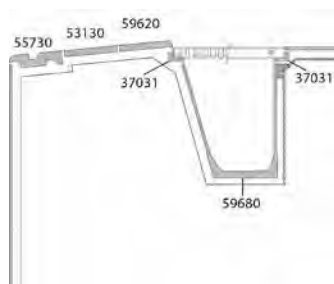

Flachrinnensystem (Muldentiefe 5 mm)

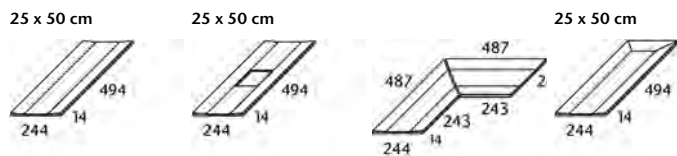

Art. Nr. 53320	Rinnenstein	Rinnenstein mit Ablauf 110 / 110 mm	Gehrungspaar	Endstück			
Formatnummer	53320	53321	53322	53323			
Nennmaß - cm/in	25 x 50 / 10 x 20	25 x 50 / 10 x 20		25 x 50 / 10 x 20			
Herstellmaß mm	494 x 244 x 14	494 x 244 x 14	(2x) 487 x 244 x 14	494 x 244 x 14			
m - Stück	2,000						
St./Paar - kg	2,500/Stück	2,300/Stück	3,800/Paar	2,500/Stück			
Paket - St./Paar	5 Stück	5 Stück	2 Paar	5 Stück			
Paket - m	2,500						
Paket - kg	12,500	11,500	7,600	12,500			
Palette - m							
Palette - kg							
Produktnorm	Alb	Alb	Alb	Alb			
Trittsicherheit	-/B	-/B	-/B	-/B			
	91-53320	91-53321	91-53322	91-53323			
neutral 10 (weiß)	Preisgr. A514 (St.)	Preisgr. A587 (St.)	Preisgr. A638 (Paar)	Preisgr. A587 (St.)			
	553002-53320	553002-53321	553002-53322	553002-53323			
azur hell	Preisgr. A519 (St.)	Preisgr. A593 (St.)	Preisgr. A645 (Paar)	Preisgr. A593 (St.)			



Auch als Sonderfertigung in der Serie Chroma unglasiert – Quantum machbar.

Flachrinnensystem (Muldentiefe 15 mm)



Art. Nr. 54420	Rinnenstein	Rinnenstein mit Ablauf 1 1/2"	Gehrungspaar	Endstück			
Formatnummer	54420	54421	54422	54423			
Nennmaß - cm/in	25 x 15,6 / 10 x 6 1/4	25 x 15,6 / 10 x 6 1/4		25 x 15,6 / 10 x 6 1/4			
Herstellmaß mm	244 x 150 x 30	244 x 150 x 30	(2x) 240 x 150 x 30	244 x 150 x 30			
m - Stück	4,000						
St./Paar - kg	1,800/Stück	1,530/Stück	3,030/Paar	1,950/Stück			
Paket - St./Paar	8 Stück	8 Stück	4 Paar	8 Stück			
Paket - m	2,000						
Paket - kg	14,400	12,240	12,120	15,600			
Palette - m							
Palette - kg							
Produktnorm	Alb	Alb	Alb	Alb			
Trittsicherheit	siehe unten	siehe unten	siehe unten	siehe unten			
	R10/A	R10/A	R10/A	R10/A			
graubeige	900-54420	900-54421	900-54422	900-54423			
	Preisgr. A458 (St.)	Preisgr. A560 (St.)	Preisgr. A581 (Paar)	Preisgr. A560 (St.)			
grauweiß	R11/B	R11/B	R11/B	R11/B			
	902R-54420	902R-54421	902R-54422	902R-54423			
	Preisgr. A458 (St.)	Preisgr. A560 (St.)	Preisgr. A581 (Paar)	Preisgr. A560 (St.)			
	-/B	⊗	-/B	⊗			
neutral 10 (weiß)	91-54420	91-54421	91-54422	91-54423			
	Preisgr. A475 (St.)	Preisgr. A577 (St.)	Preisgr. A601 (Paar)	Preisgr. A577 (St.)			



passender Einsatz für Ablauf: Artikel-Nr. 182 siehe S. 444 (Einbau vor Verlegung).

Für die auf dieser Seite gezeigten Produkte wird kein Palettenrabatt gewährt.

Projekt: Beitostølen Helseportsenter, Beitostølen, Norwegen / Architekt: Agrob Buchtal Norge AS/Architektenservice Agrob Buchtal
in Zusammenarbeit mit dem Bauherrn und Verleger / Serie: Quarzit / Foto: Tove Lauluten



Serie: Beckenkopfsystem Wiesbaden Silent





3D-Rendering / Serie: Area Pro





Keramische Rinnenabdeckung für Privat- und Hotelbäder

Exklusive Möglichkeiten der Gestaltung eröffnet das Beckenkopfsystem „Wiesbaden Stil“: Durch die Verwendung der keramischen Rinnenabdeckung lässt sich der gesamte Beckenumgang bis an den Beckenrand in einheitlicher Optik ausführen. Dabei stehen die Farben und die speziellen Oberflächen der Fliesenserien Quarzit, Valley und Emotion zur Verfügung. Auch die Träger und Grundplatten der Rinnenabdeckung werden farblich entsprechend angepasst. Die Abdeckung ist trittsicher und hoch belastbar. Steckverbindungen sorgen für eine schnelle und einfache Verlegung. Auf Wunsch sind auch unterschiedliche Formate und freie Formen lieferbar. Wasserdurchsatz: freier Querschnitt 245 cm²/m beim Standard-Lochmuster.

Querschnitt

Deckplatte 8 mm
(Quarzit)

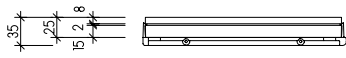

Außenecke

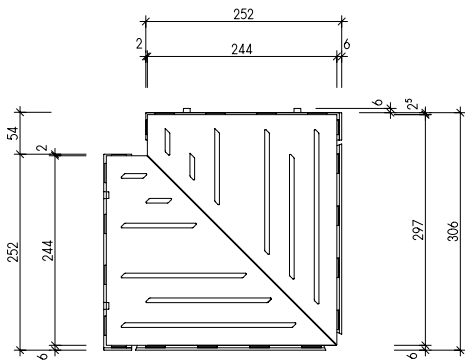

Querschnitt

Deckplatte 10,5 mm (Emotion)
Deckplatte 10 mm (Valley)

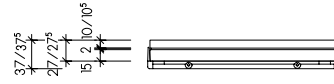

Innenecke

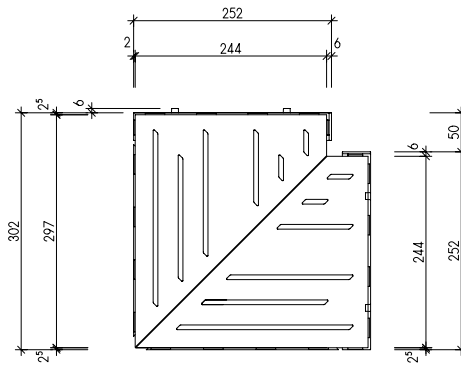

Keramischer Abdeckrost

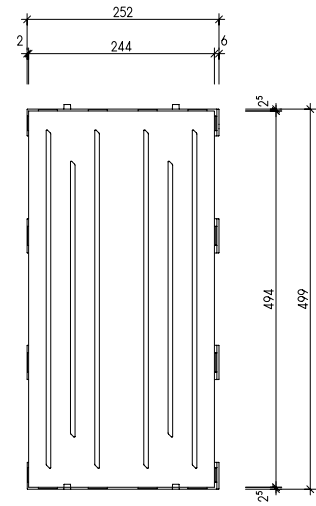

Erhältliche Oberflächen:

Area Pro, Emotion, Quarzit, Valley



3D-Rendering / Serie: Area Pro

Gilt nur für das keramische Belagsmaterial:
 Stranggepr. keram. Platten, Präzision, DIN EN 14411, Gruppe Al_b,
 unglasiert (UGL) für Bodenbeläge und Wandbekleidungen im
 Innen- und Außenbereich (Feinsteinzeugplatten) //
 Trockengepr. keram. Fliesen, DIN EN 14411, Gruppe Bl_a, unglasiert (UGL)
 für Bodenbeläge und Wandbekleidungen im Innen- und Außenbereich
 (Feinsteinzeugfliesen)

Außenecke Innenecke

25 x 50 cm

30 x 30 cm

30 x 30 cm



Design Quarzit

Design Quarzit

Design Quarzit

53510H	53512H	53511H
25 x 50 / 10 x 20	30 x 30 / 12 x 12	30 x 30 / 12 x 12
252 x 500 x 35 ^{2/3}	252 x 302/302 x 35 ^{2/4}	252 x 302/302 x 35 ^{2/4}
2		
12,212/m	4,312/Stück	4,312/Stück
1	1	1
0,500		
6,106	4,312	4,312
Alb	Alb	Alb
R11/B	R11/B	R11/B
8462-53510H ¹	8462-53512H ¹	8462-53511H ¹
Preisgr. A731 (St.)	Preisgr. A781 (St.)	Preisgr. A781 (St.)



Formatnummer
Nennmaß - cm/in
Herstellmaß mm
m - Stück
m/St. - kg
Paket - Stück
Paket - m
Paket - kg
Palette - m
Palette - kg
Produktnorm
Trittsicherheit
sandbeige



¹ Auftragsbezogene Fertigung, Lieferzeit auf Anfrage.
 Weitere Farben / Designs auf Anfrage umsetzbar.

² Elementgröße in verbautem Zustand inkl. Fuge

³ komplettes Element inkl. Zapfen: 252 x 506 x 35 mm

⁴ komplettes Element inkl. Zapfen: 252 x 302/309 x 35 mm

Hinweis: laut DIN 19643-1 sind die Volumenströme in Bezug zum freien Querschnitt der keramischen Rinnenabdeckung nachzuweisen.

Freier Querschnitt: ca. 245 cm²/m

Außenecke Innenecke

25 x 50 cm

30 x 30 cm

30 x 30 cm



Design Valley
strukturiert, vergütet

Design Valley
strukturiert, vergütet

Design Valley
strukturiert, vergütet

53510	53512	53511
25 x 50 / 10 x 20	30 x 30 / 12 x 12	30 x 30 / 12 x 12
252 x 500 x 37 ^{2/3}	252 x 302/302 x 37 ^{2/4}	252 x 302/302 x 37 ^{2/4}
2		
13,274/m	4,687/Stück	4,687/Stück
1	1	1
0,500		
6,637	4,687	4,687
Bla	Bla	Bla
R11/B	R11/B	R11/B
052036-53510 ¹	052036-53512 ¹	052036-53511 ¹
Preisgr. A731 (St.)	Preisgr. A781 (St.)	Preisgr. A781 (St.)



Formatnummer
Nennmaß - cm/in
Herstellmaß mm
m - Stück
m/St. - kg
Paket - Stück
Paket - m
Paket - kg
Palette - m
Palette - kg
Produktnorm
Trittsicherheit
schiefer



¹ Auftragsbezogene Fertigung, Lieferzeit auf Anfrage.
 Weitere Farben / Designs auf Anfrage umsetzbar.

² Elementgröße in verbautem Zustand inkl. Fuge

³ komplettes Element inkl. Zapfen: 252 x 506 x 37 mm

⁴ komplettes Element inkl. Zapfen: 252 x 302/309 x 37 mm

Hinweis: laut DIN 19643-1 sind die Volumenströme in Bezug zum freien Querschnitt der keramischen Rinnenabdeckung nachzuweisen.

Freier Querschnitt: ca. 245 cm²/m

Abdeckroste in Spitzenqualität

Auch bei Details, die oft kaum beachtet werden, zählt sich hohe Qualität aus: Abdeckroste von Agrob Buchtal, wahlweise als Quer- oder Parallelroste lieferbar, sind aus extrem schlagfestem Kunststoff, hochwertigem, hochschlagzähen Kunststoff mit UV Absorber, Verbindung der Einzelstäbe mittels reißfester PUR Rundschnur und farblich zu den Einzelstäben passenden Zwischenrollen. Roste für die zu erwartenden Belastungen durch Barfußbegehungen ausgelegt. Ein Durchtreten einzelner Stäbe ist nahezu ausgeschlossen.



Querrost

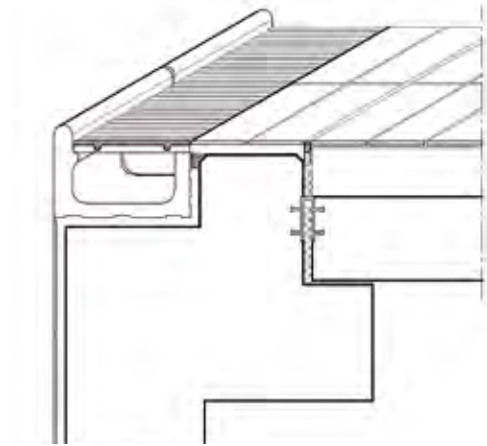

Parallelrost

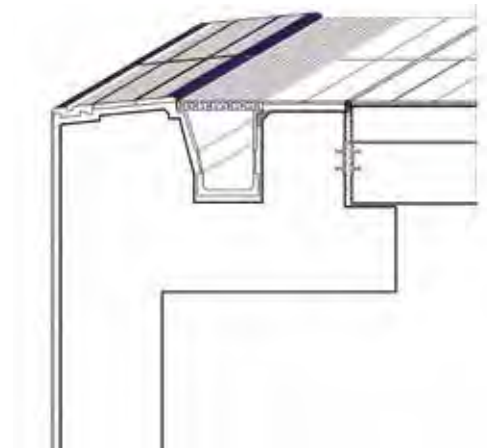

Querrost flexibel

Roststabhöhe	25 mm	25 mm
Rostbreite	191 mm ¹	250 mm
Artikel-Nr.	R10000	R10100
Querrost flexibel	Preisgr. A722 (lfm.)	Preisgr. A731 (lfm.)

Querrost starr für die Flüsterrinne¹

Roststabhöhe	25 mm	25 mm
Rostbreite	191 mm ¹	250 mm
Artikel-Nr.	R20000	R20100
Querrost	Preisgr. A731 (lfm.)	Preisgr. A735 (lfm.)
Artikel-Nr.	R21000	R21100
Gehrungsecken 1E+AE+Sonder ²	Preisgr. A735 (St.)	Preisgr. A742 (St.)

¹ Auch als Fächerecke und Bogenrost lieferbar. Preise auf Anfrage.
² Alle Eckelemente sind starr ausgebildet.

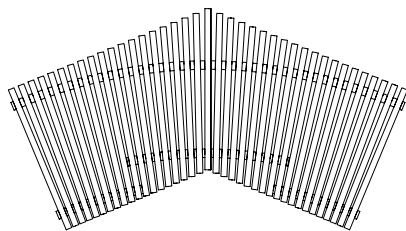

Fächerecke Art. Nr.: R12100
Querrost 250 mm breit

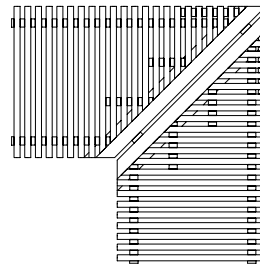

Gehrungsecke Art. Nr.: R21100
Querrost 250 mm breit

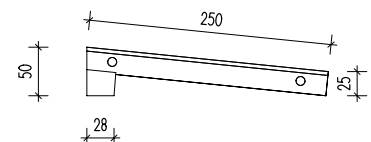

Art. Nr.: R40100
Schräger Querrost 250 mm breit

Parallelrost starr⁴

Roststabhöhe	25 mm
Rostbreite	250 mm
Artikel-Nr.	R50100
Parallelrost	Preisgr. A748 (lfm.)
Artikel-Nr.	R51100
Gehrungsecken 1E+AE+Sonder ³	Preisgr. A783 (St.)

³ Alle Eckelemente sind starr ausgebildet.
⁴ Aus technischen Gründen nicht als Bogenrost lieferbar.

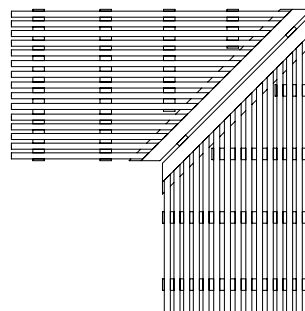

Gehrungsecke Art. Nr.: R51100
Parallelrost 250 mm breit

Farbübersicht:

- Unterscheidung über letzte Ziffer der Artikelnummer
- Letzte Ziffer 0 = Standardfarben (grau = RAL7001 / weiß = RAL9010 / beige = RAL1001 / gelb = RAL1018)
- Letzte Ziffer 1 = Semifarben hellelfenbein = RAL 1015 / verkehrsblau = RAL5017 / verkehrsrot = RAL3020 / tiefschwarz = RAL9005)
- Letzte Ziffer 2 = Sonderfarben nach RAL (außer Metallic Töne)

Flüsterablauf Silent W 2000
(gesetzlich geschützt)

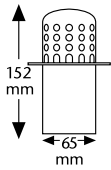

Flüsterablauf Silent 100
(gesetzlich geschützt)
Mit optimiertem Verbindungssystem

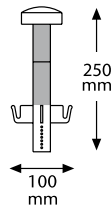

Ablauf
(Messing mit Sieb in V4A)

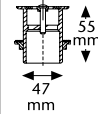

Ablaufleistung
max. 2,4 m³/h
(Einbau mit Rinnenstein)

Der Wasserablauf erfolgt spürbar geräuschärmer bei deutlich gesteigertem Wasserdurchsatz. Silent W 2000 und Silent 100 bestehen aus hochwertigem Spezialwerkstoff (PVC-frei), der gegen Chlor-, Salz-, Thermal-, Mineral- und ozonversetztes Wasser ebenso beständig ist wie gegen im Schwimmbad üblicherweise eingesetzte Reinigungsmittel.

Ø 75 mm	Ø 86 mm	Ø 100 mm	1 1/2 Zoll	Passend für Öffnungen mit
Passend für Überlaufrinne 55141, 86161	Passend für Überlaufrinnen 55101, 85161, 55181, 85191, 95161, 87161, 85181	Passend für Rinnenschale 59681	Passend zu Rinnenstein 54421	
178 Preisgr. A723 (St.)	179 Preisgr. A723 (St.)	177 Preisgr. A723 (St.)	182 Preisgr. A668 (St.)	Artikel-Nr.
178-S (schwarz) Preisgr. A731 (St.)	179-S (schwarz) Preisgr. A731 (St.)			Artikel-Nr.

Achtung: Gesonderte Rabattregelung bei Zubehör!

Für die auf dieser Seite gezeigten Produkte wird kein Palettenrabatt gewährt.

Projekt: Paracelsus Bad & Kurhaus / Standort: Salzburg, Österreich / Architekt: Berger + Parkkinen /
 Serie: Beckenkopfsystem Wiesbaden, Savona / Foto: Christian Richters

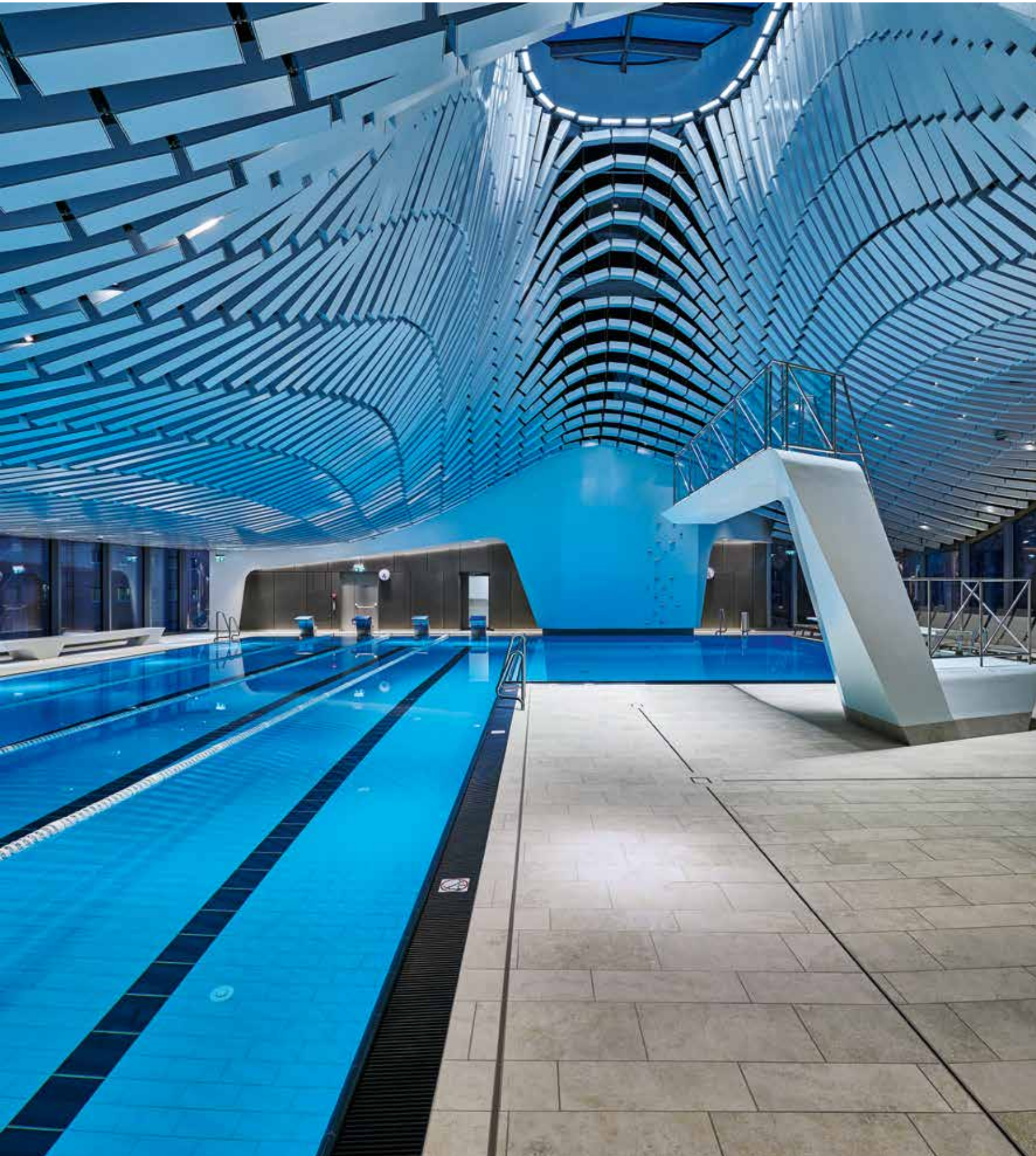





Inhalt

• Artikelnummern	448
• Formate	460
• Formatnummern	462
• Zuordnungen CS/RAL / Hellbezugswerte	464
• Leuchtdichtekontrast	466

Technische Informationen	468
Vertriebskontakte D-A-CH	486
Erläuterungen	489

Artikel-Nr.	Seite	Artikel-Nr.	Seite	Artikel-Nr.	Seite	Artikel-Nr.	Seite	Artikel-Nr.	Seite	Artikel-Nr.	Seite
010S-1010	216	052236	304	113-1038H	240	116-1016H	238	120-1117H	238	140-1026H	240
010S-1630	216	052237	304	113-1039H	240	116-1017H	240	120-1118H	238	140-1027H	240
010S-4822	217	052238	304	113-1040H	240	116-1018H	240	120-1119H	238	140-1028H	240
010S-9066	217	052239	304	113-1111H	238	116-1019H	240	120-1120H	238	140-1029H	240
010S-9330	218	052240	304	113-1112H	238	116-1020H	240	120-1121H	238	140-1030H	240
010S-9335	218	052241	304	113-1113H	238	116-1021H	240	130-1001H	238	140-1031H	240
010S-9337	218	052242	304	113-1114H	238	116-1022H	240	130-1002H	238	140-1032H	240
010S-9338	218	052243	304	113-1115H	238	116-1023H	240	130-1003H	238	140-1033H	240
010S-9570	217	052244	304	113-1116H	238	116-1024H	240	130-1004H	238	140-1034H	240
010S-9573	217	052245	304	113-1117H	238	116-1025H	240	130-1005H	238	140-1035H	240
010S-9574	217	052246	304	113-1118H	238	116-1026H	240	130-1006H	238	140-1036H	240
052016	316	052247	304	113-1119H	238	116-1027H	240	130-1007H	238	140-1037H	240
052017	316	052248	304	113-1120H	238	116-1028H	240	130-1008H	238	140-1038H	240
052018	316	052249	304	113-1121H	238	116-1029H	240	130-1009H	238	140-1039H	240
052019	316	052265	304	113063	81	116-1030H	240	130-1010H	238	140-1040H	240
052020	316	052266	304	115-1001H	238	116-1031H	240	130-1011H	238	140-1111H	238
052021	316	052267	304	115-1002H	238	116-1032H	240	130-1012H	238	140-1112H	238
052022	316	052268	304	115-1003H	238	116-1033H	240	130-1013H	238	140-1113H	238
052023	316	052269	304	115-1004H	238	116-1034H	240	130-1014H	238	140-1114H	238
052024	316	052461	316	115-1005H	238	116-1035H	240	130-1015H	238	140-1115H	238
052025	316	052462	316	115-1006H	238	116-1036H	240	130-1016H	238	140-1116H	238
052026	316	052463	316	115-1007H	238	116-1037H	240	130-1017H	240	140-1117H	238
052027	316	052464	316	115-1008H	238	116-1038H	240	130-1018H	240	140-1118H	238
052028	316	052477	316	115-1009H	238	116-1039H	240	130-1019H	240	140-1119H	238
052029	316	052478	316	115-1010H	238	116-1040H	240	130-1020H	240	140-1120H	238
052030	316	052479	316	115-1011H	238	116-1111H	238	130-1021H	240	140-1121H	238
052031	316	052480	316	115-1012H	238	116-1112H	238	130-1022H	240	144-12020	107, 336
052032	316	070S-1010	216	115-1013H	238	116-1113H	238	130-1023H	240	144-12050	107, 336
052033	316	070S-1630	216	115-1014H	238	116-1114H	238	130-1024H	240	144-18120	107, 336
052034	316	070S-4822	217	115-1015H	238	116-1115H	238	130-1025H	240	144-18210	107, 336
052035	316	070S-9066	217	115-1016H	238	116-1116H	238	130-1026H	240	144-41550K	107, 336
052036	316	070S-9330	218	115-1017H	240	116-1117H	238	130-1027H	240	144-42550K	107, 336
052036-53510	441	070S-9335	218	115-1018H	240	116-1118H	238	130-1028H	240	150i-12020H	107, 336
052036-53511	441	070S-9337	218	115-1019H	240	116-1119H	238	130-1029H	240	150i-12050H	107, 336
052036-53512	441	070S-9338	218	115-1020H	240	116-1120H	238	130-1030H	240	150i-18120H	107, 336
052037	316	070S-9570	217	115-1021H	240	120-1001H	238	130-1031H	240	150i-18210H	107, 336
052038	316	070S-9573	217	115-1022H	240	120-1002H	238	130-1032H	240	150i-41550HK	107, 336
052039	316	070S-9574	217	115-1023H	240	120-1003H	238	130-1033H	240	150i-42550HK	107, 336
052044	316	101630-6635	99	115-1024H	240	120-1004H	238	130-1034H	240	151i-12020H	107, 336
052045	316	101630-6636	99	115-1025H	240	120-1005H	238	130-1035H	240	151i-12050H	107, 336
052046	316	103197-6635	99	115-1026H	240	120-1006H	238	130-1036H	240	151i-18120H	107, 336
052047	316	103197-6636	99	115-1027H	240	120-1007H	238	130-1037H	240	151i-18210H	107, 336
052048	316	111052	81	115-1028H	240	120-1008H	238	130-1038H	240	151i-41550HK	107, 336
052049	316	112000	81	115-1029H	240	120-1009H	238	130-1039H	240	151i-42550HK	107, 336
052050	316	113-1001H	238	115-1030H	240	120-1010H	238	130-1040H	240	152i-12020H	107, 336
052051	316	113-1002H	238	115-1031H	240	120-1011H	238	130-1111H	238	152i-12050H	107, 336
052052	316	113-1003H	238	115-1032H	240	120-1012H	238	130-1112H	238	152i-18120H	107, 336
052053	316	113-1004H	238	115-1033H	240	120-1013H	238	130-1113H	238	152i-18210H	107, 336
052054	316	113-1005H	238	115-1034H	240	120-1014H	238	130-1114H	238	152i-41550HK	107, 336
052055	316	113-1006H	238	115-1035H	240	120-1015H	238	130-1115H	238	152i-42550HK	107, 336
052068	317	113-1007H	238	115-1036H	240	120-1016H	238	130-1116H	238	153i-12020H	107, 336
052069	317	113-1008H	238	115-1037H	240	120-1017H	240	130-1117H	238	153i-12050H	107, 336
052070	317	113-1009H	238	115-1038H	240	120-1018H	240	130-1118H	238	153i-18120H	107, 336
052071	317	113-1010H	238	115-1039H	240	120-1019H	240	130-1119H	238	153i-18210H	107, 336
052072	317	113-1011H	238	115-1040H	240	120-1020H	240	130-1120H	238	153i-41550HK	107, 336
052073	317	113-1012H	238	115-1111H	238	120-1021H	240	130-1121H	238	153i-42550HK	107, 336
052074	317	113-1013H	238	115-1112H	238	120-1022H	240	140-1001H	238	154i-12020H	107, 336
052075	317	113-1014H	238	115-1113H	238	120-1023H	240	140-1002H	238	154i-12050H	107, 336
052081	317	113-1015H	238	115-1114H	238	120-1024H	240	140-1003H	238	154i-18120H	107, 336
052082	317	113-1016H	238	115-1115H	238	120-1025H	240	140-1004H	238	154i-18210H	107, 336
052083	317	113-1017H	240	115-1116H	238	120-1026H	240	140-1005H	238	154i-41550HK	107, 336
052084	317	113-1018H	240	115-1117H	238	120-1027H	240	140-1006H	238	154i-42550HK	107, 336
052085	317	113-1019H	240	115-1118H	238	120-1028H	240	140-1007H	238	160-1001H	238
052086	317	113-1020H	240	115-1119H	238	120-1029H	240	140-1008H	238	160-1002H	238
052087	317	113-1021H	240	115-1121H	238	120-1030H	240	140-1009H	238	160-1003H	238
052088	317	113-1022H	240	115100	81	120-1031H	240	140-1010H	238	160-1004H	238
052089	316	113-1023H	240	116-1001H	238	120-1032H	240	140-1011H	238	160-1005H	238
052090	316	113-1024H	240	116-1002H	238	120-1033H	240	140-1012H	238	160-1006H	238
052091	316	113-1025H	240	116-1003H	238	120-1034H	240	140-1013H	238	160-1007H	238
052092	316	113-1026H	240	116-1004H	238	120-1035H	240	140-1014H	238	160-1008H	238
052225	304	113-1027H	240	116-1005H	238	120-1036H	240	140-1015H	238	160-1009H	238
052226	304	113-1028H	240	116-1006H	238	120-1037H	240	140-1016H	238	160-1010H	238
052227	304	113-1029H	240	116-1007H	238	120-1038H	240	140-1017H	240	160-1011H	238
052228	304	113-1030H	240	116-1008H	238	120-1039H	240	140-1018H	240	160-1012H	238
052229	304	113-1031H	240	116-1009H	238	120-1040H	240	140-1019H	240	160-1013H	238
052230	304	113-1032H	240	116-1010H	238	120-1111H	238	140-1020H	240	160-1014H	238
052231	304	113-1033H	240	116-1011H	238	120-1112H	238	140-1021H	240	160-1015H	238
052232	304	113-1034H	240	116-1012H	238	120-1113H	238	140-1022H	240	160-1016H	238
052233	304	113-1035H	240	116-1013H	238	120-1114H	238	140-1023H	240	160-1017H	240
052234	304	113-1036H	240	116-1014H	238	120-1115H	238	140-1024H	240	160-1018H	240
052235	304	113-1037H	240	116-1015H	238	120-1116H	238	140-1025H	240	160-1019H	240

Artikel-Nr.	Seite	Artikel-Nr.	Seite	Artikel-Nr.	Seite	Artikel-Nr.	Seite	Artikel-Nr.	Seite	Artikel-Nr.	Seite
160-1020H	240	203234H	54	239997	81	260-1026H	241	340-55732	361	360-1008H	239
160-1021H	240	203264	82	239998	81	260-1027H	241	340-55735	361	360-1009H	239
160-1022H	240	203265	82	240-1001H	239	260-1028H	241	340-55736	361	360-1010H	239
160-1023H	240	203266H	83	240-1002H	239	260-1029H	241	340-55737	361	360-1011H	239
160-1024H	240	203267H	83	240-1003H	239	260-1030H	241	340-55738	361	360-1012H	239
160-1025H	240	212120	270	240-1004H	239	260-1031H	241	340-55740	363	360-1013H	239
160-1026H	240	212121	270	240-1005H	239	260-1032H	241	340-55742	363	360-1014H	239
160-1027H	240	212122	270	240-1006H	239	260-1033H	241	340-55745	363	360-1015H	239
160-1028H	240	212123	270	240-1007H	239	260-1034H	241	340-55749	363	360-1016H	239
160-1029H	240	212124	270	240-1008H	239	260-1035H	241	340-55760	362	360-1017H	241
160-1030H	240	212142	270	240-1009H	239	260-1036H	241	340-55762	362	360-1018H	241
160-1031H	240	213341	81	240-1010H	239	260-1037H	241	340-55765	362	360-1019H	241
160-1032H	240	213342	81	240-1011H	239	260-1038H	241	340-55766	362	360-1020H	241
160-1033H	240	220-1001H	239	240-1012H	239	260-1039H	241	340-55770	362	360-1021H	241
160-1034H	240	220-1002H	239	240-1013H	239	260-1040H	241	340-55775	362	360-1022H	241
160-1035H	240	220-1003H	239	240-1014H	239	260-1111H	239	340-55820	367	360-1023H	241
160-1036H	240	220-1004H	239	240-1015H	239	260-1112H	239	340-55821	367	360-1024H	241
160-1037H	240	220-1005H	239	240-1016H	239	260-1113H	239	340-55822	367	360-1025H	241
160-1038H	240	220-1006H	239	240-1017H	241	260-1114H	239	340-55825	367	360-1026H	241
160-1039H	240	220-1007H	239	240-1018H	241	260-1115H	239	340-55826	367	360-1027H	241
160-1040H	240	220-1008H	239	240-1019H	241	260-1116H	239	340-55830	367	360-1028H	241
160-1111H	238	220-1009H	239	240-1020H	241	260-1117H	239	340-55831	367	360-1029H	241
160-1112H	238	220-1010H	239	240-1021H	241	260-1118H	239	340-55832	367	360-1030H	241
160-1113H	238	220-1011H	239	240-1022H	241	260-1119H	239	340-55835	367	360-1031H	241
160-1114H	238	220-1012H	239	240-1023H	241	260-1120H	239	340-55836	367	360-1032H	241
160-1115H	238	220-1013H	239	240-1024H	241	260-1121H	239	340-55840	368	360-1033H	241
160-1116H	238	220-1014H	239	240-1025H	241	260713	83	340-55841	368	360-1034H	241
160-1117H	238	220-1015H	239	240-1026H	241	268099	83	340-55845	368	360-1035H	241
160-1118H	238	220-1016H	239	240-1027H	241	269478	82	340-59420	361	360-1036H	241
160-1119H	238	220-1017H	241	240-1028H	241	269479	82	340-59422	361	360-1037H	241
160-1120H	238	220-1018H	241	240-1029H	241	280374	82	340-59425	361	360-1038H	241
160-1121H	238	220-1019H	241	240-1030H	241	280375	82	340-59426	361	360-1039H	241
173339	81	220-1020H	241	240-1031H	241	280718	82	340-59427	361	360-1040H	241
173340	81	220-1021H	241	240-1032H	241	280719	82	340-59428	361	360-1111H	239
173368	81	220-1022H	241	240-1033H	241	280871	82	340-59620	427	360-1112H	239
173369	81	220-1023H	241	240-1034H	241	280872	82	340-59627	427	360-1113H	239
177	444	220-1024H	241	240-1035H	241	281757H	152	340-59628	427	360-1114H	239
178	444	220-1025H	241	240-1036H	241	281758H	152	340-59629	427	360-1115H	239
178-5	444	220-1026H	241	240-1037H	241	281759H	152	340-59630	427	360-1116H	239
179	444	220-1027H	241	240-1038H	241	282115R-02	82	340-59637	427	360-1117H	239
179-5	444	220-1028H	241	240-1039H	241	282116R-02	82	340-59638	427	360-1118H	239
182	444	220-1029H	241	240-1040H	241	282887R	83	340-59639	427	360-1119H	239
182763	81	220-1030H	241	240-1111H	239	282888R	83	340i-32020H	113, 341	360-1120H	239
182764	81	220-1031H	241	240-1112H	239	283345	82	340i-32025H	113, 341	360-1121H	239
183343	81	220-1032H	241	240-1113H	239	283346	82	340i-32027H	113, 341	381467	83
183344	81	220-1033H	241	240-1114H	239	289358	83	340i-32050H	113, 341	381468	83
19020-2290	137	220-1034H	241	240-1115H	239	289359	83	340i-32055H	113, 341	381474	81
19020-2320	137	220-1035H	241	240-1116H	239	289360	83	340i-32057H	113, 341	381475	81
19020-9215	137	220-1036H	241	240-1117H	239	289361	83	340i-34070H	431	381799H	310
19021-2290	137	220-1037H	241	240-1118H	239	323235H	54	340i-34120H	431	391572	83
19021-2320	137	220-1038H	241	240-1119H	239	323236H	54	340i-34125H	431	391573	83
19021-9215	137	220-1039H	241	240-1120H	239	323237H	54	340i-34127H	431	391589	82
19022-2290	137	220-1040H	241	240-1121H	239	323260	82	340i-34128H	431	391590	82
19022-2320	137	220-1111H	239	2401RH-K100-21	145	323261	82	340i-34146H	425	40000H	206
19022-9215	137	220-1112H	239	2452	179	323262H	83	340i-34147H	425	40001H	206
19024-2290	137	220-1113H	239	2455	179	323263H	83	340i-34148H	425	40002H	206
19024-2320	137	220-1114H	239	260-1001H	239	340-34126	431	340i-34149H	425	40003H	206
19024-9215	137	220-1115H	239	260-1002H	239	340-34306	431	340i-34156H	425	40004H	206
19025-2290	137	220-1116H	239	260-1003H	239	340-34307	431	340i-34157H	425	40005H	206
19025-2320	137	220-1117H	239	260-1004H	239	340-34308	431	340i-34158H	425	40006H	206
19025-9215	137	220-1118H	239	260-1005H	239	340-34309	431	340i-34159H	425	40007H	206
19026-2290	137	220-1119H	239	260-1006H	239	340-37120	419	340i-38110H	113, 341	40008H	206
19026-2320	137	220-1120H	239	260-1007H	239	340-37121	419	340i-38115H	113, 341	40009H	206
19026-9215	137	220-1121H	239	260-1008H	239	340-37122	419	340i-38116H	113, 341	40010H	206
19027-2290	137	2203-B600HK	197	260-1009H	239	340-37125	420	340i-38117H	113, 341	40011H	206
19027-2320	137	2204-B600HK	197	260-1010H	239	340-37126	420	340i-38118H	113, 341	40012H	206
19027-9215	137	2205-B600HK	197	260-1011H	239	340-37127	420	353022	82	40013H	206
19030-2290	137	2206-B600HK	197	260-1012H	239	340-37180	419	353023	82	40014	206
19030-2320	137	2207-B600HK	197	260-1013H	239	340-37182	419	353024	83	40020H	206
19030-9215	137	2208-B600HK	197	260-1014H	239	340-37183	420	353025	83	40021H	206
19031-2290	137	228522	83	260-1015H	239	340-37185	420	3555-1110	145	40022H	206
19031-2320	137	228523	83	260-1016H	239	340-37188	419	3555-4000	145	40023H	206
19031-9215	137	228845	83	260-1017H	241	340-37189	420	3555-4003	145	40024H	206
19032-2290	137	229480	82	260-1018H	241	340-53150	368	3555-4004	145	40025H	206
19032-2320	137	229481	82	260-1019H	241	340-53151	368	360-1001H	239	40026H	206
19032-9215	137	229482	82	260-1020H	241	340-53159	368	360-1002H	239	40027H	206
19033-2290	137	229483	82	260-1021H	241	340-55720	362	360-1003H	239	40028H	206
19033-2320	137	231032	81	260-1022H	241	340-55722	362	360-1004H	239	40029H	206
19033-9215	137	231034	81	260-1023H	241	340-55725	362	360-1005H	239	40030H	206
203232H	54	239995	81	260-1024H	241	340-55729	362	360-1006H	239	40031H	206
203233H	54	239996	81	260-1025H	241	340-55730	361	360-1007H	239	40032H	206

Artikel-Nr.	Seite	Artikel-Nr.	Seite	Artikel-Nr.	Seite	Artikel-Nr.	Seite	Artikel-Nr.	Seite	Artikel-Nr.	Seite
363335	82	41402H-73	180	430236H	54	430325H	56	430407H	57	430485H	58
363336	82	41403H-73	180	430237H	54	430326H	56	430407HDTB	299	430486H	58
363337H	83	41404H-73	180	430238H	54	430327H	56	430407HDTL	299	430487H	58
363338H	83	41405H-73	180	430239H	54	430328H	56	430407HKSL	299	430488H	58
40033H	206	41406H	180	430240H	54	430329H	56	430407HKSM	299	430489H	58
40034	206	41407H	180	430241H	54	430330H	56	430407HWTB	299	430490H	58
40040H	207	41408H	180	430242H	54	430331H	56	430407HWTL	299	430491H	58
40041H	207	41409H	180	430243H	54	430332H	56	430407HWTS	299	430492H	58
40042H	207	41410H	180	430244H	55	430333H	56	430408H	57	430493H	58
40044H	207	41411H	180	430245H	55	430334H	56	430409H	57	430494H	58
40047H	207	41412H	180	430246H	55	430335H	56	430410H	57	430495H	58
40048H	207	41413H	180	430249H	55	430336H	56	430411H	57	430496H	58
40050H	206	41414H	180	430250H	55	430337H	56	430412H	57	430497H	58
40051H	206	41415H	180	430253H	55	430338H	56	430413H	57	430498H	58
40052H	206	41420H	180	430256H	55	430339H	56	430414H	57	430499H	58
40053H	206	41421H	180	430257H	55	430340H	56	430415H	57	430500H	58
40054H	206	41422H	180	430258H	55	430340H-TK	60	430416H	57	430501H	58
40055H	206	41423H	180	430261H	55	430341H	56	430417H	57	430502H	58
40056H	206	41424H	180	430262H	55	430342H	56	430418H	57	430503H	58
40057H	206	41425H	180	430265H	55	430343H	56	430419H	57	430504H	59
40071H	207	41426H	180	430268H	55	430344H	56	430420H	57	430505H	59
410-2008	264	41427H	180	430269H	55	430345H	56	430421H	57	430506H	59
410-2023	264	41428H	180	430270H	55	430346H	56	430422	57	430507H	59
410-2038	264	41429H	180	430271H	55	430347H	56	430423	57	430508H	59
410-2039	264	41430H	180	430272H	55	430348H	56	430424	57	430509H	59
410-2040	264	41431H	180	430273H	55	430349H	56	430425	57	430510H	59
410-2041	264	41432H	180	430274H	55	430350H	56	430426	57	430511H	59
410-2042	264	41433H	180	430275H	55	430351H	56	430427	57	430512H	59
410-2043	264	41434H	180	430276H	55	430352H	56	430428H	58	430513H	59
410-2111	264	41435H	180	430277H	55	430353H	56	430429H	58	430514H	59
410-2113	264	41450H	180	430278H	55	430354H	56	430430H	58	430515H	59
41200H	178	41451H	180	430279H	55	430355H	56	430431H	58	430516H	60
41201H	178	41452H	180	430280H	55	430356H	56	430432H	58	430517H	60
41202H	178	41453H	180	430281H	55	430357H	56	430433H	58	430518H	60
41203H	178	41454H	180	430282H	55	430358H	56	430434H	58	430519H	60
41204H	178	41455H	180	430283H	55	430359H	56	430435H	58	430520H	60
41205H	178	41456H	180	430284H	55	430360H	56	430436H	58	430521H	60
41206H	178	41457H	180	430285H	55	430361H	56	430437H	58	430522H	60
41207H	178	41505	179	430286H	55	430362H	56	430438H	58	430523H	60
41208H	178	41509	179	430287H	55	430363H	56	430439H	58	430524H	60
41209H	178	41510	179	430288H	55	430364H	56	430440H	58	430525H	60
41210H	178	41513	179	430289H	55	430365H	56	430441H	58	430526H	60
41211H	178	41520H	178	430290H	55	430366H	56	430442H	58	430527H	60
41212H	178	41920H	35	430291H	55	430367H	56	430443H	58	430528H	60
41213H	178	41921H	35	430292H	56	430368H	56	430444H	58	430529H	60
41214H	178	41922H	35	430293H	56	430369H	56	430445H	58	430530H	60
41215H	178	41923H	35	430294H	56	430370H	56	430446H	58	430531H	60
41216H	179	41924H	35	430295H	56	430371H	56	430447H	58	430532H	60
41217H	179	41925H	35	430296H	56	430372H	56	430448H	58	430533H	60
41218H	179	41926H	35	430297H	56	430373H	56	430449H	58	430534H	60
41219H	179	41927H	35	430298H	56	430374H	56	430450H	58	430535H	60
41220H	179	41928H	35	430299H	56	430375H	56	430451H	58	430536H	60
41221H	179	41929H	35	430300H	56	430380H	57	430452H	58	430537H	60
41222H	179	41930H	35	430301H	56	430381H	57	430453H	58	430538H	60
41223H	179	42200H-73	77	430302H	56	430382H	57	430454H	58	430539H	60
41300H	180	42201H-73	77	430303H	56	430383H	57	430455H	58	430540H	59
41301H	180	42202H-73	77	430304H	56	430384H	57	430456H	58	430540H-TF	59
41302H	180	42203H-73	77	430304H-N	60	430385H	57	430457H	58	430540H-TK	60
41303H	180	42204H-73	77	430304H-R	60	430386H	57	430458H	58	430541H	59
41304H	180	430214H	57	430305H	56	430387H	57	430459H	58	430542H	59
41305H	180	430215H	57	430306H	56	430388H	57	430460H	58	430543H	59
41306H	180	430216H	57	430307H	56	430389H	57	430461H	58	430544H	59
41307H	180	430217H	57	430308H	56	430390H	57	430462H	58	430545H	59
41308H	180	430218H	57	430309H	56	430391H	57	430463H	58	430546H	59
41309H	180	430219H	57	430310H	56	430392H	57	430464H	59	430547H	59
41310H	180	430220H	54	430311H	56	430393H	57	430465H	59	430548H	59
41311H	180	430221H	54	430312H	56	430394H	57	430466H	59	430549H	59
41312H	180	430222H	54	430312H-N	60	430395H	57	430467H	59	430550H	59
41313H	180	430223H	54	430312H-R	60	430396H	57	430468H	59	430551H	59
41314H	180	430224H	54	430313H	56	430397H	57	430469H	59	430552H	59
41315H	180	430225H	54	430314H	56	430398H	57	430470H	59	430553H	59
41316H	180	430226H	54	430315H	56	430398H-TF	59	430471H	59	430554H	59
41317H	180	430227H	54	430316H	56	430398H-TK	60	430472H	59	430555H	59
41318H	180	430228H	54	430317H	56	430399H	57	430473H	59	430556H	59
41319H	180	430229H	54	430318H	56	430400H	57	430474H	59	430557H	59
41320H	180	430230H	54	430319H	56	430401H	57	430475H	59	430558H	59
41321H	180	430231H	54	430320H	56	430402H	57	430480H	58	430559H	59
41322H	180	430232H	54	430321H	56	430403H	57	430481H	58	430560H	59
41323H	180	430233H	54	430322H	56	430404H	57	430482H	58	430561H	59
41400H-73	180	430234H	54	430323H	56	430405H	57	430483H	58	430562H	59
41401H-73	180	430235H	54	430324H	56	430406H	57	430484H	58	430563H	59

Artikel-Nr.	Seite	Artikel-Nr.	Seite	Artikel-Nr.	Seite	Artikel-Nr.	Seite	Artikel-Nr.	Seite	Artikel-Nr.	Seite
430564H	58	430758H	71	430911	92	431124H	211	431875H	231	433624	224
430565H	58	430759H	71	430912	92	431125H	211	431876H	231	433653	224
430566H	58	430760H	71	430913	92	431126H	211	431877H	231	433654	224
430567H	58	430761H	71	430914	92	431127H	211	431878	232	433655	224
430568H	58	430762H	71	430915	92	431128H	211	431879	232	433656	224
430569H	58	430763H	71	430916	92	431320	161	431880	232	433660	153
430570H	58	430764H	71	430917	92	431321	161	431881	232	433661	153
430571H	58	430765H	71	430918	92	431786H	233	431882	232	433662	153
430572H	58	430766H	71	430919	92	431787H	233	431887H	233	433664	153
430573H	58	430767H	71	430920	92	431788H	232	431893H	233	433665	153
430574H	58	430768H	71	430921	92	431789H	232	431894H	233	433666	153
430575H	58	430769H	71	430922	92	431790H	232	432016	152	433671	310
430576H	57	430770H	71	430923	92	431791H	232	432017	152	433672	310
430577H	57	430771H	71	430924	92	431792H	232	432018	152	433673	310
430578H	57	430772H	71	430925	92	431793H	232	432019	152	433674	310
430579H	57	430773H	71	430926	93	431801H	231	432027	154, 161	433675	310
430580H	57	430774H	71	430927	93	431802H	231	432028	154, 161	433677	310
430581H	57	430775H	71	430928	93	431803H	231	432029	154, 161	433678	311
430582H	57	430776H	71	430929	93	431804H	231	432030	154, 161	433679	311
430583H	57	430777H	71	430930	93	431805H	231	432033	154, 161	433680	311
430584H	57	430778H	71	430931	93	431806H	231	432034	154, 161	433681	311
430585H	57	430779H	71	430932	93	431807H	231	432035	154, 161	433682	311
430586H	57	430780H	71	430933	93	431808H	231	432036	154, 161	433684	311
430587H	57	430781H	71	430934	93	431809H	231	432039	154, 161	433685	311
430701H	69	430782H	71	430935	93	431810H	231	432040	154, 161	433686	311
430702H	69	430783H	71	430936	93	431811H	231	432041	154, 161	433687	311
430703H	69	430784H	71	430937	93	431817H	231	432042	154, 161	433688	311
430704H	69	430785H	71	430938	93	431818H	231	432045	154, 161	433689	311
430705H	69	430786H	71	430939	93	431819H	231	432046	154, 161	433691	311
430706H	69	430787H	71	430940	93	431820H	231	432047	154, 161	433701	311
430707H	69	430788H	71	430941	93	431821H	231	432048	154, 161	433702	311
430708H	69	430789H	71	430942	93	431822H	231	432658	225	433703	311
430709H	69	430790H	71	430943	93	431823H	231	432659	225	433704	311
430710H	69	430791H	71	430944	93	431824H	231	432663	321	433705	311
430711H	69	430792H	71	430945	93	431825H	231	432664	321	433707	311
430712H	69	430793H	71	430946	93	431826H	231	432666	321	433715	152
430713H	69	430794H	71	430947	93	431827H	231	432805	321	433716	152
430714H	69	430795H	71	430948	93	431828H	231	432805-HKS	154	433725	152
430715H	69	430796H	71	430949	93	431829H	231	432805-IE	154	433730	152
430716H	69	430802H	71	430950	93	431830H	231	432806	321	433731	152
430717H	70	430803H	71	430951	93	431831H	231	432808	321	433732	152
430718H	70	430804H	71	430952	93	431832H	231	432974	321	433733	152
430719H	70	430805H	71	430953	93	431833H	231	432975	321	433734	152
430720H	70	430806H	72	430954	93	431834H	231	432977	321	433735	152
430721H	69	430807H	72	430955	93	431835H	231	433228	321	433760	224
430722H	69	430808H	72	430956	93	431836H	231	433229	321	433761	224
430723H	69	430809H	72	430957	93	431837H	231	433231	321	433762	224
430724H	69	430810H	72	430958	93	431838H	231	433233	321	433763	224
430725H	69	430811H	72	430959	93	431839H	231	433234	321	433764	224
430726H	69	430812H	72	430960	93	431840H	231	433236	321	433765	224
430727H	69	430813H	72	430963	84	431841H	231	433240	321	433766	224
430728H	69	430814H	72	430964	84	431842H	231	433241	321	433767	224
430729H	70	430815H	72	430965	84	431843H	231	433244	321	433770	310
430730H	70	430816H	72	430966	84	431844H	231	433251	321	433771	310
430731H	70	430817H	72	430967	84	431845H	231	433252	321	433772	310
430732H	70	430818H	72	430968	84	431846H	232	433254	321	433773	310
430733H	70	430819H	72	430980H	70	431847H	232	433402	153	433774	310
430734H	70	430820H	72	430981H	70	431848H	232	433403	153	433776	310
430735H	70	430821H	72	430982H	70	431849H	232	433404	153	433778	310
430736H	70	430822H	72	430983H	70	431850H	232	433406	153	433779	310
430737H	70	430823H	72	430984H	70	431851H	232	433407	153	433780	310
430738H	70	430824H	72	430985H	70	431852H	232	433408	153	433781	310
430739H	70	430825H	72	430986H	70	431853H	232	433410	153	433782	310
430740H	70	430826H	72	430987H	70	431854H	232	433411	153	433784	310
430741H	70	430827H	72	430988H	70	431855H	232	433412	153	433786	310
430742H	70	430828H	72	430989H	70	431856H	232	433413	224	433787	310
430743H	70	430829H	72	430990H	70	431857H	232	433414	224	433788	310
430744H	70	430830H	72	430991H	70	431858H	232	433415	224	433789	310
430745H	70	430831H	72	431111H	211	431859H	232	433416	224	433793	310
430746H	70	430832H	72	431112H	211	431860H	232	433417	224	433794	310
430747H	70	430833H	72	431113H	211	431861H	232	433418	224	433795	310
430748H	70	430901	92	431114H	211	431862H	232	433430	153	433796	310
430749H	70	430902	92	431115H	211	431863H	232	433432	153	433797	310
430750H	70	430903	92	431116H	211	431864H	233	433434	153	433799	310
430751H	70	430904	92	431117H	211	431865H	233	433436	153	433802	153
430752H	70	430905	92	431118H	211	431866H	233	433438	153	433803	153
430753H	71	430906	92	431119H	211	431867H	233	433440	152	433804	153
430754H	71	430907	92	431120H	211	431868H	233	433442	152	433806	153
430755H	71	430908	92	431121H	211	431869H	233	433621	224	433807	153
430756H	71	430909	92	431122H	211	431873H	231	433622	224	433808	153
430757H	71	430910	92	431123H	211	431874H	231	433623	224	433817	153

Artikel-Nr.	Seite	Artikel-Nr.	Seite	Artikel-Nr.	Seite	Artikel-Nr.	Seite	Artikel-Nr.	Seite	Artikel-Nr.	Seite
433819	153	45551H	141	552001-18123H	105	552001-85163	373	552002-341550HK	245	552002-86167/68	393
433821	153	45552H	141	552001-18123H	337	552001-85165	373	552002-34170H	431	552002-87160	381
433823	153	45553H	141	552001-18124H	105	552001-85166	373	552002-342550HK	246	552002-87161	381
433841	310	45554H	141	552001-18124H	337	552001-85167/68	373, 377	552002-352010HK	245	552002-87163	381
433842	310	45555H	141	552001-18190	417	552001-85180	375	552002-352050HK	246	552002-87165	381
433843	310	45556H	141	552001-18191	417	552001-85181	375	552002-37088	417	552002-87166	381
433844	310	45557H	141	552001-18192	417	552001-85183	375	552002-37120	419	552002-87167/68	381
433846	310	45600H	141	552001-18193	417	552001-85185	375	552002-37121	419	552002-95160	377
433848	310	45601H	141	552001-18194	417	552001-85186	375	552002-37122	419	552002-95161	377
433850	153	45602H	141	552001-18196	417	552001-85187/88	375	552002-37125	420	552002-95163	377
433851	153	45603H	141	552001-18210H	104, 334	552001-85190	375	552002-37126	420	552002-95165	377
433852	153	45604H	141	552001-18213H	105	552001-85191	375	552002-37127	420	552002-95166	377
433854	153	45605H	141	552001-18213H	337	552001-85193	375	552002-37180	419	552002-95180	377
433855	153	45606H	141	552001-18214H	105	552001-85195	375	552002-37182	419	552002-95181	377
433856	153	45607H	141	552001-18214H	337	552001-85196	375	552002-37183	420	552002-95183	377
433891	310	47050H	187	552001-34070H	431	552001-85197/98	375	552002-37185	420	552002-95185	377
433893	310	47051H	187	552001-34120H	431	552001-86160	393	552002-37186	417	552002-95186	377
434216	160	47052H	187	552001-34125H	431	552001-86161	393	552002-37188	419	552002-550044	373
434217	160	47053H	187	552001-34126H	431	552001-86162	393	552002-37189	420	552002-550065	385
434218	160	47054H	187	552001-34127H	431	552001-86163	393	552002-41550HK	104, 334	552002-555102	385
434219	160	47075H	187	552001-34128H	431	552001-86165	393	552002-42550HK	104, 334	552002-555142	385
434220	160	47076H	187	552001-341550HK	245	552001-86167/68	393	552002-55100	385	552002-555182	373
434221	160	47077H	187	552001-34170H	431	552001-87160	381	552002-55101	385	552002-585162	373
434222	160	47078H	187	552001-342550HK	246	552001-87161	381	552002-55105	385	552002-585182	375
434223	160	47079H	187	552001-352010HK	245	552001-87163	381	552002-55106	385	552002-585192	375
434224	160	47250H	187	552001-352050HK	246	552001-87165	381	552002-55107/08	385	552002-587162	381
434225	160	47251H	187	552001-37088	417	552001-87166	381	552002-55140	385	552002-595162	377
434226	160	47252H	187	552001-37120	419	552001-87167/68	381	552002-55141	385	552002-595182	377
434227	160	47253H	187	552001-37121	419	552001-95160	377	552002-55143	385	552003-12020H	104, 334
434228	160	47254H	187	552001-37122	419	552001-95161	377	552002-55145	385	552003-12050H	104, 334
434229	160	47255H	187	552001-37125	420	552001-95163	377	552002-55146	385	552003-18120H	104, 334
434230	160	47256H	187	552001-37126	420	552001-95165	377	552002-55147/48	385	552003-18210H	104, 334
434231	160	47257H	187	552001-37127	420	552001-95166	377	552002-55180	373	552003-341550HK	245
434232	160	47258H	187	552001-37180	419	552001-95180	377	552002-55181	373	552003-342550HK	246
434233	160	47259H	187	552001-37182	419	552001-95181	377	552002-55185	373	552003-352010HK	245
434234	160	47275H	187	552001-37183	420	552001-95183	377	552002-55186	373	552003-352050HK	246
434235	160	47276H	187	552001-37185	420	552001-95185	377	552002-55187/88	373, 377	552003-41550HK	104, 334
434236	160	47277H	187	552001-37186	417	552001-95186	377	552002-55440	412	552003-42550HK	104, 334
434237	160	47278H	187	552001-37188	419	552001-550044	373	552002-55442	412	552004-12020H	104, 334
434238	160	47279H	187	552001-37189	420	552001-550065	385	552002-55445	412	552004-12050H	104, 334
434239	160	47280H	187	552001-41550HK	104, 334	552001-55102	385	552002-55446	412	552004-18120H	104, 334
434240	160	47281H	187	552001-42550HK	104, 334	552001-555142	385	552002-55460	413	552004-18210H	104, 334
434241	160	47282H	187	552001-55100	385	552001-555182	373	552002-55462	413	552004-341550HK	245
434248	161	47283H	187	552001-55101	385	552001-585162	373	552002-55465	413	552004-342550HK	246
434249	161	47284H	187	552001-55105	385	552001-585182	375	552002-55466	413	552004-352010HK	245
434250	161	47650H	187	552001-55106	385	552001-585192	375	552002-55563	432	552004-352050HK	246
434251	161	47651H	187	552001-55107/08	385	552001-587162	381	552002-55565	432	552004-41550HK	104, 334
434252	161	47652H	187	552001-55140	385	552001-595162	377	552002-55566	432	552004-42550HK	104, 334
434253	161	47653H	187	552001-55141	385	552001-595182	377	552002-55567	432	552005-12020H	104, 334
434326	160	47654H	187	552001-55143	385	552002-12020H	104, 334	552002-55800	413	552005-12050H	104, 334
434328	160	47655H	187	552001-55145	385	552002-12023H	105	552002-55802	413	552005-18120H	104, 334
434330	160	47656H	187	552001-55146	385	552002-12023H	337	552002-55805	413	552005-18210H	104, 334
434332	160	47657H	187	552001-55147/48	385	552002-12050H	104, 334	552002-55806	413	552005-341550HK	245
434334	160	47658H	187	552001-55180	373	552002-12053H	105	552002-55850	393	552005-342550HK	246
434336	160	47659H	187	552001-55181	373	552002-12053H	337	552002-55852	393	552005-352010HK	245
434342	161	509-18120	87	552001-55185	373	552002-17112	417	552002-55855	393	552005-352050HK	246
434344	161	531910-148	81	552001-55186	373	552002-17190	417	552002-55856	393	552005-41550HK	104, 334
434414	310	531911-148	81	552001-55187/88	373, 377	552002-17191	417	552002-55857/58	393	552005-42550HK	104, 334
434415	310	532212-800	81	552001-55440	412	552002-17193	417	552002-85160	373	552006-12020H	104, 334
434416	310	532230-800	81	552001-55442	412	552002-17194	417	552002-85161	373	552006-12050H	104, 334
434417	310	533434-198	82	552001-55445	412	552002-17196	417	552002-85163	373	552006-18120H	104, 334
434418	310	533436-198	82	552001-55446	412	552002-18120H	104, 334	552002-85165	373	552006-18210H	104, 334
434432	311	538020-400	81	552001-55460	413	552002-18123H	105, 337	552002-85166	373	552006-341550HK	245
434433	311	538021-400	81	552001-55462	413	552002-18124H	105, 337	552002-85167/68	373, 377	552006-342550HK	246
434434	311	538260-400	81	552001-55465	413	552002-18190	417	552002-85180	375	552006-352010HK	245
434435	311	538261-400	81	552001-55466	413	552002-18191	417	552002-85181	375	552006-352050HK	246
434436	311	538280-400	81	552001-55563	432	552002-18192	417	552002-85183	375	552006-41550HK	104, 334
434438	311	538281-400	81	552001-55565	432	552002-18193	417	552002-85185	375	552006-42550HK	104, 334
434445	310	552001-12020H	104, 334	552001-55566	432	552002-18194	417	552002-85186	375	552007-12020H	104, 334
434482	224	552001-12023H	105	552001-55567	432	552002-18196	417	552002-85187/88	375	552007-12050H	104, 334
434483	224	552001-12023H	337	552001-55800	413	552002-18210H	104, 334	552002-85190	375	552007-18120H	104, 334
434484	224	552001-12050H	104, 334	552001-55802	413	552002-18213H	105	552002-85191	375	552007-18210H	104, 334
434485	224	552001-12053H	105	552001-55805	413	552002-18213H	337	552002-85193	375	552007-341550HK	245
434976	160	552001-12053H	337	552001-55806	413	552002-18214H	105	552002-85195	375	552007-342550HK	246
434977	160	552001-17112	417	552001-55850	393	552002-18214H	337	552002-85196	375	552007-352010HK	245
434978	160	552001-17190	417	552001-55852	393	552002-34070H	431	552002-85197/98	375	552007-352050HK	246
434979	160	552001-17191	417	552001-55855	393	552002-34120H	431	552002-86160	393	552007-41550HK	104, 334
434980	161	552001-17193	417	552001-55856	393	552002-34125H	431	552002-86161	393	552007-42550HK	104, 334
434981	161	552001-17194	417	552001-55857/58	393	552002-34126H	431	552002-86162	393	552008-12020H	104, 334
436698	310	552001-17196	417	552001-85160	373	552002-34127H	431	552002-86163	393	552008-12050H	104, 334
45550H	141	552001-18120H	104, 334	552001-85161	373	552002-34128H	431	552002-86165	393	552008-18120H	104, 334

Artikel-Nr.	Seite	Artikel-Nr.	Seite	Artikel-Nr.	Seite	Artikel-Nr.	Seite	Artikel-Nr.	Seite	Artikel-Nr.	Seite
552008-18210H	104, 334	552016-341550HK	245	552024-342550HK	248	552032-352010HK	247	552040-352050HK	248	552119-41550HK	104, 335
552008-341550HK	245	552016-342550HK	246	552024-352010HK	247	552032-352050HK	248	552040-41550HK	107, 335	552119-42550HK	104, 335
552008-342550HK	246	552016-352010HK	245	552024-352050HK	248	552032-41550HK	106, 335	552040-42550HK	107, 335	553001-32020H	111, 339
552008-352010HK	245	552016-352050HK	246	552024-41550HK	106, 335	552032-42550HK	106, 335	552112-12020H	104, 336	553001-32025H	113, 341
552008-352050HK	246	552016-41550HK	106, 334	552024-42550HK	106, 335	552033-12020H	107, 335	552112-12050H	104, 336	553001-32027H	113, 341
552008-41550HK	104, 334	552016-42550HK	106, 334	552025-12020H	106, 335	552033-12050H	107, 335	552112-18120H	104, 336	553001-32050H	111, 339
552008-42550HK	104, 334	552017-12020H	106, 334	552025-12050H	106, 335	552033-18120H	107, 335	552112-18210H	104, 336	553001-32055H	113, 341
552009-12020H	104, 334	552017-12050H	106, 334	552025-18120H	106, 335	552033-18210H	107, 335	552112-341550HK	245	553001-32057H	113, 341
552009-12050H	104, 334	552017-18120H	106, 334	552025-18210H	106, 335	552033-341550HK	247	552112-342550HK	246	553001-34070H	431
552009-18120H	104, 334	552017-18210H	106, 334	552025-341550HK	247	552033-342550HK	248	552112-352010HK	245	553001-34120H	431
552009-18210H	104, 334	552017-341550HK	247	552025-342550HK	248	552033-352010HK	247	552112-352050HK	246	553001-34125H	431
552009-341550HK	245	552017-342550HK	248	552025-352010HK	247	552033-352050HK	248	552112-41550HK	104, 336	553001-34126H	431
552009-342550HK	246	552017-352010HK	247	552025-352050HK	248	552033-41550HK	107, 335	552112-42550HK	104, 336	553001-34127H	431
552009-352010HK	245	552017-352050HK	248	552025-41550HK	106, 335	552033-42550HK	107, 335	552113-12020H	104, 336	553001-34128H	431
552009-352050HK	246	552017-41550HK	106, 334	552025-42550HK	106, 335	552034-12020H	107, 335	552113-12050H	104, 336	553001-34146H	425
552009-41550HK	104, 334	552017-42550HK	106, 334	552026-12020H	106, 335	552034-12050H	107, 335	552113-18120H	104, 336	553001-34147H	425
552009-42550HK	104, 334	552018-12020H	106, 334	552026-12050H	106, 335	552034-18120H	107, 335	552113-18210H	104, 336	553001-34148H	425
552010-12020H	104, 334	552018-12050H	106, 334	552026-18120H	106, 335	552034-18210H	107, 335	552113-341550HK	245	553001-34149H	425
552010-12050H	104, 334	552018-18120H	106, 334	552026-18210H	106, 335	552034-341550HK	247	552113-342550HK	246	553001-34156H	425
552010-18120H	104, 334	552018-18210H	106, 334	552026-341550HK	247	552034-342550HK	248	552113-352010HK	245	553001-34157H	425
552010-18210H	104, 334	552018-341550HK	247	552026-342550HK	248	552034-352010HK	247	552113-352050HK	246	553001-34158H	425
552010-341550HK	245	552018-342550HK	248	552026-352010HK	247	552034-352050HK	248	552113-41550HK	104, 336	553001-34159H	425
552010-342550HK	246	552018-352010HK	247	552026-352050HK	248	552034-41550HK	107, 335	552113-42550HK	104, 336	553001-34306	431
552010-352010HK	245	552018-352050HK	248	552026-41550HK	106, 335	552034-42550HK	107, 335	552114-12020H	104, 336	553001-34307	431
552010-352050HK	246	552018-41550HK	106, 334	552026-42550HK	106, 335	552035-12020H	107, 335	552114-12050H	104, 336	553001-34308	431
552010-41550HK	104, 334	552018-42550HK	106, 334	552027-12020H	106, 335	552035-12050H	107, 335	552114-18120H	104, 336	553001-34309	431
552010-42550HK	104, 334	552019-12020H	106, 334	552027-12050H	106, 335	552035-18120H	107, 335	552114-18210H	104, 336	553001-37120	419
552011-12020H	104, 334	552019-12050H	106, 334	552027-18120H	106, 335	552035-18210H	107, 335	552114-341550HK	245	553001-37121	419
552011-12050H	104, 334	552019-18120H	106, 334	552027-18210H	106, 335	552035-341550HK	247	552114-342550HK	246	553001-37122	419
552011-18120H	104, 334	552019-18210H	106, 334	552027-341550HK	247	552035-342550HK	248	552114-352010HK	245	553001-37125	420
552011-18210H	104, 334	552019-341550HK	247	552027-342550HK	248	552035-352010HK	247	552114-352050HK	246	553001-37126	420
552011-341550HK	245	552019-342550HK	248	552027-352010HK	247	552035-352050HK	248	552114-41550HK	104, 336	553001-37127	420
552011-342550HK	246	552019-352010HK	247	552027-352050HK	248	552035-41550HK	107, 335	552114-42550HK	104, 336	553001-37180	419
552011-352010HK	245	552019-352050HK	248	552027-41550HK	106, 335	552035-42550HK	107, 335	552115-12020H	104, 336	553001-37182	419
552011-352050HK	246	552019-41550HK	106, 334	552027-42550HK	106, 335	552036-12020H	107, 335	552115-12050H	104, 336	553001-37183	420
552011-41550HK	104, 334	552019-42550HK	106, 334	552028-12020H	106, 335	552036-12050H	107, 335	552115-18120H	104, 336	553001-37185	420
552011-42550HK	104, 334	552020-12020H	106, 334	552028-12050H	106, 335	552036-18120H	107, 335	552115-18210H	104, 336	553001-37188	419
552012-12020H	104, 334	552020-12050H	106, 334	552028-18120H	106, 335	552036-18210H	107, 335	552115-341550HK	245	553001-37189	420
552012-12050H	104, 334	552020-18120H	106, 334	552028-18210H	106, 335	552036-341550HK	247	552115-342550HK	246	553001-38110H	111, 339
552012-18120H	104, 334	552020-18210H	106, 334	552028-341550HK	247	552036-342550HK	248	552115-352010HK	245	553001-38115H	113, 341
552012-18210H	104, 334	552020-341550HK	247	552028-342550HK	248	552036-352010HK	247	552115-352050HK	246	553001-38116H	113, 341
552012-341550HK	245	552020-342550HK	248	552028-352010HK	247	552036-352050HK	248	552115-41550HK	104, 336	553001-38117H	113, 341
552012-342550HK	246	552020-352010HK	247	552028-352050HK	248	552036-41550HK	107, 335	552115-42550HK	104, 336	553001-38118H	113, 341
552012-352010HK	245	552020-352050HK	248	552028-41550HK	106, 335	552036-42550HK	107, 335	552116-12020H	104, 336	553001-53150	368
552012-352050HK	246	552020-41550HK	106, 334	552028-42550HK	106, 335	552037-12020H	107, 335	552116-12050H	104, 336	553001-53151	368
552012-41550HK	104, 334	552020-42550HK	106, 334	552029-12020H	106, 335	552037-12050H	107, 335	552116-18120H	104, 336	553001-53159	368
552012-42550HK	104, 334	552021-12020H	106, 335	552029-12050H	106, 335	552037-18120H	107, 335	552116-18210H	104, 336	553001-55520	413
552013-12020H	106, 334	552021-12050H	106, 335	552029-18120H	106, 335	552037-18210H	107, 335	552116-341550HK	245	553001-55522	413
552013-12050H	106, 334	552021-18120H	106, 335	552029-18210H	106, 335	552037-341550HK	247	552116-342550HK	246	553001-55526	413
552013-18120H	106, 334	552021-18210H	106, 335	552029-341550HK	247	552037-342550HK	248	552116-352010HK	245	553001-55720	362
552013-18210H	106, 334	552021-341550HK	247	552029-342550HK	248	552037-352010HK	247	552116-352050HK	246	553001-55722	362
552013-341550HK	245	552021-342550HK	248	552029-352010HK	247	552037-352050HK	248	552116-41550HK	104, 336	553001-55725	362
552013-342550HK	246	552021-352010HK	247	552029-352050HK	248	552037-41550HK	107, 335	552116-42550HK	104, 336	553001-55729	362
552013-352010HK	245	552021-352050HK	248	552029-41550HK	106, 335	552037-42550HK	107, 335	552117-12020H	104, 335	553001-55730	361
552013-352050HK	246	552021-41550HK	106, 335	552029-42550HK	106, 335	552038-12020H	107, 335	552117-12050H	104, 335	553001-55732	361
552013-41550HK	106, 334	552021-42550HK	106, 335	552030-12020H	106, 335	552038-12050H	107, 335	552117-18120H	104, 335	553001-55735	361
552013-42550HK	106, 334	552022-12020H	106, 335	552030-12050H	106, 335	552038-18120H	107, 335	552117-18210H	104, 335	553001-55736	361
552014-12020H	106, 334	552022-12050H	106, 335	552030-18120H	106, 335	552038-18210H	107, 335	552117-341550HK	245	553001-55737	361
552014-12050H	106, 334	552022-18120H	106, 335	552030-18210H	106, 335	552038-341550HK	247	552117-342550HK	246	553001-55738	361
552014-18120H	106, 334	552022-18210H	106, 335	552030-341550HK	247	552038-342550HK	248	552117-352010HK	245	553001-55740	363
552014-18210H	106, 334	552022-341550HK	247	552030-342550HK	248	552038-352010HK	247	552117-352050HK	246	553001-55742	363
552014-341550HK	245	552022-342550HK	248	552030-352010HK	247	552038-352050HK	248	552117-41550HK	104, 335	553001-55745	363
552014-342550HK	246	552022-352010HK	247	552030-352050HK	248	552038-41550HK	107, 335	552117-42550HK	104, 335	553001-55749	363
552014-352010HK	245	552022-352050HK	248	552030-41550HK	106, 335	552038-42550HK	107, 335	552118-12020H	104, 335	553001-55760	362
552014-352050HK	246	552022-41550HK	106, 335	552030-42550HK	106, 335	552039-12020H	107, 335	552118-12050H	104, 335	553001-55762	362
552014-41550HK	106, 334	552022-42550HK	106, 335	552031-12020H	106, 335	552039-12050H	107, 335	552118-18120H	104, 335	553001-55765	362
552014-42550HK	106, 334	552023-12020H	106, 335	552031-12050H	106, 335	552039-18120H	107, 335	552118-18210H	104, 335	553001-55766	362
552015-12020H	106, 334	552023-12050H	106, 335	552031-18120H	106, 335	552039-18210H	107, 335	552118-341550HK	245	553001-55770	362
552015-12050H	106, 334	552023-18120H	106, 335	552031-1821							

Artikel-Nr.	Seite	Artikel-Nr.	Seite	Artikel-Nr.	Seite	Artikel-Nr.	Seite	Artikel-Nr.	Seite	Artikel-Nr.	Seite
553001-55845	368	553002-55770	362	553034-32050H	111, 339	554002-37183	420	554111-37180	419	555040-32020H	122, 348
553001-59420	361	553002-55775	362	553034-38110H	111, 339	554002-37185	420	554111-37182	419	555040-32050H	122, 348
553001-59422	361	553002-55820	367	553035-32020H	111, 339	554002-37188	419	554111-37183	420	555040-32080H	123, 349
553001-59425	361	553002-55821	367	553035-32050H	111, 339	554002-37189	420	554111-37185	420	555040-32100H	123, 349
553001-59426	361	553002-55822	367	553035-38110H	111, 339	554002-38110H	115, 343	554111-37188	419	555040-34090H	123, 349
553001-59427	361	553002-55825	367	553036-32020H	111, 339	554002-38115H	116, 344	554111-37189	420	555040-38110H	122, 348
553001-59428	361	553002-55826	367	553036-32050H	111, 339	554002-38116H	116, 344	554111-38110H	115, 343	555040-42550HK	122, 348
553001-59620	427	553002-55830	367	553036-38110H	111, 339	554002-38117H	116, 344	554111-38115H	116, 344	555040-42580HK	123, 349
553001-59627	427	553002-55831	367	553037-32020H	112, 340	554002-38118H	116, 344	554111-38116H	116, 344	555113-27180H	124, 350
553001-59628	427	553002-55832	367	553037-32050H	112, 340	554003-32020H	115, 343	554111-38117H	116, 344	555113-27181H	124, 350
553001-59629	427	553002-55835	367	553037-38110H	112, 340	554003-32050H	115, 343	554111-38118H	116, 344	555113-27182H	124, 350
553001-59630	427	553002-55836	367	553038-32020H	112, 340	554003-38110H	115, 343	554113-32020H	115, 343	555113-32020H	122, 348
553001-59637	427	553002-55840	368	553038-32050H	112, 340	554004-32020H	115, 343	554113-32050H	115, 343	555113-32050H	122, 348
553001-59638	427	553002-55841	368	553038-38110H	112, 340	554004-32050H	115, 343	554113-38110H	115, 343	555113-32080H	123, 349
553001-59639	427	553002-55845	368	553039-32020H	112, 340	554004-38110H	115, 343	554117-32020H	115, 343	555113-32100H	123, 349
553002-32020H	111, 339	553002-59420	361	553039-32050H	112, 340	554006-32020H	115, 343	554117-32050H	115, 343	555113-34090H	123, 349
553002-32025H	113, 341	553002-59422	361	553039-38110H	112, 340	554006-32050H	115, 343	554117-38110H	115, 343	555113-38110H	122, 348
553002-32027H	113, 341	553002-59425	361	553040-32020H	112, 340	554006-38110H	115, 343	554118-32020H	115, 343	555113-42550HK	122, 348
553002-32050H	111, 339	553002-59426	361	553040-32050H	112, 340	554007-32020H	115, 343	554118-32050H	115, 343	555113-42580HK	123, 349
553002-32055H	113, 341	553002-59427	361	553040-38110H	112, 340	554007-32050H	115, 343	554118-38110H	115, 343	555117-27180H	124, 350
553002-32057H	113, 341	553002-59428	361	553112-32020H	112, 340	554007-38110H	115, 343	554119-32020H	115, 343	555117-27181H	124, 350
553002-34070H	431	553002-59620	427	553112-32050H	112, 340	554008-32020H	115, 343	554119-32050H	115, 343	555117-27182H	124, 350
553002-34120H	431	553002-59627	427	553112-38110H	112, 340	554008-32050H	115, 343	554119-38110H	115, 343	555117-32020H	122, 348
553002-34125H	431	553002-59628	427	553113-32020H	112, 340	554008-38110H	115, 343	555023-27180H	124, 350	555117-32050H	122, 348
553002-34126H	431	553002-59629	427	553113-32050H	112, 340	554010-32020H	115, 343	555023-27181H	124, 350	555117-32080H	123, 349
553002-34127H	431	553002-59630	427	553113-38110H	112, 340	554010-32050H	115, 343	555023-27182H	124, 350	555117-32100H	123, 349
553002-34128H	431	553002-59637	427	553114-32020H	112, 340	554010-38110H	115, 343	555023-32020H	122, 348	555117-34090H	123, 349
553002-34146H	425	553002-59638	427	553114-32050H	112, 340	554011-32020H	115, 343	555023-32050H	122, 348	555117-38110H	122, 348
553002-34147H	425	553002-59639	427	553114-38110H	112, 340	554011-32050H	115, 343	555023-32080H	123, 349	555117-42550HK	122, 348
553002-34148H	425	553003-32020H	111, 339	553115-32020H	112, 340	554011-38110H	115, 343	555023-32100H	123, 349	555117-42580HK	123, 349
553002-34149H	425	553003-32050H	111, 339	553115-32050H	112, 340	554014-32020H	115, 343	555023-34090H	123, 349	555118-27180H	124, 350
553002-34156H	425	553003-38110H	111, 339	553115-38110H	112, 340	554014-32050H	115, 343	555023-38110H	122, 348	555118-27181H	124, 350
553002-34157H	425	553004-32020H	111, 339	553116-32020H	112, 340	554014-38110H	115, 343	555023-42550HK	122, 348	555118-27182H	124, 350
553002-34158H	425	553004-32050H	111, 339	553116-32050H	112, 340	554015-32020H	115, 343	555023-42580HK	123, 349	555118-32020H	122, 348
553002-34159H	425	553004-38110H	111, 339	553116-38110H	112, 340	554015-32050H	115, 343	555035-27180H	124, 350	555118-32050H	122, 348
553002-34306	431	553006-32020H	111, 339	553117-32020H	112, 340	554015-38110H	115, 343	555035-27181H	124, 350	555118-32080H	123, 349
553002-34307	431	553006-32050H	111, 339	553117-32050H	112, 340	554016-32020H	115, 343	555035-27182H	124, 350	555118-32100H	123, 349
553002-34308	431	553006-38110H	111, 339	553117-38110H	112, 340	554016-32050H	115, 343	555035-32020H	122, 348	555118-34090H	123, 349
553002-34309	431	553007-32020H	111, 339	553118-32020H	112, 340	554016-38110H	115, 343	555035-32050H	122, 348	555118-38110H	122, 348
553002-37120	419	553007-32050H	111, 339	553118-32050H	112, 340	554019-32020H	115, 343	555035-32080H	123, 349	555118-42550HK	122, 348
553002-37121	419	553007-38110H	111, 339	553118-38110H	112, 340	554019-32050H	115, 343	555035-32100H	123, 349	555118-42580HK	123, 349
553002-37122	419	553008-32020H	111, 339	553119-32020H	112, 340	554019-38110H	115, 343	555035-34090H	123, 349	563-18120	87
553002-37125	420	553008-32050H	111, 339	553119-32050H	112, 340	554023-32020H	115, 343	555035-38110H	122, 348	5716-17112	417
553002-37126	420	553008-38110H	111, 339	553119-38110H	112, 340	554023-32050H	115, 343	555035-42550HK	122, 348	5716-17190	417
553002-37127	420	553010-32020H	111, 339	554001-32020H	115, 343	554023-38110H	115, 343	555035-42580HK	123, 349	5716-17191	417
553002-37180	419	553010-32050H	111, 339	554001-32025H	116, 344	554026-32020H	115, 343	555036-27180H	124, 350	5716-17193	417
553002-37182	419	553010-38110H	111, 339	554001-32027H	116, 344	554026-32050H	115, 343	555036-27181H	124, 350	5716-17194	417
553002-37183	420	553011-32020H	111, 339	554001-32050H	115, 343	554026-38110H	115, 343	555036-27182H	124, 350	5716-17196	417
553002-37185	420	553011-32050H	111, 339	554001-32055H	116, 344	554027-32020H	115, 343	555036-32020H	122, 348	5716-18190	417
553002-37188	419	553011-38110H	111, 339	554001-32057H	116, 344	554027-32050H	115, 343	555036-32050H	122, 348	5716-18191	417
553002-37189	420	553014-32020H	111, 339	554001-37120	419	554027-38110H	115, 343	555036-32080H	123, 349	5716-18192	417
553002-38110H	111, 339	553014-32050H	111, 339	554001-37121	419	554031-32020H	115, 343	555036-32100H	123, 349	5716-18193	417
553002-38115H	113, 341	553014-38110H	111, 339	554001-37122	419	554031-32050H	115, 343	555036-34090H	123, 349	5716-18194	417
553002-38116H	113, 341	553015-32020H	111, 339	554001-37125	420	554031-38110H	115, 343	555036-38110H	122, 348	5716-18196	417
553002-38117H	113, 341	553015-32050H	111, 339	554001-37126	420	554035-32020H	115, 343	555036-42550HK	122, 348	5716-34126H	431
553002-38118H	113, 341	553015-38110H	111, 339	554001-37127	420	554035-32050H	115, 343	555036-42580HK	123, 349	5716-341550HK	245
553002-53150	368	553016-32020H	111, 339	554001-37180	419	554035-38110H	115, 343	555038-27180H	124, 350	5716-342550HK	246
553002-53151	368	553016-32050H	111, 339	554001-37182	419	554036-32020H	115, 343	555038-27181H	124, 350	5716-352010HK	245
553002-53159	368	553016-38110H	111, 339	554001-37183	420	554036-32050H	115, 343	555038-27182H	124, 350	5716-352050HK	246
553002-53320	434	553018-32020H	111, 339	554001-37185	420	554036-38110H	115, 343	555038-32020H	122, 348	5716-37088	417
553002-53321	434	553018-32050H	111, 339	554001-37188	419	554038-32020H	115, 343	555038-32050H	122, 348	5716-37120	419
553002-53322	434	553018-38110H	111, 339	554001-37189	420	554038-32050H	115, 343	555038-32080H	123, 349	5716-37121	419
553002-53323	434	553019-32020H	111, 339	554001-38110H	115, 343	554038-38110H	115, 343	555038-32100H	123, 349	5716-37122	419
553002-55720	362	553019-32050H	111, 339	554001-38115H	116, 344	554039-32020H	115, 343	555038-34090H	123, 349	5716-37125	420
553002-55722	362	553019-38110H	111, 339	554001-38116H	116, 344	554039-32050H	115, 343	555038-38110H	122, 348	5716-37126	420
553002-55725	362	553023-32020H	111, 339	554001-38117H	116, 344	554039-38110H	115, 343	555038-42550HK	122, 348	5716-37127	420
553002-55729	362	553023-32050H	111, 339	554001-38118H	116, 344	554040-32020H	115, 343	555038-42580HK	123, 349	5716-37180	419
553002-55730	361	553023-38110H	111, 339	554002-32020H	115, 343	554040-32050H	115, 343	555039-27180H	124, 350	5716-37182	419
553002-55732	361	553026-32020H	111,								

Artikel-Nr.	Seite	Artikel-Nr.	Seite	Artikel-Nr.	Seite	Artikel-Nr.	Seite	Artikel-Nr.	Seite	Artikel-Nr.	Seite
5716-55143	385	5716i-12020H	104, 334	610-2039	264	700-37122	419	700-87167/68	381	701-2020H	247
5716-55145	385	5716i-12023H	105, 337	610-2040	264	700-37125	420	700-95160	377	701-2021H	247
5716-55146	385	5716i-12050H	104, 334	610-2041	264	700-37126	420	700-95161	377	701-2022H	247
5716-55147/48	385	5716i-12053H	105, 337	610-2042	264	700-37127	420	700-95163	377	701-2023H	247
5716-55180	373	5716i-18120H	104, 334	610-2043	264	700-37180	419	700-95165	377	701-2024H	247
5716-55181	373	5716i-18123H	105, 337	610-2111	264	700-37182	419	700-95166	377	701-2025H	247
5716-55185	373	5716i-18124H	105, 337	610-2113	264	700-37183	420	700-95180	377	701-2026H	247
5716-55186	373	5716i-18210H	104, 334	620241-070	85	700-37185	420	700-95181	377	701-2027H	247
5716-55187/88	373, 377	5716i-18213H	105, 337	620241-072	85	700-37186	417	700-95183	377	701-2028H	247
5716-55440	412	5716i-18214H	105, 337	620241-073	85	700-37188	419	700-95185	377	701-2029H	247
5716-55442	412	5716i-34070H	431	620241-075	85	700-37189	420	700-95186	377	701-2030H	247
5716-55445	412	5716i-34120H	431	620245-072	85	700-38110	87	700-550044	373	701-2031H	247
5716-55446	412	5716i-34125H	431	620249-070	85	700-55100	385	700-550065	385	701-2032H	247
5716-55460	413	5716i-34127H	431	620249-072	85	700-55101	385	700-555102	385	701-2033H	247
5716-55462	413	5716i-34128H	431	620249-073	85	700-55105	385	700-555142	385	701-2034H	247
5716-55465	413	5716i-34170H	431	620249-075	85	700-55106	385	700-555182	373	701-2035H	247
5716-55466	413	5716i-42550HK	104, 334	620290-070	85	700-55107/08	385	700-585162	373	701-2036H	247
5716-55563	432	590-37040-21	145	620290-072	85	700-55140	385	700-585182	375	701-2037H	247
5716-55565	432	590-37042-21	145	620290-073	85	700-55141	385	700-585192	375	701-2038H	247
5716-55566	432	590-37043-21	145	620290-075	85	700-55143	385	700-587162	381	701-2039H	247
5716-55567	432	590-37044-21	145	620296-070	85	700-55145	385	700-595162	377	701-2040H	247
5716-55800	413	600334-070	86	620296-072	85	700-55146	385	700-595182	377	701-2111H	245
5716-55802	413	600334-072	86	620296-075	85	700-55147/48	385	700i-12020H	104, 334	701-2112H	245
5716-55805	413	600334-073	86	620450-070	85	700-55180	373	700i-12023H	105	701-2113H	245
5716-55806	413	600334-075	86	620450-072	85	700-55181	373	700i-12023H	337	701-2114H	245
5716-55850	393	600355-103-70	97	620450-073	85	700-55185	373	700i-12050H	104, 334	701-2115H	245
5716-55852	393	600355-106-70	97	620450-075	85	700-55186	373	700i-12053H	105, 337	701-2116H	245
5716-55855	393	600356-103-70	97	620460-070	85	700-55187/88	373, 377	700i-18120H	104, 334	701-2117H	245
5716-55856	393	600356-106-70	97	620460-072	85	700-55440	412	700i-18123H	105	701-2118H	245
5716-55857/58	393	600357-103-70	97	620460-073	85	700-55442	412	700i-18123H	337	701-2119H	245
5716-85160	373	600357-106-70	97	620460-075	85	700-55445	412	700i-18124H	105, 337	701-2120H	245
5716-85161	373	600384-070	86	620470-070	85	700-55446	412	700i-18210H	104, 334	701-34020	418
5716-85163	373	600384-072	86	620470-072	85	700-55460	413	700i-18213H	105	701-37011	433
5716-85165	373	600384-073	86	620470-073	85	700-55462	413	700i-18213H	337	701-37015	433
5716-85166	373	600384-075	86	620470-075	85	700-55465	413	700i-18214H	105	701-37017	433
5716-85167/68	373, 377	600416-070	86	620480-072	85	700-55466	413	700i-18214H	337	701-37018	433
5716-85180	375	600416-072	86	620480-075	85	700-55563	432	700i-34070H	431	701-37021	418
5716-85181	375	600416-073	86	620490-072	85	700-55565	432	700i-34120H	431	701-37023	418
5716-85183	375	600416-075	86	620490-075	85	700-55566	432	700i-34125H	431	701-37024	418
5716-85185	375	600417-070	86	620510-070	85	700-55567	432	700i-34126H	431	701-37031	433
5716-85186	375	600417-072	86	620510-072	85	700-55800	413	700i-34127H	431	701-37035	433
5716-85187/88	375	600417-073	86	620510-073	85	700-55802	413	700i-34128H	431	701-37080	418
5716-85190	375	600417-075	86	620510-075	85	700-55805	413	700i-341550HK	245	701-37081	418
5716-85191	375	600420-070	86	620805-504	84	700-55806	413	700i-34170H	431	701-37082	418
5716-85193	375	600420-072	86	620805-505	84	700-55850	393	700i-342550HK	246	701-37088	417
5716-85195	375	600420-073	86	620806-504	84	700-55852	393	700i-352010HK	245	701-37090	418
5716-85196	375	600420-075	86	620806-505	84	700-55855	393	700i-352050HK	246	701-37091	418
5716-85197/98	375	600430-070-71	86	620811-504	84	700-55856	393	700i-41550HK	104, 334	701-37092	418
5716-86160	393	600430-072-71	86	620811-505	84	700-55857/58	393	700i-42550HK	104, 334	701-37120	419
5716-86161	393	600430-075-71	86	623060-070	86	700-59680	433	701-17112	417	701-37121	419
5716-86162	393	600442-070	86	623060-072	86	700-59681	433	701-17190	417	701-37122	419
5716-86163	393	600442-072	86	623060-073	86	700-59685	433	701-17191	417	701-37125	420
5716-86165	393	600442-073	86	623060-075	86	700-85160	373	701-17193	417	701-37126	420
5716-86167/68	393	600442-075	86	700-17112	417	700-85161	373	701-17194	417	701-37127	420
5716-87160	381	600443-070	86	700-17190	417	700-85163	373	701-17196	417	701-37180	419
5716-87161	381	600443-072	86	700-17191	417	700-85165	373	701-18120	87	701-37182	419
5716-87163	381	600443-073	86	700-17193	417	700-85166	373	701-18190	417	701-37183	420
5716-87165	381	600443-075	86	700-17194	417	700-85167/68	373, 377	701-18191	417	701-37185	420
5716-87166	381	600450-070	86	700-17196	417	700-85180	375	701-18192	417	701-37186	417
5716-87167/68	381	600450-072	86	700-18120	87	700-85181	375	701-18193	417	701-37188	419
5716-95160	377	600450-073	86	700-18190	417	700-85183	375	701-18194	417	701-37189	420
5716-95161	377	600450-075	86	700-18191	417	700-85185	375	701-18196	417	701-38110	87
5716-95163	377	600499-070	86	700-18192	417	700-85186	375	701-2001H	245	701-44025	418
5716-95165	377	600499-072	86	700-18193	417	700-85187/88	375	701-2002H	245	701-44026	418
5716-95166	377	600499-073	86	700-18194	417	700-85190	375	701-2003H	245	701-55100	385
5716-95180	377	600499-075	86	700-18196	417	700-85191	375	701-2004H	245	701-55101	385
5716-95181	377	600859-504	84	700-37011	433	700-85193	375	701-2005H	245	701-55105	385
5716-95183	377	600859-505	84	700-37015	433	700-85195	375	701-2006H	245	701-55106	385
5716-95185	377	600864-504	84	700-37017	433	700-85196	375	701-2007H	245	701-55107/08	385
5716-95186	377	600864-505	84	700-37018	433	700-85197/98	375	701-2008H	245	701-55140	385
5716-550044	373	601500-070-71	85	700-37021	418	700-86160	393	701-2009H	245	701-55141	385
5716-550065	385	601500-072-71	85	700-37023	418	700-86161	393	701-2010H	245	701-55143	385
5716-555102	385	601500-075-71	85	700-37024	418	700-86162	393	701-2011H	245	701-55145	385
5716-555142	385	601550-070-71	85	700-37031	433	700-86163	393	701-2012H	245	701-55146	385
5716-555182	373	601550-072-71	85	700-37035	433	700-86165	393	701-2013H	245	701-55147/48	385
5716-585162	373	601550-075-71	85	700-37080	418	700-86167/68	393	701-2014H	245	701-55180	373
5716-585182	375	610-2008	264	700-37081	418	700-87160	381	701-2015H	245	701-55181	373
5716-585192	375	610-2016	264	700-37082	418	700-87161	381	701-2016H	245	701-55185	373
5716-587162	381	610-2023	264	700-37088	417	700-87163	381	701-2017H	247	701-55186	373
5716-595162	377	610-2033	264	700-37120	419	700-87165	381	701-2018H	247	701-55187/88	373, 377
5716-595182	377	610-2038	264	700-37121	419	700-87166	381	701-2019H	247	701-55440	412

Artikel-Nr.	Seite	Artikel-Nr.	Seite	Artikel-Nr.	Seite	Artikel-Nr.	Seite	Artikel-Nr.	Seite	Artikel-Nr.	Seite
701-55442	412	701i-18123H	337	703-2011H	245	705-2040H	247	715-2011H	246	720-2036H	248
701-55445	412	701i-18124H	105, 337	703-2012H	245	705-2111H	245	715-2012H	246	720-2037H	248
701-55446	412	701i-18210H	104, 334	703-2013H	245	705-2112H	245	715-2013H	246	720-2038H	248
701-55460	413	701i-18213H	105	703-2014H	245	705-2113H	245	715-2014H	246	720-2039H	248
701-55462	413	701i-18213H	337	703-2015H	245	705-2114H	245	715-2015H	246	720-2040H	248
701-55465	413	701i-18214H	105	703-2016H	245	705-2115H	245	715-2016H	246	720-2111H	246
701-55466	413	701i-18214H	337	703-2017H	247	705-2116H	245	715-2017H	248	720-2112H	246
701-55563	432	701i-34070H	431	703-2018H	247	705-2117H	245	715-2018H	248	720-2113H	246
701-55565	432	701i-34120H	431	703-2019H	247	705-2118H	245	715-2019H	248	720-2114H	246
701-55566	432	701i-34125H	431	703-2020H	247	705-2119H	245	715-2020H	248	720-2115H	246
701-55567	432	701i-34126H	431	703-2021H	247	705-2120H	245	715-2021H	248	720-2116H	246
701-55800	413	701i-34127H	431	703-2022H	247	705-2121H	245	715-2022H	248	720-2117H	246
701-55802	413	701i-34128H	431	703-2023H	247	710-2001H	245	715-2023H	248	720-2118H	246
701-55805	413	701i-341550HK	245	703-2024H	247	710-2002H	245	715-2024H	248	720-2119H	246
701-55806	413	701i-34170H	431	703-2025H	247	710-2003H	245	715-2025H	248	720-2120H	246
701-55850	393	701i-342550HK	246	703-2026H	247	710-2004H	245	715-2026H	248	730-2001H	246
701-55852	393	701i-352010HK	245	703-2027H	247	710-2005H	245	715-2027H	248	730-2002H	246
701-55855	393	701i-352050HK	246	703-2028H	247	710-2006H	245	715-2028H	248	730-2003H	246
701-55856	393	701i-41550HK	104, 334	703-2029H	247	710-2007H	245	715-2029H	248	730-2004H	246
701-55857/58	393	701i-42550HK	104, 334	703-2030H	247	710-2008H	245	715-2030H	248	730-2005H	246
701-59680	433	702-2001H	245	703-2031H	247	710-2009H	245	715-2031H	248	730-2006H	246
701-59681	433	702-2002H	245	703-2032H	247	710-2010H	245	715-2032H	248	730-2007H	246
701-59685	433	702-2003H	245	703-2033H	247	710-2011H	245	715-2033H	248	730-2008H	246
701-85160	373	702-2004H	245	703-2034H	247	710-2012H	245	715-2034H	248	730-2009H	246
701-85161	373	702-2005H	245	703-2035H	247	710-2013H	245	715-2035H	248	730-2010H	246
701-85163	373	702-2006H	245	703-2036H	247	710-2014H	245	715-2036H	248	730-2011H	246
701-85165	373	702-2007H	245	703-2037H	247	710-2015H	245	715-2037H	248	730-2012H	246
701-85166	373	702-2008H	245	703-2038H	247	710-2016H	245	715-2038H	248	730-2013H	246
701-85167/68	373, 377	702-2009H	245	703-2039H	247	710-2017H	247	715-2039H	248	730-2014H	246
701-85180	375	702-2010H	245	703-2040H	247	710-2018H	247	715-2040H	248	730-2015H	246
701-85181	375	702-2011H	245	703-2111H	245	710-2019H	247	715-2111H	246	730-2016H	246
701-85183	375	702-2012H	245	703-2112H	245	710-2020H	247	715-2112H	246	730-2017H	248
701-85185	375	702-2013H	245	703-2113H	245	710-2021H	247	715-2113H	246	730-2018H	248
701-85186	375	702-2014H	245	703-2114H	245	710-2022H	247	715-2114H	246	730-2019H	248
701-85187/88	375	702-2015H	245	703-2115H	245	710-2023H	247	715-2115H	246	730-2020H	248
701-85190	375	702-2016H	245	703-2116H	245	710-2024H	247	715-2116H	246	730-2021H	248
701-85191	375	702-2017H	247	703-2117H	245	710-2025H	247	715-2117H	246	730-2022H	248
701-85193	375	702-2018H	247	703-2118H	245	710-2026H	247	715-2118H	246	730-2023H	248
701-85195	375	702-2019H	247	703-2119H	245	710-2027H	247	715-2119H	246	730-2024H	248
701-85196	375	702-2020H	247	703-2120H	245	710-2028H	247	715-2120H	246	730-2025H	248
701-85197/98	375	702-2021H	247	703-2121H	245	710-2029H	247	717i-12020H	107, 336	730-2026H	248
701-86160	393	702-2022H	247	703-38110	87	710-2030H	247	717i-12050H	107, 336	730-2027H	248
701-86161	393	702-2023H	247	705-2001H	245	710-2031H	247	717i-18120H	107, 336	730-2028H	248
701-86162	393	702-2024H	247	705-2002H	245	710-2032H	247	717i-18210H	107, 336	730-2029H	248
701-86163	393	702-2025H	247	705-2003H	245	710-2033H	247	717i-41550HK	107, 336	730-2030H	248
701-86165	393	702-2026H	247	705-2004H	245	710-2034H	247	717i-42550HK	107, 336	730-2031H	248
701-86167/68	393	702-2027H	247	705-2005H	245	710-2035H	247	720-2001H	246	730-2032H	248
701-87160	381	702-2028H	247	705-2006H	245	710-2036H	247	720-2002H	246	730-2033H	248
701-87161	381	702-2029H	247	705-2007H	245	710-2037H	247	720-2003H	246	730-2034H	248
701-87163	381	702-2030H	247	705-2008H	245	710-2038H	247	720-2004H	246	730-2035H	248
701-87165	381	702-2031H	247	705-2009H	245	710-2039H	247	720-2005H	246	730-2036H	248
701-87166	381	702-2032H	247	705-2010H	245	710-2040H	247	720-2006H	246	730-2037H	248
701-87167/68	381	702-2033H	247	705-2011H	245	710-2111H	245	720-2007H	246	730-2038H	248
701-95160	377	702-2034H	247	705-2012H	245	710-2112H	245	720-2008H	246	730-2039H	248
701-95161	377	702-2035H	247	705-2013H	245	710-2113H	245	720-2009H	246	730-2040H	248
701-95163	377	702-2036H	247	705-2014H	245	710-2114H	245	720-2010H	246	730-2111H	246
701-95165	377	702-2037H	247	705-2015H	245	710-2115H	245	720-2011H	246	730-2112H	246
701-95166	377	702-2038H	247	705-2016H	245	710-2116H	245	720-2012H	246	730-2113H	246
701-95180	377	702-2039H	247	705-2017H	247	710-2117H	245	720-2013H	246	730-2114H	246
701-95181	377	702-2040H	247	705-2018H	247	710-2118H	245	720-2014H	246	730-2115H	246
701-95183	377	702-2111H	245	705-2019H	247	710-2119H	245	720-2015H	246	730-2116H	246
701-95185	377	702-2112H	245	705-2020H	247	710-2120H	245	720-2016H	246	730-2117H	246
701-95186	377	702-2113H	245	705-2021H	247	710-2121H	245	720-2017H	248	730-2118H	246
701-550044	373	702-2114H	245	705-2022H	247	710-2504H	249	720-2018H	248	730-2119H	246
701-550065	385	702-2115H	245	705-2023H	247	710-2508H	249	720-2019H	248	730-2120H	246
701-555102	385	702-2116H	245	705-2024H	247	710-2512H	249	720-2020H	248	730-2121H	246
701-555142	385	702-2117H	245	705-2025H	247	710-2516H	249	720-2021H	248	732-18120	87
701-555182	373	702-2118H	245	705-2026H	247	710-2520H	249	720-2022H	248	740-2001H	246
701-585162	373	702-2119H	245	705-2027H	247	710-2524H	249	720-2023H	248	740-2002H	246
701-585182	375	702-2120H	245	705-2028H	247	711-18120	87	720-2024H	248	740-2003H	246
701-585192	375	703-18120	87	705-2029H	247	71152-8110	87	720-2025H	248	740-2004H	246
701-587162	381	703-2001H	245	705-2030H	247	715-2001H	246	720-2026H	248	740-2005H	246
701-595162	377	703-2002H	245	705-2031H	247	715-2002H	246	720-2027H	248	740-2006H	246
701-595182	377	703-2003H	245	705-2032H	247	715-2003H	246	720-2028H	248	740-2007H	246
701i-12020H	104, 334	703-2004H	245	705-2033H	247	715-2004H	246	720-2029H	248	740-2008H	246
701i-12023H	105	703-2005H	245	705-2034H	247	715-2005H	246	720-2030H	248	740-2009H	246
701i-12023H	337	703-2006H	245	705-2035H	247	715-2006H	246	720-2031H	248	740-2010H	246
701i-12050H	104, 334	703-2007H	245	705-2036H	247	715-2007H	246	720-2032H	248	740-2011H	246
701i-12053H	105, 337	703-2008H	245	705-2037H	247	715-2008H	246	720-2033H	248	740-2012H	246
701i-18120H	104, 334	703-2009H	245	705-2038H	247	715-2009H	246	720-2034H	248	740-2013H	246
701i-18123H	105	703-2010H	245	705-2039H	247	715-2010H	246	720-2035H	248	740-2014H	246

Artikel-Nr.	Seite	Artikel-Nr.	Seite	Artikel-Nr.	Seite	Artikel-Nr.	Seite	Artikel-Nr.	Seite	Artikel-Nr.	Seite
740-2015H	246	760-2019H	248	764-2034H	259	810-2023	264	8454-342557HK	278	8464-342550HK	277
740-2016H	246	760-2020H	248	764-2036H	259	810-2033	264	8454-B200HK	277	8464-342580HK	277
740-2017H	248	760-2021H	248	764-2037H	259	810-2038	264	8454-B600HK	277	8464-38110H	277
740-2018H	248	760-2022H	248	764-2040H	259	810-2039	264	8454-B611HK	278	8464-53150	279, 368
740-2019H	248	760-2023H	248	764-2111H	257	810-2040	264	8454-B612HK	278	8464-53151	279, 368
740-2020H	248	760-2024H	248	764-2113H	257	810-2041	264	8454-B775HK	278	8464-53159	279, 368
740-2021H	248	760-2025H	248	764-2115H	257	810-2042	264	8454-B776HK	278	8464-53320	279
740-2022H	248	760-2026H	248	764-2117H	257	810-2043	264	8460-32020H	277	8464-53321	279
740-2023H	248	760-2027H	248	764-2118H	257	810-2111	264	8460-332050HK	277	8464-53322	279
740-2024H	248	760-2028H	248	764-2119H	257	810-2113	264	8460-34090H	277	8464-53323	279
740-2025H	248	760-2029H	248	764-2120H	257	811-2038	264	8460-342030H	277	8464-7161H	277
740-2026H	248	760-2030H	248	77i-32020H	112, 340	811-2042	264	8460-342550HK	277	8464-B200HK	277
740-2027H	248	760-2031H	248	77i-32050H	112, 340	811-2111	264	8460-342580HK	277	851-1010	216
740-2028H	248	760-2032H	248	77i-38110H	112, 340	811-2113	264	8460-38110H	277	851-1020	216
740-2029H	248	760-2033H	248	785-2001H	257	812-2038	264	8460-53150	279, 368	851-1030	216
740-2030H	248	760-2034H	248	785-2002H	257	812-2042	264	8460-53151	279, 368	851-1630	216
740-2031H	248	760-2035H	248	785-2003H	257	812-2111	264	8460-53159	279, 368	851-2110	131
740-2032H	248	760-2036H	248	785-2004H	257	812-2113	264	8460-53320	279	851-2541	218
740-2033H	248	760-2037H	248	785-2006H	257	813-2038	264	8460-53321	279	851-4822	217
740-2034H	248	760-2038H	248	785-2007H	257	813-2042	264	8460-53322	279	851-4825	217
740-2035H	248	760-2039H	248	785-2008H	257	813-2111	264	8460-53323	279	851-9063	217
740-2036H	248	760-2040H	248	785-2011H	257	813-2113	264	8460-61061HK	279	851-9066	217
740-2037H	248	760-2111H	246	785-2015H	257	815-2008	265	8460-7161H	277	851-9330	218
740-2038H	248	760-2112H	246	785-2016H	257	815-2023	265	8460-B200HK	277	851-9335	218
740-2039H	248	760-2113H	246	785-2019H	259	815-2038	265	8461-32020H	277	851-9337	218
740-2040H	248	760-2114H	246	785-2023H	259	815-2039	265	8461-332050HK	277	851-9338	218
740-2111H	246	760-2115H	246	785-2027H	259	815-2040	265	8461-34090H	277	851-9822	218
740-2112H	246	760-2116H	246	785-2031H	259	815-2041	265	8461-342030H	277	854-1010	216
740-2113H	246	760-2117H	246	785-2034H	259	815-2042	265	8461-342550HK	277	854-1020	216
740-2114H	246	760-2118H	246	785-2036H	259	815-2043	265	8461-342580HK	277	854-1030	216
740-2115H	246	760-2119H	246	785-2037H	259	815-2111	265	8461-38110H	277	854-1630	216
740-2116H	246	760-2120H	246	785-2040H	259	815-2113	265	8461-53150	279, 368	854-2110	131
740-2117H	246	760-2121H	246	785-2111H	257	81i-32020H	115, 343	8461-53151	279, 368	854-2541	218
740-2118H	246	761-2001H	250, 257	785-2113H	257	81i-32025H	116, 344	8461-53159	279, 368	854-4822	217
740-2119H	246	761-2002H	250, 257	785-2115H	257	81i-32027H	116, 344	8461-53320	279	854-4825	217
740-2120H	246	761-2003H	250, 257	785-2117H	257	81i-32050H	115, 343	8461-53321	279	854-9063	217
759-2001H	250, 257	761-2004H	250, 257	785-2118H	257	81i-32055H	116, 344	8461-53322	279	854-9066	217
759-2002H	250, 257	761-2006H	250, 257	785-2119H	257	81i-32057H	116, 344	8461-53323	279	854-9330	218
759-2003H	250, 257	761-2007H	250, 257	785-2120H	257	81i-38110H	115, 343	8461-61061HK	279	854-9335	218
759-2004H	250, 257	761-2008H	250, 257	786-2001H	257	81i-38115H	116, 344	8461-7161H	277	854-9337	218
759-2006H	250, 257	761-2011H	250, 257	786-2002H	257	81i-38116H	116, 344	8461-B200HK	277	854-9338	218
759-2007H	250, 257	761-2015H	250, 257	786-2003H	257	81i-38117H	116, 344	8462-32020H	277	854-9822	218
759-2008H	250, 257	761-2016H	250, 257	786-2004H	257	81i-38118H	116, 344	8462-332050HK	277	855-1010	216
759-2011H	250, 257	761-2019H	250, 259	786-2006H	257	8450-332050HK	277	8462-34090H	277	855-1020	216
759-2015H	250, 257	761-2023H	250, 259	786-2007H	257	8450-342550HK	277	8462-342030H	277	855-1030	216
759-2016H	250, 257	761-2027H	250, 259	786-2008H	257	8450-342557HK	278	8462-342550HK	277	855-1630	216
759-2019H	250, 259	761-2031H	250, 259	786-2011H	257	8450-B200HK	277	8462-342580HK	277	855-2110	131
759-2023H	250, 259	761-2034H	250, 259	786-2015H	257	8450-B600HK	277	8462-38110H	277	855-2541	218
759-2027H	250, 259	761-2036H	250, 259	786-2016H	257	8450-B611HK	278	8462-53150	279, 368	855-4822	217
759-2031H	250, 259	761-2037H	250, 259	786-2019H	259	8450-B612HK	278	8462-53151	279, 368	855-4825	217
759-2034H	250, 259	761-2040H	250, 259	786-2023H	259	8450-B775HK	278	8462-53159	279, 368	855-9063	217
759-2036H	250, 259	761-2111H	250, 257	786-2027H	259	8450-B776HK	278	8462-53320	279	855-9066	217
759-2037H	250, 259	761-2113H	250, 257	786-2031H	259	8451-332050HK	277	8462-53321	279	855-9330	218
759-2040H	250, 259	761-2115H	250, 257	786-2034H	259	8451-342550HK	277	8462-53322	279	855-9335	218
759-2111H	250, 257	761-2117H	250, 257	786-2036H	259	8451-342557HK	278	8462-53323	279	855-9337	218
759-2113H	250, 257	761-2118H	250, 257	786-2037H	259	8451-B200HK	277	8462-53510H	441	855-9338	218
759-2115H	250, 257	761-2119H	250, 257	786-2040H	259	8451-B600HK	277	8462-53511H	441	855-9822	218
759-2117H	250, 257	761-2120H	250, 257	786-2111H	257	8451-B611HK	278	8462-53512H	441	856-1010	216
759-2118H	250, 257	763-2003H	250	786-2113H	257	8451-B612HK	278	8462-61061HK	279	856-1020	216
759-2119H	250, 257	763-2034H	250	786-2115H	257	8451-B775HK	278	8462-7161H	277	856-1030	216
759-2120H	250, 257	763-2036H	250	786-2117H	257	8451-B776HK	278	8462-B200HK	277	856-1630	216
75917-8110	87	763-2037H	250	786-2118H	257	8452-332050HK	277	8463-32020H	277	856-2110	131
75918-8110	87	763-2040H	250	786-2119H	257	8452-342550HK	277	8463-332050HK	277	856-2541	218
760-2001H	246	763-2111H	250	786-2120H	257	8452-342557HK	278	8463-34090H	277	856-4822	217
760-2002H	246	763-2115H	250	78i-32020H	115, 343	8452-B200HK	277	8463-342030H	277	856-4825	217
760-2003H	246	763-2118H	250	78i-32050H	115, 343	8452-B600HK	277	8463-342550HK	277	856-9063	217
760-2004H	246	763-2120H	250	78i-38110H	115, 343	8452-B611HK	278	8463-342580HK	277	856-9066	217
760-2005H	246	764-2001H	257	81-37120	419	8452-B612HK	278	8463-38110H	277	856-9330	218
760-2006H	246	764-2002H	257	81-37121	419	8452-B775HK	278	8463-53150	279, 368	856-9335	218
760-2007H	246	764-2003H	257	81-37122	419	8452-B776HK	278	8463-53151	279, 368	856-9337	218
760-2008H	246	764-2004H	257	81-37125	420	8453-332050HK	277	8463-53159	279, 368	856-9338	218
760-2009H	246	764-2006H	257	81-37126	420	8453-342550HK	277	8463-53320	279	856-9822	218
760-2010H	246	764-2007H	257	81-37127	420	8453-342557HK	278	8463-53321	279	864-2008	265
760-2011H	246	764-2008H	257	81-37180	419	8453-B200HK	277	8463-53322	279	864-2016	265
760-2012H	246	764-2011H	257	81-37182	419	8453-B600HK	277	8463-53323	279	864-2023	265
760-2013H	246	764-2015H	257	81-37183	420	8453-B611HK	278	8463-7161H	277	864-2033	265
760-2014H	246	764-2016H	257	81-37185	420	8453-B612HK	278	8463-B200HK	277	864-2038	265
760-2015H	246	764-2019H	259	81-37188	419	8453-B775HK	278	8464-32020H	277	864-2039	265
760-2016H	246	764-2023H	259	81-37189	420	8453-B776HK	278	8464-332050HK	277	864-2040	265
760-2017H	248	764-2027H	259	810-2008	264	8454-332050HK	277	8464-34090H	277	864-2041	265
760-2018H	248	764-2031H	259	810-2016	264	8454-342550HK	277	8464-342030H	277	864-2042	265

Artikel-Nr.	Seite	Artikel-Nr.	Seite	Artikel-Nr.	Seite	Artikel-Nr.	Seite	Artikel-Nr.	Seite	Artikel-Nr.	Seite
864-2043	265	886-2113	265	900039-55456	412	900567-59422	361	900671-34137H	430	902-2117H	256
864-2111	265	900-1100	165	900044-34146H	425	900567-59425	361	900671-34138H	430	902-2118H	256
864-2113	265	900-1110	165	900044-34147H	425	900567-59426	361	900671-34139H	430	902-2119H	256
8701H	192	900-1160	165	900044-34148H	425	900567-59427	361	900671-34166H	430	902-2120H	256
8703H	192	900-17112	417	900044-34149H	425	900567-59428	361	900671-34167H	430	9020-2120	131
8704H	192	900-17190	417	900044-34156H	425	900567-59620	427	900671-34168H	430	9020-2240	131
8707H	192	900-17191	417	900044-34157H	425	900567-59627	427	900671-34169H	430	9020-2250	131
8709	192	900-17193	417	900044-34158H	425	900567-59628	427	900672-32059	432	9020-2270	131
8721H	192	900-17194	417	900044-34159H	425	900567-59629	427	900672-38119	432	9020-2280	131
8723H	192	900-17196	417	900044-55720	362	900567-59630	427	900673-32059	432	9020-9220	132
8724H	192	900-18190	417	900044-55722	362	900567-59637	427	900673-38119	432	9021-2120	131
8727H	192	900-18191	417	900044-55725	362	900567-59638	427	900674-55450	412	9021-2240	131
8751H	192	900-18192	417	900044-55729	362	900567-59639	427	900674-55452	412	9021-2250	131
8753H	192	900-18193	417	900044-55730	361	900567-510002	432	900674-55455	412	9021-2270	131
8754H	192	900-18194	417	900044-55732	361	900568-34136H	430	900674-55456	412	9021-2280	131
8757H	192	900-18196	417	900044-55735	361	900568-34137H	430	900713-342555HK	278	9021-2521	132
8759H	192	900-34100	424	900044-55736	361	900568-34138H	430	900714-342555HK	278	9021-2720	132
8800-B200HK	284	900-34105	424	900044-55737	361	900568-34139H	430	900719-342555HK	278	9021-2721	132
8800-B600HK	284	900-34106	424	900044-55738	361	900568-34166H	430	900725-342555HK	278	9021-4822	132
8800-B611HK	284	900-34107	424	900044-55740	363	900568-34167H	430	900726-342555HK	278	9021-9220	132
8800-B670HK	284	900-34108	424	900044-55742	363	900568-34168H	430	901-37080	125, 351	9022-2120	131
8801-B200HK	284	900-34109	424	900044-55745	363	900568-34169H	430	901-37081	125, 351	9022-2240	131
8801-B600HK	284	900-34110	424	900044-55749	363	900588-34146H	425	901-37082	125, 351	9022-2250	131
8801-B611HK	284	900-34115	424	900044-55760	362	900588-34147H	425	901i-27180H	124, 350	9022-2270	131
8801-B670HK	284	900-34116	424	900044-55762	362	900588-34148H	425	901i-27181H	124, 350	9022-2280	131
8802-B200HK	284	900-34117	424	900044-55765	362	900588-34149H	425	901i-27182H	124, 350	9022-2521	132
8802-B600HK	284	900-34118	424	900044-55766	362	900588-34156H	425	901i-32020H	122, 348	9022-2720	132
8802-B611HK	284	900-34119	424	900044-55770	362	900588-34157H	425	901i-32050H	122, 348	9022-2721	132
8802-B670HK	284	900-37088	417	900044-55775	362	900588-34158H	425	901i-32080H	123, 349	9022-4822	132
8803-B200HK	284	900-37120	419	900044-59420	361	900588-34159H	425	901i-32100H	123, 349	9022-9220	132
8803-B600HK	284	900-37121	419	900044-59422	361	900588-55720	362	901i-34020H	125, 351	9023-2120	131
8803-B611HK	284	900-37122	419	900044-59425	361	900588-55722	362	901i-34090H	123, 349	9023-2240	131
8803-B670HK	284	900-37125	420	900044-59426	361	900588-55725	362	901i-38110H	122, 348	9023-2250	131
8804-B200HK	284	900-37126	420	900044-59427	361	900588-55729	362	901i-42550HK	122, 348	9023-2270	131
8804-B600HK	284	900-37127	420	900044-59428	361	900588-55730	361	901i-42580HK	123, 349	9023-2280	131
8804-B611HK	284	900-37150	432	900044-59620	427	900588-55732	361	902-2001H	256	9023-9220	132
8804-B670HK	284	900-37155	432	900044-59627	427	900588-55735	361	902-2002H	256	9024-2120	131
8810-342030H	284	900-37180	419	900044-59628	427	900588-55736	361	902-2003H	256	9024-2240	131
8810-7161H	284	900-37182	419	900044-59629	427	900588-55737	361	902-2004H	256	9024-2250	131
8810-B200HK	284	900-37183	420	900044-59630	427	900588-55738	361	902-2005H	256	9024-2270	131
8810-B600HK	284	900-37185	420	900044-59637	427	900588-55740	363	902-2006H	256	9024-2280	131
8811-342030H	284	900-37186	417	900044-59638	427	900588-55742	363	902-2007H	256	9024-9220	132
8811-7161H	284	900-37188	419	900044-59639	427	900588-55745	363	902-2008H	256	9025-2120	131
8811-B200HK	284	900-37189	420	900044-510002	432	900588-55749	363	902-2009H	256	9025-2240	131
8811-B600HK	284	900-4030	165	900464-55450	412	900588-55760	362	902-2010H	256	9025-2250	131
8812-342030H	284	900-4033	165	900464-55452	412	900588-55762	362	902-2011H	256	9025-2270	131
8812-7161H	284	900-4034	165	900464-55455	412	900588-55765	362	902-2012H	256	9025-2280	131
8812-B200HK	284	900-4822	165	900464-55456	412	900588-55766	362	902-2013H	256	9025-9220	132
8812-B600HK	284	900-53130	426	900566-55450	412	900588-55770	362	902-2014H	256	9026-2120	131
8813-342030H	284	900-53135	426	900566-55452	412	900588-55775	362	902-2015H	256	9026-2240	131
8813-7161H	284	900-53136	426	900566-55455	412	900588-59420	361	902-2016H	256	9026-2250	131
8813-B200HK	284	900-53137	426	900566-55456	412	900588-59422	361	902-2017H	258	9026-2270	131
8813-B600HK	284	900-53138	426	900567-34146H	425	900588-59425	361	902-2018H	258	9026-2280	131
8814-342030H	284	900-53139	426	900567-34147H	425	900588-59426	361	902-2019H	258	9026-2521	132
8814-7161H	284	900-53150	368	900567-34148H	425	900588-59427	361	902-2020H	258	9026-2720	132
8814-B200HK	284	900-53151	368	900567-34149H	425	900588-59428	361	902-2021H	258	9026-2721	132
8814-B600HK	284	900-53159	368	900567-34156H	425	900588-59620	427	902-2022H	258	9026-4822	132
8823-B700HK	290	900-53190	426	900567-34157H	425	900588-59627	427	902-2023H	258	9026-9220	132
8823-B710HK	290	900-53195	426	900567-34158H	425	900588-59628	427	902-2024H	258	9027-2120	131
8823-B729HK	290	900-53196	426	900567-34159H	425	900588-59629	427	902-2025H	258	9027-2240	131
8823-B755HK	290	900-53197	426	900567-55720	362	900588-59630	427	902-2026H	258	9027-2250	131
8823-B770HK	290	900-53198	426	900567-55722	362	900588-59637	427	902-2027H	258	9027-2270	131
885-2008	265	900-53199	426	900567-55725	362	900588-59638	427	902-2028H	258	9027-2280	131
885-2023	265	900-54420	434	900567-55729	362	900588-59639	427	902-2029H	258	9027-2521	132
885-2038	265	900-54421	434	900567-55730	361	900615-55450	412	902-2030H	258	9027-2720	132
885-2039	265	900-54422	434	900567-55732	361	900615-55452	412	902-2031H	258	9027-2721	132
885-2040	265	900-54423	434	900567-55735	361	900615-55455	412	902-2032H	258	9027-4822	132
885-2041	265	900-55440	412	900567-55736	361	900615-55456	412	902-2033H	258	9027-9220	132
885-2042	265	900-55442	412	900567-55737	361	900634-34136H	430	902-2034H	258	902R-1100	165
885-2043	265	900-55445	412	900567-55738	361	900634-34137H	430	902-2035H	258	902R-1110	165
885-2111	265	900-55446	412	900567-55740	363	900634-34138H	430	902-2036H	258	902R-1160	165
885-2113	265	900-55750	363	900567-55742	363	900634-34139H	430	902-2037H	258	902R-4030	165
886-2008	265	900-55752	363	900567-55745	363	900634-34166H	430	902-2038H	258	902R-4033	165
886-2023	265	900-55755	363	900567-55749	363	900634-34167H	430	902-2039H	258	902R-4034	165
886-2038	265	900-55759	363	900567-55760	362	900634-34168H	430	902-2040H	258	902R-4822	165
886-2039	265	900-55840	368	900567-55762	362	900634-34169H	430	902-2111H	256	902R-54420	434
886-2040	265	900-55841	368	900567-55765	362	900644-32059	432	902-2112H	256	902R-54421	434
886-2041	265	900-55845	368	900567-55766	362	900644-38119	432	902-2113H	256	902R-54422	434
886-2042	265	900039-55450	412	900567-55770	362	900659-32059	432	902-2114H	256	902R-54423	434
886-2043	265	900039-55452	412	900567-55775	362	900659-38119	432	902-2115H	256	9030-2120	131
886-2111	265	900039-55455	412	900567-59420	361	900671-34136H	430	902-2116H	256	9030-2240	131

Artikel-Nr.	Seite	Artikel-Nr.	Seite	Artikel-Nr.	Seite	Artikel-Nr.	Seite	Artikel-Nr.	Seite
9030-2250	131	905-2114H	256	910-2024H	258	920-2010H	256	950-9066	217
9030-2270	131	905-2115H	256	910-2025H	258	920-2011H	256	951-1100	216
9030-2280	131	905-2116H	256	910-2026H	258	920-2012H	256	951-1620	216
9030-2521	132	905-2117H	256	910-2027H	258	920-2013H	256	951-2110	131
9030-2720	132	905-2118H	256	910-2028H	258	920-2014H	256	951-2120	131
9030-2721	132	905-2119H	256	910-2029H	258	920-2015H	256	951-4822	217
9030-4822	132	905-2120H	256	910-2030H	258	920-2016H	256	951-9066	217
9030-9220	132	91-34306	431	910-2031H	258	920-2017H	258	958-1010	216
9031-2120	131	91-34307	431	910-2032H	258	920-2018H	258	958-1630	216
9031-2240	131	91-34308	431	910-2033H	258	920-2019H	258	958-4822	217
9031-2250	131	91-34309	431	910-2034H	258	920-2020H	258	958-9066	217
9031-2270	131	91-37120	419	910-2035H	258	920-2021H	258	958-9330	218
9031-2280	131	91-37121	419	910-2036H	258	920-2022H	258	958-9335	218
9031-2521	132	91-37122	419	910-2037H	258	920-2023H	258	958-9337	218
9031-2720	132	91-37125	420	910-2038H	258	920-2024H	258	958-9338	218
9031-2721	132	91-37126	420	910-2039H	258	920-2025H	258	964-1100	165
9031-4822	132	91-37127	420	910-2040H	258	920-2026H	258	964-1110	165
9031-9220	132	91-37150	432	910-2111H	256	920-2027H	258	964-1160	165
9032-2120	131	91-37155	432	910-2112H	256	920-2028H	258	F-190	393
9032-2240	131	91-37180	419	910-2113H	256	920-2029H	258	R10000	443
9032-2250	131	91-37182	419	910-2114H	256	920-2030H	258	R10100	443
9032-2270	131	91-37183	420	910-2115H	256	920-2031H	258	R20000	443
9032-2280	131	91-37185	420	910-2116H	256	920-2032H	258	R20100	443
9032-2521	132	91-37188	419	910-2117H	256	920-2033H	258	R21000	443
9032-2720	132	91-37189	420	910-2118H	256	920-2034H	258	R21100	443
9032-2721	132	91-53130	426	910-2119H	256	920-2035H	258	R50100	443
9032-4822	132	91-53135	426	910-2120H	256	920-2036H	258	R51100	443
9032-9220	132	91-53136	426	918-37080	125, 351	920-2037H	258		
9033-2120	131	91-53137	426	918-37081	125, 351	920-2038H	258		
9033-2240	131	91-53138	426	918-37082	125, 351	920-2039H	258		
9033-2250	131	91-53139	426	918i-27180H	124, 350	920-2040H	258		
9033-2270	131	91-53150	368	918i-27181H	124, 350	920-2111H	256		
9033-2280	131	91-53151	368	918i-27182H	124, 350	920-2112H	256		
9033-2521	132	91-53159	368	918i-32020H	122, 348	920-2113H	256		
9033-2720	132	91-53190	426	918i-32050H	122, 348	920-2114H	256		
9033-2721	132	91-53195	426	918i-32080H	123, 349	920-2115H	256		
9033-4822	132	91-53196	426	918i-32100H	123, 349	920-2116H	256		
9033-9220	132	91-53197	426	918i-34020H	125, 351	920-2117H	256		
905-2001H	256	91-53198	426	918i-34090H	123, 349	920-2118H	256		
905-2002H	256	91-53199	426	918i-34306H	125, 351	920-2119H	256		
905-2003H	256	91-53320	434	918i-38110H	122, 348	920-2120H	256		
905-2004H	256	91-53321	434	918i-42550HK	122, 348	926-37080	125, 351		
905-2005H	256	91-53322	434	918i-42580HK	123, 349	926-37081	125, 351		
905-2006H	256	91-53323	434	91i-32020H	111, 339	926-37082	125, 351		
905-2007H	256	91-54420	434	91i-32025H	113, 341	926i-27180H	124, 350		
905-2008H	256	91-54421	434	91i-32027H	113, 341	926i-27181H	124, 350		
905-2009H	256	91-54422	434	91i-32050H	111, 339	926i-27182H	124, 350		
905-2010H	256	91-54423	434	91i-32055H	113, 341	926i-32020H	122, 348		
905-2011H	256	91-55520	413	91i-32057H	113, 341	926i-32050H	122, 348		
905-2012H	256	91-55522	413	91i-34070H	431	926i-32080H	123, 349		
905-2013H	256	91-55526	413	91i-34100H	424	926i-32100H	123, 349		
905-2014H	256	91-55750	363	91i-34105H	424	926i-34020H	125, 351		
905-2015H	256	91-55752	363	91i-34106H	424	926i-34090H	123, 349		
905-2016H	256	91-55755	363	91i-34107H	424	926i-38110H	122, 348		
905-2017H	258	91-55759	363	91i-34108H	424	926i-42550HK	122, 348		
905-2018H	258	91-55840	368	91i-34109H	424	926i-42580HK	123, 349		
905-2019H	258	91-55841	368	91i-34110H	424	929R-1100	165		
905-2020H	258	91-55845	368	91i-34115H	424	929R-1110	165		
905-2021H	258	910-2001H	256	91i-34116H	424	929R-1160	165		
905-2022H	258	910-2002H	256	91i-34117H	424	929R-4030	165		
905-2023H	258	910-2003H	256	91i-34118H	424	929R-4033	165		
905-2024H	258	910-2004H	256	91i-34119H	424	929R-4034	165		
905-2025H	258	910-2005H	256	91i-34120H	431	929R-4822	165		
905-2026H	258	910-2006H	256	91i-34125H	431	948-1010	216		
905-2027H	258	910-2007H	256	91i-34126H	431	948-1630	216		
905-2028H	258	910-2008H	256	91i-34127H	431	948-4822	217		
905-2029H	258	910-2009H	256	91i-34128H	431	948-9066	217		
905-2030H	258	910-2010H	256	91i-38110H	111, 339	948-9330	218		
905-2031H	258	910-2011H	256	91i-38115H	113, 341	948-9335	218		
905-2032H	258	910-2012H	256	91i-38116H	113, 341	948-9337	218		
905-2033H	258	910-2013H	256	91i-38117H	113, 341	948-9338	218		
905-2034H	258	910-2014H	256	91i-38118H	113, 341	948-9570	217		
905-2035H	258	910-2015H	256	920-2001H	256	948-9573	217		
905-2036H	258	910-2016H	256	920-2002H	256	948-9574	217		
905-2037H	258	910-2017H	258	920-2003H	256	950-1010	216		
905-2038H	258	910-2018H	258	920-2004H	256	950-1110	165		
905-2039H	258	910-2019H	258	920-2005H	256	950-1630	216		
905-2040H	258	910-2020H	258	920-2006H	256	950-4030	165		
905-2111H	256	910-2021H	258	920-2007H	256	950-4033	165		
905-2112H	256	910-2022H	258	920-2008H	256	950-4034	165		
905-2113H	256	910-2023H	258	920-2009H	256	950-4822	217		





Format	Serie	Seite(n)	Format	Serie	Seite(n)	Format	Serie	Seite(n)
1x1 cm	/ 3/8 x 3/8 Inch		10 x 10 cm	/ 4 x 4 Inch		15 x 30 cm	/ 6 x 12 Inch	
	Kauri	189-193		Area Pro	36-61		Basis 1	78-82
	Marble & More	208-211		Basis 2	78-84		Naturkeramik	212-219
	Plural	234-251		Basis 3	78-86		Plural	234-251
ø 1 cm	/ 3/8 Inch			Karl	182-187	15 x 60 cm	/ 6 x 48 Inch	
	Loop	198-207		Plural	234-251		Area Pro	36-61
2,5 x 2,5 cm	/ 1 x 1 Inch			Plural non-slip	252-259		Basis Pro	88-93
	Amano	32-35		Plural unglasiert	260-265		Emotion	146-155
	Fresh	166-181	10 x 15 cm	/ 4 x 24 Inch			Nova	226-233
	Karl	182-187		Basis 3	78-86		Unique	306-311
	Kauri	189-193		Emotion	146-155	15,4 x 15,4 cm	/ 6 3/16 x 6 3/16 Inch	
	Marble & More	208-211		Emotion Grip	156-161		Blindenleitsysteme	94-99
	Plural	234-251		Plural	234-251	20 x 7,9 cm	/ 8 x 3 1/8 Inch	
	Plural non-slip	252-259	10 x 20 cm	/ 4 x 6 Inch			Hohlkehlen Sockel Radialleisten	414-421
	Plural unglasiert	260-265		Area Pro	36-61	20 x 10 cm	/ 8 x 4 Inch	
ø 2 cm	/ 25/32 Inch			Basis 3	78-86		Hohlkehlen Sockel Radialleisten	414-421
	Loop	198-207		Emotion	146-155	20 x 20 cm	/ 8 x 8 Inch	
4 x 60 cm	/ 1 5/8 x 24 Inch			Emotion Grip	156-161		Area Pro	36-61
	Area Pro	36-61		Plural	234-251		Basis 1	78-82
4,5 x 20 cm	/ 1 13/16 x 8 Inch		10 x 25 cm	/ 4 x 10 Inch			Basis 2	78-84
	Basis 1	78-82		Ascona	62-73		Basis 3	78-86
5 x 5 cm	/ 2 x 2 Inch			District	138-141		Emotion	146-155
	Ascona	62-73		Karl	182-187		Emotion Grip	156-161
	Basic Stone	74-77	10 x 30 cm	/ 4 x 12 Inch			Plural	234-251
	Basis 3	78-86		Area Pro	36-61		Plural Kids	266-271
	Basis Pro	88-93		Basis Pro	88-93		Plural non-slip	252-259
	Fresh	166-181		Emotion	146-155		Plural unglasiert	260-265
	Nova	226-233		Plural	234-251	20 x 25 cm	/ 8 x 10 Inch	
	Plural	234-251		10 x 40 cm	/ 4 x 16 Inch		Basis 1	78-82
	Plural non-slip	252-259		Plural	234-251		20 x 40 cm	/ 8 x 16 Inch
	Plural unglasiert	260-265		10 x 50 cm	/ 4 x 20 Inch			Basis 1
	Quarzit	272-279		Ascona	62-73			Plural
	Savona	280-285		10 x 60 cm	/ 4 x 24 Inch			234-251
	Trias	300-305		Area Pro	36-61		20 x 60 cm	/ 8 x 24 Inch
	Unique	306-311		Ascona	62-73			Basis 1
	Valley	312-317		Basis Pro	88-93			78-82
5 x 10 cm	/ 2 x 4 Inch			Emotion	146-155			234-251
	District	138-141		Nova	226-233			
5 x 60 cm	/ 2 x 24 Inch			Plural	234-251			
	Unique	306-311		Quarzit	272-279			
	Valley	312-317		Unique	306-311			
	Xeno	318-321		Valley	312-317			
6 x 50 cm	/ 2 3/8 x 20 Inch			Xeno	318-321			
	Ascona	62-73	12,5 x 3,3 cm	/ 5 x 1 3/8 Inch				
	Quarzit	272-279		Spezialplatten	428-435			
	Savona	280-285	12,5 x 6,2 cm	/ 5 x 2 1/2 Inch				
	Streetlife	286-291		Spezialplatten	428-435			
6,2 x 25 cm	/ 2 1/2 x 10 Inch		12,5 x 12,5 cm	/ 5 x 5 Inch				
	Chroma	330-337		Ascona	62-73			
	Chroma unglasiert	346-351		Beckenkopfsystem Finnland II	364-369			
	Craft	126-133		Chroma	330-337			
6,2 x 50 cm	/ 2 1/2 x 20 Inch			Chroma non-slip	338-345			
	Craft extended	134-137		Chroma unglasiert	346-351			
7 x 20 cm	/ 2 13/16 x 8 Inch			Quarzit	272-279			
	Basis 3	78-86		Rillenplatten	422-427			
7 x 30 cm	/ 2 13/16 x 12 Inch			Spezialplatten	428-435			
	Basis 3	78-86		12,5 x 15,6 cm	/ 5 x 6 1/4 Inch			
7 x 60 cm	/ 2 13/16 x 24 Inch			Rillenplatten	422-427			
	Area Pro	36-61		Spezialplatten	428-435			
	Basis Pro	88-93		12,5 x 25 cm	/ 5 x 10 Inch			
	Emotion	146-155		Ascona	62-73			
	Nova	226-233		Chroma	330-337			
	Trias	300-305		Chroma non-slip	338-345			
	Unique	306-311		Chroma unglasiert	346-351			
	Valley	312-317		Craft	126-133			
	Xeno	318-321		Naturkeramik	212-219			
7 x 75 cm	/ 2 7/8 x 30 Inch			Quarzit	272-279			
	Valley	312-317		Spezialplatten	428-435			
7,2 x 60 cm	/ 2 7/8 x 24 Inch			12,5 x 30 cm	/ 5 x 12 Inch			
	Area Pro	36-61		Naturkeramik	212-219			
7,2 x 120 cm	/ 2 7/8 x 48 Inch			12,5 x 50 cm	/ 5 x 20 Inch			
	Area Pro	36-61		Chroma	330-337			
7,2 x 135 cm	/ 2 7/8 x 53 Inch			Plural	234-251			
	Area Pro	36-61		12,5 x 100 cm	/ 5 x 40 Inch			
7,9 x 25 cm	/ 3 1/8 x 10 Inch			Plural	234-251			
	Chroma unglasiert	346-351		15 x 15 cm	/ 6 x 6 Inch			
8,3 x 25 cm	/ 3 5/16 x 10 Inch			Area Pro	36-61			
	Craft	126-133		Ascona	62-73			
	Naturkeramik	212-219		Basis 1	78-82			
8,3 x 30 cm	/ 3 7/16 x 12 Inch			Basis 2	78-84			
	Naturkeramik	212-219		Basis 3	78-86			
				Basis Pro	88-93			
				Emotion	146-155			
				Naturkeramik	212-219			
				Nova	226-233			
				Plural	234-251			
				Plural unglasiert	260-265			
				Quarzit	272-279			
				Savona	280-285			
				Valley	312-317			

Format	Serie	Seite(n)
	Basis 1+	78-83
25 x 50 cm	/ 10 x 20 Inch	
	Ascona	62-73
	Chroma	330-337
	Chroma unglasiert	346-351
	Plural	234-251
	Quarzit	272-279
	Spezialplatten	428-435
	Valley	312-317
27,8 x 20 cm	/ 11 x 8 Inch	
	Emotion Grip	156-161
28 x 135 cm	/ 11 x 55 5/32 Inch	
	Area Pro	36-61
	Ascona	62-73
	Nova	226-233
	Quarzit	272-279
30 x 7,9 cm	/ 12 x 3 1/8 Inch	
	Hohlkehlen Sockel Radialleisten	414-421
30 x 8,7 cm	/ 12 x 3 1/2 Inch	
	Eladuct + KerAion Ela 10.6	142-145
30 x 30 cm	/ 12 x 12 Inch	
	Area Pro	36-61
	Basis 3	78-86
	Basis Pro	88-93
	Blindenleitsysteme	94-99
	Emotion	146-155
	Emotion Grip	156-161
	New Market	220-225
	Plural	234-251
	Quarzit	272-279
	Unique	306-311
	Valley	312-317
30 x 45 cm	/ 12 x 18 Inch	
	Basis 1	78-82
	Basis 1+	78-83
30 x 60 cm	/ 12 x 24 Inch	
	Area Pro	36-61
	Ascona	62-73
	Basis 1	78-82
	Basis 1+	78-83
	Basis 3	78-86
	Basis Pro	88-93
	Emotion	146-155
	New Market	220-225
	Nova	226-233
	Plural	234-251
	Quarzit	272-279
	Savona	280-285
	Trias	300-305
	Unique	306-311
	Valley	312-317
	Xeno	318-321
30 x 90 cm	/ 12 x 36 Inch	
	Area Pro	36-61
	Basis 1	78-82
	Basis 1+	78-83
31 x 30 cm	/ 12 13/64 x 12 Inch	
	Craft extended	134-137
30 x 120 cm	/ 12 x 48 Inch	
	Streetlife	286-291
31 x 135 cm	/ 12 13/64 x 53 Inch	
	Area Pro	36-61
	Ascona	62-73
	Nova	226-233
	Quarzit	272-279
35 x 35 cm	/ 14 x 14 Inch	
	Naturkeramik	212-219
35 x 100 cm	/ 14 x 40 Inch	
	Basis 1	78-82
	Basis 1+	78-83
40 x 60 cm	/ 16 x 24 Inch	
	Area Pro	36-61
45 x 80 cm	/ 16 x 53 Inch	
	Area Pro	36-61
50 x 25 cm	/ 20 x 10 Inch	
	Ascona	62-73
	Beckenkopfsystem Finnland II.	364-369
	Quarzit	272-279
50 x 100 cm	/ 20 x 40 Inch	
	Ascona	62-73
	Plural	234-251
55 x 120 cm	/ 22 x 48 Inch	

Format	Serie	Seite(n)
	Area Pro	36-61
60 x 60 cm	/ 24 x 24 Inch	
	Area Pro	36-61
	Ascona	62-73
	Basis Pro	88-93
	Eladuct + KerAion Ela 10.6	142-145
	Emotion	146-155
	KerAion OP-Spezialglasuren	194-197
	Nova	226-233
	Quarzit	272-279
	Savona	280-285
	Streetlife	286-291
	Trias	300-305
	Unique	306-311
	Valley	312-317
60 x 90 cm	/ 24 x 36 Inch	
	Area Pro	36-61
	Ascona	62-73
	Streetlife	286-291
60 x 120 cm	/ 24 x 48 Inch	
	Area Pro	36-61
	Nova	226-233
	Savona	280-285
	Streetlife	286-291
	Unique	306-311
	Valley	312-317
75 x 75 cm	/ 30 x 30 Inch	
	Valley	312-317
90 x 90 cm	/ 36 x 36 Inch	
	Area Pro	36-61
120 x 120 cm	/ 48 x 48 Inch	
	Nova	226-233

Format-Nr.	Seiten	Format-Nr.	Seiten	Format-Nr.	Seiten	Format-Nr.	Seiten	Format-Nr.	Seiten
1010	216	34126H	431	4033	165	55722	362	85183	375
1020	216	34127H	431	4034	165	55725	362	85185	375
1030	216	34128H	431	41550HK	104, 106, 107,	55729	362	85186	375
1100	145, 165, 216	34136H	430		334, 335, 336	55730	361	85187	375
1160	165	34137H	430	42550HK	104, 106, 107, 122,	55732	361	85188	375
12020H	104, 106, 107,	34138H	430		334, 335, 336, 348	55735	361	85190	375
	334, 335, 336	34139H	430	42580HK	123, 349	55736	361	85191	375
12023H	105, 337	34146H	425	44025		55737	361	85193	375
12050H	104, 106, 107,	34147H	425	44026		55738	361	85195	375
	334, 335, 336	34148H	425	4822	132, 165, 217	55740	363	85196	375
12053H	105, 337	34149H	425	4825		55742	363	85197	375
1620	216	341550HK	245, 247	53130		55745	363	85198	375
1630	216	34156H	425	53135		55749	363	86160	393
17112	417	34157H	425	53136		55750	363	86161	393
17190	417	34158H	425	53137		55752	363	86162	393
17191	417	34159H	425	53138		55755	363	86163	393
17193	417	34166H	430	53139		55759	363	86165	393
17194	417	34167H	430	53150	279, 368	55760	362	86167	393
17196	417	34168H	430	53151	279, 368	55762	362	86168	393
18120	87	34169H	430	53159	279, 368	55765	362	87160	381
18120H	104, 106, 107,	34170H	431	53190		55766	362	87161	381
	334, 335, 336	342030H	277, 284	53195		55770	362	87163	381
18123H	105, 337	342550HK	277, 246, 248	53196		55775	362	87165	381
18124H	105, 337	342555HK	278	53197		55800	413	87166	381
18190	417	342557HK	278	53198		55802	413	87167	381
18191	417	342580HK	277	53199		55805	413	87168	381
18192	417	34306	431	53320	279, 434	55806	413	9063	217
18193	417	34306H	124, 351	53321	279, 434	55820	367	9066	217
18194	417	34307	431	53322	279, 434	55821	367	9215	137
18196	417	34308	431	53323	279, 434	55822	367	9220	132
18210H	104, 106, 107,	34309	431	53510		55825	367	9330	218
	334, 335, 336	352010HK	245, 246, 247, 248	53510H		55826	367	9335	218
18213H	105, 337	37011	433	53511		55830	367	9337	218
18214H	105, 337	37015	433	53511H		55831	367	9338	218
2110	131	37017	433	53512		55832	367	95160	377
2120	131	37018	433	53512H		55835	367	95161	377
2240	131	37021	418	54420		55836	367	95163	377
2250	131	37023	418	54421		55840	368	95165	377
2270	131	37024	418	54422		55841	368	95166	377
2280	131	37031	433	54423		55845	368	9570	217
2290	137	37035	433	55100		55850	393	9573	217
2320	137	37040	145	55101		55852	393	9574	217
2521	132	37042	145	55105		55855	393	9822	218
2541	218	37043	145	55106		55856	393	B200HK	277, 284
27180H	125, 350	37044	145	55107		55857	393	B600HK	197, 277, 284
27181H	125, 350	37080	124, 351, 418	55108		55858	393	B611HK	278, 284
27182H	125, 350	37081	124, 351, 418	55140		59420	361	B612HK	278
2720	132	37082	124, 351, 418	55141		59422	361	B670HK	284
2721	132	37088	417	55143		59425	361	B700HK	290
32020H	111, 112, 115, 122,	37090	418	55145		59426	361	B710HK	290
	277, 339, 340, 343, 348	37091	418	55146		59427	361	B729HK	290
32025H	113, 116, 341, 344	37092	418	55147		59428	361	B755HK	290
32027H	113, 116, 341, 344	37120	419	55148		59620	427	B770HK	290
32050H	111, 112, 115, 122,	37121	419	55180		59627	427	B775HK	278
	339, 340, 343, 348	37122	419	55181		59628	427	B776HK	278
32055H	113, 116, 341, 344	37125	420	55185		59629	427	K100	145
32057H	113, 116, 341, 344	37126	420	55186		59630	427	S10002	432
32059	432	37127	420	55187		59637	427	S50044	373
32080H	123, 349	37150	432	55188		59638	427	S50065	385
32100H	123, 349	37155	432	55440		59639	427	S55102	385
332050HK	277	37180	419	55442		59680	433	S55142	385
34020	418	37182	419	55445		59681	433	S55182	373
34020H	124, 351	37183	420	55446		59685	433	S85162	373
34070H	431	37185	420	55450		61061HK	279	S85182	375
34090H	123, 277, 349	37186	417	55452		6635	99	S85192	375
34100	424	37188	419	55455		6636	99	S87162	381
34105	424	37189	420	55456		703	247, 245	S95162	377
34106	424	38110	87	55460		7161H	277, 284		
34107	424	38110H	111, 112, 115, 122,	55462		730	246, 248		
34108	424		277, 339, 340, 343, 348	55465		8110	87		
34109	424	38115H	113, 116, 341, 344	55466		85160	373		
34110	424	38116H	113, 116, 341, 344	55520		85161	373		
34115	424	38117H	113, 116, 341, 344	55522		85163	373		
34116	424	38118H	113, 116, 341, 344	55526		85165	373		
34117	424	38119	432	55563		85166	373		
34118	424	4000	145	55565		85167	373, 377		
34119	424	4003	145	55566		85168	373, 377		
34120H	431	4004	145	55567		85180	375		
34125H	431	4030	165	55720		85181	375		

Agrob Buchtal offeriert bei vielen Serien überglasierte Kanten. Bei **Spalt- und Steinzeugplatten** sind auf Anfrage überglasierte bzw. überglasierte *gerundete* Kanten gemäß folgender Format-Nummern-Systematik erhältlich:

					
Grundformat-Nr. statt	...1 = Kopfkante	...2 = Längskante	...3 = Ecke links	...4 = Ecke rechts	überglasierte Kanten
Endziffer 0 Endziffer...	...5 = Kopfkante	...6 = Längskante	...7 = Ecke links	...8 = Ecke rechts	überglasierte gerundete Kanten

Beispiel: Grundformat-Nr. 18120 = 244 x 119 x 6 mm,
 Format-Nr. 18123 = überglasierte Ecke links

Area Pro

Farbe	NCS Hauptfarbe	RAL Hauptfarbe	Color Shade Variation
anthrazit	S7502-B	7024	V2
basalt	S7005-B80G	180 4005	V2
kiesel	S3502-Y	7030	V2
stein	S2502-Y	100 7005	V2
sandweiß	S1502-Y50R	080 8005	V2
sandgrau	S1502-Y50R	080 7005	V2
sand	S5005-Y20R	075 5010	V2
muskat	S7005-Y50R	060 4005	V2
platin	S0500-N	8500	V2
sandbeige	S1005-Y50R	060 8010	V2
ziegel	S7010-Y30R	060 4010	V2
lehm	S8010-Y50R	050 3010	V2

ChromaPlural
Chroma non-slip
Chroma unglasiert

Farbe	ähnlich NCS-Nr.	ähnlich RAL-Nr.	Hellbezugs- wert Y
neutral 1 (Chroma unglasiert)	S9000-N	9017	3
neutral 1	8000	7016	6
neutral 2	S7500-N	7015	9
neutral 3	S6500-N		15
neutral 4	S6000-N	7037	18
neutral 5	S5502-B	7046	21
neutral 6	S4502-B	7045	25
neutral 7	S4000-N	7004	33
neutral 8	S2502-B		46
neutral 9	S1502-R50B		65
neutral 10 (ChromaPlural)	S1000-N	9003	76
neutral 10 (Chroma unglasiert)	0502-Y	9001	66
neutral 10 (weiß glänzend)	S1500	9003	70
azur aktiv	S5030-R80B	5000	9
azur hell	S2030-R80B		37
azur mittel	S4030-R90B		21
azur dunkel	S4040-R90B	5007	13
blau aktiv	S6030-R90B		7
blau hell	S1510-R80B		60
blau mittel	S2020-R80B		40
blau dunkel	S4030-R80B		17
türkis aktiv	S4030-B50G	6033	22
türkis hell	S1010-B50G		63
türkis mittel	S2020-B30G		44
türkis dunkel	S4020-B30G		26
grün aktiv	S3050-G50Y		26
grün hell	S0510-G		69
grün mittel	S1515-G20Y	6019	53
grün dunkel	S3020-G10Y	6021	31
gelb aktiv	S3050-Y10R		32
gelb hell	S1010-Y10R	1015	69
gelb mittel	S2030-Y10R		50
gelb dunkel	S2050-Y20R		33
ocker aktiv	S3050-Y40R		20
ocker hell	S2030-Y20R		48
ocker mittel	S3030-Y30R		36
ocker dunkel	S4030-Y50R		21
lachs aktiv	S4040-Y70R		15
lachs hell	S1515-Y50R		51
lachs mittel	S2020-Y50R		39
lachs dunkel	S3040-Y60R		23
oxidrot aktiv	S4050-Y90R		10
oxidrot hell	S2010-Y80R		46
oxidrot mittel	S3020-Y80R		25
oxidrot dunkel	S5020-Y80R		15
steingrau aktiv	S5030-Y90R		9
steingrau hell	S2502-R		46
steingrau mittel	S3502-R	7036	34
steingrau dunkel	S6005-Y80R		15
sandgrau aktiv	S7010-Y90R		8
sandgrau hell	S1502-Y		56
sandgrau mittel	S3005-Y50R		35
sandgrau dunkel	S6010-Y50R		14

Sonderfarben

Farbe	ähnlich NCS-Nr.	ähnlich RAL-Nr.	Hellbezugs- wert Y
apfelgrün	S1060-G40Y		39
braun mittel	S5020-Y50R	060 50 20	17
grau mittel	S3502-Y	100 70 05	32
intensivblau	6040-R70B		1
kontrastrot (Chroma non-slip B)	S2050-Y90R	3017	14
kontrastrot (Chroma non-slip C)	S2060-Y90R	3018	15
kontrastrot (Chroma)	S2570-Y90R	3002	10
naturweiß	2005-Y20R	7032	51
orange	S2060-Y50R	2010	24
sandbeige mittel	S1010-Y20R	1001	44
tiefanthrazit	S6010-R90B	260 40 05	8
tiefblau	S4050-R70B	290 30 35	8
tiefgelb	S0560-Y	085 80 70	52
tiefgrün	S6020-G30Y	140 40 20	11
tieforange	S2060-Y60R	040 50 50	24
tiefrot	S1080R	030 40 50	11
violett	S5020-R50B	4001	13
zitronengelb	1070-Y	1016	52

KerAion OP-Spezialglasuren

Farbe	ähnlich NCS-Nr.	ähnlich RAL-Nr.	Hellbezugs- wert Y
beige	0502-Y	1013	69
blau	0530-R90B		46
grau	3000-N	7038	47
grün	2030-B70G	6027	36
hellgrau	1502-G50Y	7047	58
weiß	0500-N	9003	78

Der durchgängige Einsatz des architektonischen Gestaltungsmittels Farbe hat in den letzten Jahren weiter an Bedeutung gewonnen. Deshalb finden Sie als Planungshilfe eine Aufstellung der relevanten Agrob Buchtal-Gestaltungsserien nach:

NCS = Natural Color System

(Nähere Informationen bei: Scandinavian Color Institute AB, · P.O.Box 49022
S-10028 Stockholm · Tel. +46/8/6174700 · Fax +46/8/6174747,
Institut für Farbe – Brigitte Hartmann · Rotes Knie 6 · 74389 Cleebrohn
Tel. 071 35/1 2742 · Fax 071 35/1 2737)

RAL-Farbskala

(Nähere Informationen bei: RAL – Deutsches Institut für Gütesicherung und
Kennzeichnung e.V. · Siegburger Straße 39 · D-53757 St. Augustin
Tel. 02241/1605-0 · Fax 02241/1605-11)

Hellbezugswert:

Diese Angabe (Normfarbwert Y) beschreibt die Helligkeit einer Farbe im Vergleich zu einer ideal weißen, nach Stärke, Richtung und Qualität ebenso beleuchteten Fläche. Für ein ideales Weiß gilt: Y = 100, schwarz: Y = 0, d.h. alles auffallende Licht wird zurückgeworfen.

Bitte beachten Sie, dass diese Zuordnungen nur als Orientierungshilfe dienen können und ggf. Originalmuster, die wir Ihnen gerne zur Verfügung stellen, empfehlenswert sind.

Als Leuchtdichtekontrast wird der Helligkeitsunterschied zweier benachbarter farbiger Flächen bezeichnet. Anhand dieses Wertes kann festgestellt werden, ob es sich um eine kontrastreiche Raumgestaltung handelt, wie sie z.B. von der DIN 32975 „Gestaltung visueller Informationen im öffentlichen Raum zur barrierefreien Nutzung“ gefordert wird.

Nachfolgend finden Sie die entsprechenden Werte für ausgewählte Serien. Diese ergeben sich aus den jeweiligen Hellbezugswerten, die als gemittelte Werte einzelner Messungen angegeben werden. Werte für andere Produkte ermitteln wir gerne auf Anfrage.

Leuchtdichtekontrast Serie Area Pro										
		anthrazit	basalt	kiesel	stein	sandweiß	sandgrau	sand	muskat	
<i>Hellbezugswert Y</i>		8	13	21	33	50	38	21	14	
anthrazit	8	0,00	0,23	0,44	0,60	0,72	0,64	0,44	0,24	
basalt	13		0,00	0,23	0,43	0,59	0,49	0,24	0,01	
kiesel	21			0,00	0,22	0,41	0,29	0,01	0,22	
stein	33				0,00	0,21	0,08	0,21	0,42	
sandweiß	50					0,00	0,14	0,40	0,58	
sandgrau	38						0,00	0,28	0,48	
sand	21							0,00	0,23	
muskat	14								0,00	
platin	58									
sandbeige	41									
ziegel	14									
lehm	10									

Leuchtdichtekontrast Serie Emotion (Boden)							
		tiefanthrazit	bronze	basalt	mittelgrau	graubraun	hellbeige
<i>Hellbezugswert Y</i>		7	9	19	32	15	46
tiefanthrazit	7	0,00					
bronze	9	0,13	0,00				
basalt	19	0,46	0,36	0,00		0,12	
mittelgrau	32	0,64	0,56	0,25	0,00	0,36	
graubraun	15	0,36	0,25			0,00	
hellbeige	46	0,74	0,67	0,42	0,18	0,51	0,00

Leuchtdichtekontrast Serie Nova							
		cremebeige	mittelbraun	mittelgrau	basalt	anthrazit	anthrazit bunt
<i>Hellbezugswert Y</i>		44	18	35	15	6	9
cremebeige	44	0,00	0,42	0,11	0,49	0,76	0,66
mittelbraun	18		0,00		0,09	0,50	0,33
mittelgrau	35		0,32	0,00		0,71	
basalt	15				0,00	0,43	0,25
anthrazit	6					0,00	
anthrazit bunt	9					0,20	0,00

Leuchtdichtekontrast Serie Quarzit						
		basaltgrau	quarzgrau	sandbeige	sepiabraun	weißgrau
<i>Hellbezugswert Y</i>		15	40	47	30	55
basaltgrau	15	0,00				
quarzgrau	40	0,45	0,00		0,14	
sandbeige	47	0,52	0,08	0,00	0,22	
sepiabraun	30	0,33			0,00	
weißgrau	55	0,57	0,16	0,08	0,29	0,00

Leuchtdichtekontrast Serie Area Pro (Fortsetzung)

		platin	sandbeige	ziegel	lehm
<i>Hellbezugswert Y</i>		58	41	14	10
anthrazit	8	0,75	0,66	0,25	0,07
basalt	13	0,63	0,51	0,03	0,16
kiesel	21	0,47	0,32	0,21	0,38
stein	33	0,28	0,11	0,41	0,55
sandweiß	50	0,07	0,11	0,57	0,68
sandgrau	38	0,21	0,04	0,47	0,60
sand	21	0,46	0,31	0,21	0,38
muskat	14	0,62	0,50	0,01	0,17
platin	58	0,00	0,18	0,62	0,72
sandbeige	41		0,00	0,49	0,62
ziegel	14			0,00	0,19
lehm	10				0,00

Leuchtdichtekontrast Serie Savona

		kalk	beige	braun	grau	anthrazit
<i>Hellbezugswert Y</i>		52	38	20	20	8
kalk	52	0,00	0,16	0,44	0,44	0,73
beige	38		0,00	0,31	0,31	0,65
braun	20			0,00	0,00	0,43
grau	20			0,00	0,00	0,43
anthrazit	8					0,00

Leuchtdichtekontrast Serie Unique

		anthrazit	basalt	hellgrau	kalk	beige	braun	schlamm	dunkelbraun
<i>Hellbezugswert Y</i>		6	17	36	55	45	18	30	10
anthrazit	6	0,00							
basalt	17	0,48	0,00						0,26
hellgrau	36	0,71	0,36	0,00			0,33	0,09	0,57
kalk	55	0,80	0,53	0,21	0,00	0,10	0,51	0,29	0,69
beige	45	0,76	0,45	0,11		0,00	0,43	0,20	0,64
braun	18	0,50	0,03				0,00		0,29
schlamm	30	0,67	0,28				0,25	0,00	0,50
dunkelbraun	10	0,25							0,00

Leuchtdichtekontrast Serie Valley

		schiefer	kieselgrau	erdbraun	sandbeige
<i>Hellbezugswert Y</i>		9	33	10	51
schiefer	9	0,00			
kieselgrau	33	0,57	0,00	0,53	
erdbraun	10	0,05		0,00	
sandbeige	51	0,70	0,21	0,67	0,00

Güteforderungen europäischer Normen

Produktnormen (vereinfacht und auf Format 20x20 cm (BIII), bzw. 30x30cm (BI) bezogen!)	Stranggepresste keram. Fliesen und Platten DIN EN 14411		Trockengepresste keram. Fliesen u. Platten DIN EN 14411		Prüfnormen
	Gruppe AI _a + AI _b „Natur“ „Präzision“	Gruppe AII _a -Teil 1 „Natur“ „Präzision“	Gruppe BI _a + BI _b	Gruppe BIII	
A) Abmessungen + Oberflächen					
1. Länge und Breite	± 2% ± 1,0%	± 2% ± 1,25%	± 0,6%	± 0,5%	DIN EN ISO 10545-2
2. Dicke	± 10% ± 10%	± 10% ± 10%	± 5%	± 10%	DIN EN ISO 10545-2
3. Geradheit der Kanten	± 0,6% ± 0,5%	± 0,6% ± 0,5%	± 0,5%	± 0,3%	DIN EN ISO 10545-2
4. Rechtwinkeligkeit	± 1,0% ± 1,0%	± 1,0% ± 1,0%	± 0,5%	± 0,5%	DIN EN ISO 10545-2
5. Ebenflächigkeit					DIN EN ISO 10545-2
5.1 Mittelpunktwölbung	± 1,5% ± 0,5%	± 1,5% ± 0,5%	± 0,5%	+ 0,5/-0,3%	DIN EN ISO 10545-2
5.2 Kantenwölbung	± 1,5% ± 0,5%	± 1,5% ± 0,5%	± 0,5%	+ 0,5/-0,3%	DIN EN ISO 10545-2
5.3 Windschiefe	± 1,5% ± 0,8%	± 1,5% ± 0,8%	± 0,5%	± 0,5%	DIN EN ISO 10545-2
6. Oberflächen mängelfrei	mind. 95%	mind. 95%	mind. 95%	mind. 95%	DIN EN ISO 10545-2
7. Farbabweichungen	•	•	•	•	DIN EN ISO 10545-16
7.1 Brandfarbensortierung	•	•	•	•	Deutsche Steinzeug
8. Größensortierung ¹⁾	•	•	•	•	Deutsche Steinzeug
B) Physikalische Eigenschaften				glasiert	
1. Wasseraufnahme im Mittel/ max. Einzelwert	AI _a E ≤ 0,5%/0,6% AI _b 0,5% < E ≤ 3%/3,3%	≤ 6/6,5%	BI _a ≤ 0,5% BI _b ≤ 3%	> 10%	DIN EN ISO 10545-3
2. Biegefestigkeit Klammerwert= min. Einzelwert	AI _a min. 28 (21)N/mm ² AI _b min. 23 (18)N/mm ²	min. 20 (18)N/mm ²	BI _a min. 35 (32) N/mm ² BI _b min. 30 (27) N/mm ²	Dicke < 7,5 mm: 15N/mm ² Dicke ≥ 7,5 mm: 12N/mm ²	DIN EN ISO 10545-4
2.1 Bruchlast ≥ 7,5 mm Dicke	AI _a min. 1300 N AI _b min. 1100 N	mind. 950 N	BI _a min. 1300 N BI _b min. 1100 N	mind. 600 N	DIN EN ISO 10545-4
2.2 Bruchlast < 7,5 mm Dicke	mind. 600 N	mind. 600 N	mind. 700 N	mind. 200 N	DIN EN ISO 10545-4
3. Schlagfestigkeit	•	•	•	•	DIN EN ISO 10545-5
4. Widerstand Tiefenverschleiß	≤ 275 mm ³	≤ 393 mm ³	≤ 175 mm ³	–	DIN EN ISO 10545-6
5. Widerstand Glasurabrieb	0-5	0-5	0-5	0-5	DIN EN ISO 10545-7
6. Ausdehnungskoeffizient max.	•	•	•	•	DIN EN ISO 10545-8
7. Temperaturwechselbeständigkeit	•	•	•	•	DIN EN ISO 10545-9
8. Feuchtedehnung	< 0,001 mm/m	< 0,001 mm/m	ca. 0,001 mm/m	ca. 0,01 mm/m	DIN EN ISO 10545-10
9. Widerstand gegen Glasurrisse	gefordert	gefordert	gefordert	gefordert	DIN EN ISO 10545-11
10. Wärmeleitfähigkeit	ca. 1 W/mK	ca. 1 W/mK	ca. 1 W/mK	ca. 0,8 W/mK	Deutsche Steinzeug
11. Ableitwiderstand	> 10 ¹⁰ Ohm ³⁾	> 10 ¹⁰ Ohm ³⁾	10 ¹⁰ Ohm	10 ¹⁰ Ohm	DIN EN 1081
12. Dampfdiffusionswiderstand	ca. μ 120.000	ca. μ 120.000	ca. μ 120.000	ca. μ 100.000	DIN EN ISO 12572
13. Frostbeständigkeit	gefordert	nicht gefordert, jedoch von AGROB BUCHTAL erfüllt	gefordert	–	DIN EN ISO 10545-12
14. Licht- und Farbechtheit	•	•	•	•	DIN 51094
15. Hellbezugswert	nach Angabe	nach Angabe	nach Angabe	nach Angabe	Deutsche Steinzeug
16. Brandverhalten	A1/A1 _{fl}	A1/A1 _{fl}	A1/A1 _{fl}	A1/A1 _{fl}	DIN 4102/DIN EN 13501-1
C) Chemische Eigenschaften²⁾					
1. Chemikalienbeständigkeit	siehe Prüfzeugnis	siehe Prüfzeugnis	siehe Prüfzeugnis	siehe Prüfzeugnis	DIN EN ISO 10545-13
2. Beständigkeit gegen Haushalts- chemikalien & Badewasserzusätze	min. GB bzw. UB	min. GB bzw. UB	min. GB bzw. UB	–	
3. Fleckbeständigkeit (glasiert)	min. Kl. 3	min. Kl. 3	min. Kl. 3	min. Kl. 3	DIN EN ISO 10545-14
4. Blei- und Cadmiumabgabe	•	•	•	•	DIN EN ISO 10545-15
5. Hytect	siehe Prüfzeugnis	siehe Prüfzeugnis	siehe Prüfzeugnis	siehe Prüfzeugnis	Deutsche Steinzeug
D) Trittsicherheit					
1. Reibungskoeffizient	•	•	•	–	E-DIN EN ISO 10545-17
1.1 Gewerbebereich (BG) Berufsgenossenschaften	Gruppen R9-13/V4-10	Gruppen R9-13/V4-10	Gruppen R9-13/V4-10	–	DIN 51130 DGUV-R 108-003 (BGR 181)
1.2 Barfußbereich (BUK) BV-Unfallkassen	Gruppen A/B/C	Gruppen A/B/C	Gruppen A/B/C	–	DIN 51097 DGUV-I 207-006 (GUV-I 8527)

1) Pakete nach Größenklassen und Brandfarben gekennzeichnet.

2) Flusssäure und deren Verbindungen ausgeschlossen.

3) Ausnahmen:

KerAion ELA 10.6: Ableitwiderstand 10⁶ Ohm DIN EN 1081

Deutsche Steinzeug-Fliesen und -Platten erbringen günstigere Werte als die Normen fordern.

Außerdem sind sie baubiologisch, ökologisch, hygienisch und bakteriologisch unbedenklich; dies ist durch Rohmaterialauswahl, Aufbereitungsart und Brenntechnik gewährleistet.

Alle Angaben sowie Zitate aus Produkt- und Prüfnormen sind als unverbindliche Hinweise zu betrachten. Es gelten die jeweils aktuellsten Fassungen.

Begriffe und Klassifizierung gemäß DIN EN 14411

Alle unsere Fliesen und Platten bestehen aus natürlichen Rohstoffen wie Ton, Quarzsand und Feldspäten, die aufbereitet, veredelt und gebrannt werden. Je nach Anwendungszweck werden sie glasiert (GL) oder unglasiert (UGL) hergestellt. Sie lassen sich gemäß DIN EN 14411 wie folgt einordnen:

Klassifizierung der keramischen Fliesen und Platten nach ihren Gruppen der Wasseraufnahme (E) und ihrer Formgebung

Formgebung	Gruppe I E ≤ 3%	Gruppe II _a 3% < E ≤ 6%	Gruppe II _b 6% < E ≤ 10%	Gruppe III E > 10%
A stranggepresste Fliesen und Platten	Gruppe AI _a E ≤ 0,5% (Anhang M)	Gruppe AII _{a-1} ^{a)} (Anhang B)	Gruppe AII _{b-1} ^{a)} (Anhang D)	Gruppe AIII (Anhang F)
	Gruppe AI _b 0,5% < E ≤ 3% (Anhang A)	Gruppe AII _{a-2} ^{a)} (Anhang C)	Gruppe AII _{b-2} ^{a)} (Anhang E)	
B trockengepresste Fliesen und Platten	Gruppe BI _a E ≤ 0,5% (Anhang G)	Gruppe BII _a (Anhang J)	Gruppe BII _b (Anhang K)	Gruppe BIII _{b)} (Anhang L)
	Gruppe BI _b 0,5% < E ≤ 3% (Anhang H)			
a) Gruppen AII _a und AII _b werden in zwei Teile (Teile 1 und 2) mit verschiedenen Produktanforderungen unterteilt. b) Gruppe BIII trifft im Wesentlichen für glasierte Fliesen und Platten zu. Es gibt eine geringe Anzahl trockenepresster unglasierter Fliesen und Platten, die mit einer Wasseraufnahme über 10% hergestellt werden, für die diese Produktgruppe nicht zutrifft.				

Im traditionellen Sprachgebrauch stehen:

stranggepresste Fliesen und Platten (mit A gekennzeichnet)

Fliesen und Platten, die in bestimmter Länge von einem Strang abgeschnitten werden, der aus der plastischen Masse mit einer Strangpresse geformt wurde.

trockengepresste Fliesen und Platten

(mit B gekennzeichnet)

Fliesen und Platten, die aus einer fein gemahlten und anschließend granulierten Masse unter hohem Druck in Form gepresst werden.

Spaltplatten sind frostbeständige stranggezogene Doppelplatten, die stehend bei einer Temperatur bis max. 1280 °C gebrannt werden.

Steinzeugplatten sind frostbeständige flachextrudierte Einzelplatten mit einer Brenntemperatur von ca. 1260 °C.

KerAion ist die einzigartige keramische, flachextrudierte Großflächenplatte von Agrob Buchtal.

Steinzeugfliesen sind frostbeständige, trockenepresste Einzelfliesen mit einer Brenntemperatur bis zu 1200 °C.

Feinsteinzeug steht für besonders dicht gesinterte Fliesen und Platten mit einer Wasseraufnahme < 0,5%.

Mosaik sind kleinformatige, auf Bögen verklebte (Fein-)Steinzeugfliesen.

Steingutfliesen sind nicht frostbeständige, trockenepresste Einzelfliesen mit einer Brenntemperatur bis zu ca. 1100 °C.

Die Wasseraufnahme E in Gewichts-% wird nach DIN EN ISO 10 545-3 ermittelt.

Beschreibung von Maßen

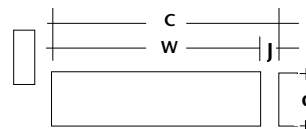

Koordinierungsmaß (C) in cm = Werkmaß (W) + Fuge (J)
 Werkmaß (W) in mm = Maße der Ansichtsflächen und Dicke (d)

Abmessungen und Oberflächen

1 - 5. Abmessungen, DIN EN ISO 10545-2

Alle Maße werden nach der Norm ermittelt.

Zulässige Längen- und Breiten-Toleranzen entsprechend der Produktnormen						
DIN EN 14411	Gruppe AI _a / AI _b (25x12,5 cm)		Gruppe AII _a (25x12,5 cm)		Gruppe BI _a / BI _b (30x30 cm)	Gruppe BIII (10x10 cm)
	„Natur“	„Präzision“	„Natur“	„Präzision“		
Abweichung vom Herstellmaß	± 2%	± 1,0%	± 2%	± 1,25%	± 0,6%	± 0,5%
Abweichung von durchschnittl. Seitenlänge	± 1,5%	± 1,0%	± 1,5%	± 1,0%	± 0,5%	± 0,5%

Die Herstellmaße der **Formteile** sind bei uns nach Sichtseiten angegeben.

6. Oberflächenbeschaffenheit, DIN EN ISO 10545-2

Die Oberflächen von 1 m² bzw. 30 Stück werden bei 300 Lux aus 1 m Entfernung auf sichtbare Mängel kontrolliert.

7. Farbabweichungen, DIN EN ISO 10545-16

Für glasierte Uni-Waren gilt Δ E_{cmc} < 0,75 als farbgleich, für unglasierter Uni-Waren 1,0.

7.1. Brandfarbensortierung

Die Brandfarbengehörigkeit wird codiert auf die Verpackung gestempelt. Nur gleiche Brandfarben ergeben eine einheitliche Optik. Bei rustikalen Spaltplatten sind größere Farbabweichungen üblich. Es sollte aus diversen Paketen gemischt verlegt werden.

8. Größensortierung

Produktionstechnisch bedingt variieren die Herstellmaße. Das Herstellmaß wird codiert auf die Verpackung gestempelt. Es sollten nur Pakete gleicher Codierung miteinander verlegt werden. Die Differenzen werden gemäß VOB in den Fugen ausgeglichen.

Alle Angaben sowie Zitate aus Produkt- und Prüfnormen sind als unverbindliche Hinweise zu betrachten. Es gelten die jeweils aktuellsten Fassungen.

Physikalische Eigenschaften

1. Wasseraufnahme, DIN EN ISO 10545-3

Die **Wasseraufnahme (E)** gibt die Gewichtszunahme von unter Vakuum mit Wasser gesättigten Proben zum Trockengewicht an.

1.1 Rohdichte, DIN EN ISO 10545-3

Sie gibt das Verhältnis zwischen Masse und äußerem Volumen an.

2. Biegefestigkeit, DIN EN ISO 10545-4

Die Bruchkraft **F** wird an Proben über die Dreipunktbelastung in **N** ermittelt. Hieraus werden nach folgenden Formeln die Biegefestigkeit und Bruchlast errechnet.

Biegefestigkeit

$$R = \frac{3 \cdot F \cdot L}{2 \cdot b \cdot h^2}$$

F = Bruchkraft in N
L = Stützweite in mm
b = Breite in mm
h = Dicke in mm
R = Biegefestigkeit

Bruchlast

$$S = \frac{F \cdot L}{b}$$

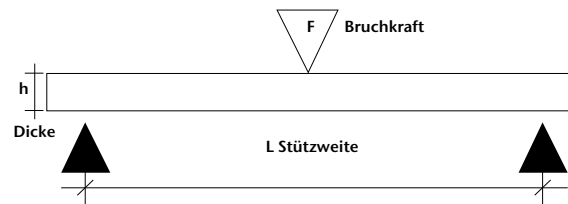

Einsatzmöglichkeiten	Belastungsgruppe
Bruchkraft unter 1.500 N Wohnungsbau und Bodenbeläge mit vergleichbarer mechanischer Beanspruchung, z. B. Hotelbadezimmer, Räume des Gesundheitsdienstes	1
Bruchkraft 1.500 – 3.000 N Verwaltung, Gewerbe und Industrie (befahrbar mit luftbereiften Fahrzeugen), z. B. Großküchen, Kantinen, Verkehrszonen, KFZ-Ausstellungs- und Wartungsräume, Verkaufsräume, jeweils ohne Flurförderfahrzeugverkehr Pressungen bis 2 N/mm ²	2
Bruchkraft 3.000 – 5.000 N Gewerbe und Industrie (Flurförderfahrzeugverkehr mit Superelastik-, Vollgummi- und Vulkollanbereifung), z. B. im Lebensmittel-Einzel- und Großhandel, Nonfood-Einzel- und Großhandel, Ladenpassagen Pressungen bis 2 bis 6 N/mm ²	3
Bruchkraft 5.000 – 8.000 N Gewerbe und Industrie; Anwendungsbereiche wie Gruppe 3, jedoch befahrbar mit Polyamidrollen Pressungen 6 bis 20 N/mm ²	4
Bruchkraft über 8.000 N Gewerbe und Industrie; Schwerlastbereiche mit Flurförderfahrzeugverkehr mit Polyamidrollen; Kollern von Metallteilen, wie z. B. in Fabrikations-, Montage- und Lagerhallen, Reparaturwerkstätten für Maschinen und schweres Gerät Pressungen > 20 N/mm ²	5

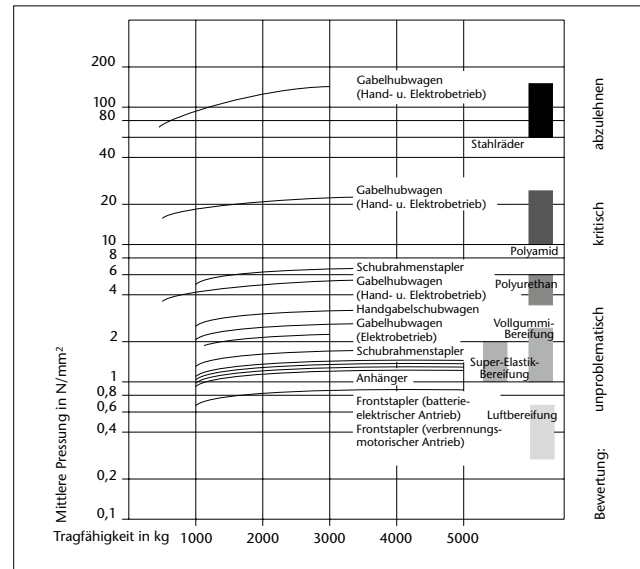

Bodenpressung in N/mm² von Flurfördermitteln nach einer Untersuchung der FMPA in Stuttgart

Die Tabelle verdeutlicht die Beanspruchungen und gibt Hinweise zum Einfluss der Bereifungsart: Stahlräder sind abzulehnen und Polyamid (Nylon + Perlon) weniger günstig. Weichere Bereifungen (≤ 75 Shore-A-Härte) sowie größere Raddurchmesser und breitere Auflagen sind besonders vorteilhaft.

Wichtiger Hinweis:

Bei den „Einsatzmöglichkeiten“ kann es sich naturgemäß nur um eine Empfehlung handeln, da hier Art und Qualität der Verlegung entscheidend sind: Unsere Empfehlung beruht auf üblicher, fachgerechter Verlegung. Mit zunehmender mechanischer Belastung sowie härterer Bereifung ist eine höhere Fliesendicke erforderlich.

Mechanische Belastbarkeit

Die Deutsche Steinzeug bietet Fliesen und Platten in Dicken von 5 bis hin zu 20 mm auch für extreme Belastungen in Industrie und Gewerbe an.

Die Bruchlastwerte unserer Produkte liegen teils erheblich über denen, die die DIN EN 14411 fordert (Entsprechende Prüfzeugnisse werden auf Anforderung zur Verfügung gestellt).

Die ermittelte Bruchlast gibt Aufschluss über die Eignung für mechanisch belastbare Böden. Die Beanspruchung selbst erfolgt mehr auf Biegung als auf Druck. Die „Überstarken“ aus unserem Programm mit ihren hohen Druck-, Bruch- und Biegefestigkeitswerten sind der ideale Belag für hochbelastete Böden. Sie widerstehen den Rädern von Flurförderfahrzeugen, Gabelstaplern und Hubwagen mit ihren hohen Bodenpressungen. Besonders sind sie geeignet für die Industrie-Logistik, Groß- und Supermarktböden.

3. Druckfestigkeit

Die Druckfestigkeit von Fliesen und Platten ist nicht genormt. Sie erreicht bei Steinzeugfliesen Werte bis zu 150 N/mm². Die folgende Umrechnungstabelle zeigt die Wichtigkeit einer optimalen und fachgerechten Einbettung der Fliesen vor Ort. Die relativ schwachen Werte von Zement- und Dünnbettmörtel können nur durch eine besondere und fachgerechte Verlegung (Mörtelzusammensetzung, Wasser/Zementwert und manuelle bzw. mechanische Verdichtung) kompensiert werden.

4. Schlagfestigkeit, DIN EN ISO 10545-5

Rückprallmessung an 5 Mustern.

5. Tiefenverschleiß, DIN EN ISO 10545-6

Beim Tiefenverschleiß unglasierter Fliesen und Platten wird mittels Schmelzkorund und einer Schleifscheibe die Abrasion ermittelt. Je niedriger der Wert, desto verschleißfester das Material.

6. Glasurabrieb, DIN EN ISO 10545-7

Die **Verschleißklasse** glasierter Fliesen und Platten wird im Nasstest ermittelt. Mittels Schmelzkorund und Stahlkugeln sowie Wasserzugabe in einem exzentrisch kreisenden System wird künstlich Abrieb erzeugt. Die Anzahl der Umdrehungen bei sichtbarer Veränderung der Verschleißfläche ergibt die Klassifizierung:

Widerstand gegen Oberflächenverschleiß	
Klasse	Umdrehungen
0	100
1	150
2	600
3	750/1500
4	2100/6000/12000
5	>12000*

* Muss die Fleckenprüfung nach DIN EN ISO 10545-14 bestehen.

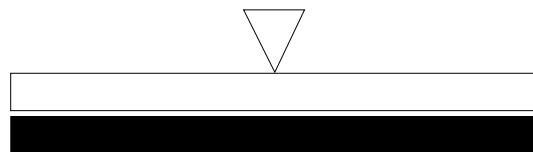

Steinzeug hat eine ca. 10-20 fach höhere Druckfestigkeit als Zementmörtel, Estrich und Stahlbeton.

Umrechnungstabelle verschiedener Materialien

Materialarten	N/mm ²	N/cm ²	kN/cm ²
Steinzeugfliesen	100 – 150	10.000 – 15.000	10 – 15
Steinzeug- und Spaltplatten	180 – 250	18.000 – 25.000	18 – 25
Zementmörtel Gr. III	10	1.000	1
Zementmörtel hochwertig	20	2.000	2
Dünnbettmörtel	15 – 30	1.500 – 3.000	1,5 – 3
Epoxidharze	60 – 75	6.000 – 7.500	6 – 7,5
Zementestrich CT, C12 (ZE 12)	12	1.200	1,2
CT, C20 (ZE 20)	20	2.000	2
CT, C30 (ZE 30)	30	3.000	3
Hartstoffestrich 65	65	6.500	6,5
Stahlbeton C 20/25 (B 25)	25	2.500	2,5
C 30/37 (B 35)	35	3.500	3,5

Klasse 0

Glasierte Fliesen und Platten dieser Klasse werden nicht zur Herstellung vom Bodenbelägen empfohlen.

Klasse 1

Bodenbeläge in Bereichen, die hauptsächlich mit Schuhen mit weicher Sohle oder barfuß ohne kratzende Verschmutzung begangen werden (z. B. Wohnbäder und Schlafzimmer ohne direkten Zugang von außen).

Klasse 2

Bodenbeläge in Bereichen, die mit weichen besohlenen oder normalen Schuhen mit höchstens geringen Mengen kratzender Verschmutzungen gelegentlich begangen werden (z. B. Räume in Wohnbereichen von Häusern, mit Ausnahme von Küchen, Eingängen und ähnlichen Räumen, die häufig begangen werden). Dies gilt nicht für Sonderfußbekleidung z. B. Nagelschuhe.

Klasse 3

Bodenbeläge in Bereichen, die mit normalen Schuhen häufig mit geringen Mengen kratzender Verschmutzung begangen werden (z. B. Wohnküchen, Flure, Korridore, Balkone, Loggien und Terrassen). Dies gilt nicht für Sonderfußbekleidung z. B. Nagelschuhe.

Klasse 4

Bodenbeläge, die bei regelmäßiger Nutzung mit geringen Mengen kratzender Verschmutzung begangen werden, so dass die Beanspruchungen stärker sind als bei Klasse 3 (z. B. gewerbliche Küchen, Hotels, Ausstellungs- und Verkaufsräume).

Klasse 5

Bodenbeläge, die durch starken Fußgängerverkehr über lange Zeiträume mit geringen Mengen kratzender Verschmutzung beansprucht werden, so dass die Beanspruchungen die äußersten sind, unter denen glasierte Fliesen und Platten anwendbar sein können (z. B. öffentliche Bereiche wie Einkaufszentren, Eingangshallen auf Flughäfen, Hotelfoyers, öffentliche Fußwege und industrielle Anwendungen).

Jeder genutzte Bodenbelag unterliegt dem Verschleiß. Dieser ist abhängig vom Anwendungsbereich und der Häufigkeit der Begehung, von Art und Grad der Verschmutzung, sowie Härte und Verschleißfestigkeit des Belagsmaterials. Während unglasierte Steinzeugbodenfliesen praktisch keine Anwendungseinschränkungen erfordern, sind glasierte Bodenfliesen und -platten nach Beanspruchungsgruppen zu unterscheiden. Abstreifer, Matten und dergleichen ermöglichen es, Schmutz und Verschleißmittel abzustreifen und vom glasierten Bodenbelag fernzuhalten. Eine derartige Schmutzschleuse muss besonders für solche Räume vorgesehen werden, die direkt von der Straße oder vom Garten her zugänglich sind.

Extreme Beanspruchung

Dafür empfehlen wir die Verwendung von durchgefärbten, unglasierten Fliesen und Platten, die in einer Vielzahl von Farben und Formaten zur Verfügung stehen. Beispiele: Böden mit starkem Publikumsverkehr, wie z. B. in Supermärkten, Hotels, Schulen, Verwaltungsgebäuden, Bahnhöfen, Krankenhäusern, Passagen usw. unter Berücksichtigung mechanischer Beanspruchung.

7. Ausdehnungskoeffizient, DIN EN ISO 10545-8

Der Ausdehnungskoeffizient wird zwischen Raumtemperatur und 100°C ermittelt. Gemessene Werte liegen um ca. $6,0 \times 10^{-6} \text{ m}/(\text{m}\cdot\text{K})$ bei Steinzeug und ca. $8,0 \times 10^{-6} \text{ m}/(\text{m}\cdot\text{K})$ bei Feinsteinzeug. Bei 8 m Länge und 50° Temperaturdifferenz ergeben sich somit bei Steinzeug ca. 2,4 mm Längenänderung (bei Estrich/Beton, 4,6 mm und Stahl 5,6 mm).

8. Temperaturwechselbeständigkeit, DIN EN ISO 10545-9

Die Temperaturwechselbeständigkeit wird zwischen 15° und 145° geprüft.

9. Feuchtedehnung, DIN EN ISO 10545-10

Die Feuchtedehnung wird zwischen getemperten und wasser-gesättigten Proben ermittelt.

10. Glasurrissefreiheit, DIN EN ISO 10545-11

Diese Prüfung erfolgt im Autoklaven bei 500 kPa mit anschließender Kontrolle nach Einfärbung.

Glasuren mit Haarrissen/Craquele werden als solche gekennzeichnet und erfordern ein Vormäßen des Belages vor dem Verfugen, um Ablagerungen von feinen Partikeln des Fugmörtels in den Haarrissen vorzubeugen. Farbige Fugmassen eignen sich hierbei nicht. Die Glasuroberflächen dürfen nicht mit Filzstift etc. beschrieben werden.

11. Wärmeleitfähigkeit u.ä.

Wärmeleitfähigkeit, -abstrahlung, -speicherfähigkeit und -durchlasswiderstand sind nicht genormt. Bei Steinzeug ergeben sich folgende ca.-Werte:

Wärmeleitfähigkeit:	1 W/mK	Wärmespeicherfähigkeit:	0,8 kJ/kgK
Wärmeabstrahlung:	5,3 W/m ² K ⁴	Wärmedurchlasswiderstand:	0,01 m ² K/W

12. Ableitwiderstand

Mit einem Durchgangswiderstand von $> 10^{10} \text{ Ohm}$ (DIN EN 1081) ist unsere Keramik im trockenen Zustand isolierend. Wir bieten jedoch mit den Serien Eladuct und KerAion ELA 10.6 Keramik für elektrisch ableitfähige Fußböden an. Die Glasur der ELA 10.6 weist einen Oberflächenwiderstand von ca. 10^6 Ohm nach DIN EN 1081 auf. Die Ableitung elektrischer Ladungen erfolgt von der Glasur über leitfähig auszuführende Fugen und Fliesenkleber in elektrisch zu erdende Kupferleitbahnen, die auf dem zu fliesenden Untergrund verlegt werden. Bei Eladuct ist der komplette Plattenkörper ableitfähig. Der Durchgangswiderstand nach DIN EN 1081 beträgt ca. 10^8 Ohm . Leitfähige Fugen erübrigen sich hier, ansonsten ist der Unterbau auszuführen wie für ELA 10.6 beschrieben!

13. Dampfdiffusionswiderstand

Der Wasserdampfdiffusionswiderstand ist nach DIN EN ISO 12572 ca. $\mu 120.000$ bei Steinzeug/Spaltplatten und $\mu 100.000$ bei Steingut (ohne Fugenanteile).

14. Frostbeständigkeit, DIN EN ISO 10545-12

Die Frostbeständigkeitsprüfung erfolgt an 10 Stück bzw. $> 0,25 \text{ m}^2$ Proben. Nach einer Wassersättigung unter Vakuum wird nach 100 Frost-Tau-Wechseln die Unversehrtheit geprüft.

Die Frostbeständigkeit eines Außenbelages ist jedoch nicht allein von der Güte der verwendeten keramischen Fliesen und Platten abhängig. **Eine fachgerechte Konstruktion und Verlegung sind zwingend.** Beachten Sie dazu bitte unsere Ausschreibungstexte und das Merkblatt des Zentralverbandes des Deutschen Baugewerbes „Belagskonstruktionen mit Fliesen und Platten außerhalb von Gebäuden“.

15. Licht- und Farbechtheit

Sowohl glasierte als auch unglasierte Keramik ist auf Dauer licht- und farbecht gemäß DIN 51094.

16. Hellbezugswert

Der Hellbezugswert einer Fliese/Platte beschreibt die Helligkeit der Oberfläche, wie sie das menschliche Auge empfindet. Der Messwert $Y = 100$ entspricht hierbei der Helligkeit einer absolut weißen Fläche und $Y = 0$ der einer absolut schwarzen Fläche. Der Hellbezugswert wird bei Unifliesen/-platten ermittelt.

17. Brandverhalten

Keramische Fliesen und Platten entsprechen gemäß EN ISO 13501-1 und DIN EN 14411 der Klasse A1. Sie sind demnach grundsätzlich unbrennbar und somit feuerhemmend. Auch im Brandfall geben sie keine toxischen Emissionen frei.

Chemische Eigenschaften

1. Chemische Beständigkeit, DIN EN ISO 10545-13

Beständigkeit gegen Haushaltschemikalien und Badewasserzusätze

- Haushaltchemikalien
Ammoniumchloridlösung 100g/l
- Schwimmbadsalze
Natriumhypochloridlösung 20mg/l

Klassen

A/B/C*

Beständigkeit gegen Säuren und Laugen

- Geringe Konzentration (L)
 - a) Salzsäurelösung 3% (V/V)
 - b) Zitronensäurelösung 100g/l
 - c) Kaliumhydroxidlösung 30g/l
- Hohe Konzentration (H)
 - a) Salzsäurelösung 18% (V/V)
 - b) Milchsäurelösung 5% (V/V)
 - c) Kaliumhydroxidlösung 100g/l

Klassen

LA/LB/LC bzw. HA/HB/HC*

Säureschutzbau und Apparatebau

Die Beständigkeit für den Säureschutzbau DIN EN 993-16 oder den chem. Apparatebau DIN 28062 ist Einzelprüfungen vorbehalten.

* Klasse A weist hierbei die höchste chemische Beständigkeit auf, die nach C immer mehr abnimmt.

2. Fleckbeständigkeit, DIN EN ISO 10545-14

Fleckenbildner

- Spurenbildende Fleckenbildner
Grüne Fleckenbildner in Öl
Rote Fleckenbildner in Öl
- Fleckenbildner chemisch
Jod, 13g/l in Alkohol
- Filmbildende Fleckenbildner
Olivenöl

Reinigung (im Rahmen der Prüfung)

- Reinigungsmittel
Heißes Wasser (+55 °C)
Schwaches Reinigungsmittel
Starkes Reinigungsmittel
- Lösungsmittel
Salzsäurelösung 3% (V/V)
Kaliumhydroxid 200g/l
Aceton

Klassen

Kl. 5 / Kl. 4 / Kl. 3 / Kl. 2 / Kl. 1 *

3. Blei- und Cadmiumabgabe

Die glasierten Oberflächen werden einer 4%igen Essigsäure-Lösung ausgesetzt. Anschließend wird die Menge des abgegebenen Bleis und Cadmiums bestimmt.

* Klasse 5 weist hierbei die höchste Fleckbeständigkeit auf, die nach 1 immer mehr abnimmt.

Oberflächenveredelungen und -vergütungen

Hytect

Hytect ist eine hochwirksame und dauerhafte Veredelung von Fliesen und Platten der Deutschen Steinzeug. Die eingebrannte Veredelung auf der Basis von Titandioxid wirkt nach dem Prinzip der Photokatalyse. Es ergeben sich folgende Nutzer-Vorteile:

A) Hytect zersetzt Bakterien und Keime

Unter dem Einfluss von Sonnenlicht oder künstlicher Beleuchtung wird die Oberfläche reaktiv. Es erfolgt die Bildung von aktiviertem Sauerstoff. Dieser zersetzt Mikroorganismen.

B) Hytect baut störende Gerüche ab

Auch störende, lästige oder sogar gesundheitsschädliche Geruchsstoffe in der Luft werden durch Hytect abgebaut.

C) Hytect vermindert den Reinigungsaufwand

Die hydrophile Oberfläche bewirkt die Unterwanderung des Schmutzes durch Wasser. Somit ergibt sich eine erhebliche Reduzierung von Reinigungsmitteln, d. h. Kosteneinsparung und Umweltschutz, sowie ein geringerer manueller Zeitaufwand.

Hytect-Oberflächen sind geruchsneutral, ungiftig, entsprechen Lebensmittelanforderungen und sind für Allergiker unbedenklich.

Für die Verlegung und Verfugung ergeben sich keine Änderungen zu den üblichen Verfahrensweisen. Als Reiniger sind die üblichen Mittel (ohne Flusssäure und deren Verbindungen) anwendbar. Ausgenommen sind alle filmbildenden, rückfettenden oder imprägnierenden Zusätze, welche die Oberflächenaktivierung durch Licht stören.

Namhafte Institute im In- und Ausland haben uns die entsprechenden Wirkungsweisen von Hytect bestätigt.

Protecta-Oberflächenvergütung



Das Bessere ist der Feind des Guten...

Unglasierte Steinzeugfliesen sind grundsätzlich strapazierfähig und unempfindlich. Mit der keramischen Vergütung Protecta wird die Flecken- und Schmutzunempfindlichkeit nochmals entscheidend verbessert. Die **werkseitig** aufgebrachte Vergütung geht während des Brennens eine innige Verbindung mit dem Fliesenkörper ein und verschließt die bei unglasierter Keramik quo natura vorhandenen „Mikro-Poren“. Dadurch wird das Eindringen fleckbildender Substanzen verhindert. Eine Imprägnierung ist hier nicht mehr erforderlich und bei trittsicheren Protecta-vergüteten Fliesen unter Umständen sogar schädlich, da das Imprägniermittel nicht in die Fliese eindringen kann, sondern als Schmierfilm auf der Oberfläche verbleibt.

Protecta-vergütete Produkte sind bei den entsprechenden Serien mit dieser Bildmarke gekennzeichnet:



Hygiene

Glasierte sowie Protecta-vergütete Fliesen und Platten der Deutschen Steinzeug liefern die besten hygienischen Voraussetzungen. Durch die geschlossene Oberfläche bieten Sie keine Möglichkeit zum Keimwachstum. Untersuchungen von Hygiene-Instituten bestätigen die Eignung für die Auskleidung von Trinkwasserbehältern. Übersensible Personen wie Allergiker machen mit Fliesen und Platten beste Erfahrungen.

Reinigung

Grundsätzlich sind Bekleidungen und Beläge vor intensiven Verschmutzungen, welche insbesondere durch Folgegewerke des Bauablaufs (Malerarbeiten o. ä.) entstehen können, durch geeignete Maßnahmen zu schützen.

Die Reinigung unserer Fliesen und Platten erfolgt üblicherweise mit Wasser und einem neutralen oder alkalischen Reinigungsmittel. Bei hartem Wasser ist sporadisch der Einsatz von sauren Reinigern erforderlich. Bei Fleckenverunreinigungen ist die Reinigung von der Art der Flecken abhängig und mit geeigneten Chemikalien durchzuführen.

Ein Nachwischen mit klarem Wasser ist bei höherer Konzentration des eingesetzten Reinigungsmittels erforderlich. Bei Grundreinigungen ist ein Klarspülen unbedingt nötig. Pflegemittelhaltige Reiniger lehnen wir ab. Sie vermindern üblicherweise die Trittsicherheit und führen zu einem negativen optischen Erscheinungsbild des Bodenbelags durch Aufbau entsprechender Schichten! Achtung: Bei Bestückung von Reinigungsmaschinen mit Pads, die Schleifkorn enthalten, kommt es zu einem Poliervorgang durch den die Trittsicherheit der Fliesen und Platten erheblich reduziert wird. Wir lehnen deshalb solche Methoden ausdrücklich ab. Flusssäure oder deren Verbindungen greifen die Keramik an und führen zu einer irreversiblen Schädigung!

Eine ausführliche Reinigungsanleitung für keramische Fliesen finden Sie im Internet unter www.agrob-buchtal.de

→ Service

→ Architekten & Planer/Fachhändler/Fliesenleger

→ Reinigungsanleitung.

Imprägnierung

Unglasiertes Steinzeug, das nicht Protecta-vergütet oder Hytect ist, sollte imprägniert werden, um das Eindringen gefärbter Flüssigkeiten, sowie von Fetten und Ölen zu verhindern und die Reinigung zu erleichtern.

Die Imprägnierung ist auf sauberen und trockenen Böden aufzubringen, Überschüsse sind sofort zu entfernen.

Trittsicherheit

1. Reibungskoeffizient/Trittsicherheit/Rutschhemmung

Die Arbeitsstättenverordnung und die Unfallverhütungsvorschriften verlangen, dass Fußböden eben, rutschhemmend und reinigungsfreundlich sein müssen. Besondere Schutzmaßnahmen gegen Ausgleiten sind erforderlich, wenn durch den Umgang mit Wasser, Öl, Schlamm, Fett oder Abfällen Rutschgefahr besteht. Bei der Auswahl der Belagstoffe ist darauf Rücksicht zu nehmen. Diese klare Forderung stützt sich auf Untersuchungen der Versicherungsträger, die ergaben, dass unter allen Unfallursachen das Ausrutschen an erster Stelle steht.

1.1. Gewerbebereiche

Zuständig: Deutsche Gesetzliche Unfallversicherung, Mittelstraße 51, 10117 Berlin-Mitte, Telefon: +49-30-28876-3800, Fax: -3808, www.dguv.de, info@dguv.de

Prüfnorm: DIN 51130.

Merkblatt: DGUV-Regel 108-003 „Fußböden in Arbeitsräumen und Arbeitsbereichen mit Rutschgefahr.“ (bisherige BGR 181)

Prüfverfahren: Schiefe Ebene, Begehung mit Sicherheitsschuhen, Gleitmedium Öl.

Die Oberflächengestaltung kann eben, feinrau, rau oder profiliert sein.

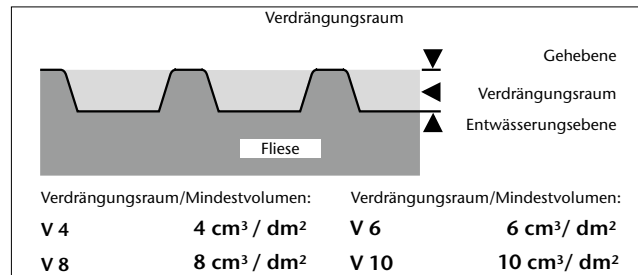

Der Verdrängungsraum (V4-V10) ist der offene Hohlraum zwischen oberer Geh- und Entwässerungsebene bei profilierten Oberflächen.

Bewertungsgruppen

Die geforderten Bewertungsgruppen sind in einer detaillierten Tabelle gleitgefährdeter Arbeitsbereiche zusammengestellt (siehe nächste Seite). Die Deutsche Gesetzliche Unfallversicherung und Agrob Buchtal geben Auskunft.

Test auf „Schiefer Ebene“

Bewertungs-Gruppen	Neigungswinkel	Gewerbebereich
R9	> 6°- 10° geringer Haftreibwert	
R10	> 10°- 19° normaler Haftreibwert	
R11	> 19°- 27° erhöhter Haftreibwert	
R12	> 27°- 35° großer Haftreibwert	
R13	> 35° sehr großer Haftreibwert	

Die angegebenen Neigungswinkel dienen ausschließlich zur Zuordnung der Bewertungsgruppen und sind nicht mit den Neigungswinkeln von Schrägen/Rampen gleichzusetzen.

Trittsichere Fliesen sind bei den entsprechenden Serien mit dem Logo „GRIP“ gekennzeichnet:



Gesetzesgrundlage

Die Arbeitsstättenverordnung als auch die Unfallverhütungsvorschriften verlangen, dass Fußböden eben, rutschhemmend und leicht zu reinigen sein müssen. Detaillierte Anforderungen enthält die „Technische Regel für Arbeitsstätten“ ASR. A 1.5/1,2 „Fußböden“

Herausgeber:

Bundesanstalt für Arbeitsschutz und Arbeitsmedizin (Ausschuss für Arbeitsstätten)

Bezugsquelle:

Download unter www.baua.de

0 Allgemeine Arbeitsräume und -bereiche*

0.1	Eingangsbereiche, innen**)	R9
0.2	Eingangsbereiche, außen	R11 (oder R10 V4)
0.3	Treppen, innen***)	R9
0.4	Außentreppen	R11 (oder R10 V4)
0.5	Schrägrampen, innen***) (z. B. Rollstuhlrampen, Ausgleichsschragen, Transportwege)	Eine R-Gruppe höher als für den Zugangsbelag erforderlich Zugangsbelag, falls zutreffend
0.6	Sanitärräume	
0.6.1	Toiletten	R9
0.6.2	Umkleide- und Waschräume)	R10
0.7	Pausenräume (z.B. Aufenthaltsraum, Betriebskantinen)	R9
0.8	Erste-Hilfe-Räume und vergleichbare Einrichtungen (siehe ASR A4.3)	R9

1 Herstellung von Margarine, Speisefett, Speiseöl

1.1	Fettschmelzen	R13 V6
1.2	Speiseölraffinerie	R13 V4
1.3	Herstellung und Verpackung von Margarine	R12
1.4	Herstellung und Verpackung von Speisefett, Abfüllen von Speiseöl	R12

2 Milchbe- und -verarbeitung, Käseherstellung

2.1	Frischmilchverarbeitung einschließlich Buttereier	R12
2.2	Käsefertigung, -lagerung und Verpackung	R11
2.3	Speiseeisfabrikation	R12

3 Schokoladen- und Süßwarenherstellung

3.1	Zuckerkocherei	R12
3.2	Kakaoherstellung	R12
3.3	Rohmassenherstellung	R11
3.4	Eintafelei, Hohlkörper- und Pralinenfabrikation	R11

4 Herstellung von Backwaren

(Bäckereien, Konditoreien, Dauerbackwaren-Herstellung)		
4.1	Teigbereitung	R11
4.2	Räume, in denen vorwiegend Fette oder flüssige Massen verarbeitet werden	R12
4.3	Spülräume	R12 V4

5 Schlachtung, Fleischbearbeitung, Fleischverarbeitung

5.1	Schlachthaus	R13 V10
5.2	Kuttlerraum, Darmschleimerei	R13 V10
5.3	Fleischzerlegung	R13 V8
5.4	Wurstküche	R13 V8
5.5	Kochwurstabteilung	R13 V8
5.6	Rohwurstabteilung	R13 V6
5.7	Wursttrockenraum	R12
5.8	Darmlager	R12
5.9	Pökelei, Räucherei	R12
5.10	Geflügelverarbeitung	R12 V6
5.11	Aufschnitt- und Verpackungsabteilung	R12
5.12	Handwerksbetrieb mit Verkauf	R12 V8 ****)

6 Be- und Verarbeitung von Fisch, Feinkostherstellung

6.1	Be- und Verarbeitung von Fisch	R13 V10
6.2	Feinkostherstellung	R13 V6
6.3	Mayonnaiseherstellung	R13 V4

7 Gemüsebe- und -verarbeitung

7.1	Sauerkrautherstellung	R13 V6
7.2	Gemüsekonservenherstellung	R13 V6
7.3	Sterilisierräume	R11
7.4	Räume, in denen Gemüse für die Verarbeitung vorbereitet wird	R12 V4

8 Nassbereiche bei der Nahrungsmittel- und Getränkeherstellung

(soweit nicht besonders erwähnt)		
8.1	Lagerkeller, Gärkeller	R10
8.2	Getränkeabfüllung, Fruchtsaftherstellung	R11

9 Küchen, Speiseräume

9.1	Gastronomische Küchen (Gaststättenküchen, Hotelküchen)	R12
9.2	Küchen für Gemeinschaftsverpflegung in Heimen, Schulen, Kindertageseinrichtungen, Sanatorien	R11
9.3	Küchen für Gemeinschaftsverpflegung in Krankenhäusern, Kliniken	R12
9.4	Großküchen für Gemeinschaftsverpflegung in Mensen, Kantinen und Fernküchen	R12 V4

9.5	Aufbereitungsküchen (Fast Food-Küchen, Convenience- und Imbissbetriebe))	R12
9.6	Auftau- und Anwärnküchen	R10
9.7	Kaffee- und Teeküchen, Küchen in Hotels-Garni, Stationsküchen	R10
9.8	Spülräume	
9.8.1	Spülräume zu 9.1, 9.4, 9.5	R12 V4
9.8.2	Spülräume zu 9.2	R11
9.8.3	Spülräume zu 9.3	R12
9.9	Speiseräume, Gasträume, Kantinen einschließlich Serviergängen	R9

10 Kühlräume, Tiefkühlräume, Kühlhäuser, Tiefkühlhäuser

10.1	für unverpackte Ware	R12
10.2	für verpackte Ware	R11

11 Verkaufsstellen, Verkaufsräume

11.1	Warenannahme Fleisch	
11.1.1	für unverpackte Ware	R11
11.1.2	für verpackte Ware	R10
11.2	Warenannahme Fisch	R11
11.3	Bedienungsgang für Fleisch und Wurst	
11.3.1	für unverpackte Ware	R11
11.3.2	für verpackte Ware	R10
11.4	Bedienungsgang für Brot und Backwaren, unverpackte Ware	R10
11.5	Bedienungsgang für Molkerei- und Feinkosterzeugnisse, unverpackte Ware	R10
11.6	Bedienungsgang für Fisch	
11.6.1	für unverpackte Ware	R12
11.6.2	für verpackte Ware	R11
11.7	Bedienungsgänge, ausgenommen Nr. 11.3 bis 11.6	R9
11.8	Fleischvorbereitungsraum	
11.8.1	zur Fleischbearbeitung, ausgenommen Nr. 5	R12 V8
11.8.2	zur Fleischverarbeitung, ausgenommen Nr. 5	R11
11.9	Blumenbinderäume und -bereiche	R11
11.10	Verkaufsbereiche mit Backöfen	
11.10.1	zum Herstellen von Backware	R11
11.10.2	zum Aufbacken vorgefertigter Backware	R10
11.11	Verkaufsbereiche mit Fritteusen oder Grillanlagen	R12 V4
11.12	Verkaufsräume, Kundenräume	R9
11.13	Vorbereitungsbereiche für Lebensmittel zum SB-Verkauf	R10
11.14	Kassenbereiche, Packbereiche	R9
11.15	Verkaufsbereiche im Freien	R11 (oder R10 V4)

12 Räume des Gesundheitsdienstes/der Wohlfahrtspflege

12.1	Desinfektionsräume (nass)	R11
12.2	Vorreinigungsbereiche der Sterilisation	R10
12.3	Fäkalienräume, Ausgussräume, unreine Pflegearbeitsräume	R10
12.4	Sektionsräume	R10
12.5	Räume für medizinische Bäder, Hydrotherapie, Fango-Aufbereitung	R11
12.6	Waschräume von OP's, Gipsräume	R10
12.7	Sanitäre Räume, Stationsbäder	R10
12.8	Räume für medizinische Diagnostik und Therapie, Messageräume	R9
12.9	OP-Räume	R9
12.10	Stationen mit Krankenzimmern und Flure	R9
12.11	Praxen der Medizin, Tageskliniken	R9
12.12	Apotheken	R9
12.13	Laborräume	R9
12.14	Friseursalons	R9

13 Wäscherei

13.1	Räume mit Durchlaufwaschmaschinen (Waschröhren) oder mit Waschscheudermaschinen	R9
13.2	Räume mit Waschmaschinen, bei denen die Wäsche tropfnass entnommen wird	R11
13.3	Räume zum Bügeln und Mangeln	R9

14 Kraftfutterherstellung

14.1	Trockenfutterherstellung	R11
14.2	Kraftfutterherstellung unter Verwendung von Fett und Wasser	R11 V4

15 Lederherstellung, Textilien

15.1	Wasserwerkstatt in Gerbereien	R13
15.2	Räume mit Entfleischmaschinen	R13 V10
15.3	Räume mit Leimlederanfall	R13 V10
15.4	Fetträume für Dichtungsherstellung	R12
15.5	Färbereien für Textilien	R11

16 Lackierereien

16.1	Nassschleifbereiche	R12 V10
16.2	Pulverbeschichtung	R11
16.3	Lackierung	R10

17 Keramische Industrie

17.1	Nassmühlen (Aufbereitung keramischer Rohstoffe)	R11
17.2	Mischer, Umgang mit Stoffen wie Teer, Pech, Graphit, Kunstharzen	R11 V6
17.3	Pressen (Formgebung), Umgang mit Stoffen wie Teer, Pech, Graphit, Kunstharzen	R11 V6
17.4	Gieß-, Druckgussbereiche	R12
17.5	Glazierbereiche	R12

18	Be- und Verarbeitung von Glas und Stein			
18.1	Steinsägerei, Steinschleiferei	R11		*) Für Fußböden in barfuß begangenen Nassbereichen siehe DGUV-Information 207-006 „Bodenbeläge für nassbelastete Barfußbereiche“ (bisherige GUV-I 8527)
18.2	Glasformung von Hohlglas, Behälterglas	R11		
18.3	Schleifereibereiche für Hohlglas, Flachglas	R11		
18.4	Isolierglasfertigung, Umgang mit Trockenmittel	R11 V6		
18.5	Verpackung, Versand von Flachglas, Umgang mit Antihafmittel	R11 V6		
18.6	Ätz- und Säurepolieranlagen für Glas	R11		
19	Betonwerke			
19.1	Betonwaschplätze	R11		**) Eingangsbereiche gemäß Nummer 0.1 sind die Bereiche, die durch Eingänge direkt aus dem Freien betreten werden und in die Feuchtigkeit von außen hereingetragen werden kann (siehe auch Punkt 6 Absatz 3, Verwendung von Schmutz- und Feuchtaufnehmer). Für anschließende Bereiche oder andere großflächige Räume ist Punkt 4 Abs. 10 der ASR A1.5/1,2 zu beachten.
20	Lagerbereiche			***) Treppen und Rampen gemäß Nummer 0.3 und 0.5 sind diejenigen, auf die Feuchtigkeit von außen hineingetragen werden kann. Für anschließende Bereiche ist Punkt 4 Abs. 10 der ASR A1.5/1,2 zu beachten.
20.1	Lagerräume für Öle und Fette	R12 V6		****) Wurde überall ein einheitlicher Bodenbelag verlegt, kann der Verdrängungsraum auf Grund einer Gefährdungsbeurteilung (unter Berücksichtigung des Reinigungsverfahrens, der Arbeitsabläufe und des Anfalls an gleitfördernden Stoffen auf den Fußboden) bis auf V 4 gesenkt werden.
20.2	Lagerräume für verpackte Lebensmittel	R10		
20.3	Lagerbereiche im Freien	R11 (oder R10 V4)		
21	Chemische und thermische Behandlung von Eisen und Metall			*****) Die Fußgängerbereiche, die nicht von Rutschgefahr durch Witterungseinflüsse, wie Schlagregen oder eingeschleppte Nässe, betroffen sind.
21.1	Beizeereien	R12		Fußböden in Räumen dürfen keine Unebenheiten, Vertiefungen, Stolperstellen oder gefährlichen Schrägen aufweisen.
21.2	Härtereien	R12		
21.3	Laborräume	R11		
22	Metallbe- und -verarbeitung, Metall-Werkstätten			Fußböden sollen ohne Neigung angelegt werden. Ausgenommen sind funktionelle Neigungen, z. B. zur Ableitung von Flüssigkeiten.
22.1	Galvanisierräume	R12		In Bereichen, die im Rahmen ihrer üblichen Nutzung durchgehend begangen werden müssen, dürfen sich die Fußbodenoberflächen hinsichtlich ihrer Rutschhemmung nicht so voneinander unterscheiden, dass es zu Stolper- und Rutschgefahren kommen kann. Dies kann gegeben sein, wenn sich die Oberflächenbeschaffenheiten innerhalb eines Fußbodens (z. B. bei Abdeckungen, Markierungen oder aufgeklebten Folien) oder von angrenzenden Fußböden hinsichtlich der Rutschhemmung um mehr als eine R-Gruppe unterscheiden.
22.2	Graugussbearbeitung	R11 V4		
22.3	Mechanische Bearbeitungsbereiche (z. B. Dreherei, Fräseerei), Stanzei, Presserei, Zieherei (Rohre, Drähte) und Bereiche mit erhöhter Öl-Schmiermittelbelastung	R11 V4		
22.4	Teilreinigungsbereiche, Abdämpfbereiche	R12		
23	Werkstätten für Fahrzeug-Instandhaltung			Gebäudeeingänge sind so einzurichten, dass der Eintrag von Schmutz und Nässe nicht zu Rutschgefahren führt. Dies kann durch Sauberlaufzonen in Form von Schmutz- und Feuchtaufnehmern erreicht werden, die hinsichtlich ihrer Länge, Breite und des Materials auf den zu erwartenden Personenverkehr ausgelegt sind und in ihrer Laufrichtung über die gesamte Durchgangsbreite mindestens 1,5 m lang sind.
23.1	Instandsetzungs- und Wartungsräume	R11		
23.2	Arbeits- und Prüfgrube	R12 V4		
23.3	Waschhalle, Waschplätze	R11 V4		Sofern Flüssigkeiten oder gleitfördernde Stoffe in einem solchen Umfang auf den Fußboden gelangen, dass dadurch eine Rutschgefahr für Personen besteht, sind geeignete Maßnahmen zu ergreifen. Fließfähige Flüssigkeiten lassen sich beispielsweise durch ein ausreichendes Fußbodengefälle abführen (z. B. ein Gefälle von mindestens 2 Prozent bei Flüssigkeiten mit wasserähnlichen Fließeigenschaften). Das Ableiten von Flüssigkeiten über Verkehrswege ist nach Möglichkeit zu vermeiden. Eine geeignete Maßnahme gegen die Ausrutschgefahr aufgrund gleitfördernder Stoffe, z. B. Öl oder Speisereste, sind Bodenbeläge mit ausreichendem Verdrängungsraum.
24	Werkstätten für das Instandhalten von Luftfahrzeugen			
24.1	Flugzeughallen	R11		
24.2	Werfthallen	R12		
24.3	Waschplätze	R11 V4		
25	Abwasserbehandlungsanlagen			
25.1	Pumpenräume	R12		
25.2	Räume für Schlammmentwässerungsanlagen	R12		
25.3	Räume für Rechenanlagen	R12		
25.4	Standplätze von Arbeitsplätzen, Arbeitsbühnen und Wartungspodeste	R12		
26	Feuerwehrrhäuser			
26.1	Fahrzeug-Stellplätze	R12		
26.2	Räume für Schlauchpflegeeinrichtungen	R12		
27	Funktionsräume in der Atemschutz Übungsanlage			
27.1	Vorbereitungsraum	R10		
27.2	Konditionsraum	R10		
27.3	Übungsraum	R11		
27.4	Schleuse	R10		
27.5	Zielraum	R11		
27.6	Wärmegewöhnungsraum	R11		
27.7	Leitstand	R9		
28	Schulen und Kindertageseinrichtungen			
28.1	Eingangsbereiche, Flure, Pausenhallen	R9		
28.2	Klassenräume, Gruppenräume	R9		
28.3	Treppen	R9		
28.4	Toiletten, Waschräume	R10		
28.5	Lehrküchen in Schulen (siehe auch Nr. 9)	R10		
28.6	Küchen in Kindertageseinrichtungen (siehe auch Nr. 9)	R10		
28.7	Maschinenräume für Holzbearbeitung	R10		
28.8	Fachräume für Werken	R10		
28.9	Pausenhöfe	R11 (oder R10 V4)		
29	Geldinstitute			
29.1	Schalträume	R9		
30	Betriebliche Verkehrswege in Außenbereichen			
30.1	Gehwege	R11 (oder R10 V4)		
30.2	Laderampen			
30.2.1	überdacht	R11 (oder R10 V4)		
30.2.2	nicht überdacht	R12 (oder R11 V4)		
30.3	Schrägrampen (z. B. für Rollstühle, Ladebrücken)	R12 (oder R11 V4)		
30.4	Betankungsbereiche			
30.4.1	überdacht	R11		
30.4.2	nicht überdacht	R12		
31	Parkbereiche			
31.1	Garagen, Hoch- und Tiefgaragen ohne Witterungseinfluss*****)	R10		
31.2	Garagen, Hoch- und Tiefgaragen mit Witterungseinfluss	R11 (oder R10 V4)		
31.3	Parkflächen im Freien	R11 (oder R10 V4)		

1.2. Barfußbereich

Zuständig: Deutsche Gesetzliche Unfallversicherung, Mittelstraße 51, 10117 Berlin-Mitte, Telefon: +49-30-28876-3800, Fax: -3808, www.dguv.de, info@dguv.de, www.unfallkassen.de.

Böden in nassbelasteten Barfußbereichen, z. B. in Bädern, Krankenhäusern sowie Umkleide-, Wasch- und Duschräumen von Sport- und Arbeitsstätten.

Prüfnorm: DIN 51097.

Merkblatt: DGUV-Information 207-006 „Bodenbeläge für nassbelastete Barfußbereiche“. (bisherige GUV-I 8527)

Prüfverfahren: Schiefe Ebene, Begehung barfuß, Gleitmedium Netzmittellösung.

Die Oberflächen sind eben, mikrorauh oder mäßig profiliert.

Non-Slip-Glasuren mit ihren mikrorauen Oberflächen haben sich hervorragend bewährt.

Den Bewertungsgruppen sind die jeweiligen Bereiche zugeordnet.

Die Deutsche Gesetzliche Unfallversicherung und Agrob Buchtal geben Auskunft.

Bewertungsgruppe A

- Barfußgänge und Sanitärbereiche (weitgehend trocken)
- Einzel- und Sammelumkleideräume
- Beckenböden in Nichtschwimmerbereichen, wenn im gesamten Bereich die Wassertiefe mehr als 80 cm beträgt
- Sauna-, Ruhebereiche (weitgehend trocken)

Bewertungsgruppe B



- Barfußgänge und Sanitärbereiche, soweit sie nicht A zugeordnet sind
- Duschräume und Duschbereiche
- Dampfbäder
- Bereich von Desinfektionssprühanlagen
- Beckenumgänge
- Beckenböden in Nichtschwimmerbereichen, wenn in Teilbereichen die Wassertiefe weniger als 80 cm beträgt
- Beckenböden in Nichtschwimmerbereichen von Wellenbecken
- Hubböden
- Planschbecken
- Leitern und Treppen außerhalb des Beckenbereiches, soweit sie nicht C zugeordnet sind
- begehbare Oberflächen von Sprungplattformen und Sprungbrettanlagen, soweit sie nicht C zugeordnet sind
- Sauna- und Ruhebereiche, soweit sie nicht A zugeordnet sind

Bewertungsgruppe C

- Ins Wasser führende Leitern und Treppen
- Aufgänge zu Sprunganlagen und Wasserrutschen
- Oberflächen von Sprungplattformen und Sprungbrettern in der Länge, die für den Springer reserviert ist (Die rutschfeste Oberfläche der Sprungplattformen und Sprungbretter muss um die Vorderkante herumgeführt werden, wo die Hände und Zehen der Benutzer greifen)
- Durchschreitebecken
- Geneigte Beckenrandausbildung
- Kneippbecken, Tretbecken
- Rampen im Beckenumgangsbereich mit Neigung > 6%
- Startblöcke

Begehbare Sitzflächen, wie z. B. Tribünen und Podeste in Beckennähe, in die Nässe verschleppt werden kann, sind wie Bodenbelagsflächen zu behandeln. Werden Barfußbereiche planmäßig auch mit Schuhwerk begangen, sind zusätzlich die Anforderungen nach der ASR A1.5/1,2 zu beachten.

Test auf „Schiefer Ebene“

Bewertungs- Gruppen	Neigungswinkel	Barfußbereich
A	$\geq 12^\circ$	
B	$\geq 18^\circ$	
C	$\geq 24^\circ$	

Die angegebenen Neigungswinkel dienen ausschließlich zur Zuordnung der Bewertungsgruppen und sind nicht mit den Neigungswinkeln von Schrägen/Rampen gleichzusetzen.

1.3. Gleitreibmessung

Zuständig: Deutsche Gesetzliche Unfallversicherung, Mittelstraße 51, 10117 Berlin-Mitte, Telefon:

+49-30-28876-3800, Fax: -3808,

www.dguv.de, info@dguv.de, www.unfallkassen.de.

Prüfnorm: DIN 51131

Merkblatt: DGUV-Information 208-041 „Bewertung der Rutschgefahr unter Betriebsbedingungen“ (bisherige GUV-I 8687)

Diese Prüfung ist keine Baumusterprüfung und kann somit weder zur Auswahl von Bodenbelägen im Planungsstadium noch zu einer Eingruppierung in eine Bewertungsstufe der Rutschhemmung herangezogen werden. Das Verfahren kann z. B. zur Beurteilung des Erfolgs von Reinigungsmaßnahmen oder bei geplanten Nutzungsänderungen angewendet werden.

Für die Auswahl eines Bodenbelags sind ausschließlich DGUV-Regel 108-003 (bisherige BGR 181) bzw. DGUV-Information 207-006 (bisherige GUV-I 8527) anzuwenden!

1.4. Privatbereich

Hinsichtlich der Trittsicherheit unterliegen keramische Bodenbelagsflächen im Privatbereich keinen geregelten Vorgaben. Unabhängig davon, empfiehlt es sich, je nach persönlichem Sicherheitsbedürfnis, trittsichere Fliesen zu wählen.

Color Shade Variation

„Color shade variation“ beschreibt die farbliche Änderung zwischen den Fliesen einer Farbstellung, d.h. den Abtönungsgrad. Die Einstufung unserer Produkte erfolgt in 4 Abtönungskoeffizienten:

V1 = Geringe Variation / geringes Farbspiel
 V2 = Mittlere Variation / mittleres Farbspiel
 V3 = Hohe Variation / hohes Farbspiel
 V4 = Starke Variation / starkes Farbspiel

Rückseitig thermoplastische Mosaik-Verklebung: Auch bei Nässe dauerhaft sicher

Die thermoplastische Verklebung von Mosaiken der Marken Agrob Buchtal und Jasba ist auch für den Dauernass- und Unterwasserbereich bestens geeignet. Untersuchungen durch unabhängige Institute haben bestätigt, dass es unter üblichen hygienischen Bedingungen zu keinem mikrobiologischen Befall am Glasfasernetz kommt. Das Verbundverhalten nach Trocken- und Nasslagerung liegt oberhalb der Normwerte. Damit empfiehlt sich die rückseitige thermoplastische Verklebung nicht nur für Trockenbereiche, sondern auch für Unterwasserbereiche (Schwimmbecken und Whirlpools)

sowie für dauernassbelastete Bereiche wie Duschen und Beckenumgänge. Außerdem ist die rückseitige Verklebung verlegefreundlich und sorgt für deutliche Zeitersparnis gegenüber der bisher notwendigen vorderseitigen Folie. So verhindert das rückseitige Glasfasernetz weitgehend das Eindringen von Fliesenkleber in die Fugen. Das zeitaufwändige Entfernen der Folie und etwaiger Rückstände auf der Fliesenoberfläche entfällt. Die Auskleidung von Säulen und Rundungen wird entscheidend vereinfacht.



Deutsche Steinzeug Cremer & Breuer AG - Postfach 2140 - 53113 Bonn

Telefon	Telefax	E-Mail	Datum
0228/391-0	0228/391-30	info@deutsche-steinzeug.de	17.11.2014

Eignung der rückseitigen thermoplastischen Mosaikverklebung für den Einsatz im Dauernass- und Unterwasserbereich

Sehr geehrte Damen und Herren,

unsere thermoplastische Mosaikverklebung wurde von externen Instituten in Bezug auf mikrobiologische Eignung und die Haftzugfestigkeit für den Einsatz im Dauernass- und Unterwasserbereich geprüft.

Die Ergebnisse zeigen einerseits, dass es unter üblichen hygienischen Bedingungen zu keinem mikrobiologischen Befall am Glasfasernetz kommt. Zudem liegt das Verbundverhalten nach Trocken- und Nasslagerung mit Werten $>0,5N/mm^2$ oberhalb der nach DIN EN 12004 geforderten Werte.

Thermoplastisch verklebtes Mosaik der Marken AGROB BUCHTAL und Jasba sind somit bestens für den Einsatz in Bereichen wie Schwimmbecken, Beckenumgängen, Whirlpools oder Duschen geeignet.



Dieter Schöler
Vorstandsvorsitzender
Deutsche Steinzeug Cremer & Breuer AG



Ing. Daniel Schreiner
Leitung Zentralbereich Produktmanagement & Design
Deutsche Steinzeug Cremer & Breuer AG

Deutsche Steinzeug Cremer & Breuer AG

Servicestelle - 53347 Alfter-Wittreschlick - Telefon +49 (0) 228/391-0 - Telefax +49 (0) 228/391-30 (10 00)
 E-Mail: info@deutsche-steinzeug.de - www.deutsche-steinzeug.de

Vorstand: Dieter Schöler (Vorstandsvorsitzender), Michael Wester - Aufsichtsratsvorsitzender: Wilfried Delfker
 Handelsregister: Amtsgericht Bonn, HRB 20245 - Sitz der Gesellschaft: Alfter

Anschriftenliste

Bundesanstalt für Arbeitsschutz und Arbeitsmedizin (BAuA)

Friedrich-Henkel-Weg 1-25, 44149 Dortmund
 Telefon: +49-231-9071-0, Fax: -2454,
 www.baua.de, poststelle@baua.bund.de

DGUV-Regelwerke (BG/GUV)

Deutsche Gesetzliche Unfallversicherung

Mittelstraße 51, 10117 Berlin-Mitte,
 Telefon: +49-30-28876-3800, Fax: -3808,
 www.dguv.de, info@dguv.de

DIN/EN/ISO Normenblätter

Deutsches Institut für Normung e. V., 10772 Berlin
 Telefon: +49-30-2601-0, Fax: -60,
 www.din.de, peter.anthony@din.de,
 Bezugsquelle:
 Beuth Verlag GmbH, Burggrafenstraße 6,
 10787 Berlin, Telefon: +49-30-2601-2201-0, Fax: -1260,
 www.beuth.de, info@beuth.de

KOK-Richtlinien für den Bäderbau

RK-Liste geprüfter Reinigungsmittel

DGfDB-Regelwerke

Deutsche Gesellschaft für das Badewesen e. V.,
 45130 Essen
 Telefon: +49-201-87969-0, Fax: -20,
 www.baederportal.com, info@baederportal.com
 Bezugsquelle: Direktbezug beim Herausgeber

Bundesverband Keramische Fliesen e. V.

Luisenstraße 44, 10177 Berlin
 Telefon: 030/27 59 59 74-0, Fax: -99
 www.fliesenverband.de, info@fliesenverband.de

ZDB-Merkblätter

Fachverband Fliesen und Naturstein im Zentralverband des Deutschen Baugewerbes

Kronenstr. 55-58, 10117 Berlin-Mitte,
 Telefon: +49-30-20314-0, Fax: -419,
 www.fachverbandfliesen.de, info@fachverband-fliesen.de
 Bezugsquelle:
 Verlagsgesellschaft Rudolf Müller GmbH & CoKG,
 Stolberger Straße 84, 50933 Köln
 Postfach: 410949, 50869 Köln
 Telefon: +49-221-5497-112, Fax: -6112
 www.baufachmedien.de, service@rudolf-mueller.de

Güteprüfungen

Güteprüfungen erfolgen durch:

- Eigenprüfung der produzierenden Werke mit strenger Sortierung
- Kontroll- und Sonderprüfungen der Deutsche Steinzeug Labore
- Einzel- und Serienprüfungen durch externe Materialprüfanstalten im In- und Ausland

Zeugnisse

Unsere Produkte werden in anerkannten Materialprüfungsämtern hinsichtlich der Eigenschaften und der Qualität ständig geprüft. Entsprechende Prüfungszeugnisse liegen vor.



CERTIFIED BY
SCS Global Services



Duschtassensystem Plural non-slip/Plural unglasiert/Basis 3

Das Duschtassensystem besteht aus Formstückfliesen zur Erstellung einer in den Fliesenbelag integrierten Duschtasse.

Das Duschtassensystem ist mit Gebrauchsmusterschutz versehen. Es entspricht den Vorgaben der DIN 18040 Barrierefreies Bauen und DIN 18025 Barrierefreies Wohnen.

Die Schwallkante von 10 mm erlaubt eine uneingeschränkte Inanspruchnahme verschiedener Wohnungsbauförderungsbestimmungen.

Das Modulmaß von 100 mm inkl. einer 3 mm-Fuge garantiert hygienisch einwandfreie Fliesenbeläge mit schmaler Fugenbreite und maßhaltigen Fliesen.

Wie alle Trittsicherheitsoberflächen von Plural non-slip/Plural unglasiert, der Serie Basis 3 sind sowohl die glasierten als auch die keramisch vergüteten, unglasierten Fliesenoberflächen sehr leicht zu reinigen.

Das Duschtassensystem ist prädestiniert für Nasszellen in Krankenhäusern, Sanatorien, Rehasentren, Alten- und Pflegeheimen, aber auch für gewerbliche Reihenduschen, Schwimmbad-, Sauna- und Sportanlagen, Hotel- und Privatbäder.

1. Die Duschtasse ist beliebig in den Fliesenbelag integrierbar und ermöglicht modular im Fugenraster das erforderliche Gefälle.

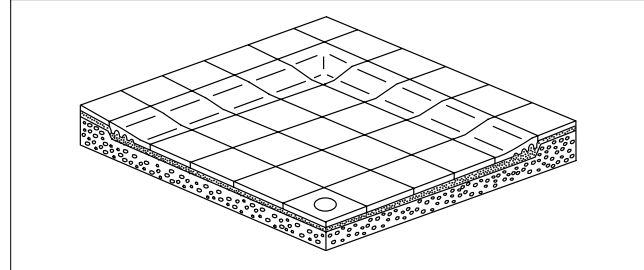

2. In Kombination mit dem flach liegenden Kehlsockel ist ein gerundeter Übergang vom Boden- zum Wandbelag möglich.

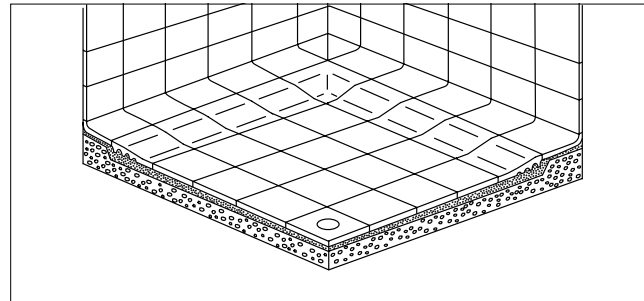

Plural non-slip, Plural unglasiert

Basis 3 Softcorn

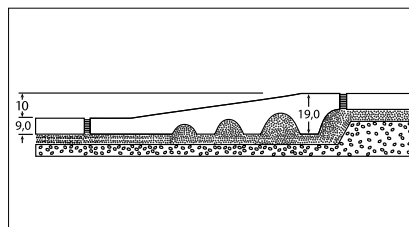
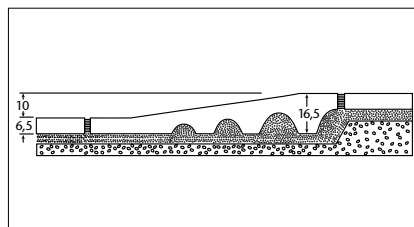
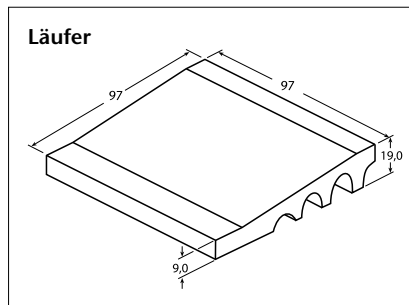
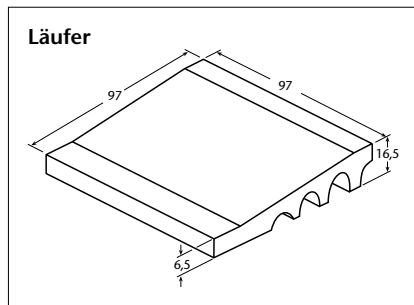
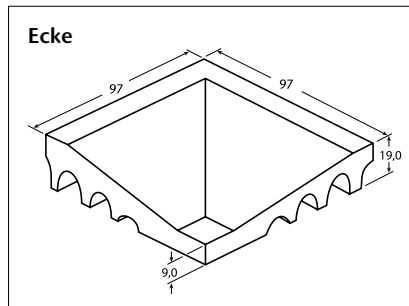
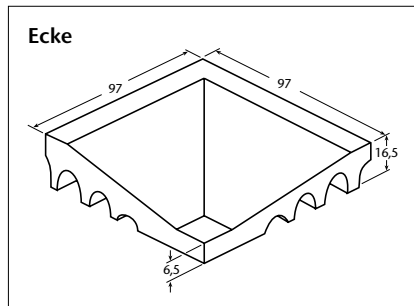

Alle Angaben sowie Zitate aus Produkt- und Prüfnormen sind als unverbindliche Hinweise zu betrachten. Es gelten die jeweils aktuellsten Fassungen.

Duschtassensystem der Serien Chroma / Chroma unglasiert – Quantum

Dieses Duschtassensystem besteht aus nur zwei Komponenten: Dem Läufer und der dazu gehörigen einteiligen Ecke.

Eine Besonderheit ist die spezielle Form der Absenkung, die eine Höhendifferenz von 10 mm aufweist. Der so gestaltete Duschtassenrand ist leicht zu begehen bzw. problemlos mit dem Rollstuhl zu befahren. Die einschlägigen Forderungen (DIN 18040 bzw. 18025) in Bezug auf das barrierefreie, Senioren- und behindertengerechte Bauen werden somit wirkungsvoll unterstützt.

Durch die „eingebaute Schräge“ muss der Duschtassenrand nicht mehr mühsam örtlich ausgebildet werden, und in Verbindung mit der verlegefreundlichen Unterseite ist die Verarbeitung daher denkbar einfach:

Das Duschtassensystem wird perfekt ergänzt durch die Serien Chroma / Chroma unglasiert – Quantum.

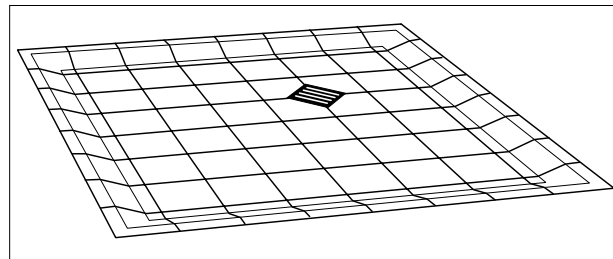

Das Duschtassensystem basiert auf einem Rastermaß von 12,5 x 12,5 cm. Dies erlaubt eine sehr variable, von Standardabmessungen unabhängige Dimensionierung der Duschtasse und eine harmonische Integration in die Duschanlage bzw. Nasszelle.

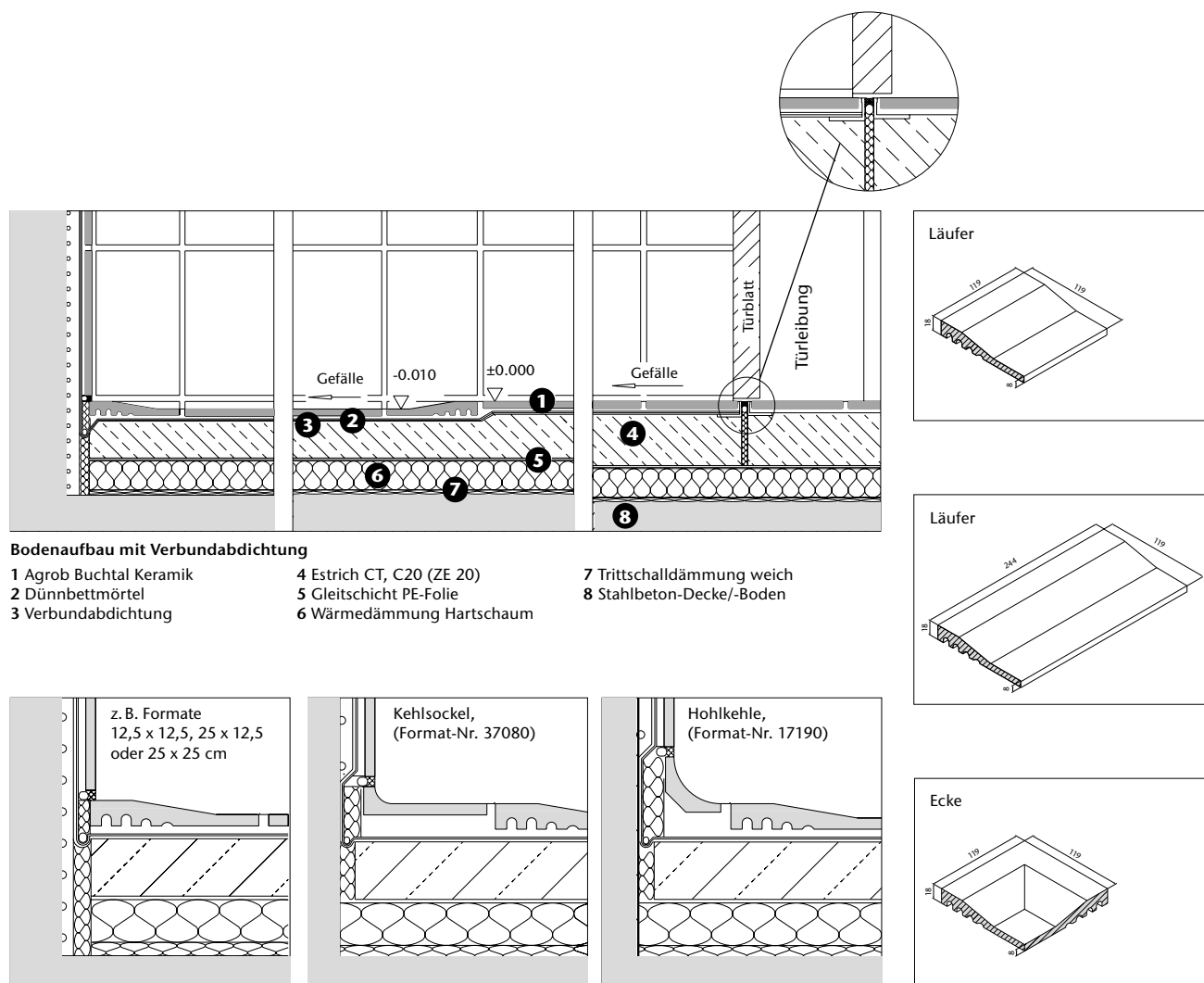

Wandanschlussvarianten

Die Duschtassensysteme von Agrob Buchtal werden auf einem durchgehenden Zementestrich verlegt und haben somit keine wartungsaufwändige Bewegungsfuge zwischen Duschtasse und anschließenden Flächen.

Alle Angaben sowie Zitate aus Produkt- und Prüfnormen sind als unverbindliche Hinweise zu betrachten. Es gelten die jeweils aktuellsten Fassungen.

Kehlsockel 10 x 10, 10 x 20, 10 x 30 und 10 x 60 cm (Details)

Kehlsockel 10 x 10 cm

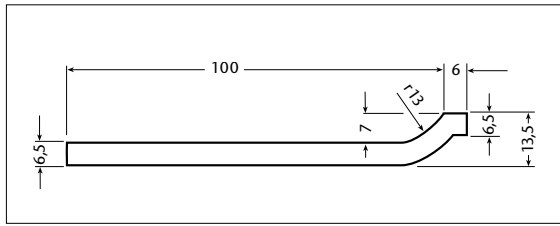

Area Pro, eben, 10 x 10, unglasiert
Plural/Plural non-slip, eben und trittsicher, 10 x 10 cm
Basis 2, eben, 10 x 10 cm, glasiert
Basis 3, eben, 10 x 10 cm, unglasiert
Plural unglasiert, eben, 10 x 10 cm

Kehlsockel 10 x 15, 10 x 20, 10 x 30 cm und 10 x 60 cm

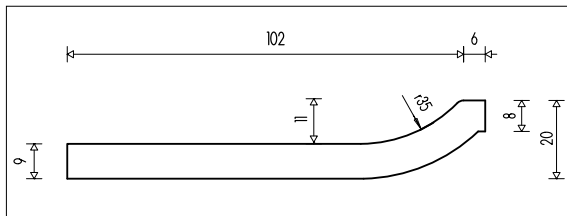

Passend zu:

Emotion GRIP, eben oder Softcorn
 10 x 20, 10 x 30 cm, unglasiert

Basis 3,
 eben, 10 x 15, 10 x 20 cm, unglasiert

Area Pro,
 eben, 10 x 20 cm, 10 x 30 cm und 10 x 60 cm, unglasiert

Innenecke

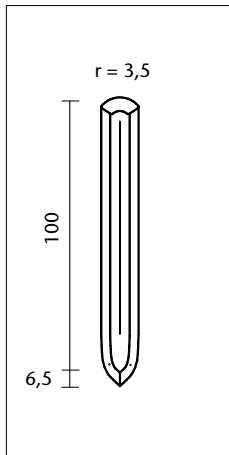

Außenecke

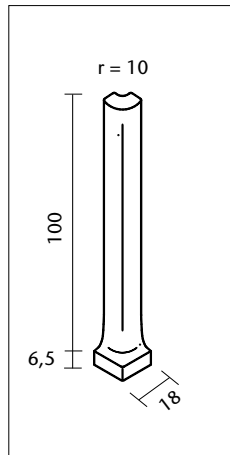

Passend zu Kehlsockel:

Plural non-slip,
 10 x 10 cm, glasiert

Innenecke

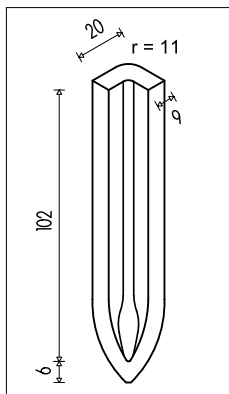

Passend zu Kehlsockel:

Area Pro,
 10 x 10, 10 x 20, 10 x 30,
 10 x 60 cm, unglasiert

Emotion GRIP,
 10 x 10, 10 x 20
 und 10 x 30 cm, unglasiert

Basis 3,
 10 x 20 cm, unglasiert

Außenecke

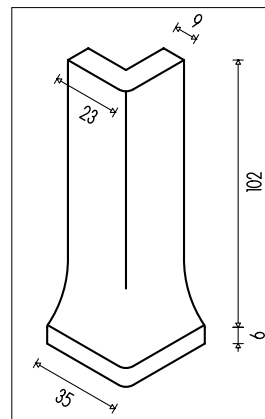

Passend zu Kehlsockel:

Area Pro,
 10 x 10, 10 x 20, 10 x 30,
 10 x 60 cm, unglasiert

Emotion GRIP,
 10 x 20 und 10 x 30 cm, unglasiert

Basis 3,
 10 x 20 cm, unglasiert

Kehlsockel, geschnitten/verklebt 15 x 60 cm bzw. Innenecken 15 x 15 cm

Details: Können aus beliebigen Fliesen/Platten gefertigt werden. Optik und Haptik analog der umgebenden Fläche, d.h. sowohl Struktur als auch Farbgleichheit werden gewährleistet. Mindestbestellmenge Sockel: 50 Stück; Ecke: 50 Stück

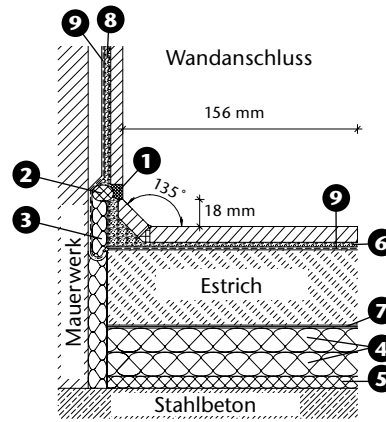
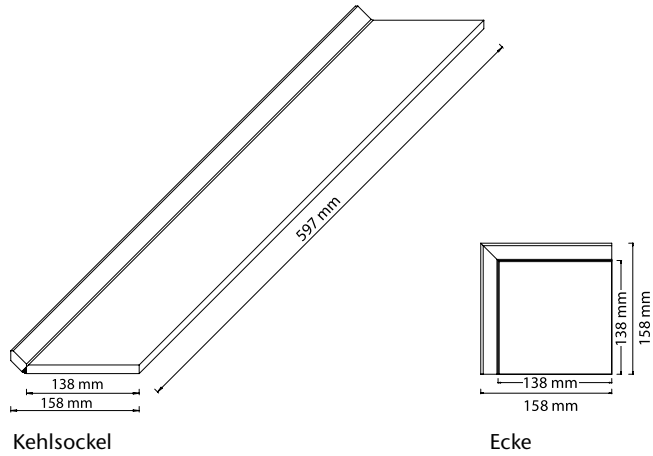

Maßstab 1:5

- 1 UW Silikon
- 2 Geschlossenzellige PE-Schaumstoffrundschnur bzw. Trennfolie
- 3 Wasserbeständiges, elastisches Füllmaterial
- 4 Wärmedämmung Hartschaum
- 5 Trittschalldämmung weich
- 6 Mörtel / Kleber
- 7 Gleitschicht PE-Folie
- 8 Dünnbettverlegung aus Zementputz
- 9 Abdichtung im Verbund

Treppenkanten / Treppenfliesen Area Pro

Treppenkante
75 x 600 mm mit 5 Rillen

75x600 mit 5 Rillen

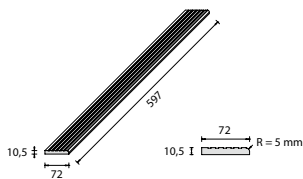

Treppenkante mit Schräge
75 x 135 mm mit 5 Rillen

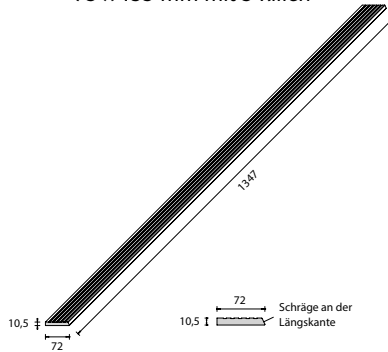

Treppenkante
75 x 1200 mm mit 5 Rillen

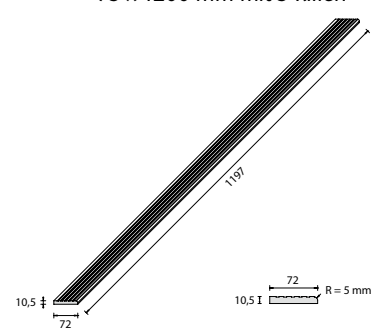

Treppenfliese
600 x 1200 mm mit 5 Rillen

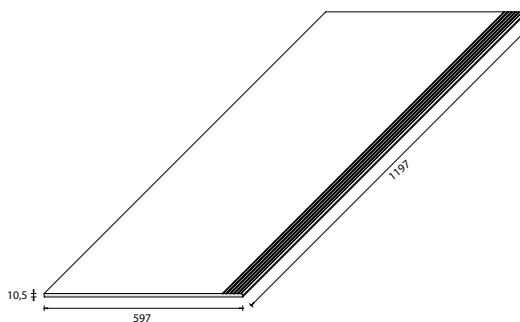

Treppenfliese mit Schräge
310 x 1350 mm mit 5 Rillen

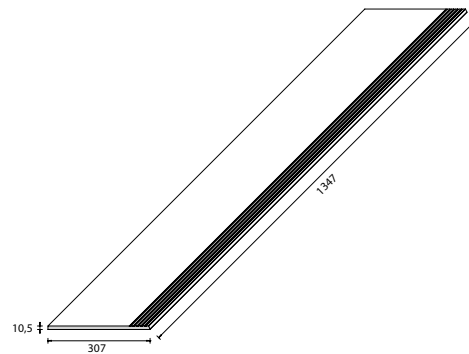

1. Bauprodukteverordnung (BauPVO)

Die BauPVO unterscheidet sich insbesondere durch die Leistungserklärung, die CE-Kennzeichnung und die Bewertung und Überprüfung der Leistungsbeständigkeit von der bisherigen Bauprodukterichtlinie (BPR).

Bauprodukte, die nach dem 01. Juli 2013 in Verkehr gebracht werden, müssen der BauPVO entsprechen. Unter „Inverkehrbringen“ ist die erstmalige Verfügbarkeitsmachung eines Bauprodukts auf dem europäischen Markt durch den Hersteller zu verstehen. Wir weisen darauf hin, dass der Begriff der „Bereitstellung“ davon abgegrenzt ist, welcher die Weitergabe eines in Verkehr gebrachten Bauprodukts in der Lieferkette bezeichnet z. B. vom Fliesenfachhandel an den Endkunden.

Wesentliche Merkmale eines Bauprodukts, hier keramische Fliesen und Platten, sind im Anhang ZA der harmonisierten Norm DIN EN 14411 festgelegt.

2. CE-Kennzeichnung

Der Hersteller dokumentiert damit, dass er die Verantwortung für die Übereinstimmung des Bauprodukts mit der in der Leistungserklärung angegebenen Leistung sowie die Einhaltung aller einschlägigen europäischen Rechtsvorschriften übernimmt.

Weiterhin ist er dafür verantwortlich, dass das CE-Kennzeichen auf dem Bauprodukt selbst, einem Etikett oder auf der Verpackung angebracht ist. Das CE-Kennzeichen ist das alleinige Übereinstimmungskennzeichen für alle wesentlichen Merkmale eines Bauprodukts. Lediglich für Aspekte, die in unserem Fall nicht von der DIN EN 14411 geregelt werden, dürfen zusätzliche Zeichen eingesetzt werden.

3. Leistungserklärung

Seit 01. Juli 2013 ist jeder Hersteller verpflichtet für jedes seiner Bauprodukte eine Leistungserklärung zu erstellen. Damit übernimmt er die Verantwortung für die Übereinstimmung des Bauprodukts mit den erklärten Leistungen. Die Leistungserklärung löst die bisherige Konformitätserklärung ab.

Grundlage für die Leistungserklärung bildet die technische Dokumentation des Herstellers. Hierzu zählen u. a. die Ergebnisse der werkseigenen Produktionskontrollen wie z. B. Erstprüfungen.

Die Leistungserklärung ist mit einer vom Hersteller frei wählbaren Referenznummer zu versehen, auf die im Rahmen der CE-Kennzeichnung Bezug genommen wird und damit eine eindeutige Identifikation des Bauprodukts ermöglicht.

Die Leistungserklärung kann in gedruckter oder in elektronischer Form (z. B. Mail, CD oder USB Stick) bereitgestellt werden.

Weiterhin können die Leistungserklärungen für die Bauprodukte der Agrob Buchtal GmbH unter www.agrob-buchtal.de/leistungserklaerung eingesehen werden. Scannen Sie alternativ diesen QR-Code:



ARCHITEKTURKERAMIK DEUTSCHLAND

Verkaufsgebiet	PLZ-Gebiet	Gebietsleitung	E-Mail	mobil
0020	17 (ohne 17192 bis 17291, 17326, 17335 bis 17337), 18, 19 (ohne 19309, 19322, 19336, 19348, 19357), 20, 21 (ohne 21244 bis 21272, 21614 bis 21799), 22, 23, 24, 25	Stephan Rüttel	Stephan.Ruettel@deutsche-steinzeug.de	0171/4773605
0021	21244 bis 21272, 21614 bis 21799, 26, 27, 28, 29 (ohne 29410 bis 29416), 31582, 31592, 31595, 31600 bis 31638	Jochen Prinz	Jochen.Prinz@deutsche-steinzeug.de	0171/5669993
0022	45600 bis 45799, 46325, 46348, 46359, 46395 bis 46399, 46414, 46419, 46459, 46487, 46499, 48 (ohne 48155 und 48529), 49, 59330 bis 59399	Alfons Seggewiss	Alfons.Seggewiss@deutsche-steinzeug.de	0160/5898429
0023	06, 19309 bis 19357, 29410 bis 29416, 38835 bis 38899, 39, 99706 bis 99768	Thomas Bischoff	thomas.bischoff@deutsche-steinzeug.de	0151/11012473
0024	30, 31 (ohne 31582, 31592, 31595, 31600 bis 31638), 37154 bis 37199, 37412 bis 37431, 37441 bis 37649, 38 (ohne 38835 bis 38899)	N.N.	Kontaktieren Sie uns gerne über die Website: https://agrob-buchthal.de/de/architekt-planer/support/kontakt	
0025	32, 33, 44 (ohne 44629), 57 (ohne 57520, 57567, 57583, 57627, 57629, 57642), 58, 59 (ohne 59330 bis 59399)	Janina Schwarz	Janina.Schwarz@deutsche-steinzeug.de	0171/5669988
0026	34, 35, 36, 37 (ohne 37154 bis 37199, 37412 bis 37431, 37441 bis 37649), 60, 61, 63, 98527 bis 98639, 99610 bis 99638, 99817 bis 99848, 99947 bis 99998	Heiner Butz	Heiner.Butz@deutsche-steinzeug.de	0170/8516489
0027	40, 41, 42, 45 (ohne 45600 bis 45799), 46 (ohne 46325, 46348, 46359, 46395 bis 46399, 46414, 46419, 46459, 46487, 46499), 47, 50, 51, 52, 53	Harald Baumann	Harald.Baumann@deutsche-steinzeug.de	0171/9708365
0028	54 (ohne 54290 bis 54296), 55, 56, 57520, 57567, 57583, 57627, 57629, 57642, 64, 65, 66, 67, 68, 69	Patrick Büchner	Patrick.Buechner@deutsche-steinzeug.de	0171/7619457
0029	10, 12, 13, 14, 15, 16, 17192 bis 17291, 17326, 17335 bis 17337	Thomas Bischoff	thomas.bischoff@deutsche-steinzeug.de	0170/5618977
0030	72250 bis 72297, 74 (ohne 74321 bis 74399), 75, 76, 77, 78, 79	Thomas Hüttner	Thomas.Huettner@deutsche-steinzeug.de	0151/12013231
0031	70, 71, 72 (ohne 72250 bis 72297), 73, 74321 bis 74399, 88, 89	Jan Rebmann	Jan.Rebmann@deutsche-steinzeug.de	0171/7600631
0032	01, 02, 03, 04, 07, 08, 09, 98646 bis 98749, 99084 bis 99518, 99867 bis 99898	Jonas Wünsche	Jonas.Wuensche@deutsche-steinzeug.de	0171/2254226
0033	90, 91, 92, 95, 96, 97	Markus Dörfler	Markus.Doerfler@deutsche-steinzeug.de	0170/9107373
0035	83000 bis 83599, 84, 93, 94	Martin Schart	Martin.Schart@deutsche-steinzeug.de	0171/7648319
0036	80, 81, 82, 83600 bis 83799, 85, 86, 87	Tilo Lankes	Tilo.Lankes@deutsche-steinzeug.de	0175/7266899

WOHNKERAMIK DEUTSCHLAND

Verkaufsgebiet	PLZ-Gebiet	Gebietsleitung	E-Mail	mobil
0020	17 (ohne 17192 bis 17291, 17326, 17335 bis 17337), 18, 19 (ohne 19309, 19322, 19336, 19348, 19357), 20, 21 (ohne 21244 bis 21272, 21614 bis 21799), 22, 23, 24, 25	Steffen Jantzen	Steffen.Jantzen@deutsche-steinzeug.de	0171/9967208
0021	21244 bis 21272, 21614 bis 21799, 26, 27, 28, 29 (ohne 29410 bis 29416), 31582, 31592, 31595, 31600 bis 31638	Michael Weber	Michael.Weber@deutsche-steinzeug.de	0170/9241872
0022	45600 bis 45799, 46325, 46348, 46359, 46395 bis 46399, 46414, 46419, 46459, 46487, 46499, 48 (ohne 48155 und 48529), 49, 59330 bis 59399	Dominik Gellenbeck	Dominik.Gellenbeck@deutsche-steinzeug.de	0160/96310615
0023	06, 19309 bis 19357, 29410 bis 29416, 38835 bis 38899, 39, 99706 bis 99768	Thomas Bischoff	Thomas.Bischoff@deutsche-steinzeug.de	0151/11012473
0024	30, 31 (ohne 31582, 31592, 31595, 31600 bis 31638), 37154 bis 37199, 37412 bis 37431, 37441 bis 37649, 38 (ohne 38835 bis 38899)	Michael Weber	Michael.Weber@deutsche-steinzeug.de	0170/9241872
0025	32, 33, 44 (ohne 44629), 57 (ohne 57520, 57567, 57583, 57627, 57629, 57642), 58, 59 (ohne 59330 bis 59399)	Holger Rohse	Holger.Rohse@deutsche-steinzeug.de	0170/6322876
0026	34, 35, 36, 37 (ohne 37154 bis 37199, 37412 bis 37431, 37441 bis 37649), 60, 61, 63, 98527 bis 98639, 99610 bis 99638, 99817 bis 99848, 99947 bis 99998	Andreas Strickrodt	Andreas.Strickrodt@deutsche-steinzeug.de	0171/5402801
0027	40, 41, 42, 45 (ohne 45600 bis 45799), 46 (ohne 46325, 46348, 46359, 46395 bis 46399, 46414, 46419, 46459, 46487, 46499), 47, 50, 51, 52, 53	Michael Andries	Michael.Andries@deutsche-steinzeug.de	0171/8610267
0028	54 (ohne 54290 bis 54296), 55, 56, 57520, 57567, 57583, 57627, 57629, 57642, 64, 65, 66, 67, 68, 69	Bernhard Staffeldt	Bernhard.Staffeldt@deutsche-steinzeug.de	0171/5669991
0029	10, 12, 13, 14, 15, 16, 17192 to 17291, 17326, 17335 to 17337	Thomas Bischoff	Thomas.Bischoff@deutsche-steinzeug.de	0151/11012473
0030	72250 bis 72297, 74 (ohne 74321 bis 74399), 75, 76, 77, 78, 79	Michael Stoll	Michael.Stoll@deutsche-steinzeug.de	0151/14823489
0031	70, 71, 72 (ohne 72250 bis 72297), 73, 74321 bis 74399, 88, 89	Michael Stoll	Michael.Stoll@deutsche-steinzeug.de	0151/14823489
0032	01, 02, 03, 04, 07, 08, 09, 98646 bis 98749, 99084 bis 99518, 99867 bis 99898	Jonas Wünsche	Jonas.Wuensche@deutsche-steinzeug.de	0171/2254226
0033	90, 91, 92, 95, 96, 97	Frank Lohre	Frank.Lohre@deutsche-steinzeug.de	0171/5661429
0035	83000 bis 83599, 84, 93, 94	Florian Nößner	Florian.Noessner@deutsche-steinzeug.de	0170/5629482
0036	80, 81, 82, 83600 bis 83799, 85, 86, 87	Florian Nößner	Florian.Noessner@deutsche-steinzeug.de	0170/5629482



ÖSTERREICH

Österreich, Oberösterreich, Steiermark	Robert Wölfler	Robert.Woelfler@deutsche-steinzeug.de	+43 664/1342659
Wien, Niederösterreich, Burgenland	Silvia Lederer	Silvia.Lederer@deutsche-steinzeug.de	+43 664/3076686
Tirol, Vorarlberg, Salzburg, Kärnten	Erwin Bauer	Erwin.Bauer@deutsche-steinzeug.de	+43 664/1153558

SCHWEIZ

Deutsche Steinzeug Schweiz AG,
Oberstmühle 3, 6370 Stans/NW
info@deutsche-steinzeug.ch
+4141/6325060



Einfach zu finden

Die einzelnen Serien werden jeweils in folgender Form dargestellt:

- Farbübersicht
- Kurzbeschreibung
- Produktdaten
- Leuchtdichtekontrast

- 1 **Serienname**; daneben Materialart (siehe Seite 463) und maßgebliche Produktnorm (siehe Seite 462)
- 2 **Ordnungsschema der Formate** von links nach rechts: Flächenformate von klein nach groß bei Spalt- und Steinzeugplatten rechteckige, dann quadratische Formate von klein nach groß Formteile / Formstücke
- 3 **Besonderheiten** des Formats
- 4 **Formatnummer** (nur bei Spalt- und Steinzeugplatten)
- 5 **Nennmaß** = Herstellmaß + empfohlene Fugenbreite in Zentimeter und Inch
Herstellmaß = reines Materialmaß ohne Fuge
- 6 **Oberflächenbeschaffenheit** (nur bei Steingut-, Steinzeug- und Feinsteinzeugfliesen)
- 7 Logistische **Produktdaten**
- 8 **Produktnorm**
- 9 **Trittsicherheitseinstufung**: Barfußbereich/öffentlich-gewerblicher Bereich (siehe Seiten 469 ff)
- 10 **Belastungsgruppe 1 – 5**; Orientierungshilfe für den Industrie- und Gewerbebereich (siehe Seite 469 ff)
- 11 **Artikelnummer**
- 12 **Abriebverhalten** bei glasiertem Material nach Beanspruchungsgruppen 1-5; (siehe Seite 466).
- 13 **Farbbezeichnung** und/oder Farbnummer
- 14 **Preisgruppe** (in Klammern Berechnungseinheit)

256

PLURAL NON-SLIP 1

Steinzeug

2 **Wand-/Bodenfliesen**

2,5 x 2,5 cm

5 x 5 cm

10 x 10 cm



3 **Mosaik, rückseitig thermoplastisch verklebt**
Bogen: 297 x 297 mm

Mosaik, rückseitig thermoplastisch verklebt
Bogen: 297 x 297 mm

Mosaik, rückseitig thermoplastisch verklebt
Bogen: 297 x 297 mm

5 Nennmaß - cm/in	2,5 x 2,5 / 1 x 1	5 x 5 / 2 x 2	10 x 10 / 4 x 4
6 Herstellmaß	23 x 23 x 6,5 mm	47 x 47 x 6,5 mm	97 x 97 x 6,5 mm
6 Oberfläche	eben, trittsicher	eben, trittsicher	eben, trittsicher
6 m ² - Stück	11 Bögen	11 Bögen	11 Bögen
6 m ² - kg	12,100	12,331	13,101
7 Paket - Stück	11 Bögen	11 Bögen	11 Bögen
7 Paket - m ²	1,000	1,000	1,000
7 Paket - kg	12,100	12,331	13,101
7 Palette - m ²	40,000	64,000	64,000
7 Palette - kg	484,000	789,184	838,464
8 Produktnorm	Bib	Bib	Bib
8 Trittsicherheit	R10/B	R10/B	R10/B
10 Belastung	1 - 2	1 - 2	1 - 2
neutral 10 (aktivweiß)	4 902-2120H (Preisgr. A216 (m ²))	4 905-2120H (Preisgr. A169 (m ²))	4 910-2120H (Preisgr. A157 (m ²))
neutral 9 (weißgrau)	4 902-2119H* (Preisgr. A271 (m ²))	4 905-2119H* (Preisgr. A241 (m ²))	4 910-2119H (Preisgr. A184 (m ²))
neutral 8 (lichtgrau)	4 902-2118H (Preisgr. A216 (m ²))	4 905-2118H (Preisgr. A169 (m ²))	4 910-2118H (Preisgr. A157 (m ²))

Es werden folgende Symbole verwendet:

- Hytect-Oberfläche (Erklärung siehe Seiten 10 und 474)
- Protecta-Vergütung (Erklärung siehe Seite 474)
- Neuheiten
- Nicht mit Schuhen zu begehen
- Rektifiziert
- Konisch rektifiziert
- Auftragsfertigung ist nicht stornierbar!
Dies gilt für alle hiermit gekennzeichneten Artikel, insbesondere:
- Riegelformate
- Treppenfliesen
- kursiv gedruckte Artikelnummern
- Blindenleitsystem
- Frostbeständig
- R9** Trittsicher
- B** Trittsicher Barfußbereich
- Made in Germany
- Thermoplastische Verklebung
- in weiteren Farben lieferbar
- 6 mm Fliese

AGROB BUCHTAL GmbH
Buchtal 1, D-92521 Schwarzenfeld
Tel.: +49 (0) 94 35-391-0
Fax: +49 (0) 94 35-391-34 52

E-Mail: agrob-buchtal@deutsche-steinzeug.de
Internet: www.agrob-buchtal.de

01/2022, www.assenmacher.net



Der Herausgeber übernimmt keine Haftung für Druckfehler. Farbabweichungen zu den Originalprodukten können aus drucktechnischen Gründen auftreten.



Living

Ceramics for modern interiors

Lieferprogramm
Programme de Livraison
Programme of Delivery

2022

consumer
ceramics

DEUTSCHE STEINZEUG AGROB BUCHTAL Jasba

Project

Amano

Area Pro

NEW Ascona

Basic Stone

Basis 1/1+ | 2 | 3 | 4

Basis Pro,

Blindenleitsysteme

Systèmes de bande d'éveil · **Orientation aids for the blind**

Chroma: non-slip, unglasiert · non-émaillé · unglazed

Craft

NEW Craft Extended

District

Eladuct + Keraion ELA

Emotion

Emotion Grip

Ferrum

Fresh

Karl

Kauri

Keraion-OP-Spezialglasuren ·

Émaux spéciaux pour salles d'opération · **Keraion special glazed for operating theatres**

Loop

NEW Marble & More

Naturkeramik · Cèramique Naturelle · **Natural Ceramics**

New Market

Nova

Plural: non-slip, unglasiert · non-émaillé · unglazed

Plural Kids

Quarzit

Savona

Streetlife

Surf

Trias

Unique

Valley

Xeno



Die architekturkeramischen Serien finden Sie ab sofort im Lieferprogramm Project.

Vous trouverez les séries de la céramique d'architecture dans le programme de livraison « Projets » avec effet immédiat.

You will find the architectural ceramics series in the Projects programme of delivery as of now.

Pool + Spa

Chroma, Beckenkopfsysteme – Systemlösungen im Schwimmbadbau:

Finnland, Finnland II, Wiesbaden, Wiesbaden Therapiebecken, Bamberg, St. Moritz, Berlin, Zürich, Skimmer

Bäderformteile: Hohlkehlsystem, Sockelsystem, Radialleistensysteme, Rillenplatten, Spezialplatten

Schwimmbadzubehör – Abläufe und Abdeckroste

Keramische Rinnenabdeckung 2.0

Chroma, systèmes de tête de piscine – solutions de système dans la construction de piscines :

Finlande, Finlande II, Wiesbaden, piscine thérapeutique de Wiesbaden, Bamberg, St. Moritz, Berlin, Zurich, « Skimmer »

Pièces spéciales de piscines :

Système à gorges, système de plinthes, systèmes de profils arrondis, carreaux à rainures, carreaux spéciaux

Accessoires de piscine – grilles de recouvrement et écoulements

Recouvrement céramique de goulotte 2.0

Chroma, pool edge systems – system solutions in swimming pool construction:

Finland, Finland II, Wiesbaden, Wiesbaden therapy pools, Bamberg, St. Moritz, Berlin, Zürich, Skimmer

Swimming pool special pieces:











Skirtings, profiled edgings, grooved tiles, special tiles

Swimming pool accessories – outlets and cover gratings

Ceramic channel cover 2.0

Living

Einleitung · Introduction	4 – 15
Produktfinder · Recherche de produits · Product finder	16 – 19

Alcina 	20 – 29
NEW Aruba 	30 – 37
Basis 1	38 – 45
Cedra 	46 – 53
Como	54 – 57
Concrete	58 – 63
Evalia 	64 – 71
Focus Royal	72 – 77
NEW Jasba-CLARA	78 – 81
Jasba-PATTERN	82 – 89
Jasba-RONDA	90 – 93
Jasba-SENJA PURE	94 – 99
Jasba-VILLAGE	100 – 103
Jasba-NIVELLA	104 – 107
Kiano	108 – 115
La Casa 	116 – 121
Like	122 – 131
Lunar 	132 – 137
Mandalay 	138 – 143
Mando	144 – 149
Modern White	150 – 155
Oak	156 – 161
Pizarro 	162 – 165
Remix	166 – 175
Sierra	176 – 181
Sky	182 – 185
NEW Solid Rock	186 – 195
Soul	196 – 201
Stories	202 – 211
Timeless 	212 – 217
Trevi 	218 – 221
Urban Cotto	222 – 225
Walden 	226 – 229

Artikelnummernübersicht	230 – 232
Aperçu des numéros d'articles · Article overview	
Formatübersicht	233
Formats · Index according to models	
Vertriebskontakte	234 – 235
Sales contacts · Contacts commerciaux	
Technische Informationen	236
Informations techniques · Technical information	
Erläuterungen	237
Explications · Explanations	

Wir verstehen. Seit 1755.

Nous comprenons. Depuis 1755.
We understand. Since 1755.



Verlässlich

Wir kennen uns aus mit Fliesen. Seit 1755 arbeiten wir mit Ton und haben ein umfassendes Verständnis für unser Material und für die Herstellung von Steinzeug, Feinsteinzeug und Steingut von höchster Qualität. In unseren vier deutschen Produktionsstätten verfeinern wir ständig unsere Rezepte zum Mischen von Ton, Feldspat, Schamotte, Kaolin und Wasser. Als natürliches Material, das in sorgfältig überwachten Brennprozessen von plastisch nach fest übergeht, bietet Ton unendliche Möglichkeiten der Herstellung von keramischen Produkten, die dazu beitragen, Architektur dauerhaft, nachhaltig und schön zu machen.

Fiabilité

Nous nous y connaissons en matière de carreaux. Nous travaillons l'argile depuis 1755 et avons une connaissance approfondie de notre matériau et de la manière de produire du grès cérame, du grès cérame fin vitrifié et de la faïence de la plus haute qualité. Dans nos quatre sites de production allemands, nous affinons constamment nos recettes

pour mélanger l'argile, le feldspath, la chamotte, le kaolin et l'eau. Matériau naturel qui passe de l'état plastique à l'état solide grâce à des procédés de cuisson soigneusement contrôlés, l'argile offre des possibilités infinies pour créer des produits céramiques qui contribuent à rendre l'architecture permanente, durable et belle.

Dependable

We know tiles. Working with clay since 1755, we have a full-fledged understanding of our material, and how to make stoneware, porcelain stoneware, and earthenware of the highest quality. In our four German production facilities we continue to refine our recipes to mix clay, feldspar, fireclay, kaolin and water. Going from malleable to firm in carefully monitored firing processes, clay is a natural material with infinite possibilities to craft ceramic products which contribute to make architecture durable, sustainable, and beautiful.

Vielseitig

Unsere Produkte finden weit und breit Anwendung. Innen und Außen. Von Privatwohnungen bis hin zu Museen. Von Hotels bis zu Krankenhäusern. Von Restaurants bis zu Büros. Von Geschäften bis zu Schwimmbädern. Von Badezimmerböden bis zu Gebäudefassaden. Wir bieten Boden-, Wand- und Fassadenfliesen für jeden Verwendungszweck an. Und wir stellen alle Arten von Spezialelementen her, um nahezu jede spezifische Anforderung zu erfüllen, sei es ein Formteil für ein Schwimmbad oder ein integriertes Leitsystem für sehbehinderte Menschen. Unsere Fliesen finden sich überall, weltweit.

Diversité

Nos produits sont utilisés partout. À l'intérieur comme à l'extérieur. Des maisons privées aux musées. Des hôtels aux hôpitaux. Des restaurants aux bureaux. Des magasins aux piscines. Des sols de salles de bains aux façades de bâtiments. Nous proposons des carreaux de sol, de mur et de façade pour tous les usages. Et nous fabriquons toutes sortes d'éléments spéciaux pour répondre à presque toutes les exigences spécifiques, qu'il s'agisse d'une pièce spéciale pour une piscine ou d'un système de bande d'éveil intégré pour les personnes malvoyantes. Vous trouverez nos carreaux partout, dans le monde entier.

Versatile

Our products have applications far and wide. And inside and out. From private homes to museums. From hotels to hospitals. From restaurants to offices. From shops to swimming pools. From bathroom floors to building façades. We make floor, wall, and façade tiles for every purpose. And we manufacture all kinds of special elements to meet nearly every specific requirement, whether it is a moulded part for a pool, or an integrated guidance systems for visually impaired people. Our tiles find their way everywhere, the world over.



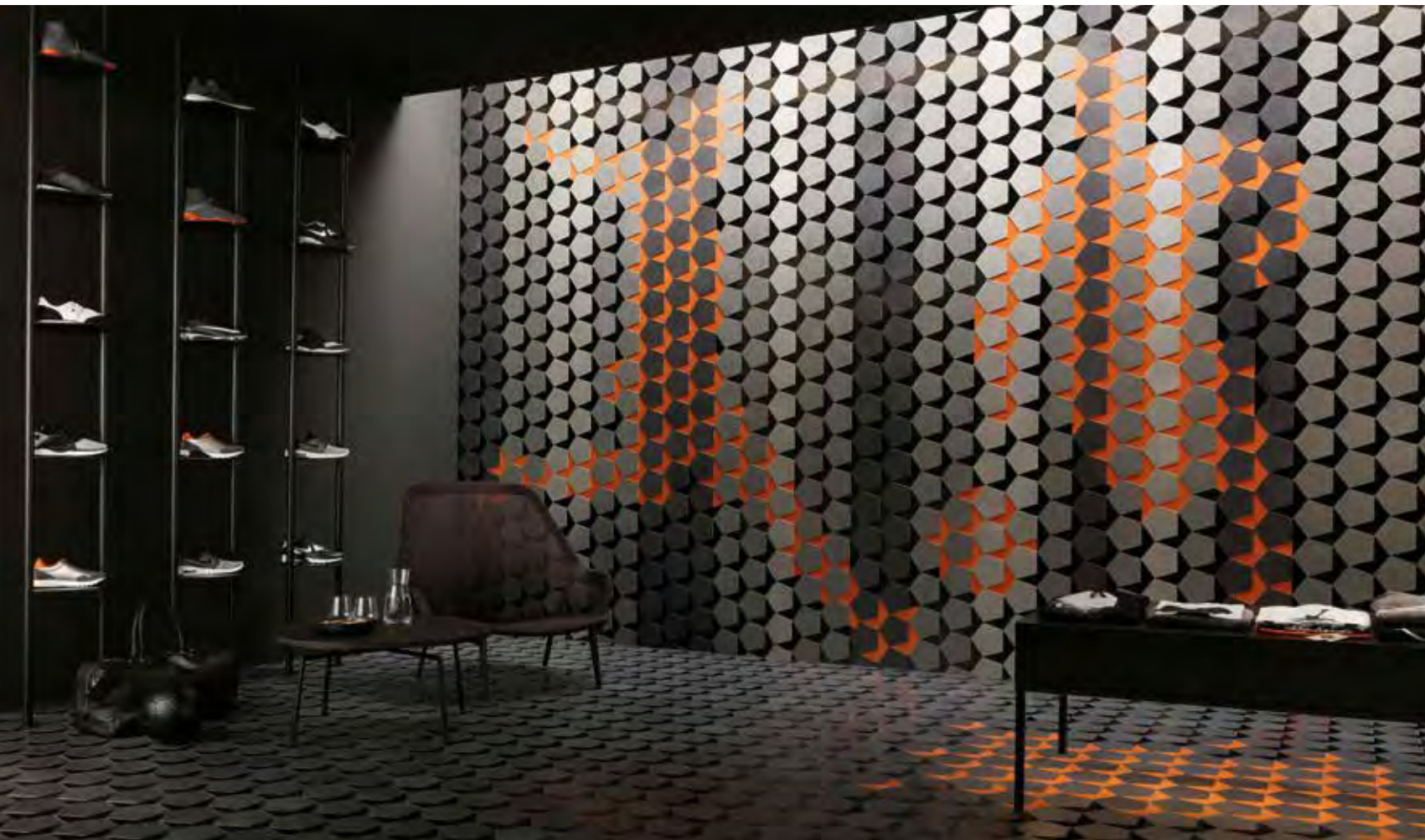

Kooperativ

Ganz gleich, wie gut unsere Produkte sind, wir glauben, dass nur ihre Anwendung ihre Qualitäten zur Geltung bringt. Deshalb schätzen wir Zusammenarbeit und freuen uns, unser Wissen zu teilen, um die beste Lösung für jedes Ihrer Architekturprojekte zu finden. Dort wo unsere Standardprodukte an ihre Grenzen gelangen, entwickeln wir maßgeschneiderte Lösungen. Sonderfertigungen sind unsere Spezialität. Wir haben die Expertise und die Erfahrung, um Architekten von der Ausschreibung bis zur Fertigstellung von Projekten zu unterstützen. Sagen Sie uns, wie wir Ihnen helfen können. Sagen Sie uns, wenn Sie hören möchten, was wir wissen.

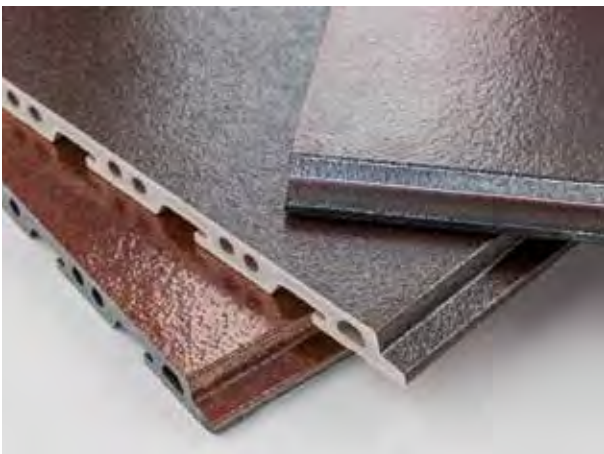

Collaboration

Quelle que soit la qualité de nos produits, nous pensons que seule leur application fait ressortir leurs qualités. C'est pourquoi nous apprécions la collaboration et sommes heureux de partager nos connaissances afin de trouver la meilleure solution pour chacun de vos projets architecturaux. Lorsque nos produits standards atteignent leurs limites, nous développons des solutions personnalisées. Les produits sur mesure sont notre spécialité. Nous disposons de l'expertise et de l'expérience nécessaires pour soutenir les architectes de l'appel d'offres à l'achèvement du projet. Faites-nous savoir comment nous pouvons vous aider. Faites-nous savoir lorsque vous souhaitez entendre ce que nous savons.

Collaborative

No matter how good our products are, we believe it is only their application which brings their qualities to fruition. That is why we value collaborations and treasure sharing our knowledge, to find the best solution for each of your architectural projects. Using our standard range of products when they suffice; offering a customized answer when warranted. Special solutions are our specialty. We have the expertise and experience to support architects, from tenders to the completion of projects. Tell us how we can help you. Tell us if you want to hear what we know.

Innovativ

Wir wissen, wie man großartige Fliesen herstellt. Dennoch arbeiten wir ununterbrochen daran, sie noch besser zu machen. Handwerkliches Können und neue Technologien verbinden sich bei der Schaffung innovativer rutschhemmender Oberflächen für Nassbereiche und der Entwicklung neuer und einfacher Verfahren zur Verarbeitung von Keramik, wie z. B. DryTile, das eine Verlegung ohne Kleber ermöglicht. Wir investieren in Gesundheit und Hygiene, wie unsere nachhaltige Hytect-Technologie zeigt, die in fast jedem von uns hergestellten Produkt Anwendung findet. Neben der Entwicklung von Innovationen in allen Bereichen sind wir stolz darauf, maßgeschneiderte neue Lösungen anzubieten und Architekten bei der Umsetzung ihrer besten Ideen zu unterstützen.

Innovation

Nous savons comment faire de grands carreaux. Néanmoins, nous nous efforçons constamment de les rendre encore meilleurs. L'artisanat et les nouvelles technologies se combinent dans la création de surfaces antidérapantes innovantes pour les zones humides et le développement de nouvelles méthodes simples de traitement de la céramique, telles que DryTile, qui permet la pose sans colle. Nous investissons dans la santé et l'hygiène, comme en témoigne notre technologie durable Hytect, qui est utilisée dans presque tous les produits que nous fabriquons. En plus de développer des innovations dans tous les domaines, nous sommes fiers de proposer de nouvelles solutions sur mesure et d'aider les architectes à donner vie à leurs meilleures idées.

Innovative

We know how to make great tiles. Yet we work incessantly to make them even better. Craftsmanship and new technology are combined in the creation of innovative non-slip surfaces for wet settings, and the development of new and easy ways to process ceramics, such as DryTile, which does not require any glue. We are invested in health and hygiene, as our sustainable Hytect technology shows, which is applied in nearly every product we manufacture. Aside from developing innovations across the board, we pride ourselves in offering bespoke new solutions, supporting architects to realize their best ideas.



Nachhaltig

Die Anforderungen an das Bauen wachsen kontinuierlich. Bauherren, Planer und Nutzer stellen neue Ansprüche, die auch die zukünftigen Entwicklungen stärker berücksichtigen. Energieeffizienz, Ressourcenschonung und Klimawandel sind hier die Stichworte, die entscheidenden Einfluss nehmen. Agrob Buchtal ist sich der Verantwortung zu nachhaltigem Bauen bewusst und unterstützt nachhaltiges Bauen nicht nur ideell über die Mitgliedschaft in der Deutschen Gesellschaft für Nachhaltiges Bauen (DGNB). Früh haben wir uns im Rahmen einer Umweltproduktdeklaration nach ISO14025 auf Branchenebene dazu entschlossen, alle für den Planungsprozess eines nachhaltigen Gebäudes wichtigen ökologischen Produktdaten transparent zu machen. Ob ein Gebäude unter Nachhaltigkeitsaspekten zu überzeugen vermag, lässt sich über Zertifizierungssysteme messbar machen. Hierzu müssen spezifische Produktinformationen zur Verfügung stehen und dokumentiert werden.

Durabilité

Les exigences auxquelles la construction doit satisfaire augmentent sans cesse. Les demandes des maîtres d'ouvrage, des planificateurs et des utilisateurs augmentent en incluant davantage les développements futurs. L'efficacité énergétique, la préservation des ressources et le changement climatique sont des mots-clés qui exercent une influence décisive. Connaissant sa responsabilité dans le domaine de la construction durable, AGROB BUCHTAL soutient non seulement l'idée de la construction durable en étant membre dans l'association allemande de construction durable (Deutsche Gesellschaft für Nachhaltiges Bauen (DGNB)), mais également concrètement : en effet, nous avons décidé rapidement dans le cadre d'une déclaration de produits écologiques selon ISO 14025 au niveau industriel d'accorder la transparence à toutes les données de produits écologiques importantes pour le procédé de planification d'un bâtiment durable. Le fait de convaincre sous l'aspect de durabilité peut être chiffré pour un bâtiment par des systèmes de certification. A cet effet, il faut prévoir et documenter des informations spécifiques sur les produits.

Sustainable

The requirements to be met in the construction sector are continuously increasing. Building owners, planners and users make new demands which also include the future developments to a great extent. Energy efficiency, preservation of resources and climate change are the key words in this connection, which have a decisive influence. Agrob Buchtal is aware of its responsibility with regard to sustainable building and supports not only the idea of sustainable building by its membership in the German association for sustainable building (Deutsche Gesellschaft für Nachhaltiges Bauen (DGNB)), but also the practical implementation: our industry has decided early – in the scope of an ecological product declaration according to ISO 14025 – to make all ecological product data important for the planning process of a sustainable building transparent. The fact whether a building is convincing from the point of view of sustainability can be determined by certification systems. For this, specific product information must be available and documented.

Wir sind vor Ort.

Sieben Standorte und weltweit verfügbar.

DSA Deutsche Steinzeug America, Inc



Ihre Vertriebsansprechpartner finden Sie auf Seite 234-235.
You will find your sales contacts on the pages 234-235.
Vous trouverez vos contacts commerciaux aux pages 234 à 235.

Nous sommes sur place.
Sept sites et disponibilité mondiale.
We are on site. Seven locations
and available world-wide.





HYTECT – DIE HYGIENE-FLIESE

THE HYGIENE TILE

LE CARREAU HYGIÉNIQUE

Hytect-Fliesen können einen bedeutenden Beitrag zur Wohngesundheit leisten. Denn die innovative Technologie reduziert Bakterien, Schimmel und Keime, baut Luftschadstoffe ab und sorgt dafür, dass Schmutz mühelos zu entfernen ist. Hytect funktioniert wie ein natürlicher Katalysator, der allein durch Lichteinfluss seine Wirkung entfaltet – und zwar dauerhaft. Denn Hytect ist fest in die Fliese eingebrannt und verbraucht sich nicht. Für eine nachhaltig gute Wohnqualität.

Les carreaux à finition Hytect peuvent avoir un très grand impact pour un habitat sain. Car cette technologie innovante réduit les bactéries, les moisissures et les germes, dégrade les polluants atmosphériques et facilite l'élimination de la saleté. Hytect fonctionne comme un catalyseur naturel, qui n'agit que sous l'effet de la lumière et cela de manière durable. Car Hytect est indissociablement scellé à l'émail lors de la cuisson et ne s'use pas. Pour une qualité de vie optimale dans la durée.

Hytect tiles can make an important contribution to healthy living. After all, this innovative technology reduces bacteria, mould and germs, breaks down pollutants in the air, and ensures that dirt can be easily removed. Hytect acts like a natural catalyst whose effects are triggered simply by light – and permanently. Hytect is inseparably and durably baked into the tile. For a sustainably good quality of living!

Weitere Infos



hytect.com





Nachhaltige Vorteile Avantages durables Sustainable advantages

- Mühelose Reinigung, spart Zeit und Putzmittel
 - Antibakteriell, sorgt für hygienische Sauberkeit
 - Reine Luft, wirkt positiv auf das Raumklima
 - Eine clevere Technologie für beste Wohnqualität
- Entretien sans efforts, gain de temps et de produits d'entretien
 - Antibactérien pour une propreté hygiénique
 - Purification de l'air avec un effet positif sur le climat intérieur
 - Technologie intelligente pour un confort de vie optimal
- Effortless cleaning, saving time and cleaning agents
 - Antibacterial, for hygienic cleanliness
 - Pure air, for a positive impact on the indoor climate
 - Clever technology, for optimum living quality

Hytect bedeutet weniger putzen, mehr Hygiene, frischere Luft und höchsten Komfort. So ist der Eingangsbereich immer einladend, der Wohnbereich stets salonfähig, das Bad ein keimfreier Wellness-Tempel und das Schlafzimmer eine wohltuende Ruhezone. Die smarte Art zu wohnen.

Hytect signifie facilité d'entretien, plus d'hygiène, un air plus frais et un confort maximal. Votre entrée sera toujours accueillante, l'espace de vie engageant, la salle de bain un temple du bien-être sans germes et la chambre à coucher un espace de détente apaisant. Pour un mode de vie intelligent.

Hytect means less cleaning, more hygiene, fresher air, and maximum comfort. For an entrance area which is always inviting, a living area which always looks respectable, a bathroom which is a germ-free wellness temple, and a bed-room which is a comforting rest area. The smart way to live.

Rutschhemmende Fliesen für alle Einsatzbereiche.

Stürze durch Ausrutschen, Stolpern/Umknicken oder Fehltreten sind in den meisten Betrieben und Einrichtungen ein Schwerpunkt Nr. 1. Rutschhemmende Fliesen, markiert durch das Gütesiegel „GRIP“, zählen zu unseren Kernkompetenzen. Seit der Markteinführung der ersten rutschhemmenden Fliesen in den 1930er Jahren wurde diese Innovation von uns durch intensive Forschung ständig weiterentwickelt. Zu den Ergebnissen zählen renommierte Preise für vorbildlich gestaltete Oberflächen, funktionelle Fortschritte wie geräuscharmes und rüttelfreies Befahren sowie mikrorauhe Spezialglasuren für den Barfußbereich in Schwimmbädern. Die Qualität unserer rutschhemmenden Fliesen wird durch permanente Kontrollen der Werkslabore gewährleistet und durch externe Institute sowie die Teilnahme an Ringversuchen mit akkreditierten Prüflabors regelmäßig neutral überwacht.

Carreaux antidérapants pour tous les domaines d'application.

Les chutes dues à des glissades, des trébuchements, des torsions ou des faux pas sont courantes sur la plupart des lieux de travail et des installations point noir primordial en matière d'accidents. Les carreaux antidérapants, marqués du label de qualité « GRIP », font partie de nos compétences clés. Depuis le lancement des premiers carreaux antidérapants au cours des années 1930, nous avons perfectionné cette innovation en permanence grâce à des recherches intensives. Les résultats incluent des récompenses prestigieuses pour des surfaces à conception exemplaire, des progrès fonctionnels tels la conduite silencieuse et sans vibrations, ainsi que les émaux spéciaux à micro-rugosité pour les zones pieds nus dans les piscines. La qualité de nos carreaux antidérapants est garantie par des contrôles permanents et impartiaux par des laboratoires de l'usine et par des instituts externes ainsi que par participation à des essais interlaboratoires auprès de laboratoires d'essai accrédités.

Slip-resistant tiles for for all areas of application.

Falls due to slipping, stumbling/twisting one's ankle or missteps are the primary cause of accidents in most companies and institutions. Slip-resistant tiles, marked by the quality seal "GRIP", are one of our core competences. Since the market launch of the first slip-resistant tiles in the 1930s, this innovation has been permanently further developed by us by intensive research. The results include renowned prizes for exemplary surface designs, functional improvements such as low-noise and vibration-free driving on ceramic coverings as well as micro-rough special glazes for the barefoot areas in swimming pools. The quality of our slip-resistant tiles is guaranteed by permanent controls of the in-house laboratories and neutrally supervised at regular intervals by external institutes as well as the participation in interlaboratory tests with accredited test laboratories.



Neuste Innovation bei rutschhemmenden Fliesen ist die R12V4

In Zusammenarbeit mit dem deutschen Designer Sebastian Herkner wurde eine spezielle rutschhemmende Oberfläche für Area Pro entwickelt. Sebastian Herkner war auf der Suche nach einem Muster, das spontan wirkt und dennoch eine gewisse Logik aufweist. So kam er zu den sich wiederholenden, trapezförmigen Rechtecken und dem Muster, das sich in alle vier Richtungen fortsetzen lässt. Area Pro ist mit diversen rutschhemmenden Oberflächen erhältlich, darunter Grid, mit einer Rutschhemmung von R12V4. Keine der rutschhemmenden Oberflächen beeinträchtigt die Ästhetik der Fliesen. Sie sind auch für großformatige Fliesen verfügbar, die aufgrund ihrer Eigenschaften auch in Großküchen verwendet werden dürfen.

La dernière innovation en matière de carreaux antidérapantes, c'est le R12V4

Une surface antidérapante spéciale pour Area Pro a été mise au point en collaboration avec le designer allemand Sebastian Herkner. Monsieur Herkner était à la recherche d'un motif dont l'effet est immédiat et qui possède pourtant une certaine logique. C'est ainsi qu'il est arrivé aux rectangles trapézoïdaux répétitifs et au motif qui peut être poursuivi dans les quatre directions. Area Pro est disponible avec différents revêtements antidérapants, dont Grid, avec une résistance au glissement de R12V4. Aucune des surfaces antidérapantes ne nuit à l'esthétique des carreaux. Elles sont également disponibles pour les carreaux grand format, dont l'utilisation est également autorisée dans les cuisines commerciales en raison de leurs propriétés.



Funktionalität und Schönheit vereint: Die Oberfläche R12V4 der Serie Area Pro. / Fonctionnalité et beauté combinées : La surface R12V4 de la série Area Pro. / Functionality and beauty combined: The R12V4 surface of the Area Pro series.

Latest innovation in the domain of slip-resistant tiles: R12V4

In cooperation with the German designer Sebastian Herkner, a special anti-slip surface was developed for Area Pro. Sebastian Herkner was looking for a design that looks spontaneous and yet has a certain logic. That's how he came up with the repeating trapezoidal rectangles and the pattern that can be continued in all four directions. Area Pro offers multiple slip-resistant surfaces, including the Grid, which comes with a non-slip grade of R12V4. None of the slip-resistant surfaces affect the tiles visually. Area Pro's non-slip surfaces are available in larger-sized tiles as well, which regulations now permit in professional kitchens.



Designer Sebastian Herkner entwickelt die rutschhemmende Oberfläche „Grid“. / Le designer Sebastian Herkner développe la surface antidérapante « Grid ». / Design luminary Sebastian Herkner dubbed the anti-slip surface Grid.



Das Design von Grid. / Le design de Grid / Designing the Grid.

Wir entwickeln Produktlösungen für alle Anwendungsbereiche.

Wand- und Bodenbeläge prägen den Gesamteindruck von Räumen maßgeblich. Bei der Planung zeitgemäßer Bäder und Wohnräume steht meist das Design an erster Stelle, wenn es um die Wahl von Wand und Bodenbelägen geht. Gleichzeitig sollen die Materialien zur Ausstattung von Arbeits- oder Esszimmer, Flur, Wohn- oder Badezimmer aber auch strapazierfähig und langlebig sein. Es kommt darauf an, Wohnkomfort ohne Kompromisse zu schaffen: ökologisch nachhaltig, pflegeleicht und barrierefrei. Wir bieten Produkte, die diese Anforderungen erfüllen und mit den Vorteilen der antibakteriellen Hytect-Oberfläche smarte Zusatznutzen schaffen. Vom Mosaik bis hin zu Großformaten.

Nous développons des solutions produits pour tous les domaines d'application.

Les revêtements de mur et de sol donnent une impression générale des pièces. De nos jours, le design est généralement la priorité absolue lorsqu'il s'agit de choisir les revêtements de mur et de sol lors de l'aménagement de salles de bains et d'espaces de vie. En même temps, les matériaux utilisés pour meubler le bureau, la salle à manger, le couloir, le salon ou la salle de bains doivent

également être résistants et durables. Il est important de créer un confort de vie sans compromis – écologiquement durable, facile à entretenir et sans obstacle. Nous proposons des produits qui répondent à ces exigences et créent des avantages supplémentaires intelligents grâce aux avantages de la surface antibactérienne Hytect. Des mosaïques aux grands formats.

We are developing product solutions for all areas of application.

Wall and floor coverings play a decisive role in the overall impression exuded by rooms and spaces. In planning contemporary bathrooms and living areas, design is usually attributed primary importance when it comes to choosing wall and floor coverings. At the same time, materials featured in studies or dining rooms, hallways, living rooms or bathrooms should also be durable and lasting. The goal is to create a comfortable living environment without making any compromises – ecologically sustainable, easy-care and barrier-free. We offer products which meet these requirements while the advantages of the antibacterial Hytect surface finish create smart extra benefits. From mosaics to large-format tiles.



Bäder – Smarte Lösungen mit hygienischer Oberfläche für ganzheitliche Planungen von Badezimmern und Gäste WC's.

Salles de bains – Des solutions intelligentes avec des surfaces hygiéniques pour une planification globale des salles de bains et des toilettes pour invités.

Bathrooms – Smart solutions with hygienic surfaces for comprehensive planning of bathrooms and guest WCs.



Wohnräume – Wand- und Bodenfliesen für nachhaltige wohngesunde Räume.

Espaces de vie – Carreaux de mur et de sol pour des espaces de vie durables et sains.

Living Areas – Wall and floor tiles for sustainable and healthy rooms.



Terrassenplatten – Im Sommer draußen zu Hause.
Dalles de terrasse – A la maison, en plein air en été.
Patio tiles – at home outside in summer.



Surf



DryTile –
Fliesen legen leicht gemacht.
La pose de carreaux en toute simplicité.
Tile laying made easy.

LIVING

Series	From page	Product category										Color										Look									
		Floor tiles	Decoration	Mosaic	Skirtings	Patio tiles	Stair tiles	Wall tiles	White	Light-grey	Mid-grey	Dark-grey	Black	Light-blue	Beige	Brown	Red	Green	Multicolored	Metallic	Mono-colored	Multicolored	Concrete	Wood	Industrial	Marble	Stone	Vintage			
Alcina	20	•	•	•	•	•	•	•	•	•	•	•	•	•													•				
Aruba	30	•	•	•		•	•	•	•	•	•		•														•				
Basis 1	38		•				•	•	•				•				•		•												
Cedra	46	•	•	•	•		•			•	•		•	•													•				
Como	54		•				•	•				•									•						•				
Concrete	58		•	•			•		•	•			•									•					•				
Evalia	64	•	•	•	•		•		•	•	•		•														•				
Focus Royal	72		•	•			•	•		•			•	•	•				•								•				
Jasba-CLARA	78			•			•	•	•			•			•	•											•				
Jasba-NIVELLA	104																														
Jasba-PATTERN	82	•		•			•	•	•	•	•		•				•		•								•				
Jasba-RONDA	90			•					•					•										•							
Jasba-SENJA PURE	94			•			•	•	•				•	•								•									
Jasba-VILLAGE	100			•					•	•			•	•													•				
Kiano	108	•	•	•	•	•	•	•	•	•			•	•				•			•										
La Casa	116		•	•			•	•	•	•			•	•				•	•								•				
Like	122	•	•	•	•	•	•		•	•	•																•				
Lunar	132	•	•	•	•		•		•	•	•		•	•													•				
Mandalay	138	•	•	•	•		•	•	•	•				•								•					•				
Mando	144		•				•	•		•			•	•								•									
Modern White	150		•				•	•		•		•				•		•	•					•							
Oak	156	•	•		•					•				•								•									
Pizarro	162	•	•			•	•	•		•	•	•															•				
Remix	166	•	•	•	•		•	•	•	•			•	•													•				
Sierra	176	•		•	•		•	•		•			•														•				
Sky	182		•				•	•	•	•			•	•								•		•							
Solid Rock	186	•	•	•	•	•		•	•	•																	•				
Soul	196	•		•	•		•		•	•				•							•										
Stories	202	•	•	•	•	•	•		•	•	•		•								•										
Timeless	212	•	•	•	•		•	•		•	•		•					•									•				
Trevi	218		•				•		•				•														•				
Urban Cotto	222	•			•				•				•	•									•				•				
Walden	226	•			•	•		•					•	•								•									

LIVING

Series	From page	Format																																			
		2.5 x 2.5 cm	5 x 5 cm	5 x 60 cm	10 x 10 cm	10 x 60 cm	15 x 15 cm	15 x 60 cm	15 x 90 cm	20 x 120 cm	20 x 20 cm	20 x 25 cm	20 x 40 cm	20 x 60 cm	22.5 x 90 cm	25 x 33 cm	25 x 44 cm	30 x 120 cm	30 x 30 cm	30 x 45 cm	30 x 60 cm	30 x 90 cm	35 x 100 cm	40 x 120 cm	45 x 90 cm	60 x 60 cm	60 x 120 cm	80 x 80 cm	90 x 90 cm	100 x 100 cm	120 x 120 cm						
Alcina	20	●																	●	●			●	●				●									
Aruba	30																			●	●			●	●												
Basis 1	38					●			●	●	●	●		●	●			●		●	●	●															
Cedra	46	●		●																●	●			●	●												
Como	54																				●																
Concrete	58																				●																
Evalia	64	●																			●	●			●	●											
Focus Royal	72																	●		●	●																
Jasba-CLARA	78			●		●																															
Jasba-NIVELLA	104																																				
Jasba-PATTERN	82	●	●	●					●																												
Jasba-RONDA	90	●	●																																		
Jasba-SENJA PURE	94	●	●									●									●	●															
Jasba-VILLAGE	100	●																																			
Kiano	108	●																●		●	●		●			●											
La Casa	116										●	●						●		●	●																
Like	122	●																			●	●			●		●						●				
Lunar	132	●																			●	●															
Mandalay1	138	●				●															●	●															
Mando	144																							●													
Modern White	150			●																	●	●															
Oak	156							●								●						●	●		●		●										
Pizarro	162																					●	●														
Remix	166	●						●														●	●			●											
Sierra	176	●																			●	●															
Sky	182																							●													
Solid Rock	186	●	●	●		●																●	●				●	●									
Soul	196	●																				●	●				●										
Stories	202	●																			●	●		●		●							●				
Timeless	212																				●	●				●	●										
Trevi	218																					●	●														
Urban Cotto	222																									●											
Walden	226								●																	●											





3D-Rendering, Stellwerk



Warm und natürlich

Für Wand und Boden in Wohn- und Nassbereichen bietet Alcina mit ihren natürlich strukturierten Oberflächen eine elegante Palette an erdigen und warmen Tönen. So lässt sich Alcina mit verschiedenen Wohnstilen kombinieren. Die zart eingefärbten Wandfliesen verfügen über eine Hytect-Oberfläche. Starke oder dezente Kontraste dazu bilden Bodenfliesen in unterschiedlichen Farben und Formaten. Für stilvolle Abwechslung sorgt das Schnittdekor Sola – in allen Bodenfarben. Passende Sockel sowie ein trittsicheres 5 x 5-Mosaik runden das breite Fliesenprogramm ab.

Chaleureux et naturel

Pour les murs et les sols des espaces d'habitat et des zones humides, Alcina offre une palette élégante de tons terreux et chaleureux grâce à ses surfaces naturellement structurées. De cette façon, Alcina peut être combinée avec différents styles de vie. Les carreaux de mur aux couleurs délicates ont une surface Hytect. Des contrastes forts ou subtils sont fournis par des carreaux de sol de couleurs et de formats différents. Le décor coupé Sola – dans toutes les couleurs de sol – assure le changement stylistique. Des plinthes assorties et une mosaïque 5 x 5 antidérapante complètent cette large gamme de carreaux.

Warm and natural

With its naturally textured surfaces, Alcina offers an elegant range of earthy and warm shades for walls and floors in living and wet areas. Accordingly, Alcina can be combined with various living styles. The delicately coloured wall tiles have a Hytect surface. Strong or subtle contrasts are created by floor tiles in different colours and formats. The Sola décor provides stylish variety – in all floor colours. This extensive range of tiles is rounded off by matching skirtings and non-slip 5 x 5 cm mosaics.



Art.	Nennmaß cote nominale nominal size cm	Herstellmaß cote de fabrication production size mm	m ²	Paket carton box	Palette palette pallet	Beanspr.-Gruppe groupe d'emploi wear resist. group	Norm Norme Standard	Trittsicherheit antidérapance non-slip	Preisgruppe groupe de prix price category
283059H	30 x 60	297 x 597 x 9	5,556 St pc	9 St pc	77,754 m ²		BIII GL		B69 (m ²)
283060H			14,946 kg	1,620 m ² 24,210 kg	1.162,080 kg		BIII GL		B69 (m ²)
393067H	30 x 90	297 x 897 x 10,5	3,704 St pc	5 St pc	32,397 m ²		BIII GL		B142 (m ²)
393068H			17,976 kg	1,350 m ² 24,265 kg	582,360 kg		BIII GL		B142 (m ²)

Wandfliese | carreau de mur | wall tile

Steingut glasiert | faïence émaillée | earthenware glazed

30 x 60 cm

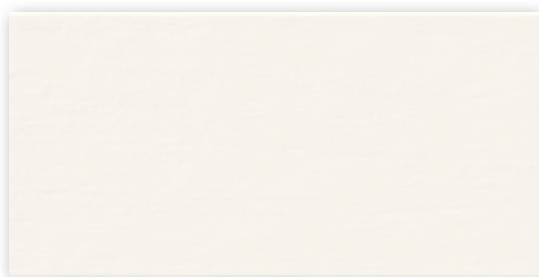
**283059H**

weiß | blanc | white

seidenmatt, strukturiert | satiné, structuré | silky-matt, structured

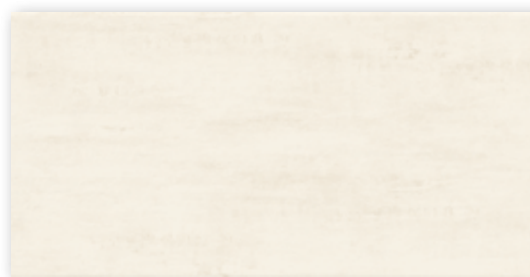
**283060H**

beige

seidenmatt, strukturiert | satiné, structuré | silky-matt, structured

30 x 90 cm

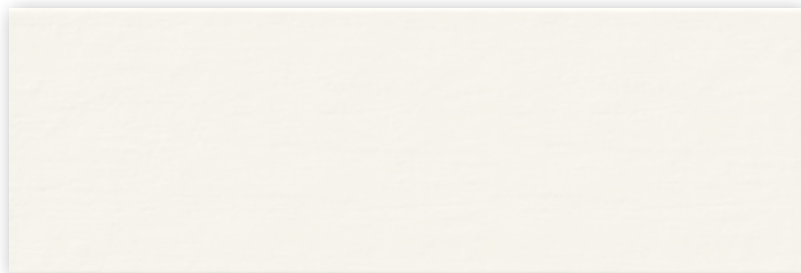
**393067H**

weiß | blanc | white

seidenmatt, strukturiert | satiné, structuré | silky-matt, structured

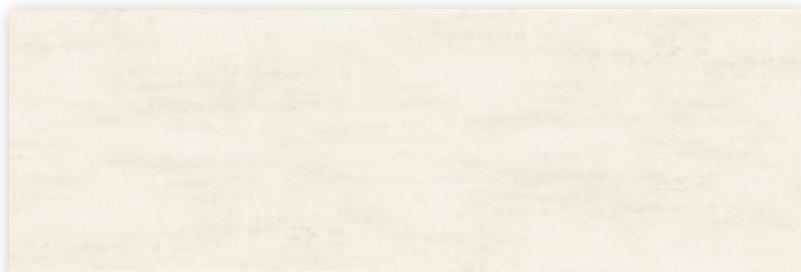
**393068H**

beige

seidenmatt, strukturiert | satiné, structuré | silky-matt, structured

Art.	Nennmaß cote nominale nominal size cm	Herstellmaß cote de fabrication production size mm	m	Paket carton box	Palette palette pallet	Beanspr.-Gruppe groupe d'emploi wear resist. group	Norm Norme Standard	Trittsicherheit antidérapance non-slip	Preisgruppe groupe de prix price category
283062							Bla UGL		B510 (St pc)
283063							Bla UGL		B510 (St pc)
283064	24,3 x 43,8	240 x 435 x 10,5	2,639 St pc	2 St pc			Bla UGL		B510 (St pc)
283065			5,388 kg	0,758 m	4,084 kg		Bla UGL		B510 (St pc)
283066							Bla UGL		B510 (St pc)

Dekorationselemente | éléments décoratifs | decoration elements

Bordüre Sola | bordure Sola | border Sola

Feinsteinzeugfliesen unglasiert | grès cérame fin vitrifié non-émaillés | porcelain stoneware tiles unglazed

24,3 x 43,8 cm

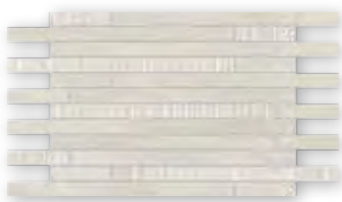

283062
crema
strukturiert, matt | structuré, mat | structured, matt



283063
lehm Braun | brun argile | clay-brown
strukturiert, matt | structuré, mat | structured, matt



283064
kieselgrau | gris galet | pebble-grey
strukturiert, matt | structuré, mat | structured, matt

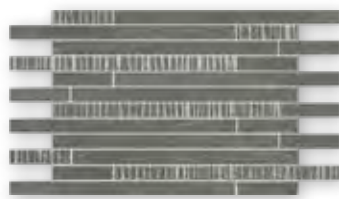

283065
basalt | basalte | basalt
strukturiert, matt | structuré, mat | structured, matt

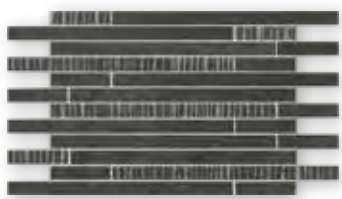

283066
graphit | graphite
strukturiert, matt | structuré, mat | structured, matt

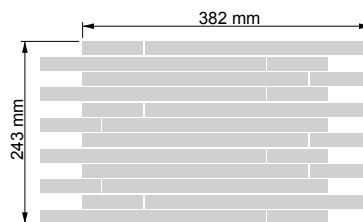

Bordüre, Verklebung rückseitig auf Glasfasernetz,
Bogen: 240 x 435 mm
Bordure, collée sur trame en fibre de verre à
l'envers, Feuille : 240 x 435 mm
Border, glass fibre net on reverse side,
Sheet: 240 x 435 mm

Abgabe der Dekorationselemente ausschließlich in vollen Kartons.
Éléments décoratifs uniquement livrables en cartons entiers.
Decoration elements only available in full boxes.

Art.	Nennmaß cote nominale nominal size cm	Herstellmaß cote de fabrication production size mm	m ²	Paket carton box	Palette palette pallet	Beanspr.-Gruppe groupe d'emploi wear resist. group	Norm Norme Standard	Trittsicherheit antidérapance non-slip	Preisgruppe groupe de prix price category
434816							Bla UGL	R9	B112 (m ²)
434817							Bla UGL	R9	B112 (m ²)
434818	30 x 60	297 x 597 x 10,5	5,556 St pc	6 St pc	43,197 m ²		Bla UGL	R9	B112 (m ²)
434819			23,224 kg	1,080 m ² 25,080 kg	1.003,200 kg		Bla UGL	R9	B112 (m ²)
434820							Bla UGL	R9	B112 (m ²)



crema

V2

lehmbraun
brun argile
clay-brown

V2

kieselgrau
gris galet
pebble-grey

V2

basalt
basalte
basalt

V2

graphit
graphite

V2

Bodenfliese | carreau de sol | floor tile

Feinsteinzeugfliesen unglasiert | grès cérame fin vitrifié non-émaillés | porcelain stoneware tiles unglazed

30 x 60 cm



434816

crema
strukturiert, matt | structuré, mat | structured, matt

434817

lehmbraun | brun argile | clay-brown
strukturiert, matt | structuré, mat | structured, matt

434818

kieselgrau | gris galet | pebble-grey
strukturiert, matt | structuré, mat | structured, matt

434819

basalt | basalte | basalt
strukturiert, matt | structuré, mat | structured, matt

434820

graphit | graphite
strukturiert, matt | structuré, mat | structured, matt

Art.	Nennmaß cote nominale nominal size cm	Herstellmaß cote de fabrication production size mm	m ²	Paket carton box	Palette palette pallet	Beanspr.-Gruppe groupe d'emploi wear resist. group	Norm Norme Standard	Trittsicherheit antidérapance non-slip	Preisgruppe groupe de prix price category
434821							Bla UGL	R9	B126 (m ²)
434822							Bla UGL	R9	B126 (m ²)
434823	60 x 60	597 x 597 x 10,5	2,778 St pc	3 St pc	38,877 m ²		Bla UGL	R9	B126 (m ²)
434824			23,769 kg	1,080 m ²	25,668 kg		Bla UGL	R9	B126 (m ²)
434825							Bla UGL	R9	B126 (m ²)
434831							Bla UGL	R9	B152 (m ²)
434832							Bla UGL	R9	B152 (m ²)
434833	45 x 90	447 x 897 x 10,5	2,470 St pc	2 St pc	32,389 m ²		Bla UGL	R9	B152 (m ²)
434834			23,070 kg	0,810 m ²	18,680 kg		Bla UGL	R9	B152 (m ²)
434835							Bla UGL	R9	B152 (m ²)

Bodenfliese | carreau de sol | floor tile

Feinsteinzeugfliesen unglasiert | grès cérame fin vitrifié non-émaillés | porcelain stoneware tiles unglazed

60 x 60 cm



434821

crema
strukturiert, matt | structuré, mat | structured, matt

434822

lehmbraun | brun argile | clay-brown
strukturiert, matt | structuré, mat | structured, matt

434823

kieselgrau | gris galet | pebble-grey
strukturiert, matt | structuré, mat | structured, matt

434824

basalt | basalte | basalt
strukturiert, matt | structuré, mat | structured, matt

434825

graphit | graphite
strukturiert, matt | structuré, mat | structured, matt

45 x 90 cm *



434831

crema
strukturiert, matt | structuré, mat | structured, matt

434832

lehmbraun | brun argile | clay-brown
strukturiert, matt | structuré, mat | structured, matt

434833

kieselgrau | gris galet | pebble-grey
strukturiert, matt | structuré, mat | structured, matt

434834

basalt | basalte | basalt
strukturiert, matt | structuré, mat | structured, matt

434835

graphit | graphite
strukturiert, matt | structuré, mat | structured, matt

* Achtung: Sonderpalette. Keine Rücknahme, kein Umtausch.

* Attention : palette spéciale. Pas de retour, pas d'échange.

* Please note: special pallet. No return, no exchange.

Art.	Nennmaß cote nominale nominal size cm	Herstellmaß cote de fabrication production size mm	m ²	Paket carton box	Palette palette pallet	Beanspr.-Gruppe groupe d'emploi wear resist. group	Norm Norme Standard	Trittsicherheit antidérapance non-slip	Preisgruppe groupe de prix price category
434895							Bla UGL	R9	B142 (m ²)
434896	90 x 90	895 x 895 x 11,0	1,234 St pc	2 St pc	48,622 m ²		Bla UGL	R9	B142 (m ²)
434897			24,691 kg	1,621 m ² 40,018 kg	1.200,540 kg		Bla UGL	R9	B142 (m ²)



kieselgrau
gris galet
pebble-grey



basalt
basalte
basalt



graphit
graphite



Bodenfliese | carreau de sol | floor tile

Feinsteinzeugfliesen unglasiert | grès cérame fin vitrifié non-émaillés | porcelain stoneware tiles unglazed

90 x 90 cm *



434895

kieselgrau | gris silex | pebble grey
strukturiert, matt | structuré, mat | structured, matt

434896

basalt | basalte
strukturiert, matt | structuré, mat | structured, matt

434897

graphit | graphite
strukturiert, matt | structuré, mat | structured, matt

* Achtung: Sonderpalette. Keine Rücknahme, kein Umtausch.
* Attention : palette spéciale. Pas de retour, pas d'échange.
* Please note: special pallet. No return, no exchange.

Art.	Nennmaß cote nominale nominal size cm	Herstellmaß cote de fabrication production size mm	m ²	Paket carton box	Palette palette pallet	Beanspr.-Gruppe groupe d'emploi wear resist. group	Norm Norme Standard	Trittsicherheit antidérapance non-slip	Preisgruppe groupe de prix price category
434983H							Bla UGL	R11/B	B151 (m ²)
434984H	60 x 60	597 x 597 x 20	2,778 St pc	2 St pc	21,598 m ²		Bla UGL	R11/B	B151 (m ²)
434985H			45,273 kg	0,720 m ² 32,594 kg	977,820 kg		Bla UGL	R11/B	B151 (m ²)

Terrassenplatte | dalle de terrasse | patio tile

Feinsteinzeugfliesen unglasiert | grès cérame fin vitrifié non-émaillés | porcelain stoneware tiles unglazed

60 x 60 cm*



434983H

kieselgrau | gris silex | pebble grey
strukturiert, matt | structuré, mat | structured, matt

434984H

basalt | basalte
strukturiert, matt | structuré, mat | structured, matt

434985H

graphit | graphite
strukturiert, matt | structuré, mat | structured, matt

* Hohes Gewicht! Karton bitte nur zu Zweit transportieren.

* Poids élevé ; a transporter par deux personnes seulement.

* High weight only to carry with two persons.

Art.	Nennmaß cote nominale nominal size cm	Herstellmaß cote de fabrication production size mm	m ² /m	Paket carton box	Palette palette pallet	Beanspr.-Gruppe groupe d'emploi wear resist. group	Norm Norme Standard	Trittsicherheit antidérapance non-slip	Preisgruppe groupe de prix price category
434826							Bla UGL		B440 (St pc)
434827							Bla UGL		B440 (St pc)
434828	7 x 60	70 x 597 x 10,5	1,667 St pc / m	15 St pc			Bla UGL		B440 (St pc)
434829			1,584 kg	8,998 m	14,250 kg / m		Bla UGL		B440 (St pc)
434830							Bla UGL		B440 (St pc)
434801							Bla UGL	R10/B	B284 (m ²)
434802							Bla UGL	R10/B	B284 (m ²)
434803	5 x 5	47 x 47 x 10,5	11,111 Bögen plaques sheets	11 Bögen plaques sheets	29,700 m ²		Bla UGL	R10/B	B284 (m ²)
434804			22,222 kg / m ²	0,990 m ²	22,000 kg	660,000 kg	Bla UGL	R10/B	B284 (m ²)
434805							Bla UGL	R10/B	B284 (m ²)



crema



lehm Braun
brun argile
clay-brown



kieselgrau
gris galet
pebble-grey



basalt
basalte
basalt



graphit
graphite



Sockel, gerundet | plinthe, arrondie | skirting, rounded

Feinsteinzeugfliesen unglasiert | grès cérame fin vitrifié non-émaillés | porcelain stoneware tiles unglazed

7 x 60 cm



434826

crema
strukturiert, matt | structuré, mat |
structured, matt

434828

kieselgrau | gris galet | pebble-grey
strukturiert, matt | structuré, mat |
structured, matt

434830

graphit | graphite
strukturiert, matt | structuré, mat |
structured, matt

434827

lehm Braun | brun argile | clay-brown
strukturiert, matt | structuré, mat |
structured, matt

434829

basalt | basalte | basalt
strukturiert, matt | structuré, mat |
structured, matt

Mosaik | mosaïque | mosaic

Feinsteinzeugfliesen unglasiert | grès cérame fin vitrifié non-émaillés | porcelain stoneware tiles unglazed

5 x 5 cm

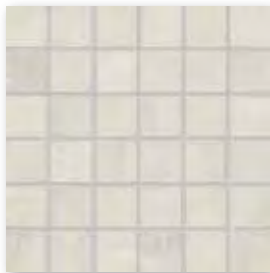

434801

crema
strukturiert, matt | structuré, mat |
structured, matt

434802

lehm Braun | brun argile | clay-brown
strukturiert, matt | structuré, mat |
structured, matt

434803

kieselgrau | gris galet | pebble-grey
strukturiert, matt | structuré, mat |
structured, matt

434804

basalt | basalte | basalt
strukturiert, matt | structuré, mat |
structured, matt

434805

graphit | graphite
strukturiert, matt | structuré, mat |
structured, matt

Mosaik, Verklebung
rückseitig auf Glasfasernetz,
Bogen: 297 x 297 mm

Mosaïque, collée sur trame
en fibre de verre à l'envers,
Feuille : 297 x 297 mm

Mosaic, glass fibre net
on reverse side,
Sheet: 297 x 297 mm

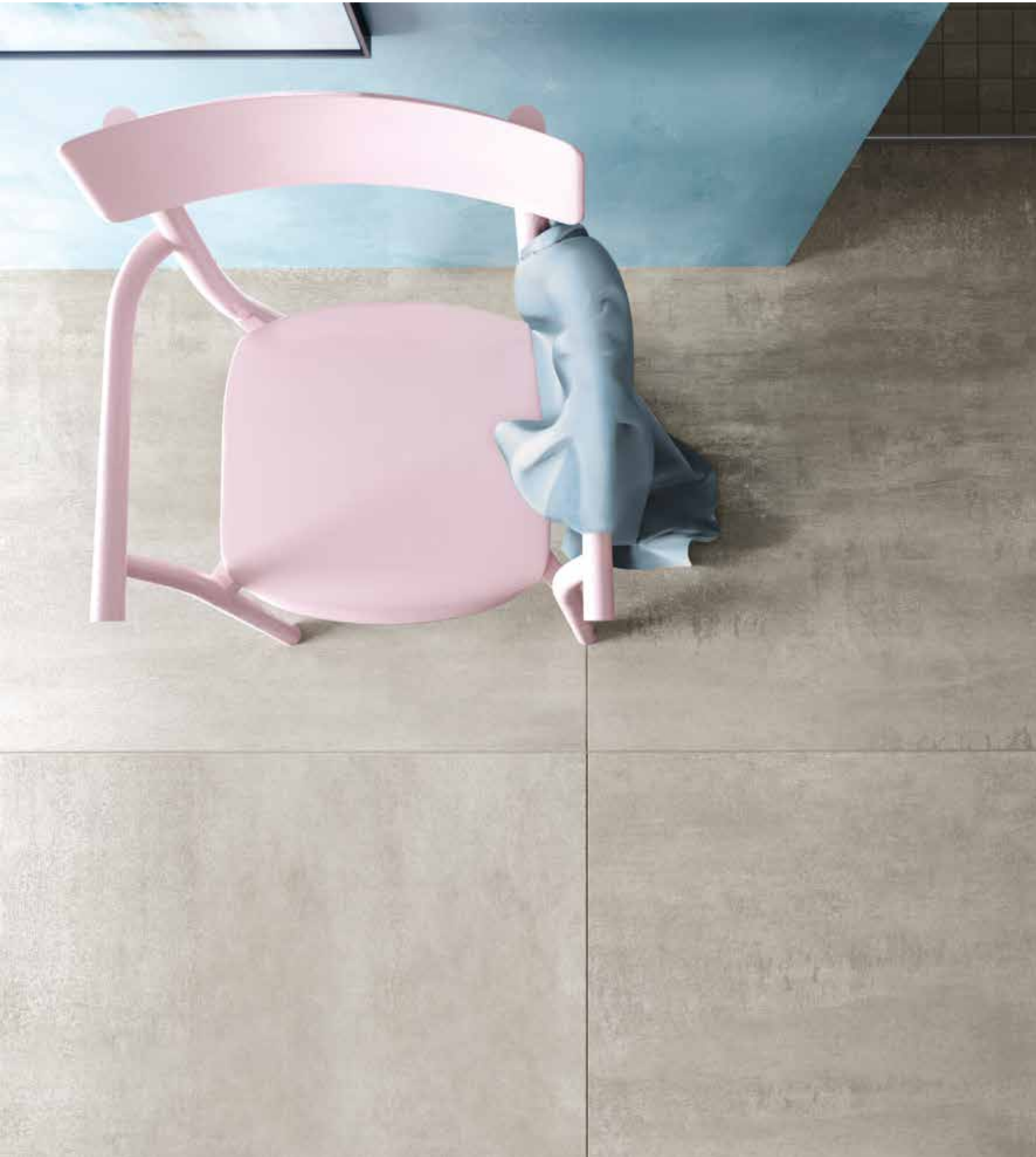

Spiel mit Bewegung und Transparenz.

Die Serie Aruba ist puristisch, harmonisch und ideal für private Bäder. In warmweißen Farben und Sandtönen gibt es sie als Wandfliese und Dekorfliese Kentia mit Palmlätter-Motiven. Die Dekorfliesen können frei nach Wahl angeordnet werden und sind richtungslos verlegbar sowie im Riegelformat erhältlich. Das und ihr spezielles Fliesenbild gibt beim Verlegen alle optischen Freiheiten. Es macht zudem die filigrane Rhythmisierung des Fliesenbildes möglich und bringt die Bewegung der Blätter besonders zur Geltung. Die Bodenfliesen runden das Angebot ab, auch in der besonders repräsentativen Dimension 60 x 120 und im optisch ansprechenden Mosaik-Format. Durch die Hytect-Oberfläche ist die gesamte Serie sehr pflegeleicht, sie wirkt antibakteriell und sorgt für hygienische Sauberkeit.

Jouez avec le mouvement et la transparence.

La série Aruba est puriste, harmonieuse et idéale pour les salles de bains privées. Dans des couleurs blanches chaudes et des tons sableux, elle est disponible en carreaux de mur et en carreaux décoratifs Kentia avec des motifs de feuilles de palmier. Les carreaux décoratifs peuvent être disposés à volonté et peuvent être posés sans direction. Ils sont également disponibles en format de traverse. Grâce à cette particularité et leur aspect spécial, ces carreaux offrent une grande liberté visuelle lors de la pose. Cela permet également le rythme filigrane du motif des carreaux et fait ressortir le mouvement des feuilles en particulier. Les carreaux de sol complètent la gamme, également dans le format particulièrement prestigieux de 60 x 120 et dans le format mosaïque visuellement attrayant. La surface Hytect rend toute la série très facile à nettoyer ; elle a un effet antibactérien et assure une propreté hygiénique.

Play with movement and transparency.

The Aruba series is puristic, harmonious and ideal for private bathrooms. In warm white colors and sandy shades, it is available as wall tile and Kentia decorative tile with palm leaf motifs. The decorative tiles can be arranged as desired and can be laid without specific direction. They are available in oblong format. This and their special tile pattern offer unlimited visual freedom when laying. It also makes the filigree rhythm of the tile pattern possible and particularly emphasizes the movement of the leaves. The floor tiles round off the range, also in the particularly representative size of 60 x 120 and in the visually appealing mosaic format. The Hytect surface makes the entire series very easy to clean; it has an antibacterial effect and ensures hygienic cleanliness.





Art.	Nennmaß cote nominale nominal size cm	Herstellmaß cote de fabrication production size mm	m ²	Paket carton box	Palette palette pallet	Beanspr.-Gruppe groupe d'emploi wear resist. group	Norm Norme Standard	Trittsicherheit antidérapance non-slip	Preisgruppe groupe de prix price category
203225H	30 x 60	297 x 597 x 6	5,556 St pc	13 St pc	112,311 m ²		BIII GL		B65 (m ²)
203226H			10,279 kg	2,340 m ² 24,050 kg	1.154,400 kg		BIII GL		B65 (m ²)
323227H	30 x 90	297 x 897 x 6	3,704 St pc	8 St pc	51,836 m ²		BIII GL		B142 (m ²)
323228H			10,400 kg	2,160 m ² 22,464 kg	539,136 kg		BIII GL		B142 (m ²)

Wandfliese | carreau de mur | wall tile

Steingut glasiert | faïence émaillée | earthenware glazed

30 x 60 cm

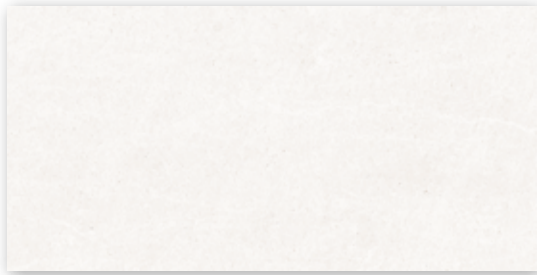

203225H

white

seidenmatt, eben | satinée, lisse | silky-matt, smooth

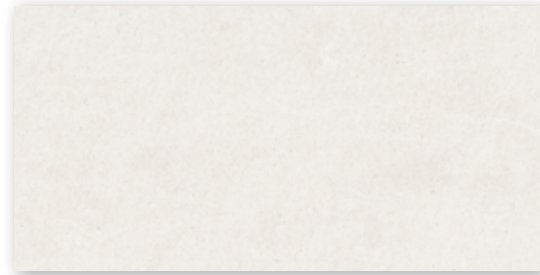

203226H

sand

seidenmatt, eben | satinée, lisse | silky-matt, smooth

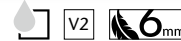

30 x 90 cm

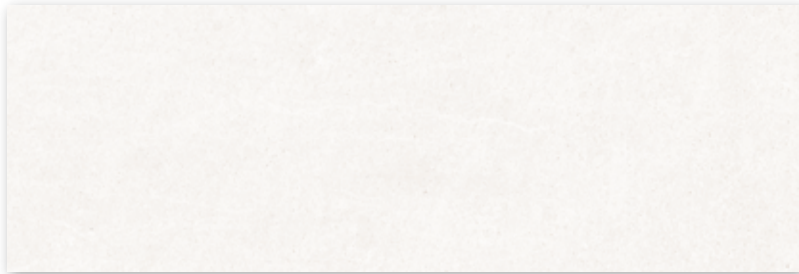

323227H

white

seidenmatt, eben | satinée, lisse | silky-matt, smooth

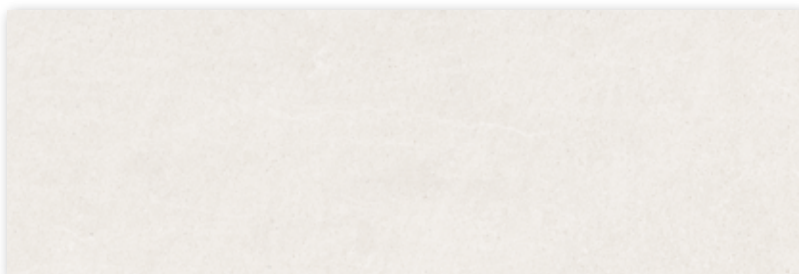
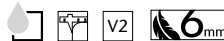

323228H

sand

seidenmatt, eben | satinée, lisse | silky-matt, smooth

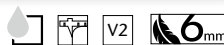

Art.	Nennmaß cote nominale nominal size cm	Herstellmaß cote de fabrication production size mm	m ²	Paket carton box	Palette palette pallet	Beanspr.-Gruppe groupe d'emploi wear resist. group	Norm Norme Standard	Trittsicherheit antidérapance non-slip	Preisgruppe groupe de prix price category
203229H	30 x 60	297 x 597 x 6	5,556 St m ² 10,279 kg	13 St pc 2,340 m ² 24,050 kg	112,311 m ² 1.154,400 kg		BIII GL	B82 (m ²)	
323230H	30 x 90	297 x 897 x 6	3,704 St m ² 10,400 kg	8 St pc 2,160 m ² 22,464 kg	51,836 m ² 539,136 kg		BIII GL	B152 (m ²)	
203333H	7,5 x 25	72 x 247 x 6	53,333 St m ² 9,813 kg	18 St pc 0,338 St m ² 3,123 kg	56,700 m ² 556,416 kg		BIII GL	B182 (m ²)	

Dekorationselemente | éléments décoratifs | decoration elements

Dekorfliese Kentia | carreau décoratif Kentia | decorative element Kentia

Steingut glasiert | faïence émaillée | earthenware glazed

30 x 60 cm



203229H

sand white

seidenmatt, eben | satinée, lisse | silky-matt, smooth



30 x 90 cm



323230H

sand white

seidenmatt, eben | satinée, lisse | silky-matt, smooth

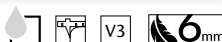

7,5 x 25 cm Riegelformat | format de traverse | oblong format



203333H

sand white

seidenmatt, eben | satinée, lisse | silky-matt, smooth



Abgabe der Dekorationselemente ausschließlich in vollen Kartons.
Éléments décoratifs uniquement livrables en cartons entiers.
Decoration elements only available in full boxes.

Art.	Nennmaß cote nominale nominal size cm	Herstellmaß cote de fabrication production size mm	m ²	Paket carton box	Palette palette pallet	Beanspr.-Gruppe groupe d'emploi wear resist. group	Norm Norme Standard	Trittsicherheit antidérapance non-slip	Preisgruppe groupe de prix price category
430834H							Alb UGL	R9	B112 (m ²)
430835H	30 x 60	297 x 597 x 8	5,556 St pc	6 St pc	43,197 m ²		Alb UGL	R9	B112 (m ²)
430836H			17,413 kg	1,080 m ² 18,804 kg	752,160 kg		Alb UGL	R9	B112 (m ²)
430837H							Alb UGL	R9	B112 (m ²)
430838H							Alb UGL	R9	B126 (m ²)
430839H	60 x 60	597 x 597 x 8	2,778 St pc	4 St pc	43,197 m ²		Alb UGL	R9	B126 (m ²)
430840H			18,001 kg	1,440 m ² 25,920 kg	777,600 kg		Alb UGL	R9	B126 (m ²)
430841H							Alb UGL	R9	B126 (m ²)



pearl

V3



mud

V3



stone

V3



graphite

V3

Bodenfliese | carreau de sol | floor tile

Feinsteinzeugplatten unglasiert | grès fin non-émaillés | porcelain stoneware tiles unglazed

30 x 60 cm



430834H

pearl
strukturiert, matt
structuré, mat
structured, matt



430835H

mud
strukturiert, matt
structuré, mat
structured, matt

430836H

stone
strukturiert, matt
structuré, mat
structured, matt

430837H

graphite
strukturiert, matt
structuré, mat
structured, matt

60 x 60 cm



430838H

pearl
strukturiert, matt
structuré, mat
structured, matt

430839H

mud
strukturiert, matt
structuré, mat
structured, matt

430840H

stone
strukturiert, matt
structuré, mat
structured, matt

430841H

graphite
strukturiert, matt
structuré, mat
structured, matt



Art.	Nennmaß cote nominale nominal size cm	Herstellmaß cote de fabrication production size mm	m ²	Paket carton box	Palette palette pallet	Beanspr.-Gruppe groupe d'emploi wear resist. group	Norm Norme Standard	Trittsicherheit antidérapance non-slip	Preisgruppe groupe de prix price category
430842H							Alb UGL	R9	B152 (m ²)
430843H	60 x 120	597 x 1197 x 8	1,388 St pc	2 St pc	36,023 m ²		Alb UGL	R9	B152 (m ²)
430844H			17,489 kg	1,441 m ² 25,200 kg	630,000 kg		Alb UGL	R9	B152 (m ²)
430845H							Alb UGL	R9	B152 (m ²)

Bodenfliese | carreau de sol | floor tile

Feinsteinzeugplatten unglasiert | grès fin non-émaillés | porcelain stoneware tiles unglazed

60 x 120 cm



430842H

pearl
strukturiert, matt
structuré, mat
structured, matt

430843H

mud
strukturiert, matt
structuré, mat
structured, matt

430844H

stone
strukturiert, matt
structuré, mat
structured, matt

430845H

graphite
strukturiert, matt
structuré, mat
structured, matt



Art.	Nennmaß cote nominale nominal size cm	Herstellmaß cote de fabrication production size mm	m	Paket carton box	Palette palette pallet	Beanspr.-Gruppe groupe d'emploi wear resist. group	Norm Norme Standard	Trittsicherheit antidérapance non-slip	Preisgruppe groupe de prix price category
430846H							Alb UGL	R9	B466 (St pc)
430847H	30 x 60	297 x 597 x 8	1,667 St pc	6 St pc			Alb UGL	R9	B466 (St pc)
430848H			5,224 kg	3,599 m	18,804 kg		Alb UGL	R9	B466 (St pc)
430849H							Alb UGL	R9	B466 (St pc)
430850H							Alb UGL		B440 (St pc)
430851H	7 x 60	70 x 597 x 8	1,667 St pc	15 St pc			Alb UGL		B440 (St pc)
430797H			1,219 kg	8,998 m	10,969 kg		Alb UGL		B440 (St pc)
430798H							Alb UGL		B440 (St pc)



pearl

V3



mud

V3



stone

V3

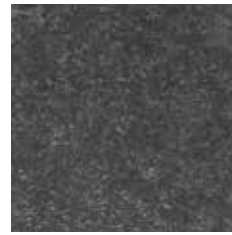

graphite

V3

Treppenfliese | nez de marche | stair tile

Feinsteinzeugplatten unglasiert | grès fin non-émaillés | porcelain stoneware tiles unglazed

30 x 60 cm



430846H

pearl
strukturiert, matt
structuré, mat
structured, matt

430847H

mud
strukturiert, matt
structuré, mat
structured, matt

430848H

stone
strukturiert, matt
structuré, mat
structured, matt

430849H

graphite
strukturiert, matt
structuré, mat
structured, matt

Auftragsfertigung: Rückgabe
und/oder Stornierung bestellter
Ware nicht möglich.

Fabrication sur commande :
il nous est impossible d'accepter
l'annulation de commandes
d'articles ou le retour d'articles.

Make-to-order production:
return and/or cancellation of
ordered products not possible.



Sockel, gerundet | plinthe, arrondie | skirting, rounded

Feinsteinzeugfliesen unglasiert | grès cérame fin vitrifié non-émaillés | porcelain stoneware tiles unglazed

7 x 60 cm

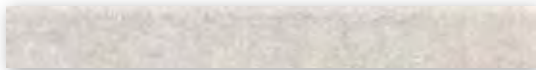

430850H

pearl
strukturiert, matt
structuré, mat
structured, matt

430851H

mud
strukturiert, matt
structuré, mat
structured, matt

430797H

stone
strukturiert, matt
structuré, mat
structured, matt

430798H

graphite
strukturiert, matt
structuré, mat
structured, matt









Zeitlos und schlicht

Die zeitlose Farbpalette und Formate erlauben wirtschaftliche Lösungen in unterschiedlichen Bereichen. Sie bietet in verschiedenen Oberflächen (matt, glänzend, gehämmert, gewellt) eine Vielzahl von Formaten vom kleinen 15 x 15 cm Produkt bis hin zu dem imposanten Großformat 35 x 100 cm.

Hors temps et simple

La gamme de couleurs hors temps de la série permet des solutions économiques dans différents domaines. Elle offre une variété de formats en différentes surfaces (mat, brillant, martelé, ondulé), du petit produit de 15 x 15 cm au grand format impressionnant de 35 x 100 cm.

Timeless and simple

The timeless colour range of the series permits economical solutions in different areas. It offers a variety of formats with diverse surfaces (matt, glossy, hammered, undulated), from the small 15 x 15 cm product to the imposing large format of 35 x 100 cm.

BASIS 1

Art.	Nennmaß cote nominale nominal size cm	Herstellmaß cote de fabrication production size mm	m ²	Paket carton box	Palette palette pallet	Beanspr.-Gruppe groupe d'emploi wear resist. group	Norm Norme Standard	Trittsicherheit antidérapance non-slip	Preisgruppe groupe de prix price category
112000							BIII GL	A24 (m ²)	
115100	15 x 15	150 x 150 x 5,0	44,000 St pc	44 St pc	105,000 m ²		BIII GL	A24 (m ²)	
113063			9,812 kg	1,000 m ² 9,812 kg	1.030,260 kg		BIII GL	A67 (m ²)	
111052							BIII GL	A67 (m ²)	
531910-148	15 x 15	147 x 147 x 5,0	44,000 St pc	44 St pc	105,000 m ²		BIII GL	A24 (m ²)	
531911-148			9,812 kg	1,000 m ² 9,812 kg	1.030,260 kg		BIII GL	A24 (m ²)	
173339							BIII GL	A67 (m ²)	
173340	15 x 30	147 x 297 x 6,5	22,222 St pc	24 St pc	91,801 m ²		BIII GL	A67 (m ²)	
173368			9,955 kg	1,080 m ² 910,752 kg	913,920 kg		BIII GL	A55 (m ²)	
173369							BIII GL	A55 (m ²)	
213341							BIII GL	A40 (m ²)	
213342	20 x 20	197 x 197 x 6,0	25,000 St pc	25 St pc	96,000 m ²		BIII GL	A40 (m ²)	
532230-800			10,800 kg	1,000 m ² 10,800 kg	1.036,800 kg		BIII GL	A24 (m ²)	
532212-800							BIII GL	A24 (m ²)	

Wandfliese | carreau de mur | wall tile

Steingut glasiert | faïence émaillée | earthenware glazed

15 x 15 cm

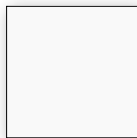

112000

weiß, glänzend, eben
blanc, brillant, lisse
white, glossy, smooth

115100

weiß, matt, eben
blanc, mat, lisse
white, matt, smooth

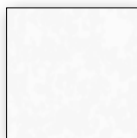

113063

weiß, glänzend, gehämmert, eben
blanc, brillant, martelé, lisse
white, glossy, hammered, smooth

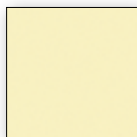

111052

elfenbein, glänzend, eben
ivoire, brillant, lisse
ivory, glossy, smooth

15 x 30 cm

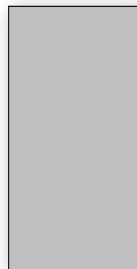

173339

hellgrau, matt, eben
gris clair, mat, lisse
light-grey, matt, smooth

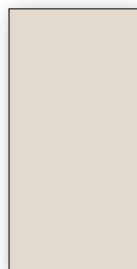

173340

hellbeige, matt, eben
beige clair, mat, lisse
light-beige, matt, smooth



173368

weiß, glänzend, eben
blanc, brillant, lisse
white, glossy, smooth

173369

weiß, matt, eben
blanc, mat, lisse
white, matt, smooth

20 x 20 cm



532230-800

weiß, glänzend, eben
blanc, brillant, lisse
white, glossy, smooth

532212-800

weiß, matt, eben
blanc, mat, lisse
white, matt, smooth

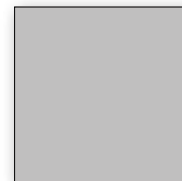

213341

hellgrau, matt, eben
gris clair, mat, lisse
light-grey, matt, smooth

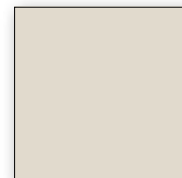

213342

hellbeige, matt, eben
beige clair, mat, lisse
light-beige, matt, smooth

Art.	Nennmaß cote nominale nominal size cm	Herstellmaß cote de fabrication production size mm	m ²	Paket carton box	Palette palette pallet	Beanspr.-Gruppe groupe d'emploi wear resist. group	Norme Norme Standard	Trittsicherheit antidérapance non-slip	Preisgruppe groupe de prix price category
538020-400							BIII GL	A31 (m ²)	
538021-400							BIII GL	A31 (m ²)	
538260-400	20 x 25	198 x 248 x 6,0	20,000 St pc	20 St pc	92,000 m ²		BIII GL	A31 (m ²)	
538261-400			10,620 kg	1,000 m ² 10,620 kg	977,040 kg		BIII GL	A31 (m ²)	
538280-400							BIII GL	A31 (m ²)	
538281-400							BIII GL	A31 (m ²)	
182763							BIII GL	A40 (m ²)	
182764	20 x 40	197 x 397 x 7,5	12,500 St pc	16 St pc	92,160 m ²		BIII GL	A40 (m ²)	
183343			12,638 kg	1,280 m ² 16,176 kg	1.164,672 kg		BIII GL	A55 (m ²)	
183344							BIII GL	A55 (m ²)	
381474	20 x 60	197 x 597 x 9,0	8,333 St pc	8 St pc	61,442 m ²		BIII GL	A81 (m ²)	
381475			15,516 kg	0,960 m ² 14,896 kg	953,344 kg		BIII GL	A81 (m ²)	

Wandfliese | carreau de mur | wall tile

Steingut glasiert | faïence émaillée | earthenware glazed

20 x 25 cm

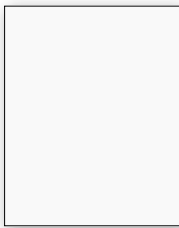

538020-400

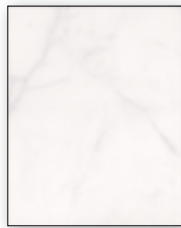
weiß, glänzend, eben
blanc, brillant, lisse
white, glossy, smooth

538260-400

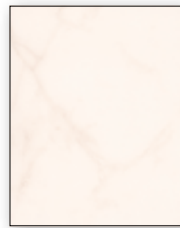
hellgrau, marmoriert, glänzend, eben
gris, clair marbré, brillant, lisse
pale, grey marbled, glossy, smooth

538280-400

beige, marmoriert, glänzend, eben
beige, clair marbré, brillant, lisse
beige, grey marbled, glossy, smooth

538021-400

weiß, matt, eben
blanc, mat, lisse
white, matt, smooth

538261-400

hellgrau, marmoriert, matt, eben
gris clair, marbré, mat, lisse
pale grey, marbled, matt, smooth

538281-400

beige, marmoriert, matt, eben
beige, clair marbré, mat, lisse
beige, grey marbled, matt, smooth

20 x 60 cm

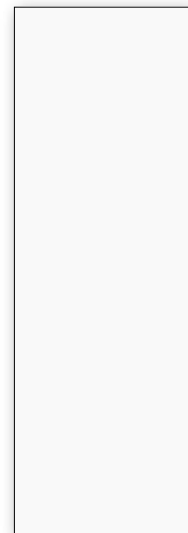

381474

weiß, glänzend, eben
blanc, brillant, lisse
white, glossy, smooth

20 x 40 cm

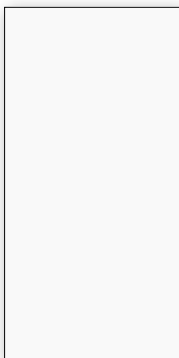

182763

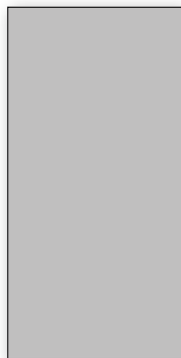
weiß, glänzend, eben
blanc, brillant, lisse
white, glossy, smooth

183343

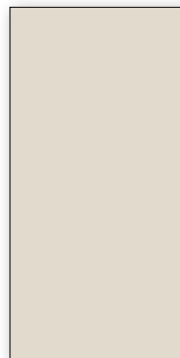
hellgrau, matt, eben
gris clair, mat, lisse
light-grey, matt, smooth

183344

hellbeige, matt, eben
beige clair, mat, lisse
light-beige, matt, smooth

381475

weiß, matt, eben
blanc, mat, lisse
white, matt, smooth

182764

weiß, matt, eben
blanc, mat, lisse
white, matt, smooth

BASIS 1

Art.	Nennmaß cote nominale nominal size cm	Herstellmaß cote de fabrication production size mm	m ²	Paket carton box	Palette palette pallet	Beanspr.-Gruppe groupe d'emploi wear resist. group	Norm Norme Standard	Trittsicherheit antidérapance non-slip	Preisgruppe groupe de prix price category
239996							BIII GL	A31 (m ²)	
239995							BIII GL	A31 (m ²)	
239998	25 x 33	249 x 330 x 8,0	12,121 St pc	13 St pc	80,439 m ²		BIII GL	A31 (m ²)	
239997			12,969 kg	1,073 m ² 13,910 kg	1.043,250 kg		BIII GL	A31 (m ²)	
231032							BIII GL	A31 (m ²)	
231034							BIII GL	A31 (m ²)	
269478	25 x 44	249 x 441 x 9,0	9,000 St pc	10 St pc	63,333 m ²		BIII GL	A40 (m ²)	
269479			15,498 kg	1,111 m ² 17,220 kg	981,540 kg		BIII GL	A40 (m ²)	

Wandfliese | carreau de mur | wall tile

Steingut glasiert | faïence émaillée | earthenware glazed

25 x 33 cm

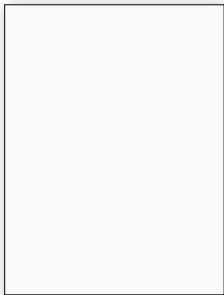

239996

weiß, glänzend, eben
blanc, brillant, lisse
white, glossy, smooth

239995

weiß, matt, eben
blanc, mat, lisse
white, matt, smooth

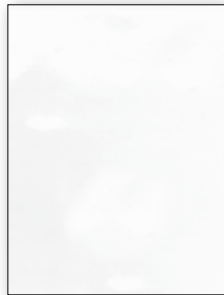

239998

weiß, glänzend, gewellt, eben
blanc, brillant, ondulé, lisse
white, glossy, undulated, smooth

239997

weiß, matt, gewellt, eben
blanc, mat, ondulé, lisse
white, matt, undulated, smooth

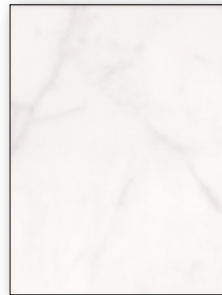

231032

hellgrau, marmoriert, glänzend, eben
gris, clair marbré, brillant, lisse
pale, grey marbled, glossy, smooth

231034

hellgrau, marmoriert, matt, eben
gris clair, marbré, mat, lisse
pale grey, marbled, matt, smooth

25 x 44 cm

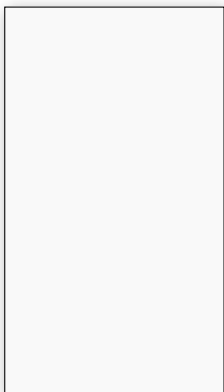

269478

weiß, glänzend, eben
blanc, brillant, lisse
white, glossy, smooth

269479

weiß, matt, eben
blanc, mat, lisse
white, matt, smooth

Art.	Nennmaß cote nominale nominal size cm	Herstellmaß cote de fabrication production size mm	m ²	Paket carton box	Palette palette pallet	Beanspr.-Gruppe groupe d'emploi wear resist. group	Norm Norme Standard	Trittsicherheit antidérapance non-slip	Preisgruppe groupe de prix price category
229480							BIII GL	A55 (m ²)	
229481	30 x 45	298 x 448 x 9,0	7,407 St pc	9 St pc	72,904 m ²		BIII GL	A55 (m ²)	
229482			15,000 kg	1,215 m ² 18,225 kg	1.093,500 kg		BIII GL	A55 (m ²)	
229483							BIII GL	A55 (m ²)	
282115R-02	30 x 60	297 x 597 x 9,0	5,556 St pc	9 St pc	77,754 m ²		BIII GL	A94 (m ²)	
282116R-02			14,890 kg	1,620 m ² 24,120 kg	1.157,760 kg		BIII GL	A94 (m ²)	
280374							BIII GL	A81 (m ²)	
280375							BIII GL	A81 (m ²)	
280718	30 x 60	297 x 597 x 9,0	5,556 St pc	9 St pc	77,754 m ²		BIII GL	A81 (m ²)	
280719			14,946 kg	1,620 m ² 24,210 kg	1.162,080 kg		BIII GL	A81 (m ²)	
280871							BIII GL	A67 (m ²)	
280872							BIII GL	A67 (m ²)	
283345							BIII GL	A110 (m ²)	
283346							BIII GL	A110 (m ²)	
203264	30 x 60	297 x 597 x 6,0	5,556 St pc	13 St pc	112,311 m ²		BIII GL	A81 (m ²)	
203265			10,279 kg	2,339 m ² 24,050 kg	1.154,444 kg		BIII GL	A81 (m ²)	

Wandfliese | carreau de mur | wall tile

Steingut glasiert | faïence émaillée | earthenware glazed

30 x 45 cm

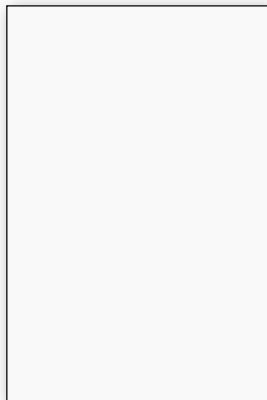
**229480**

weiß, glänzend, eben
blanc, brillant, lisse
white, glossy, smooth

229481

weiß, matt, eben
blanc, mat, lisse
white, matt, smooth

229482

weiß, glänzend, gewellt, eben
blanc, brillant, ondulé, lisse
white, glossy, undulated, smooth

229483

weiß, matt, gewellt, eben
blanc, mat, ondulé, lisse
white, matt, undulated, smooth

30 x 60 cm

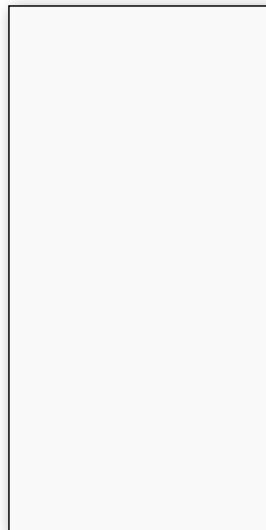
**280374**

weiß, glänzend, eben
blanc, brillant, lisse
white, glossy, smooth

280375

weiß, matt, eben
blanc, mat, lisse
white, matt, smooth

280718

weiß, glänzend, gewellt, eben
blanc, brillant, ondulé, lisse
white, glossy, undulated, smooth

280719

weiß, matt, gewellt, eben
blanc, mat, ondulé, lisse
white, matt, undulated, smooth

280871

sandbeige, glänzend, eben
beige sable, brillant, lisse
sand-beige, glossy, smooth

280872

sandbeige, matt, eben
beige sable, mat, lisse
sand-beige, matt, smooth

**203264**

weiß, glänzend, eben
blanc, brillant, lisse
white, glossy, smooth

**203265**

weiß, matt, eben
blanc, mat, lisse
white, matt, smooth

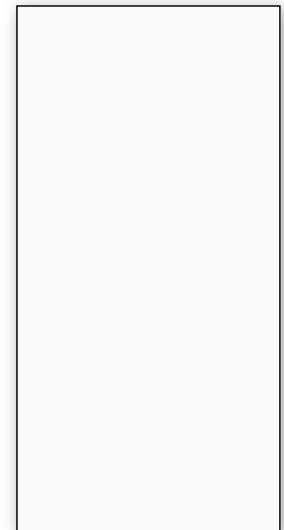
**282115R-02**

weiß, glänzend, eben
blanc, brillant, lisse
white, glossy, smooth

**282116R-02**

weiß, matt, eben
blanc, mat, lisse
white, matt, smooth

283345

hellgrau, matt, eben
gris clair, mat, lisse
light-grey, matt, smooth

283346

hellbeige, matt, eben
beige clair, mat, lisse
light-beige, matt, smooth

BASIS 1

Art.	Nennmaß cote nominale nominal size cm	Herstellmaß cote de fabrication production size mm	m ² /m	Paket carton box	Palette palette pallet	Beanspr.-Gruppe groupe d'emploi wear resist. group	Norm Norme Standard	Trittsicherheit antidérapance non-slip	Preisgruppe groupe de prix price category
323260	30 x 90	297 x 897 x 6,0	3,704 St pc	8 St pc	51,836 m ²		BIII GL		A101 (m ²)
323261			10,400 kg	2,160 m ² 22,464 kg	539,094 kg		BIII GL		A101 (m ²)
391589	30 x 90	297 x 897 x 10,5	3,704 St pc	5 St pc	32,397 m ²		BIII GL		A101 (m ²)
391590			17,976 kg	1,350 m ² 24,265 kg	582,360 kg		BIII GL		A101 (m ²)
363335	35 x 100	347 x 997 x 6,0	2,857 St pc	5 St pc	70,000 m ²		BIII GL		A119 (m ²)
363336			10,513 kg	1,750 m ² 18,400 kg	736,000 kg		BIII GL		A119 (m ²)
533436-198	1 x 20	10 x 197 x 6,0	5,000 St pc	100 St pc			BIII GL		A414 (St pc)
			0,125 kg	20,000 m 2,500 kg			BIII GL		
533434-198	4,5 x 20	45 x 197 x 6,0	5,000 St pc	72 St pc			BIII GL		A431 (St pc)
			0,505 kg	14,400 m 7,272 kg			BIII GL		

Wandfliese | carreau de mur | wall tile

Steingut glasiert | faïence émaillée | earthenware glazed

30 x 90 cm

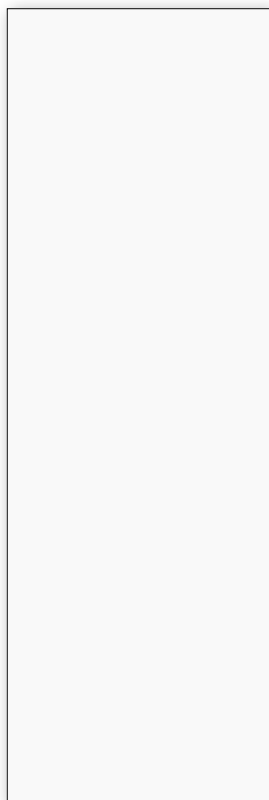

323260



weiß, glänzend, eben
blanc, brillant, lisse
white, glossy, smooth

323261



weiß, matt, eben
blanc, mat, lisse
white, matt, smooth

391589

weiß, glänzend, eben
blanc, brillant, lisse
white, glossy, smooth

391590

weiß, matt, eben
blanc, mat, lisse
white, matt, smooth^o

35 x 100 cm

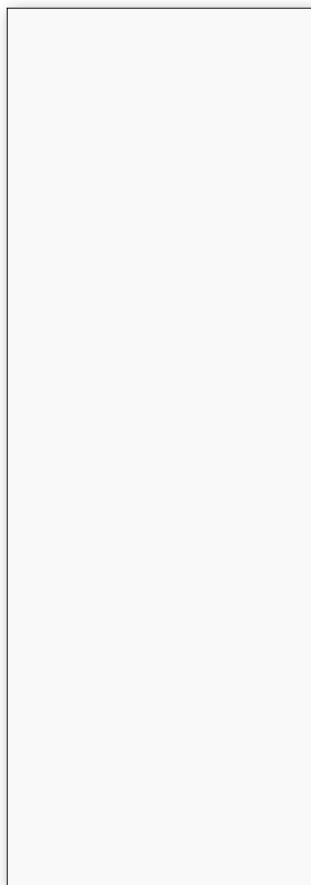

363335



weiß, glänzend, eben
blanc, brillant, lisse
white, glossy, smooth

363336



weiß, matt, eben
blanc, mat, lisse
white, matt, smooth

Listel Candy

Steingut glasiert | faïence émaillée | earthenware glazed

1 x 20 cm



533436-198

candy
seidenmatt | satiné | silky-matt

4,5 x 20 cm



533434-198

candy
seidenmatt | satiné | silky-matt





3D Rendering / Serie · série · series: Cedra



Von Holz inspiriert

Mit ihrer dezenten Erinnerung an Holzoberflächen ist Cedra die perfekte Wahl für eine wohnliche Badgestaltung. Die beiden Wandfliesenfarben in zwei Formaten lassen sich gut mit den Bordüren kombinieren. Diese Bordüren, die mit und ohne Einleger aus Feinsteinzeug verfügbar sind, setzen optische Akzente. Sie greifen die drei klassischen Farben des Bodens auf. Besonders praktisch: Neben den drei Bodenformaten kann man den Duschboden mit einem passenden Mosaik in R10/B fortführen. Die Wandfliesen sind durch ihre Hytect-Oberfläche besonders reinigungsfreundlich.

Inspiré par le bois

Avec sa réminiscence subtile des surfaces en bois, Cedra est le choix idéal pour une salle de bains au design accueillant. Les deux couleurs de carreaux de mur en deux formats se combinent bien avec les bordures. Ces bordures, disponibles avec et sans cabochons en grès cérame fin vitrifié, mettent des accents visuels. Elles reprennent les trois couleurs classiques du sol. Particulièrement pratique : en plus des trois formats de sol, le sol de la douche peut être continué sous forme de mosaïque assortie en R10/B. Les carreaux de mur sont particulièrement faciles à nettoyer grâce à leur surface Hytect.

Inspired by wood

With its subtle reminiscence of wood surfaces, Cedra is the perfect choice for a homely bathroom design. The two wall tile colours in two formats can be harmoniously combined with the borders. These borders, which are available with and without porcelain stoneware inlays, set visual accents. They pick up the three classic colours of the floor. Particularly practical: in addition to the three floor formats, the shower floor can be continued with a matching mosaic in R10/B. The wall tiles are particularly easy to clean thanks to their Hytect surface.

Art.	Nennmaß cote nominale nominal size cm	Herstellmaß cote de fabrication production size mm	m ²	Paket carton box	Palette palette pallet	Beanspr.-Gruppe groupe d'emploi wear resist. group	Norm Norme Standard	Trittsicherheit antidérapance non-slip	Preisgruppe groupe de prix price category
281726	30 x 60	297 x 597 x 9	5,556 St pc	9 St pc	77,754 m ²		BIII GL		B69 (m ²)
281727			14,946 kg	1,620 m ² 24,210 kg	1.162,080 kg		BIII GL		B69 (m ²)
392720	30 x 90	297 x 897 x 10,5	3,704 St pc	5 St pc	32,397 m ²		BIII GL		B142 (m ²)
392721			17,976 kg	1,350 m ² 24,265 kg	582,360 kg		BIII GL		B142 (m ²)

Wandfliese | carreau de mur | wall tile
Steingut glasiert | faïence émaillée | earthenware glazed

30 x 60 cm

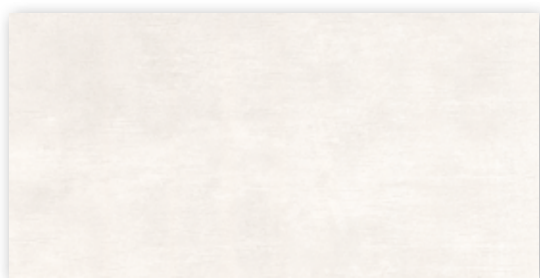

281726
weiß-creme | blanc crème | white-cream
seidenmatt, eben | satinée, lisse | silky-matt, smooth



281727
beige
seidenmatt, eben | satinée, lisse | silky-matt, smooth

30 x 90 cm

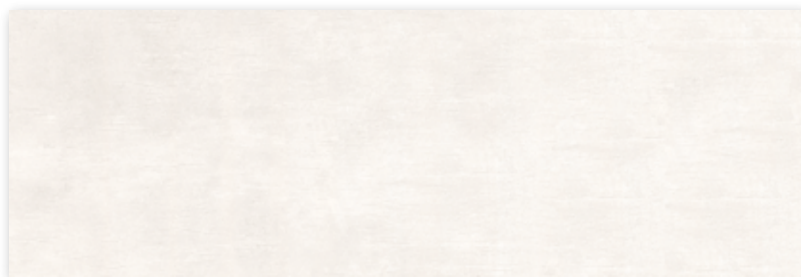

392720
weiß-creme | blanc crème | white-cream
seidenmatt, eben | satinée, lisse | silky-matt, smooth



392721
beige
seidenmatt, eben | satinée, lisse | silky-matt, smooth

Art.	Nennmaß cote nominale nominal size cm	Herstellmaß cote de fabrication production size mm	m	Paket carton box	Palette palette pallet	Beanspr.-Gruppe groupe d'emploi wear resist. group	Norm Norme Standard	Trittsicherheit antidérapance non-slip	Preisgruppe groupe de prix price category
281728							Bla UGL		B474 (St pc)
281730							Bla UGL		B474 (St pc)
281732	10 x 60	97 x 597 x 10,5	1,667 St pc	4 St pc			Bla UGL		B474 (St pc)
281729			2,167 kg	2,400 m	5,200 kg		Bla UGL		B466 (St pc)
281731							Bla UGL		B466 (St pc)
281733							Bla UGL		B466 (St pc)

Dekorationselemente | éléments décoratifs | decoration elements

Bordüre | Bordure | Border

Feinsteinzeugfliesen unglasiert | grès cérame fin vitrifié non-émaillés | porcelain stoneware tiles unglazed

10 x 60 cm

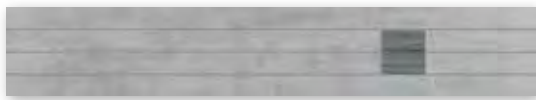

281728

grau | gris | grey
eben, matt | lisse, mat | smooth, matt
mit Feinsteinzeuginleger
avec cabochon en grès cérame fin vitrifié
with porcelain stoneware insert

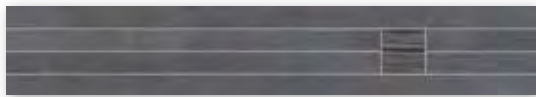

281730

anthrazit | anthracite
eben, matt | lisse, mat | smooth, matt
mit Feinsteinzeuginleger
avec cabochon en grès cérame fin vitrifié
with porcelain stoneware insert

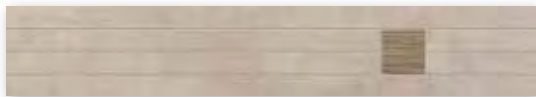

281732

schlamm | boue | mud-brown
eben, matt | lisse, mat | smooth, matt
mit Feinsteinzeuginleger
avec cabochon en grès cérame fin vitrifié
with porcelain stoneware insert



281729

grau | gris | grey
eben, matt | lisse, mat | smooth, matt

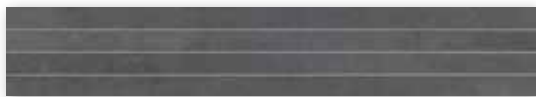

281731

anthrazit | anthracite
eben, matt | lisse, mat | smooth, matt

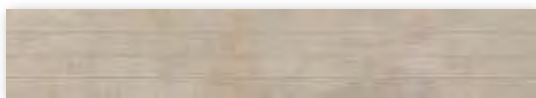

281733

schlamm | boue | mud-brown
eben, matt | lisse, mat | smooth, matt

Abgabe der Dekorationselemente ausschließlich in vollen Kartons.
Éléments décoratifs uniquement livrables en cartons entiers.
Decoration elements only available in full boxes.

Bordüre, Verklebung rückseitig auf Glasfasernetz,
Bogen: 97 x 597 mm

Bordure, collée sur trame en fibre de verre à
l'envers, Feuille : 97 x 597 mm

Border, glass fibre net on reverse side,
Sheet: 97 x 597 mm

Art.	Nennmaß cote nominale nominal size cm	Herstellmaß cote de fabrication production size mm	m	Paket carton box	Palette palette pallet	Beanspr.-Gruppe groupe d'emploi wear resist. group	Norm Norme Standard	Trittsicherheit antidérapance non-slip	Preisgruppe groupe de prix price category
392723							Bla UGL	B491 (St pc)	
392725							Bla UGL	B491 (St pc)	
392727	10 x 90	97 x 897 x 10,5	1,111 St pc	2 St pc			Bla UGL	B491 (St pc)	
392724			2,166 kg	1,800 m	3,900 kg		Bla UGL	B486 (St pc)	
392726							Bla UGL	B486 (St pc)	
392728							Bla UGL	B486 (St pc)	

Dekorationselemente | éléments décoratifs | decoration elements

Bordüre | Bordure | Border

Feinsteinzeugfliesen unglasiert | grès cérame fin vitrifié non-émaillés | porcelain stoneware tiles unglazed

10 x 90 cm



392723

grau | gris | grey
eben, matt | lisse, mat | smooth, matt
mit Feinsteinzeuginleger
avec cabochon en grès cérame fin vitrifié
with porcelain stoneware insert

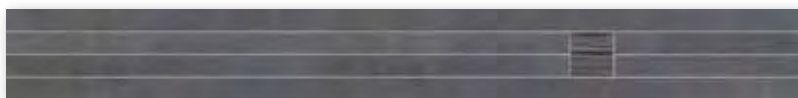

392725

anthrazit | anthracite
eben, matt | lisse, mat | smooth, matt
mit Feinsteinzeuginleger
avec cabochon en grès cérame fin vitrifié
with porcelain stoneware insert

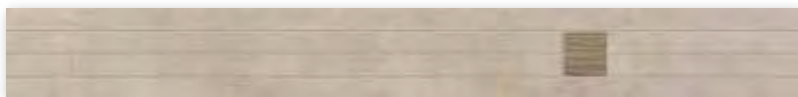

392727

schlamm | boue | mud-brown
eben, matt | lisse, mat | smooth, matt
mit Feinsteinzeuginleger
avec cabochon en grès cérame fin vitrifié
with porcelain stoneware insert



392724

grau | gris | grey
eben, matt | lisse, mat | smooth, matt



392726

anthrazit | anthracite
eben, matt | lisse, mat | smooth, matt



392728

schlamm | boue | mud-brown
eben, matt | lisse, mat | smooth, matt

Abgabe der Dekorationselemente ausschließlich in vollen Kartons.
Éléments décoratifs uniquement livrables en cartons entiers.
Decoration elements only available in full boxes.

Bordüre, Verklebung rückseitig auf Glasfasernetz,
Bogen: 97 x 897 mm

Bordure, collée sur trame en fibre de verre à
l'envers, Feuille : 97 x 897 mm

Border, glass fibre net on reverse side,
Sheet: 97 x 897 mm

Art.	Nennmaß cote nominale nominal size cm	Herstellmaß cote de fabrication production size mm	m ²	Paket carton box	Palette palette pallet	Beanspr.-Gruppe groupe d'emploi wear resist. group	Norm Norme Standard	Trittsicherheit antidérapance non-slip	Preisgruppe groupe de prix price category
433692							Bla UGL	R9	B112 (m ²)
433693	30 x 60	297 x 597 x 10,5	5,556 St pc	6 St pc	43,197 m ²		Bla UGL	R9	B112 (m ²)
433694			23,224 kg	1,080 m ² 25,080 kg	1.003,200 kg		Bla UGL	R9	B112 (m ²)
434757							Bla UGL	R9	B126 (m ²)
434758	60 x 60	597 x 597 x 10,5	2,778 St pc	3 St pc	38,877 m ²		Bla UGL	R9	B126 (m ²)
434759			23,769 kg	1,080 m ² 25,668 kg	924,048 kg		Bla UGL	R9	B126 (m ²)



anthrazit
anthracite



grau
gris
grey

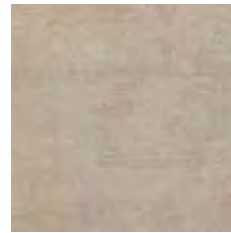

schlamm
boue
mud-brown



Bodenfliese | carreau de sol | floor tile

Feinsteinzeugfliesen unglasiert | grès cérame fin vitrifié non-émaillés | porcelain stoneware tiles unglazed

30 x 60 cm



433692

anthrazit | anthracite
eben, matt | lisse, mat | smooth, matt



433693

grau | gris | grey
eben, matt | lisse, mat | smooth, matt

433694

schlamm | boue | mud-brown
eben, matt | lisse, mat | smooth, matt

60 x 60 cm



434757

anthrazit | anthracite
eben, matt | lisse, mat | smooth, matt



434758

grau | gris | grey
eben, matt | lisse, mat | smooth, matt

434759

schlamm | boue | mud-brown
eben, matt | lisse, mat | smooth, matt

Art.	Nennmaß cote nominale nominal size cm	Herstellmaß cote de fabrication production size mm	m ²	Paket carton box	Palette palette pallet	Beanspr.-Gruppe groupe d'emploi wear resist. group	Norm Norme Standard	Trittsicherheit antidérapance non-slip	Preisgruppe groupe de prix price category
433737							Bla UGL	R9	B152 (m ²)
433738	45 x 90	447 x 897 x 10,5	2,470 St pc	2 St pc	32,389 m ²		Bla UGL	R9	B152 (m ²)
433739			23,070 kg	0,810 m ² 18,680 kg	747,200 kg		Bla UGL	R9	B152 (m ²)



anthrazit
anthracite
anthracite

V2



grau
gris
grey

V2



schlamm
lisse
mud-brown

V3

45 x 90 cm



433737

anthrazit | anthracite
eben, matt | lisse, mat | smooth, matt



433738

grau | gris | grey
eben, matt | lisse, mat | smooth, matt

433739

schlamm | boue | mud-brown
eben, matt | lisse, mat | smooth, matt

Achtung: Sonderpalette. Keine Rücknahme, kein Umtausch.
Attention : palette spéciale. Pas de retour, pas d'échange.
Please note: special pallet. No return, no exchange.

Art.	Nennmaß cote nominale nominal size cm	Herstellmaß cote de fabrication production size mm	m ² /m	Paket carton box	Palette palette pallet	Beanspr.-Gruppe groupe d'emploi wear resist. group	Norm Norme Standard	Trittsicherheit antidérapance non-slip	Preisgruppe groupe de prix price category
433695							Bla UGL		B440 (St pc)
433696	7 x 60	70 x 597 x 10,5	1,667 St pc / m	22 St pc			Bla UGL		B440 (St pc)
433697			1,584 kg	13,197 m	20,900 kg		Bla UGL		B440 (St pc)
433757							Bla UGL	R10/B	B284 (m ²)
433756	5 x 5	47 x 47 x 10,5	11,111 Bögen plaques sheets	11 Bögen plaques sheets	29,700 m ²		Bla UGL	R10/B	B284 (m ²)
433758			22,222 kg / m ²	0,990 m ²	22,000 kg	660,000 kg	Bla UGL	R10/B	B284 (m ²)

Sockel, gerundet | plinthe, arrondie | skirting, rounded

Feinsteinzeugfliesen unglasiert | grès cérame fin vitrifié non-émaillés | porcelain stoneware tiles unglazed

7 x 60 cm



433695

anthrazit | anthracite
eben, matt | lisse, mat | smooth, matt

433696

grau | gris | grey
eben, matt | lisse, mat | smooth, matt

433697

schlamm | boue | mud-brown
eben, matt | lisse, mat | smooth, matt

Mosaik | mosaïque | mosaic

Feinsteinzeugfliesen unglasiert | grès cérame fin vitrifié non-émaillés | porcelain stoneware tiles unglazed

5 x 5 cm



433757

anthrazit | anthracite
eben, matt | lisse, mat | smooth, matt

433756

grau | gris | grey
eben, matt | lisse, mat | smooth, matt

433758

schlamm | boue | mud-brown
eben, matt | lisse, mat | smooth, matt

Mosaik, Verklebung rückseitig auf Glasfasernetz,
Bogen: 297 x 297 mm

Mosaïque, collée sur trame en fibre de verre à
l'envers, Feuille : 297 x 297 mm

Mosaic, glass fibre net on reverse side,
Sheet: 297 x 297 mm

Weiches Farbspiel zwischen Beton und Sand

Schattig, wolkig, puristisch. Geschliffener Beton mit Einschlüssen von Sand und feiner Gesteinskörnung: das ist Como. Sinnbild für ein Material, das viele Freiheiten lässt für Eigenkreationen. Und doch so schlicht, dass es sich nahezu überall anpasst. Für ein stylisches Ambiente mit Loft-Charakter, schlichte Ästhetik oder pure Ursprünglichkeit. Für Akzente sorgen die Dekorelemente Script mit Farb- und Reliefdruck in den Farben der Wandfliesen oder die Bordüre Block in Graphitschwarz oder Sandbeige.

Jeu de couleurs doux entre le béton et le sable

Ombreux, nuageux, puriste. Como, c'est du béton poncé avec des inclusions de sable et une granularité de roche fine. Le symbole d'un matériau qui permet de grandes libertés pour des créations originales – et pourtant si simple qu'il s'adapte presque partout. Pour une ambiance stylisée à caractère de loft, une esthétique simple ou authentique pure. Les éléments décoratifs Script avec impression en couleur et en relief dans les coloris des carreaux de mur ou la bordure Block en noir graphite ou beige sable posent des accents.

Flowing play of colors between concrete and sand

Shadowy, cloudy, purist. Polished concrete with inclusions featuring sand and fine stone grains, Como is symbolic of a material which provides plenty of scope for individual creations. Yet so simple that it can be used practically anywhere. For a stylish ambience with a loft character, elegantly aesthetic or purely original. Highlights are provided by decorative elements such as Script, with color and relief print in the wall tile colors of glacier-white or natural beige as well as the border Block in graphite-black or sand-beige.





Studioaufnahme · photo prise en studio · studio photo / Architekt · architecte · architect: VSBL, Belgrad, Serbien · Belgrade, Serbie · Belgrade, Serbia /
Serie · série · series: Como / Photo: Jochen Stüber

Art.	Nennmaß cote nominale nominal size cm	Herstellmaß cote de fabrication production size mm	m ²	Paket carton box	Palette palette pallet	Beanspr.-Gruppe groupe d'emploi wear resist. group	Norm Norme Standard	Trittsicherheit antidérapance non-slip	Preisgruppe groupe de prix price category
282743H	30 x 60	297 x 597 x 9	5,556 St pc	9 St pc	77,754 m ²		BIII GL	W63 (m ²)	
282745H			14,946 kg	1,620 m ² 24,210 kg	1.162,080 kg		BIII GL	W63 (m ²)	
282749H	30 x 60	297 x 597 x 9	5,556 St pc	8 St pc			BIII GL	W91 (m ²)	
282751H			14,946 kg	1,440 m ² 21,520 kg			BIII GL	W91 (m ²)	

Wandfliese | carreau de mur | wall tile

Steingut glasiert | faïence émaillée | earthenware glazed

30 x 60 cm

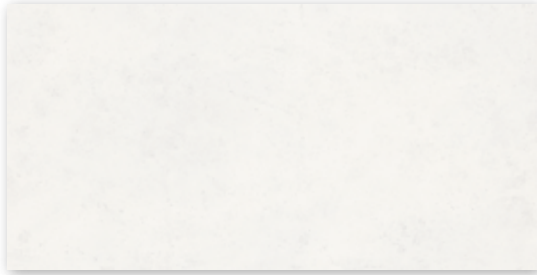

282743H

gletscherweiß | blanc glacier | glacier-white
seidenmatt, eben | satiné, lisse | silky-matt, smooth

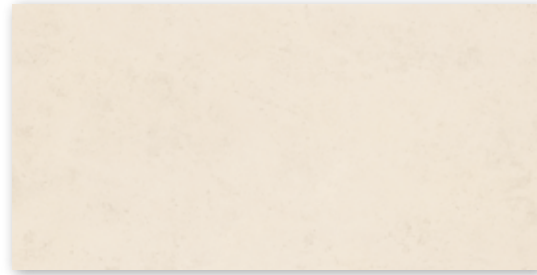

282745H

naturbeige | beige nature | natural beige
seidenmatt, eben | satiné, lisse | silky-matt, smooth



Dekorationselemente | éléments décoratifs | decoration elements

Dekorfliese Script | carreau décoratif Script | decorative element Script

Steingut glasiert | faïence émaillée | earthenware glazed

30 x 60 cm



282749H

gletscherweiß | blanc glacier | glacier-white
seidenmatt, eben | satiné, lisse | silky-matt, smooth



282751H

naturbeige | beige nature | natural beige
seidenmatt, eben | satiné, lisse | silky-matt, smooth



Abgabe der Dekorationselemente ausschließlich in vollen Kartons.
Éléments décoratifs uniquement livrables en cartons entiers.
Decoration elements only available in full boxes.

Art.	Nennmaß cote nominale nominal size cm	Herstellmaß cote de fabrication production size mm	m	Paket carton box	Palette palette pallet	Beanspr.-Gruppe groupe d'emploi wear resist. group	Norm Norme Standard	Trittsicherheit antidérapance non-slip	Preisgruppe groupe de prix price category
282746	4 x 60	40 x 597 x 10,5	1,667 St pc	3 St pc			Bla UGL	W448 (Set)	
282748			0,929 kg	1,800 m 1,671 kg			Bla UGL	W448 (Set)	

Dekorationselemente | éléments décoratifs | decoration elements

Bordüre Block | bordure Block | border Block

Feinsteinzeugfliesen unglasiert | grès cérame fin vitrifié non-émaillés | porcelain stoneware tiles unglazed

4 x 60 cm

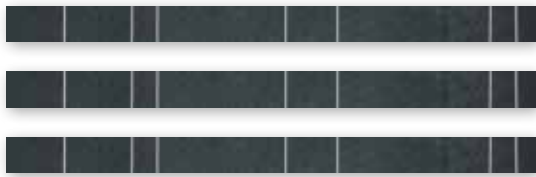

282746

graphitschwarz | noir graphite | graphite-black
eben, matt | lisse, mat | smooth, matt
3er-Set | jeu de 3 carreaux | set of 3 tiles

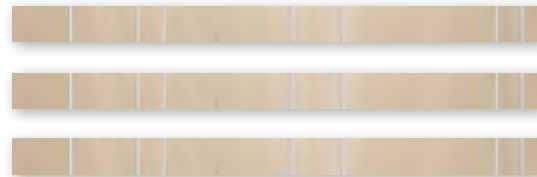

282748

sandbeige | beige sable | sand-beige
eben, matt | lisse, mat | smooth, matt
3er-Set | jeu de 3 carreaux | set of 3 tiles



Como Verlegebeispiele | Exemples de pose Como | Como laying examples

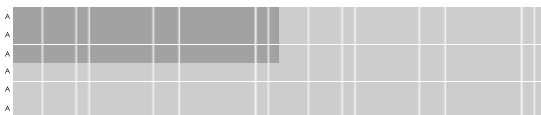

Abgabe der Dekorationselemente ausschließlich in vollen Kartons.
Éléments décoratifs uniquement livrables en cartons entiers.
Decoration elements only available in full boxes.



Studioaufnahme · photo prise en studio · studio photo / Serie · série · series: Concrete, Sierra



Harmonisches Wohngefühl

Die Serie Concrete schafft mit ihren Wandfliesen, in den Farben silbergrau und sandbeige ein natürliches und harmonisches Wohnambiente. Mit den Mosaikfliesen Screen und Stripes in graphit und sandbeige und den passenden Bordüren lassen sich stimmige Akzente setzen. Die Wandfliesen sind durch ihre Hytect-Oberfläche reinigungsfreundlich.

Un confort de vie harmonieux

Avec ses carreaux de mur en gris argenté et beige sable, la série Concrete crée une ambiance de vie naturelle et harmonieuse. Les carreaux de mosaïque Screen et Stripes en graphite et beige sable et les bordures assorties permettent de placer des accents de façon harmonieuse. Les carreaux de mur sont faciles à nettoyer grâce à leur surface Hytect.

Harmonious feeling of homeliness

With its wall tiles in the colors silver-grey and sand-beige, the series Concrete creates a natural and harmonious living ambience. Attractive accents can be set with the Screen and Stripes mosaic tiles in graphite and sand-beige and the matching borders. The wall tiles are easy to clean thanks to their Hytect surface.



CONCRETE

Art.	Nennmaß cote nominale nominal size cm	Herstellmaß cote de fabrication production size mm	m ² /m	Paket carton box	Palette palette pallet	Beanspr.-Gruppe groupe d'emploi wear resist. group	Norm Norme Standard	Trittsicherheit antidérapance non-slip	Preisgruppe groupe de prix price category
280345	30 x 60	296 x 595 x 9	5,556 St pc / m ²	9 St pc	77,754 m ²		BIII GL		W111 (m ²)
280354			14,946 kg	1,620 m ² 24,210 kg	1.162,080 kg		BIII GL		W111 (m ²)
280349-73	30 x 60	297 x 597 x 10,5	1,667 St pc / m	2 St pc	77,754 m ²		Bla UGL		W488 (St pc)
			6,668 kg	1,200 m 8,000 kg	1.162,080 kg		Bla UGL		
280360	30 x 60	296 x 595 x 10	1,667 St pc / m	2 St pc	77,754 m ²		Bla UGL		W488 (St pc)
			6,668 kg	1,200 m 8,000 kg	1.162,080 kg		Bla UGL		

Wandfliese | carreau de mur | wall tile

Steingut glasiert | faïence émaillée | earthenware glazed

30 x 60 cm



280345

silbergrau | gris argenté | silver-grey
seidenmatt, strukturiert | satiné, structuré | silky-matt, structured



280354

sandbeige | beige sable | sand-beige
seidenmatt, strukturiert | satiné, structuré | silky-matt, structured



Dekorationselemente | éléments décoratifs | decoration elements

Mosaikfliese | carreau à mosaïques | mosaic tile

Feinsteinzeugfliesen unglasiert | grès cérame fin vitrifié non-émaillés | porcelain stoneware tiles unglazed

30 x 60 cm



280349-73

Stripes
anthrazit | anthracite
strukturiert, matt | structuré, mat | structured, matt



280360

Stripes
sandbeige | beige sable | sand-beige
strukturiert, matt | structuré, mat | structured, matt



Farbabweichung zum Standard.
Les couleurs représentées peuvent différer du standard.
Colour deviation from the standard.

Abgabe der Dekorationselemente ausschließlich in vollen Kartons.
Éléments décoratifs uniquement livrables en cartons entiers.
Decoration elements only available in full boxes.

Art.	Nennmaß cote nominale nominal size cm	Herstellmaß cote de fabrication production size mm	m	Paket carton box	Palette palette pallet	Beanspr.-Gruppe groupe d'emploi wear resist. group	Norm Norme Standard	Trittsicherheit antidérapance non-slip	Preisgruppe groupe de prix price category
280351-73	30 x 60	297 x 597 x 10,5	1,667 St pc 6,668 kg	2 St pc 1,200 m 8,000 kg			Bla UGL Bla UGL	W490 (St pc)	
280362	30 x 60	296 x 595 x 10	1,667 St pc 6,668 kg	2 St pc 1,200 m 8,000 kg			Bla UGL Bla UGL	W490 (St pc)	

Dekorationselemente | éléments décoratifs | decoration elements

Mosaikfliese | carreau à mosaïques | mosaic tile

Feinsteinzeugfliesen unglasiert | grès cérame fin vitrifié non-émaillés | porcelain stoneware tiles unglazed

30 x 60 cm

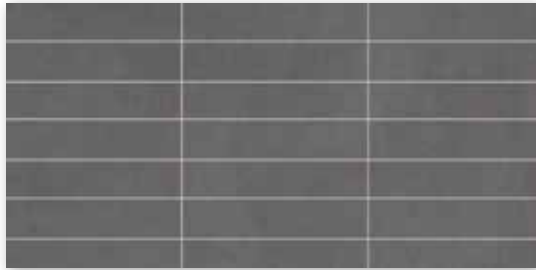

280351-73

Screen
anthrazit | anthracite
strukturiert, matt | structuré, mat | structured, matt



280362

Screen
sandbeige | beige sable | sand-beige
strukturiert, matt | structuré, mat | structured, matt



Farbabweichung zum Standard.
Les couleurs représentées peuvent différer du standard.
Colour deviation from the standard.

Abgabe der Dekorationselemente ausschließlich in vollen Kartons.
Éléments décoratifs uniquement livrables en cartons entiers.
Decoration elements only available in full boxes.

CONCRETE

Art.	Nennmaß cote nominale nominal size cm	Herstellmaß cote de fabrication production size mm	m	Paket carton box	Palette palette pallet	Beanspr.-Gruppe groupe d'emploi wear resist. group	Norm Norme Standard	Trittsicherheit antidérapance non-slip	Preisgruppe groupe de prix price category
280350-73	8 x 60	80 x 597 x 10,5	1,667 St pc 1,779 kg	4 St pc 2,400 m 4,268 kg			Bla UGL Bla UGL	W448 (St pc)	
280361	8 x 60	80 x 595 x 10	1,667 St pc 1,779 kg	4 St pc 2,400 m 4,268 kg			Bla UGL Bla UGL	W448 (St pc)	

Dekorationselemente | éléments décoratifs | decoration elements

Bordüre | bordure | border

Feinsteinzeugfliesen unglasiert | grès cérame fin vitrifié non-émaillés | porcelain stoneware tiles unglazed

8 x 60 cm



280350-73

Stripes
anthrazit | anthracite
strukturiert, matt | structuré, mat | structured, matt

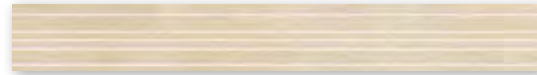

280361

Stripes
sandbeige | beige sable | sand-beige
strukturiert, matt | structuré, mat | structured, matt



Farbabweichung zum Standard.
Les couleurs représentées peuvent différer du standard.
Colour deviation from the standard.

Abgabe der Dekorationselemente ausschließlich in vollen Kartons.
Éléments décoratifs uniquement livrables en cartons entiers.
Decoration elements only available in full boxes.



Luxuriös und harmonisch

Ob in Kombination mit Naturmaterialien, Pastellfarben oder Metall: Evalia passt sich individuellen Wohnideen an und bringt eine geschmackvolle, luxuriöse Note ein. Zu den großformatigen R9-Bodenfliesen in Grau, Beige und Anthrazit harmonisieren die Wandfliesen in Graubeige matt oder glänzend. Ebenfalls in Graubeige: das Dekor Shino im Format 30 x 60 cm und das R10/B-Mosaik im Format 5 x 5 cm, die im gleichen Look & Feel der Serie für Dynamik in der Gestaltung sorgen. Wandfliesen, Dekor und Mosaik sind durch die Hytect-Oberfläche reinigungsfreundlich. Sockel runden das Fliesenprogramm ab.

Luxueux et harmonieux

Combiné facilement et libère des matériaux naturels, des couleurs pastel ou des métaux, Evalia s'adapte à toutes vos idées d'aménagement et leur apporte une touche de luxe raffiné. Les carreaux de sol R9 en 60 x 60 ou en 45 x 90 cm sont disponibles en gris, beige, et anthracite. Ils sont assortis aux carreaux muraux gris-beige mat ou brillant, format 30 x 60 cm et 30 x 90 cm. Également disponible en gris-beige : le décor Shino au format 30 x 60 cm et la mosaïque R10/B au format 5 x 5 cm, qui reprennent l'esprit de la série et permettent d'ajouter du dynamisme à votre agencement. Les carreaux muraux, décoratifs et mosaïques sont dotés de la finition Hytect, facile à nettoyer. Des plinthes viennent compléter cette gamme de carreaux.

Luxurious and harmonious

Whether in combination with natural materials, pastel colors or metal: Evalia adapts to individual home ideas and adds a tasteful, luxurious touch. The large-format R9 floor tiles in grey, beige and anthracite harmonise with the wall tiles in grey beige matt or gloss. Likewise in grey-beige: the Shino decorative element measuring 30 x 60 cm and R10/B mosaic in 5 x 5 cm whose similar look and feel inject some dynamism into the design. Wall tiles, decorations and mosaics are easy to clean thanks to the Hytect surface. This range of tiles is rounded off by skirtings.





Art.	Nennmaß cote nominale nominal size cm	Herstellmaß cote de fabrication production size mm	m ²	Paket carton box	Palette palette pallet	Beanspr.-Gruppe groupe d'emploi wear resist. group	Norm Norme Standard	Trittsicherheit antidérapance non-slip	Preisgruppe groupe de prix price category
283102HR	30 x 60	297 x 597 x 9	5,556 St pc	9 St pc	77,754 m ²		BIII GL		B82 (m ²)
283126HR			14,946 kg	1,620 m ² 24,210 kg	1.162,080 kg		BIII GL		B82 (m ²)
393104H	30 x 90	297 x 897 x 10,5	3,704 St pc	5 St pc	32,397 m ²		BIII GL		B142 (m ²)
393127H			17,976 kg	1,350 m ² 24,265 kg	582,360 kg		BIII GL		B142 (m ²)

Wandfliese | carreau de mur | wall tile

Steingut glasiert | faïence émaillée | earthenware glazed

30 x 60 cm

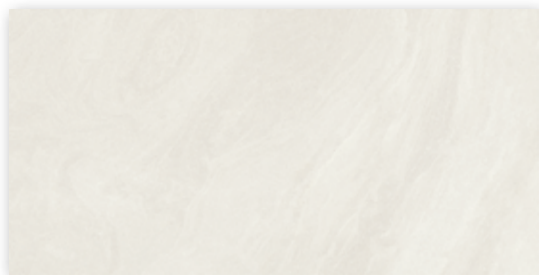

283102HR

graubeige | gris beige | grey beige
glänzend, eben | brillant, lisse | glossy, smooth

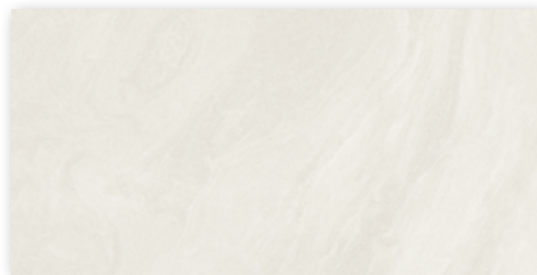

283126HR

graubeige | gris beige | grey beige
seidenmatt, eben | satinée, lisse | silky-matt, smooth



30 x 90 cm

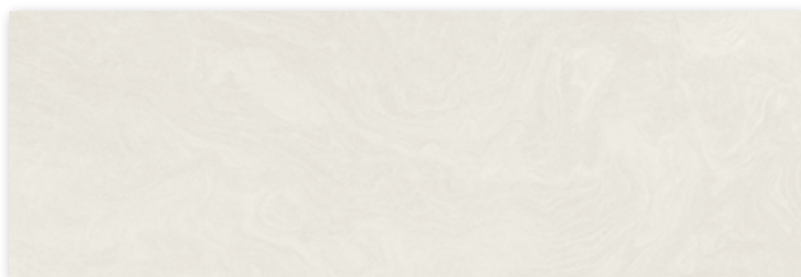

393104H

graubeige | gris beige | grey beige
glänzend, eben | brillant, lisse | glossy, smooth

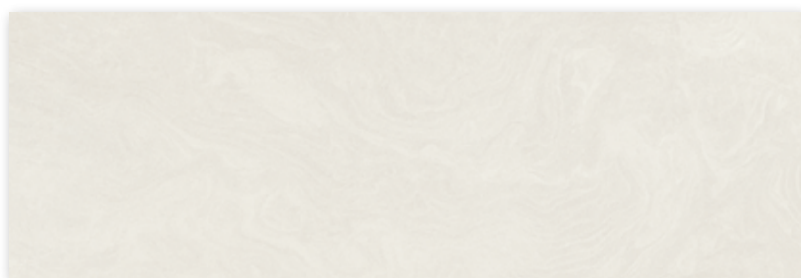

393127H

graubeige | gris beige | grey beige
seidenmatt, eben | satinée, lisse | silky-matt, smooth



Art.	Nennmaß cote nominale nominal size cm	Herstellmaß cote de fabrication production size mm	m ²	Paket carton box	Palette palette pallet	Beanspr.-Gruppe groupe d'emploi wear resist. group	Norm Norme Standard	Trittsicherheit antidérapance non-slip	Preisgruppe groupe de prix price category
283103HR	30 x 60	297 x 597 x 9	5,556 St pc 14,946 kg	9 St pc 1,620 m ² 24,210 kg	77,754 m ² 1.162,080 kg		BIII GL		B82 (m ²)

Dekorationselemente | éléments décoratifs | decoration elements

Dekorfliese Shino | carreau décoratif Shino | decorative element Shino

Steingut glasiert | faïence émaillée | earthenware glazed

30 x 60 cm



283103HR

graubeige | gris beige | grey beige
glänzend, eben | brillant, lisse | glossy, smooth

Farbunterschiede sind möglich und Bestandteil des Designs. Bei der von Ihnen ausgewählten Dekoration handelt es sich um ein hochwertiges Produkt aus Steingut glasiert, das mit einer besonders realistischen Steinoptik überzeugt. Die Dekoration besteht aus unterschiedlichen Einzelbildern. Die Anschlüsse der Einzelbilder sind bewusst frei gestaltet, und verbinden sich somit nicht in der fortlaufenden Verlegung.

Les différences de teintes sont possibles et font partie du motif. L'élément de décoration que vous avez choisi est un produit en faïence émaillée de grande qualité qui convainc par un visuel de pierre particulièrement réaliste. Ce décor se compose de motifs individuels différents. Les raccords entre ces motifs individuels sont conçus librement et non pour être raccordés en une pose continue.

Color deviations are possible and represent a component of the design. The decoration you have chosen is a high-quality glazed earthenware product with a particularly impressive and realistic stone look. The decoration comprises various individual pictures, whose connections are consciously freely designed. Accordingly, individual tiles do not create a continuous design.

Abgabe der Dekorationselemente ausschließlich in vollen Kartons.
Éléments décoratifs uniquement livrables en cartons entiers.
Decoration elements only available in full boxes.

Art.	Nennmaß cote nominale nominal size cm	Herstellmaß cote de fabrication production size mm	m ²	Paket carton box	Palette palette pallet	Beanspr.-Gruppe groupe d'emploi wear resist. group	Norm Norme Standard	Trittsicherheit antidérapance non-slip	Preisgruppe groupe de prix price category
393105H	30 x 90	297 x 897 x 10,5	3,704 St pc 17,976 kg	5 St pc 1,350 m ² 24,265 kg	32,397 m ² 582,360 kg		BIII GL		B142 (m²)

Dekorationselemente | éléments décoratifs | decoration elements

Dekorfliese Shino | carreau décoratif Shino | decorative element Shino

Steingut glasiert | faïence émaillée | earthenware glazed

30 x 90 cm



393105H

graubeige | gris beige | grey beige
glänzend, eben | brillant, lisse | glossy, smooth

Farbunterschiede sind möglich und Bestandteil des Designs. Bei der von Ihnen ausgewählten Dekoration handelt es sich um ein hochwertiges Produkt aus Steingut glasiert, das mit einer besonders realistischen Steinoptik überzeugt. Die Dekoration besteht aus unterschiedlichen Einzelbildern. Die Anschlüsse der Einzelbilder sind bewusst frei gestaltet, und verbinden sich somit nicht in der fortlaufenden Verlegung.

Les différences de teintes sont possibles et font partie du motif. L'élément de décoration que vous avez choisi est un produit en faïence émaillée de grande qualité qui convainc par un visuel de pierre particulièrement réaliste. Ce décor se compose de motifs individuels différents. Les raccords entre Ces motifs individuels sont conçus librement et non pour être raccordés en une pose continue.

Color deviations are possible and represent a component of the design. The decoration you have chosen is a high-quality glazed earthenware product with a particularly impressive and realistic stone look. The decoration comprises various individual pictures, whose connections are consciously freely designed. Accordingly, individual tiles do not create a continuous design.

Abgabe der Dekorationselemente ausschließlich in vollen Kartons.
Éléments décoratifs uniquement livrables en cartons entiers.
Decoration elements only available in full boxes.

Art.	Nennmaß cote nominale nominal size cm	Herstellmaß cote de fabrication production size mm	m ²	Paket carton box	Palette palette pallet	Beanspr.-Gruppe groupe d'emploi wear resist. group	Norm Norme Standard	Trittsicherheit antidérapance non-slip	Preisgruppe groupe de prix price category
431913							Bla UGL	R9	B138 (m ²)
431914	60 x 60	595 x 595 x 10	2,778 St pc	4 St pc	46,076 m ²		Bla UGL	R9	B138 (m ²)
431915			22,224 kg	1,440 m ² 32,000 kg	1.024,000 kg		Bla UGL	R9	B138 (m ²)
431916							Bla UGL	R9	B158 (m ²)
431917	45 x 90	446 x 895 x 10	2,470 St pc	3 St pc	36,437 m ²		Bla UGL	R9	B158 (m ²)
431918			24,700 kg	1,215 m ² 30,000 kg	900,000 kg		Bla UGL	R9	B158 (m ²)



grau
gris
grey



beige



anthrazit
anthracite



Bodenfliese | carreau de sol | floor tile

Feinsteinzeugfliesen unglasiert | grès cérame fin vitrifié non-émaillés | porcelain stoneware tiles unglazed

60 x 60 cm



431913

grau | gris | grey
eben, lappato | lisse, semi-poli | smooth, semi-polished

431914

beige
eben, lappato | lisse, semi-poli | smooth, semi-polished

431915

anthrazit | anthracite
eben, lappato | lisse, semi-poli | smooth, semi-polished

45 x 90 cm *



431916

grau | gris | grey
eben, lappato | lisse, semi-poli | smooth, semi-polished

431917

beige
eben, lappato | lisse, semi-poli | smooth, semi-polished

431918

anthrazit | anthracite
eben, lappato | lisse, semi-poli | smooth, semi-polished

* Achtung: Sonderpalette. Keine Rücknahme, kein Umtausch.

* Attention : palette spéciale. Pas de retour, pas d'échange.

* Please note: special pallet. No return, no exchange.

Art.	Nennmaß cote nominale nominal size cm	Herstellmaß cote de fabrication production size mm	m ² /m	Paket carton box	Palette palette pallet	Beanspr.-Gruppe groupe d'emploi wear resist. group	Norm Norme Standard	Trittsicherheit antidérapance non-slip	Preisgruppe groupe de prix price category
431920							Bla UGL	B440 (St pc)	
431921	7 x 60	70 x 595 x 10	1,667 St pc / m	15 St pc			Bla UGL	B440 (St pc)	
431922			1,547 kg	8,998 m	13,920 kg		Bla UGL	B440 (St pc)	
431919H	5 x 5	47 x 47 x 6,5	11 Bögen plaques sheets 12,331 kg / m ²	11 Bögen plaques sheets 1,000 m ²	12,331 kg 789,184 kg	64,000 m ²	Bla UGL	R10/B B152 (m ²)	



grau
gris
grey



beige

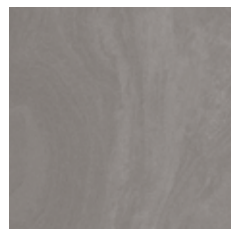

anthrazit
anthracite



Sockel, gerundet | plinthe, arrondie | skirting, rounded

Feinsteinzeugfliesen unglasiert | grès cérame fin vitrifié non-émaillés | porcelain stoneware tiles unglazed

7 x 60 cm



431920

grau | gris | grey
eben, lappato | lisse, semi-poli | smooth, semi-polishe

431921

beige
eben, lappato | lisse, semi-poli | smooth, semi-polishe

431922

anthrazit | anthracite
eben, lappato | lisse, semi-poli | smooth, semi-polishe

Mosaik | mosaïque | mosaic

Feinsteinzeugfliesen unglasiert | grès cérame fin vitrifié non-émaillés | porcelain stoneware tiles unglazed

5 x 5 cm



431919H

Shino
graubeige | gris beige | grey beige
eben, lappato | lisse, semi-poli | smooth, semi-polishe

Mosaik, rückseitig thermoplastisch verklebt

Bogen: 297 x 297 mm

Mosaïque, collage thermoplastique sur l'envers

Feuille: 297 x 297 mm

Mosaic, glued thermo-plastically on back

Sheet: 297 x 297 mm





Studioaufnahme · photo prise en studio · studio photo / Architekt · architecte · architect: Ákos Schreck, minusplus, Budapest, Ungarn · Hongrie · Hungary /
Serie · série · series: Focus Royal / Photo: Christian R. Schulz



Dezenter Luxus – kultiviertes Wohnen

Die gestreiften Wandfliesen in 30 x 60 cm oder 30 x 90 cm und die Dekorfliese Step in 30 x 90 cm, die die zarten Streifen der Wandfliese ausdrucksstärker aufgreift, vermitteln stilvolle Eleganz. Diese beiden Fliesen für die Wandgestaltung werden harmonisch ergänzt durch ein Mosaikdekor, geschnitten aus den Feinsteinzeug-Bodenfliesen und mit abwechselnd polierten und unpolierten Elementen. Erhältlich in den Farben Anthrazit-Schwarz, Hellbeige oder Mittelbraun.

Un luxe décent pour un intérieur raffiné

Les carreaux de mur subtilement rayés de format 30 x 60 cm et 30 x 90 et l'élément de décor Step de 30 x 90 cm qui reprend, en les intensifiant, les fines rayures du carreau de mur, laissent une impression d'élégance raffinée. L'élément de décor en mosaïque, découpé dans les carreaux de sol en gré cérame et alternant les surfaces polies et dépolies vient harmonieusement compléter les deux carreaux de mur. Couleurs disponibles : anthracite-noir, beige clair et brun moyen.

Discreet luxury for a stylish interior

Stylish elegance is conveyed by the striped wall tiles in 30 x 60 cm or 30 x 90 cm and the Step decorative tile in 30 x 90 cm which picks up on the delicate stripes of the wall tile in a more expressive manner. Both of these tiles for wall design are harmoniously supplemented by a mosaic décor cut from the porcelain stoneware floor tiles and featuring alternating polished and unpolished elements. Available in anthracite-black, light-beige or mid-brown.



Art.	Nennmaß cote nominale nominal size cm	Herstellmaß cote de fabrication production size mm	m ²	Paket carton box	Palette palette pallet	Beanspr.-Gruppe groupe d'emploi wear resist. group	Norm Norme Standard	Trittsicherheit antidérapance non-slip	Preisgruppe groupe de prix price category
280874H							BIII GL		W102 (m²)
281140H	30 x 60	297 x 597 x 9	5,556 St pc	9 St pc	77,754 m ²		BIII GL		W102 (m²)
282730H			14,946 kg	1,620 m ² 24,210 kg	1.162,080 kg		BIII GL		W102 (m²)
392735H							BIII GL		W130 (m²)
392736H	30 x 90	297 x 897 x 10,5	3,704 St pc	5 St pc	32,397 m ²		BIII GL		W130 (m²)
392738H			17,976 kg	1,350 m ² 24,265 kg	582,360 kg		BIII GL		W143 (m²)

Wandfliese | carreau de mur | wall tile

Steingut glasiert | faïence émaillée | earthenware glazed

30 x 60 cm

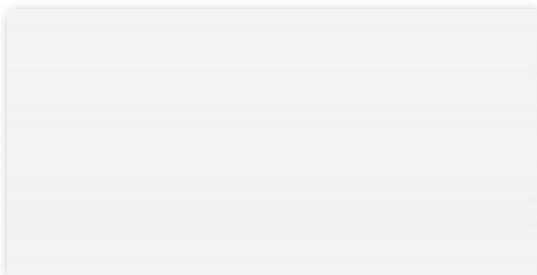

280874H

weiß | blanc | white
glänzend, eben | brillant, lisse | glossy, smooth

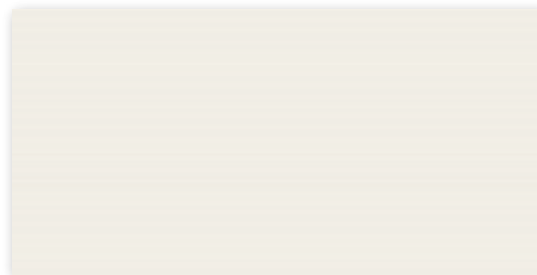

282730H

champagner | champagne | champagne
glänzend, eben | brillant, lisse | glossy, smooth



281140H

weiß | blanc | white
seidenmatt, eben | satiné, lisse | silky-mat, smooth

30 x 90 cm

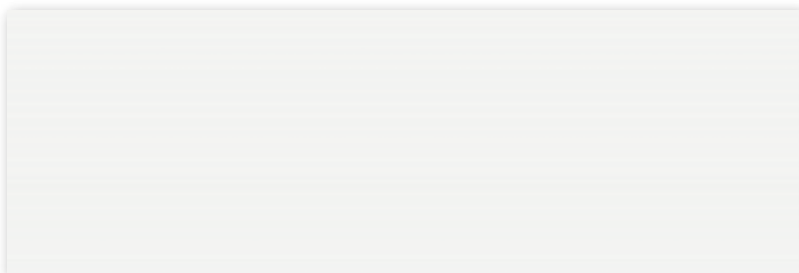

392735H

weiß | blanc | white
glänzend, eben | brillant, lisse | glossy, smooth

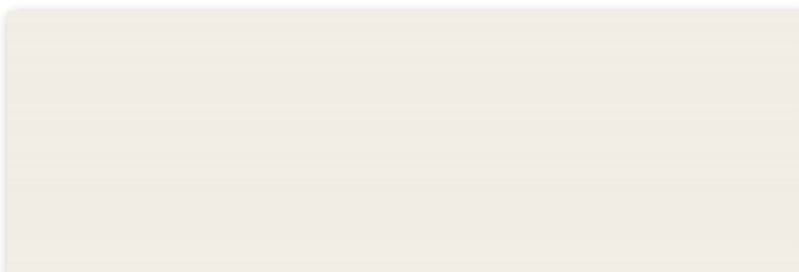

392736H

champagner | champagne | champagne
glänzend, eben | brillant, lisse | glossy, smooth

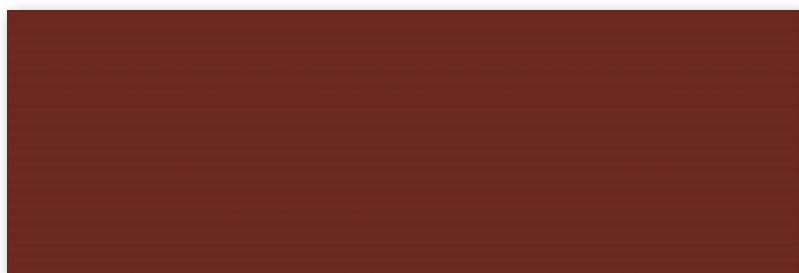

392738H

dunkelrot, | rouge foncé | dark-red
glänzend, eben | brillant, lisse | glossy, smooth

Art.	Nennmaß cote nominale nominal size cm	Herstellmaß cote de fabrication production size mm	m	Paket carton box	Palette palette pallet	Beanspr.-Gruppe groupe d'emploi wear resist. group	Norm Norme Standard	Trittsicherheit antidérapance non-slip	Preisgruppe groupe de prix price category
282731							Bla UGL		W493 (St pc)
282733	30 x 30	297 x 297 x 10,5	3,333 St pc	3 St pc			Bla UGL		W493 (St pc)
282734			6,666 kg	0,900 m	6,000 kg		Bla UGL		W493 (St pc)

Dekorationselemente | éléments décoratifs | decoration elements

Mosaikmatte Step | mosaïque Step | mosaic sheet Step

Feinsteinzeugfliesen unglasiert | grès fin non-émaillés | porcelain stoneware tiles unglazed

30 x 30 cm

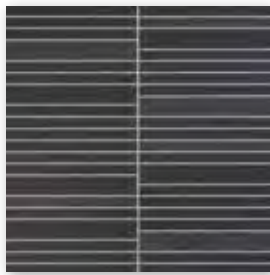

282731
anthrazit-schwarz
anthracite noir
anthracite-black
eben, teilpoliert
lisse, semi-polie
smooth, semi-polished

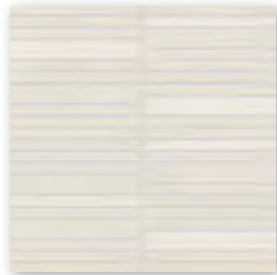

282733
hellbeige
beige clair
light-beige
eben, teilpoliert
lisse, semi-polie
smooth, semi-polished

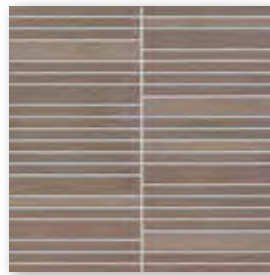

282734
mittelbraun
brun moyen
mid-brown
eben, teilpoliert
lisse, semi-polie
smooth, semi-polished



Mosaik, Verklebung rückseitig auf Glasfasernetz, Bogen: 297 x 297 mm. Nur für die Verlegung an der Wand geeignet.

Mosaïque, collée sur trame en fibre de verre à l'envers, Feuille: 297 x 297 mm. Convient uniquement pour une pose murale.

Mosaic, glass fibre net on reverse side, Sheet: 297 x 297 mm. Only suitable for laying on the wall.

Abgabe der Dekorationselemente ausschließlich in vollen Kartons.
Éléments décoratifs uniquement livrables en cartons entiers.
Decoration elements only available in full boxes.

Art.	Nennmaß cote nominale nominal size cm	Herstellmaß cote de fabrication production size mm	m ²	Paket carton box	Palette palette pallet	Beanspr.-Gruppe groupe d'emploi wear resist. group	Norm Norme Standard	Trittsicherheit antidérapance non-slip	Preisgruppe groupe de prix price category
392739H							BIII GL		W151 (m²)
392740H	30 x 90	297 x 897 x 10,5	3,704 St pc	5 St pc			BIII GL		W151 (m²)
392742H			17,976 kg	1,350 m ² 22,450 kg			BIII GL		W161 (m²)

Dekorationselemente | éléments décoratifs | decoration elements

Dekorfliese Step | carreau décoratif Step | decorative element Step

Steingut glasiert | faïence émaillée | earthenware glazed

30 x 90 cm

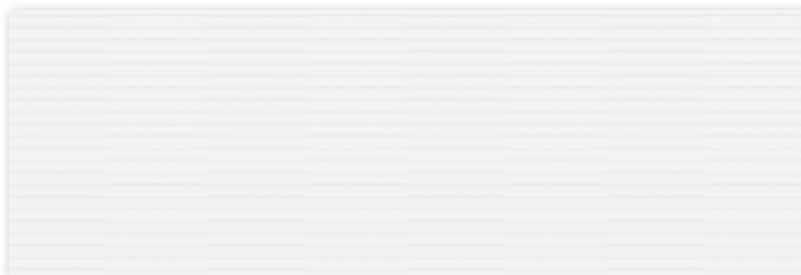

392739H

weiß | blanc | white
glänzend, eben | brillant, lisse | glossy, smooth

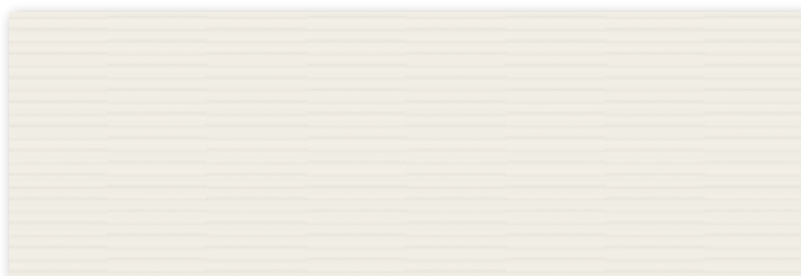

392740H

champagner | champagne | champagne
glänzend, eben | brillant, lisse | glossy, smooth



392742H

dunkelrot, | rouge foncé | dark-red
glänzend, eben | brillant, lisse | glossy, smooth

Abgabe der Dekorationselemente ausschließlich in vollen Kartons.
Éléments décoratifs uniquement livrables en cartons entiers.
Decoration elements only available in full boxes.







Abstrakte Schönheit genießen

Die Kollektion Jasba-CLARA interpretiert klassische ornamentale und geometrische Fliesenmuster modern und romantisch. Vintage-Fans lieben diese Fliesen. Auch, weil sie in ihren fünf zarten Ton-in-Ton Farben und mit ihren zwei Formaten ein sanftes und unverwechselbares Raumdesign schaffen. Klassische Musterungen in Reliefoptik treffen auf sanfte Cremefarben in Rosa und Blau, Grau und Grün. Wohlige Landhausatmosphäre liegt in der Luft. Und die schönsten Seiten des Vintage-Trends. Jasba-CLARA ist ein Hingucker in privaten Küchen, besonders kombiniert mit puristischen Wohnelementen. Im Essbereich entsteht sofort ein heimeliges Gefühl. In Bädern oder im Wellnessbereich ein Kokon der individuellen Geborgenheit. Speziell im Nassbereich, aber auch in Küchen spielt die Serie ihre Hytect Eigenschaften voll aus. Denn ihre Oberfläche wirkt antibakteriell, sie verhindert Schimmelbildung und sie ist besonders pflegeleicht.

Apprécier la beauté abstraite

La collection Jasba-CLARA interprète des motifs ornementaux et géométriques classiques des carreaux d'une manière moderne et romantique. Les amateurs de vintage adorent ces carreaux, aussi parce qu'avec leurs cinq couleurs délicates ton sur ton et leurs deux formats, ils créent une douce ambiance unique en son genre. Des motifs classiques en relief rencontrent des couleurs crème douces en rose et bleu, gris et vert. Il y règne une ambiance de maison de campagne chaleureuse, arrondie par les plus beaux éléments de la tendance vintage. Jasba-CLARA attire l'attention dans les cuisines privées, surtout lorsque la série est associée à des éléments d'habitation puristes. Un sentiment d'intimité est immédiatement créé dans le coin repas. Dans les salles de bains ou dans l'espace bien-être, on se sent dans un cocon de sécurité individuel. En particulier dans les zones mouillées, mais aussi dans les cuisines, la série met pleinement en valeur ses propriétés Hytect. Étant donné que sa surface a un effet antibactérien, elle empêche la formation de moisissures et est particulièrement facile à nettoyer.

Enjoying abstract beauty

The Jasba-CLARA collection interprets classic ornamental and geometric tile patterns in a modern and romantic way. Vintage fans love these tiles. Also because they create a soft and distinctive room design in their five delicate tone-in-tone colors and with their two formats. Classic patterns in relief look meet soft cream colors in pink and blue, grey and green. A cosy country house atmosphere is in the air. And the most beautiful sides of the vintage trend. Jasba-CLARA is an eye-catcher in private kitchens, especially when combined with puristic furniture. In the dining area, it immediately creates a homey feeling. In bathrooms or wellness areas, a cocoon of individual security. Especially in wet areas, but also in kitchens, the Hytect properties of the series come in useful. Its surface has an antibacterial effect, prevents the formation of mould and is particularly easy to clean.

Art.	Nennmaß cote nominale nominal size cm	Herstellmaß cote de fabrication production size mm	m ²	Paket carton box	Palette palette pallet	Beanspr.-Gruppe groupe d'emploi wear resist. group	Norm Norme Standard	Trittsicherheit antidérapance non-slip	Preisgruppe groupe de prix price category
432135H							Bla GL		W114 (m ²)
432136H	10 x 10	97 x 97 x 6,5	11,000 St pc	11 St pc	64,000 m ²		Bla GL		W114 (m ²)
432137H			13,101 kg	1,000 m ² 13,101 kg	838,464 kg		Bla GL		W114 (m ²)
432138H							Bla GL		W114 (m ²)
432139H							Bla GL		W114 (m ²)



country green



vintage rose



paris grey



iceland white

Mosaik | mosaïque | mosaic

Feinsteinzeugfliesen glasiert | grès cérame fin vitrifié émaillés | porcelain stoneware tiles glazed

10 x 10 cm



Mosaik, rückseitig thermoplastisch verklebt
Bogen: 297 x 297 mm
Mosaïque, collage thermoplastique sur l'envers
Feuille: 297 x 297 mm
Mosaic, glued thermo-plastically on back
Sheet: 297 x 297 mm

432135H    

nordic blue,
glänzend, strukturiert
brillant, structuré
glossy, structured

432136H
country green,
glänzend, strukturiert
brillant, structuré
glossy, structured

432137H
vintage rose,
glänzend, strukturiert
brillant, structuré
glossy, structured

432138H
paris grey,
glänzend, strukturiert
brillant, structuré
glossy, structured

432139H
iceland white,
glänzend, strukturiert
brillant, structuré
glossy, structured

Die Artikel Jasba-CLARA bestehen jeweils aus unterschiedlichen Motiven. Die Anordnung und Konfektionierung erfolgt zufällig und willkürlich.

Les articles Jasba-CLARA arborent des motifs différents. Ces motifs sont agencés et confectionnés de manière aléatoire et fortuite.

The articles Jasba-CLARA each depict different motifs. Arrangement and packing are random and arbitrary.

Art.	Nennmaß cote nominale nominal size cm	Herstellmaß cote de fabrication production size mm	m ²	Paket carton box	Palette palette pallet	Beanspr.-Gruppe groupe d'emploi wear resist. group	Norm Norme Standard	Trittsicherheit antidérapance non-slip	Preisgruppe groupe de prix price category
432140H							Bla GL	W114 (m ²)	
432141H	15 x 15	147 x 147 x 6,5	44,444 St pc / m	44 St pc	79,201 m ²		Bla GL	W114 (m ²)	
432142H			13,955 kg	0,990 m ²	13,816 kg	1105,280 kg	Bla GL	W114 (m ²)	
432143H							Bla GL	W114 (m ²)	
432144H							Bla GL	W114 (m ²)	



country green



vintage rose



paris grey



iceland white

Wandfliese | Carreau de mur | Wall tile

Feinsteinzeugfliesen glasiert | grès cérame fin vitrifié émaillés | porcelain stoneware tiles glazed

15 x 15 cm

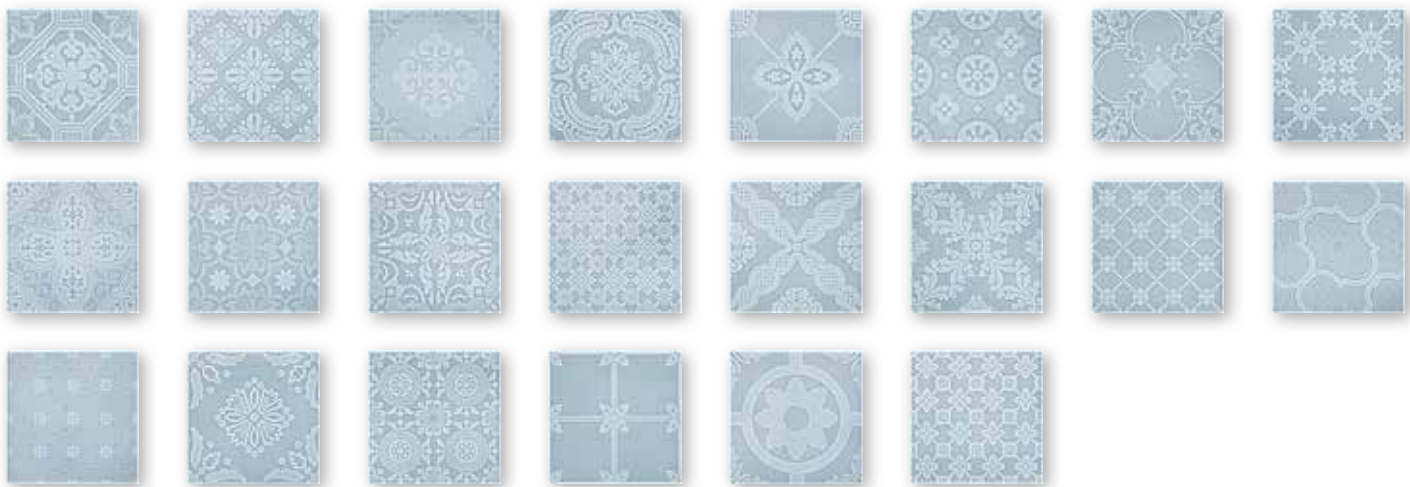

432140H

nordic blue,
glänzend, strukturiert
brillant, structuré
glossy, structured

432141H

country green,
glänzend, strukturiert
brillant, structuré
glossy, structured

432143H

paris grey,
glänzend, strukturiert
brillant, structuré
glossy, structured

432142H

vintage rose,
glänzend, strukturiert
brillant, structuré
glossy, structured

432144H

iceland white,
glänzend, strukturiert
brillant, structuré
glossy, structured

Die Artikel Jasba-CLARA bestehen jeweils aus unterschiedlichen Motiven. Die Anordnung und Konfektionierung erfolgt zufällig und willkürlich.

Les articles Jasba-CLARA arborent des motifs différents. Ces motifs sont agencés et confectionnés de manière aléatoire et fortuite.

Bodenempfehlung Serie Walden (Seite 226), Serie Stories (Seite 202), Serie Like (Seite 122).
Recommandation relative au sol, série Walden (page 226), série Stories (page 202), série Like (page 122).
Recommended floor tiles: series Walden (page 226), series Stories (page 202), series Like (page 122).

The articles Jasba-CLARA each depict different motifs. Arrangement and packing are random and arbitrary.



3D-Rendering / Architekt · architecte · architect: STELLWERK architekten, Dresden, Deutschland · Allemagne · Germany /
Serie · série · series: Jasba-PATTERN



Mit einem Hauch von Nostalgie

Ursprüngliches neu erleben. Motive spielerisch kombinieren, im Innen- wie im Außenbereich: Mit zusätzlichen Mustern und Einzeldekoren ist der „Vintage-Baukasten“ der erfolgreichen Serie Jasba-PATTERN umfangreich bestückt und fügt sich perfekt in jeden Wohnstil ein. Das Dekor Vanda bietet einen Mix aus 12 verschiedenen floralen und geometrischen Motiven. Als Einzelmotive bieten sich das florale Dekor Isola und das geometrische Dekor Baleno an. Alle drei Dekorvarianten harmonisieren durch ihre zarte Farbkombi mit der neuen Basisfliese in Zementgrau. Sie lassen sich aber auch zu vergrößerten Motiven aneinanderlegen – bis hin zum keramischen „Teppich“.

Avec une touche de nostalgie

Redécouvrir l'authenticité. Combiner des motifs de manière ludique, à l'intérieur comme à l'extérieur : Avec des motifs supplémentaires et des décors individuels, le « kit de construction vintage » de la série à succès Jasba-PATTERN est bien équipé et s'intègre parfaitement dans tous les styles d'habitat. L'élément de décor Vanda propose une palette de 12 motifs floraux et géométriques différents. Comme motifs individuels, le décor floral Isola et le décor géométrique que propose Baleno. Les trois variantes de décor s'harmonisent avec la nouvelle dalle de base en gris ciment grâce à leur composition chromatique délicate. Mais ils peuvent également être combinés pour créer des motifs agrandis, jusqu'au « tapis » en céramique.

With a breath of nostalgia

Experiencing original ideas anew, playfully combining motifs indoors and outdoors: with additional patterns and individual decorative elements, the “vintage modular system” of the successful series Jasba-PATTERN provides an extensive range of products and perfectly fits into any living style. The Vanda decorative element offers a mix of 12 different floral and geometric motifs. The floral Isola decorative element and the geometric Baleno decorative element are ideal as individual motifs. Thanks to their delicate color compositions, each of the three decorative variants harmonizes with the new basic tile in cement-grey. However, they can also be arranged to form larger motifs – or even a ceramic “carpet”.



Art.	Nennmaß cote nominale nominal size cm	Herstellmaß cote de fabrication production size mm	m ²	Paket carton box	Palette palette pallet	Beanspr.-Gruppe groupe d'emploi wear resist. group	Norm Norme Standard	Trittsicherheit antidérapance non-slip	Preisgruppe groupe de prix price category
42400H						3	Bib GL		W453 (St pc)
42401H	2,5 x 2,5	23 x 23 x 6,5	11 Bögen plaques sheets 12,100 kg	11 Bögen plaques sheets 1,000 m ² 12,160 kg	48,000 m ² 580,800 kg	3	Bib GL		W453 (St pc)
42402H						3	Bib GL		W453 (St pc)
42500H	5 x 5	47 x 47 x 6,5	11 Bögen plaques sheets 12,331 kg	11 Bögen plaques sheets 1,000 m ² 12,331 kg	64,000 m ² 789,184 kg	4	Bib GL	R10/B	W214 (m ²)
42501H						4	Bib GL	R10/B	W214 (m ²)

Mosaik | mosaïque | mosaic

Steinzeug glasiert | grès émaillé | stoneware glazed

2,5 x 2,5 cm



42400H    

Vola

mehrfarbig, seidenmatt, eben
multicolore, satinée, lisse
multicolored, silky-matt, smooth



42401H    

Vola

beige-braun, seidenmatt, eben
beige marron, satinée, lisse
beige-brown, silky-matt, smooth

Die Artikel Vola, Mesh, Salina und Vanda bestehen jeweils aus unterschiedlichen Motiven. Die Anordnung und Konfektionierung erfolgt zufällig und willkürlich.

Les articles Vola, Mesh, Salina et Vanda arborent des motifs différents. Ces motifs sont agencés et confectionnés de manière aléatoire et fortuite.

The articles Vola, Mesh, Salina and Vanda each depict different motifs. Arrangement and packing are random and arbitrary.

Mosaik, rückseitig thermoplastisch verklebt
Bogen: 297 x 297mm, ohne Außenfuge

Mosaïque, collage thermoplastique sur l'envers
Feuille: 297 x 297mm, sans joint extérieur

Mosaic, glued thermo-plastically on back
Sheet: 297 x 297mm, without external joint



42402H    

42500H    

Vola

grau, seidenmatt, eben
gris, satinée, lisse
grey, silky-matt, smooth



42501H    

Vola

grau, seidenmatt, eben
gris, satinée, lisse
grey, silky-matt, smooth

5 x 5 cm Secura



42500H    

Vola

mehrfarbig, seidenmatt, eben
multicolore, satinée, lisse
multicolored, silky-matt, smooth



42501H    

Vola

grau, seidenmatt, eben
gris, satinée, lisse
grey, silky-matt, smooth



Abgabe Mosaik 2,5 x 2,5 cm in vollen Kartons.
Mosaïques 2,5 x 2,5 cm uniquement livrables en cartons entiers.
Mosaics 2.5 x 2.5 cm only available in full boxes.

Art.	Nennmaß cote nominale nominal size cm	Herstellmaß cote de fabrication production size mm	m ²	Paket carton box	Palette palette pallet	Beanspr.-Gruppe groupe d'emploi wear resist. group	Norm Norme Standard	Trittsicherheit antidérapance non-slip	Preisgruppe groupe de prix price category
42010H						4	Bib GL		W114 (m ²)
42020H						4	Bib GL		W114 (m ²)
42000H	10 x 10	97 x 97 x 6,5	11 Bögen plaques sheets	11 Bögen plaques sheets	64,000 m ²	4	Bib GL		W84 (m ²)
42001H			13,101 kg	1,000 m ² 13,101 kg	838,464 kg	4	Bib GL		W84 (m ²)
42002H						4	Bib GL		W84 (m ²)

Mosaik | mosaïque | mosaic

Steinzeug glasiert | grès émaillé | stoneware glazed

10 x 10 cm



42010H

Mesh

Natur-mix, seidenmatt, eben
mélange nature, satinée, lisse
natural-mix, silky-matt, smooth



42020H

Vola

mehrfarbig, seidenmatt, eben
multicolore, satinée, lisse
multicolored, silky-matt, smooth



42000H

weiß, seidenmatt, eben
white, satinée, lisse
white, silky-matt, smooth



42001H

beige, seidenmatt, eben
beige, satinée, lisse
beige, silky-matt, smooth



42002H

grau, seidenmatt, eben
gris, satinée, lisse
grey, silky-matt, smooth

Mosaik, rückseitig thermoplastisch verklebt
Bogen: 297 x 297 mm

Mosaïque, collage thermoplastique sur l'envers
Feuille: 297 x 297 mm

Mosaic, glued thermo-plastically on back
Sheet: 297 x 297 mm

Die Artikel Vola, Mesh, Salina und Vanda bestehen jeweils aus unterschiedlichen Motiven. Die Anordnung und Konfektionierung erfolgt zufällig und willkürlich.

Les articles Vola, Mesh, Salina et Vanda arborent des motifs différents. Ces motifs sont agencés et confectonnés de manière aléatoire et fortuite.

The articles Vola, Mesh, Salina and Vanda each depict different motifs. Arrangement and packing are random and arbitrary.

Art.	Nennmaß cote nominale nominal size cm	Herstellmaß cote de fabrication production size mm	m ²	Paket carton box	Palette palette pallet	Beanspr.-Gruppe groupe d'emploi wear resist. group	Norm Norme Standard	Trittsicherheit antidérapance non-slip	Preisgruppe groupe de prix price category
42120H	20 x 20	197 x 197 x 6,5	25 St pc	25 St pc	72,000 m ²	4	Bib GL		W114 (m ²)
42121H			13,875 kg	1,000 m ² 13,875 kg	999,000 kg	4	Bib GL		W114 (m ²)

Wand- und Bodenfliese | Carreau de mur et de sol | Wall and floor tile

Steinzeug glasiert | grès émaillé | stoneware glazed

20 x 20 cm



42120H

Vola
mehrfarbig, seidenmatt, eben
multicolore, satinée, lisse
multicolored, silky-matt, smooth



42121H

Vola
grau, seidenmatt, eben
gris, satinée, lisse
grey, silky-matt, smooth

Die Artikel Vola, Mesh, Salina und Vanda bestehen jeweils aus unterschiedlichen Motiven. Die Anordnung und Konfektionierung erfolgt zufällig und willkürlich.

Les articles Vola, Mesh, Salina et Vanda arborent des motifs différents. Ces motifs sont agencés et confectionnés de manière aléatoire et fortuite.

The articles Vola, Mesh, Salina and Vanda each depict different motifs. Arrangement and packing are random and arbitrary.

Art.	Nennmaß cote nominale nominal size cm	Herstellmaß cote de fabrication production size mm	m ²	Paket carton box	Palette palette pallet	Beanspr.-Gruppe groupe d'emploi wear resist. group	Norm Norme Standard	Trittsicherheit antidérapance non-slip	Preisgruppe groupe de prix price category
42130H						4	Bib GL		W114 (m ²)
44400H	20 x 20	197 x 197 x 6,5	25 St pc	25 St pc	72,000 m ²	4	Bib GL		W114 (m ²)
44401H			13,875 kg	1,000 m ² 13,875 kg	999,000 kg	4	Bib GL		W114 (m ²)

Wand- und Bodenfliese | Carreau de mur et de sol | Wall and floor tile
Steinzeug glasiert | grès émaillé | stoneware glazed

20 x 20 cm



42130H
Salina
mehrfarbig, seidenmatt, eben
multicolore, satinée, lisse
multicolored, silky-matt, smooth

Einzelmotive | Motifs individuels | Individual motifs



44400H
Nelas
schwarz-weiß, seidenmatt, eben
noir-blanc, satinée, lisse
black-white, silky-matt, smooth



44401H
Mellby
grau, seidenmatt, eben
gris, satinée, lisse
grey, silky-matt, smooth

Die Artikel Vola, Mesh, Salina und Vanda bestehen jeweils aus unterschiedlichen Motiven. Die Anordnung und Konfektionierung erfolgt zufällig und willkürlich.

Les articles Vola, Mesh, Salina et Vanda arborent des motifs différents. Ces motifs sont agencés et confectionnés de manière aléatoire et fortuite.

The articles Vola, Mesh, Salina and Vanda each depict different motifs. Arrangement and packing are random and arbitrary.

Art.	Nennmaß cote nominale nominal size cm	Herstellmaß cote de fabrication production size mm	m ²	Paket carton box	Palette palette pallet	Beanspr.-Gruppe groupe d'emploi wear resist. group	Norm Norme Standard	Trittsicherheit antidérapance non-slip	Preisgruppe groupe de prix price category
42100H						4	Bib GL		W84 (m ²)
42101H	20 x 20	197 x 197 x 6,5	25 St pc	25 St pc	72,000 m ²	4	Bib GL		W84 (m ²)
42102H			13,875 kg	1,000 m ² 13,875 kg	999,000 kg	4	Bib GL		W84 (m ²)
42103H						3	Bib GL		W84 (m ²)
44425H							Bla UGL	R10/B	W84 (m ²)

Wand- und Bodenfliese | Carreau de mur et de sol | Wall and floor tile

Steinzeug glasiert | grès émaillé | stoneware glazed

20 x 20 cm



42100H
weiß seidenmatt, eben
blanc mat satiné, lisse
white silky-matt, smooth



42101H
beige seidenmatt, eben
beige mat satiné, lisse
beige silky-matt, smooth



42102H
grau seidenmatt, eben
gris mat satiné, lisse
grey silky-matt, smooth



42103H
anthrazit seidenmatt, eben
anthracite mat satiné, lisse
anthracite silky-matt, smooth

Feinsteinzeug unglasiert | grès cérame fin non émaillé | porcelain stoneware unglazed

20 x 20 cm Secura



44425H
cementgrau seidenmatt, eben
cement gris mat satiné, lisse
cement grey silky-matt, smooth

Art.	Nennmaß cote nominale nominal size cm	Herstellmaß cote de fabrication production size mm	m ²	Paket carton box	Palette palette pallet	Beanspr.-Gruppe groupe d'emploi wear resist. group	Norm Norme Standard	Trittsicherheit antidérapance non-slip	Preisgruppe groupe de prix price category
44447H							Bla UGL	R10/B	W114 (m ²)
44448H	20 x 20	197 x 197 x 6,5	25 St pc	25 St pc	72,000 m ²		Bla UGL	R10/B	W114 (m ²)
44449H			13,875 kg	1,000 m ² 13,875 kg	999,000 kg		Bla UGL	R10/B	W114 (m ²)

Wand- und Bodenfliese | Carreau de mur et de sol | Wall and floor tile

Feinsteinzeug unglasiert | grès cérame fin non émaillé | porcelain stoneware unglazed

20 x 20 cm Secura



44449H

Vanda
mehrfarbig, seidenmatt, eben
multicolore, satinée, lisse
multicolored, silky-matt, smooth

Einzel motive | Motifs individuels | Individual motifs

20 x 20 cm Secura



44447H

Baleno
mehrfarbig, seidenmatt, eben
multicolore, satinée, lisse
multicolored, silky-matt, smooth

44448H

Isola
mehrfarbig, seidenmatt, eben
multicolore, satinée, lisse
multicolored, silky-matt, smooth

Die Artikel Vola, Mesh, Salina und Vanda bestehen jeweils aus unterschiedlichen Motiven.
Die Anordnung und Konfektionierung erfolgt zufällig und willkürlich.

Les articles Vola, Mesh, Salina et Vanda arborent des motifs différents.
Ces motifs sont agencés et confectionnés de manière aléatoire et fortuite.

The articles Vola, Mesh, Salina and Vanda each depict different motifs.
Arrangement and packing are random and arbitrary.



Studioaufnahme · photo prise en studio · studio photo / Architekt · architecte · architect: VSBL, Belgrad, Serbien · Belgrade, Serbie · Belgrade, Serbia /
Serie · série · series: Jasba-RONDA / Photo: Jochen Stüber



Mal luxuriös, mal lässig – immer besonders

Jasba-RONDA ist das Ergebnis einer raffinierten Kombination verschiedenster Design- und Stilmittel: Patina-Glasuren, gitterartige Einschlüsse, historische Muster und bewusste Auslassungen. Die zwei Farben Cement Mix und Rost Mix unterstützen den Effekt einer korrodierten, „gelebten“ Oberfläche. Als Formate stehen Mosaik mit 2,5 x 2,5 cm und 5 x 5 cm, sowie ein trittsicheres 5 x 5 cm-Mosaik (R10/B) zur Verfügung. Alle Fliesen von Jasba-RONDA haben eine reinigungsfreundliche Hytect-Oberfläche.

Tantôt luxueux, tantôt nonchalant – toujours exceptionnel

Jasba-RONDA est né d'une combinaison subtile entre différents éléments de design et de style : vernis patiné, inserts grillagés, motifs historiques et omissions volontaires. Les deux teintes mélange ciment et mélange rouille renforce l'impression d'une surface corrodée qui a « vécu ». Le format mosaïque de 2,5 x 2,5 cm et 5 x 5 cm, et une mosaïque antidérapante de 5 x 5 cm (R10/B) sont disponibles dans la gamme. Tous les carreaux de Jasba-RONDA ont une surface Hytect facile à nettoyer.

Sometimes luxurious, sometimes casual – always special

Jasba-RONDA is the result of a sophisticated combination of various design and stylistic devices: patina glazes, mesh-like inclusions, historic patterns and intentional omissions. The two colors cement-mix and rust-mix support the effect of a corroded, “lively” surface finish. Available as mosaics in 2.5 x 2.5 cm and 5 x 5 cm and non-slip 5 x 5 cm mosaic (R10/B). All Jasba-RONDA tiles have an easy-clean Hytect surface.



Art.	Nennmaß cote nominale nominal size cm	Herstellmaß cote de fabrication production size mm	m ²	Paket carton box	Palette palette pallet	Beanspr.-Gruppe groupe d'emploi wear resist. group	Norme Norme Standard	Trittsicherheit antidérapance non-slip	Preisgruppe groupe de prix price category
43100H	2,5 x 2,5	23 x 23 x 6,5	11 Bögen plaques sheets 12,100 kg	11 Bögen plaques sheets 1,000 m ² 12,100 kg	48,000 m ² 580,800 kg	3 4	Bib GL Bib GL		W448 (St pc) W448 (St pc)
43200H	5 x 5	47 x 47 x 6,5	11 Bögen plaques sheets 12,331 kg	11 Bögen plaques sheets 1,000 m ² 12,331 kg	64,000 m ² 789,184 kg	3 4	Bib GL Bib GL		W196 (m ²) W196 (m ²)

Mosaik | mosaïque | mosaic



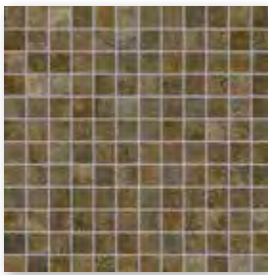

Steinzeug glasiert | grès émaillé | stoneware glazed

2,5 x 2,5 cm

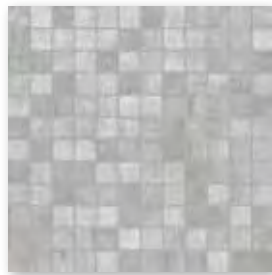





43100H    
rost-mix, eben, matt
mélange rouille, lisse, mat
rust-mix, smooth, matt



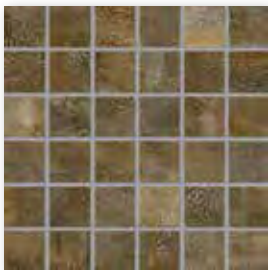



43101H    
zement-mix, eben, matt
mélange coement, lisse, mat
cement-mix, smooth, matt

5 x 5 cm



43200H    
rost-mix, eben, matt
mélange rouille, lisse, mat
rust-mix, smooth, matt



43201H    
zement-mix, eben, matt
mélange coement, lisse, mat
cement-mix, smooth, matt

Das von Ihnen gewählte Design variiert bewusst in der Farbigkeit. Dies gehört zur Charakteristik des Produktes.

Les variations de couleur du motif que vous avez sélectionné sont voulues. Ces variations font partie des caractéristiques.

The design you have chosen varies in color. This is inherent to the product.

Mosaik, rückseitig thermoplastisch verklebt
Bogen: 297 x 297 mm

Mosaïque, collage thermoplastique sur l'envers
Feuille: 297 x 297 mm

Mosaic, glued thermo-plastically on back
Sheet: 297 x 297 mm

Abgabe Mosaik 2,5 x 2,5 cm in vollen Kartons.
Mosaïques 2,5 x 2,5 cm uniquement livrables en cartons entiers.
Mosaics 2.5 x 2.5 cm only available in full boxes.

Art.	Nennmaß cote nominale nominal size cm	Herstellmaß cote de fabrication production size mm	m ²	Paket carton box	Palette palette pallet	Beanspr.-Gruppe groupe d'emploi wear resist. group	Norm Norme Standard	Trittsicherheit antidérapance non-slip	Preisgruppe groupe de prix price category
43225H	5 x 5	47 x 47 x 6,5	11 Bögen plaques sheets	11 Bögen plaques sheets	64,000 m ²	3	Bib GL	R10/B	W214 (m ²)
43226H			12,331 kg	1,000 m ² 12,331 kg	789,184 kg	4	Bib GL	R10/B	W214 (m ²)

Mosaik | mosaïque | mosaic





Steinzeug glasiert | grès émaillé | stoneware glazed

5 x 5 cm Secura



43225H    
 rost-mix, eben, matt
 mélange roulle, lisse, mat
 rust-mix, smooth, matt



43226H    
 zement-mix, eben, matt
 mélange coement, lisse, mat
 cement-mix, smooth, matt

Mosaik, rückseitig thermoplastisch verklebt
 Bogen: 297 x 297 mm

Mosaïque, collage thermoplastique sur l'envers
 Feuille: 297 x 297 mm

Mosaic, glued thermo-plastically on back
 Sheet: 297 x 297 mm

Das von Ihnen gewählte Design variiert bewusst in der Farbigkeit. Dies gehört zur Charakteristik des Produktes.

Les variations de couleur du motif que vous avez sélectionné sont voulues. Ces variations font partie des caractéristiques.

The design you have chosen varies in color. This is inherent to the product.

Zeitgeist meets zeitlos

Die Keramikfliesen-Serie Jasba-SENJA PURE gibt Bädern und privaten Wellnessbereichen einen wohnlichen Touch und eine warme, lebendige Anmutung. Ihre naturnahen Farbtöne und sanft strukturierten Oberflächen sind trendy und gleichzeitig zeitlos schön. Das Ergebnis: Harmonisch aufeinander abgestimmte Räume im klaren Vintage Style, im wohltuend zurückhaltenden Nordic Design oder im Shabby-Chic-Style. Die erfolgreiche Kollektion wurde jetzt um die kräftige Farbe Shabby-Chic-Brown und um großformatige naturweiße Wandfliesen erweitert – das bietet noch mehr Spielraum für Gestaltung. Bodenfliesen gibt es mit trittsicherer Oberfläche und die Jasba-SENJA PURE sind dank Hytect Oberfläche pflegeleicht und sie wirken hygienisch.

Le Zeitgeist rencontre l'intemporel

La série de carreaux céramiques Jasba-SENJA PURE confère aux salles de bains et aux espaces de bien-être privés une touche de confort et une atmosphère chaleureuse et vivante. Leurs coloris naturels et leurs surfaces doucement structurées sont à la fois tendance et d'une beauté intemporelle. Le résultat : des pièces harmonieusement coordonnées dans un style vintage clair, dans un design nordique apaisant et sobre ou dans un style shabby chic. La collection à succès a maintenant été étendue pour inclure la couleur audacieuse Shabby Chic Brown et des carreaux muraux blancs naturels de grand format – offrant encore plus de possibilités de conception. Les carreaux de sol sont disponibles avec une surface antidérapante et les Jasba-SENJA PURE sont faciles à nettoyer tout en ayant un effet hygiénique grâce à la surface Hytect.

Zeitgeist meets timeless

The Jasba-SENJA PURE ceramic tile series gives bathrooms and private wellness areas a cosy touch and a warm, lively impression. Its natural colors and finely structured surfaces are trendy and at the same time timelessly beautiful. The result: rooms harmoniously matched to one another in clear vintage style, in pleasantly restrained Nordic Design or in Shabby-Chic-Style. The successful collection has now been extended to include the strong color Shabby-Chic-Brown and large-size natural-white wall tiles – thus offering even more scope for design. Floor tiles are available with a slip-resistant surface, and Jasba-SENJA PURE is easy to clean thanks to its Hytect surface, which makes it hygienic.





Jasba-SENJA-PURE

Art.	Nennmaß cote nominale nominal size cm	Herstellmaß cote de fabrication production size mm	m ²	Paket carton box	Palette palette pallet	Beanspr.-Gruppe groupe d'emploi wear resist. group	Norm Norme Standard	Trittsicherheit antidérapance non-slip	Preisgruppe groupe de prix price category
3221H						4	B1b GL		W448 (St pc)
3222H						3	B1b GL		W448 (St pc)
3227	2,5 x 2,5	23 x 23 x 6,5	11 Bögen plaques sheets	11 Bögen plaques sheets	48,000 m ²	2	B1b GL		W462 (St pc)
3228H			12,100 kg	1,000 m ² 12,100 kg	580,800 kg	2	B1b GL		W448 (St pc)
3303H						4	B1b GL		W448 (St pc)
3304H						4	B1b GL		W448 (St pc)
3305H						4	B1b GL		W453 (St pc)
3306						1	B1b GL		W462 (St pc)

Mosaik | mosaïque | mosaic

Steinzeug glasiert | grès émaillé | stoneware glazed

2,5 x 2,5 cm

neu · nouveau · new



3221H

ahorn | érable | maple
strukturiert, matt | structuré,
mat | structured, matt

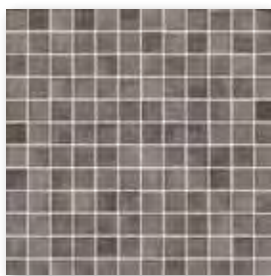

3222H

shabby chic brown
strukturiert, matt | structuré, mat |
structured, matt



3227

wenge-metallic | wengé-métallique
strukturiert, matt | structuré, mat |
structured, matt

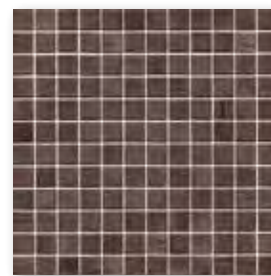

3228H

wenge | wengé
strukturiert, matt | structuré,
mat | structured, matt



3303H

eiche | chêne | oak
strukturiert, matt | structuré,
mat | structured, matt



3304H

shabby chic
strukturiert, matt | structuré, mat |
structured, matt



3305H

wood-mix | mélange bois
strukturiert, matt | structuré, mat |
structured, matt



3306

wood-mix metallic | mélange bois métallisé
strukturiert, matt | structuré, mat |
structured, matt

Mosaik, rückseitig thermoplastisch verklebt
Bogen: 297 x 297 mm.

Mosaïque, collage thermoplastique
sur l'envers Feuille: 297 x 297 mm.

Mosaic, glued thermo-plastically on back
Sheet: 297 x 297 mm.

Abgabe Mosaik
2,5 x 2,5 cm in vollen Kartons.

Mosaïques 2,5 x 2,5 cm
uniquement livrables en cartons entiers.

Mosaics 2.5 x 2.5 cm
only available in full boxes.

Art.	Nennmaß cote nominale nominal size cm	Herstellmaß cote de fabrication production size mm	m ²	Paket carton box	Palette palette pallet	Beanspr.-Gruppe groupe d'emploi wear resist. group	Norm Norme Standard	Trittsicherheit antidérapance non-slip	Preisgruppe groupe de prix price category
3201H						4	Bib GL	R10/B	W453 (St pc)
3202H						2	Bib GL	R10/B	W453 (St pc)
3203H	2,5 x 2,5	23 x 23 x 6,5	11 Bögen plaques sheets	11 Bögen plaques sheets	48,000 m ²	4	Bib GL	R10/B	W453 (St pc)
3206H			12,100 kg	1,000 m ² 12,100 kg	580,800 kg	3	Bib GL	R10/B	W453 (St pc)
3314H						4	Bib GL	R10/B	W453 (St pc)

Mosaik | mosaïque | mosaic

Steinzeug glasiert | grès émaillé | stoneware glazed

2,5 x 2,5 cm Secura





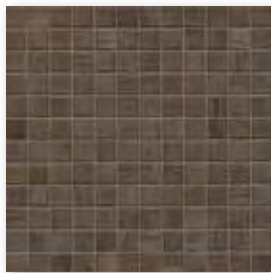

3201H    
 ahorn | érable | maple
 strukturiert, matt | structuré, mat |
 structured, matt



3202H    
 wenge | wengé
 strukturiert, matt | structuré, mat |
 structured, matt



3203H    
 eiche | chêne | oak
 strukturiert, matt | structuré, mat |
 structured, matt

neu · nouveau · new

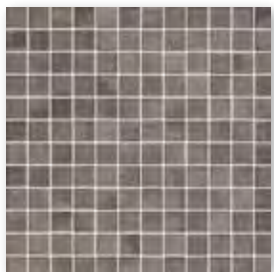

3206H    
 shabby chic brown
 strukturiert, matt | structuré, mat |
 structured, matt



3314H    
 shabby chic
 strukturiert, matt | structuré, mat |
 structured, matt

Mosaik, rückseitig thermoplastisch verklebt
 Bogen: 297 x 297 mm.

Mosaïque, collage thermoplastique
 sur l'envers Feuille: 297 x 297 mm.

Mosaic, glued thermo-plastically on back
 Sheet: 297 x 297 mm.

Abgabe Mosaik
 2,5 x 2,5 cm in vollen Kartons.

Mosaïques 2,5 x 2,5 cm
 uniquement livrables en cartons entiers.

Mosaics 2.5 x 2.5 cm
 only available in full boxes.

Jasba-SENJA-PURE

Art.	Nennmaß cote nominale nominal size cm	Herstellmaß cote de fabrication production size mm	m ²	Paket carton box	Palette palette pallet	Beanspr.-Gruppe groupe d'emploi wear resist. group	Norm Norme Standard	Trittsicherheit antidérapance non-slip	Preisgruppe groupe de prix price category
3251H						4	Bib GL	R10/B	W214 (m ²)
3252H	5 x 5	47 x 47 x 6,5	11 Bögen plaques sheets	11 Bögen plaques sheets	64,000 m ²	3	Bib GL	R10/B	W214 (m ²)
3258H			12,331 kg	1,000 m ² 12,331 kg	789,184 kg	2	Bib GL	R10/B	W214 (m ²)
3353H						4	Bib GL	R10/B	W214 (m ²)
3354H						4	Bib GL	R10/B	W214 (m ²)

Mosaik | mosaïque | mosaic

Steinzeug glasiert | grès émaillé | stoneware glazed

5 x 5 cm Secura

neu · nouveau · new

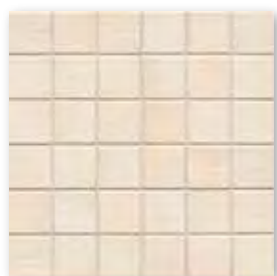

3251H

ahorn | érable | maple
strukturiert, matt | structuré, mat |
structured, matt



3252H

shabby chic brown
strukturiert, matt | structuré, mat |
structured, matt



3258H

wenge | wengé
strukturiert, matt | structuré, mat |
structured, matt



3353H

eiche | chêne | oak
strukturiert, matt | structuré, mat |
structured, matt



3354H

shabby chic
strukturiert, matt | structuré, mat |
structured, matt

Mosaik, rückseitig thermoplastisch verklebt

Bogen: 297 x 297 mm, ohne Außenfuge

Mosaïque, collage thermoplastique

sur l'envers Feuille: 297 x 297 mm, sans joint extérieur

Mosaic, glued thermo-plastically on back

Sheet: 297 x 297 mm, without external joint

Art.	Nennmaß cote nominale nominal size cm	Herstellmaß cote de fabrication production size mm	m ²	Paket carton box	Palette palette pallet	Beanspr.-Gruppe groupe d'emploi wear resist. group	Norm Norme Standard	Trittsicherheit antidérapance non-slip	Preisgruppe groupe de prix price category
23330H	20 x 60	197 x 597 x 9	8,333 St pc 15,516 kg	8 St pc 0,960 m ² 14,896 kg	61,442 m ² 953,344 kg		BIII GL	W91 (m ²)	
203331H	30 x 60	297 x 597 x 6	5,556 St pc 10,279 kg	13 St pc 2,340 m ² 24,050 kg	112,311m ² 1.154,400 kg		BIII GL	W63 (m ²)	
323332H	30 x 90	297 x 897 x 6	3,704 St pc 10,400 kg	8 St pc 2,160 m ² 22,464 kg	51,836 m ² 539,136 kg		BIII GL	W124 (m ²)	

Wandfliese | carreau de mur | wall tile
Steingut glasiert | faïence émaillée | earthenware glazed

20 x 60 cm



23330H

pergamentweiß | blanc parchemin | parchment white
seidenmatt, eben | satinée, lisse | silky-matt, smooth



Wandfliese | carreau de mur | wall tile
Steinzeug glasiert | grès émaillé | stoneware glazed

30 x 60 cm

neu · nouveau · new

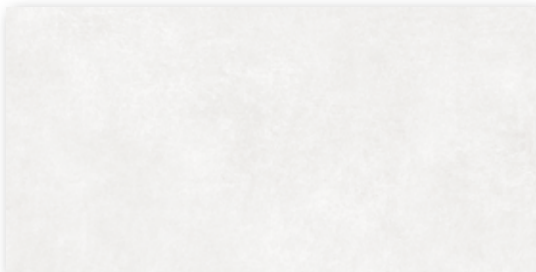

203331H *

naturweiß | blanc nature | natural-white
seidenmatt, eben | satinée, lisse | silky-matt, smooth



30 x 90 cm

neu · nouveau · new

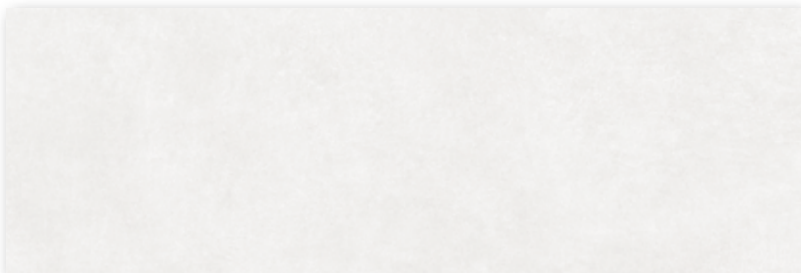

323332H *

naturweiß | blanc nature | natural-white
seidenmatt, eben | satinée, lisse | silky-matt, smooth



* Design & Farbe im Format 20 x 60 cm unterscheiden sich von den Formaten 30 x 60 cm und 30 x 90 cm.

* Le design et la couleur du format 20 x 60 cm diffèrent de ceux des formats 30 x 60 cm et 30 x 90 cm.

* The design and colour in the format of 20 x 60 cm differ from the formats of 30 x 60 cm and 30 x 90 cm.



Serie · série · series: Jasba-VILLAGE



Schiefer als Dekoelement?

Die Jasba-VILLAGE Kollektion mit ihrem reizvollen Schieferrelief macht dies möglich und spricht dabei nicht nur Auge sondern auch Tastsinn an. Ruhige Farben schaffen in Kombination mit der Schieferoptik eine warme, einladende Atmosphäre.

L'ardoise comme élément décoratif ?

La collection Jasba-VILLAGE le permet, avec son charmant relief en ardoise, qui non seulement tape à l'œil mais aussi réveille le sens du toucher. Les couleurs calmes associées à l'aspect ardoise créent une atmosphère chaleureuse et accueillante.

Slate as a decorative element?

The Jasba-VILLAGE collection with its charming slate relief makes this possible and appeals not only to the eye but also to the tactile sense. Calm colours combined with the slate look create a warm, inviting atmosphere.

Art.	Nennmaß cote nominale nominal size cm	Herstellmaß cote de fabrication production size mm	m ²	Paket carton box	Palette palette pallet	Beanspr.-Gruppe groupe d'emploi wear resist. group	Norm Norme Standard	Trittsicherheit antidérapance non-slip	Preisgruppe groupe de prix price category
3540H						4	Bib GL		W196 (m ²)
3541H						4	Bib GL		W196 (m ²)
3546H	5 x 5	47 x 47 x 6,5	11 Bögen plaques sheets	11 Bögen plaques sheets	64,000 m ²	3	Bib GL		W196 (m ²)
3547H			12,331 kg	1,000 m ² 12,331 kg	789,184 kg	4	Bib GL		W196 (m ²)
3548H						4	Bib GL		W196 (m ²)
3549H						3	Bib GL		W196 (m ²)

Mosaik | mosaïque | mosaic

Steinzeug glasiert | grès émaillé | stoneware glazed

5 x 5 cm



3540H*
 steinweiß, strukturiert, matt
 blanc pierre, structuré, mat
 stone white, structured, matt



3541H
 sandbeige, strukturiert, matt
 beige sable, structuré, mat
 sand beige, structured, matt

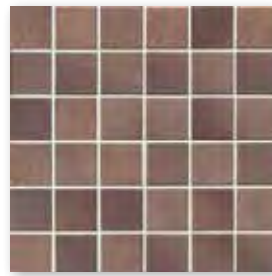

3546H*
 erdbraun, strukturiert, matt
 brun terre, structuré, mat
 earth brown, structured, matt



3547H
 felsgrau, strukturiert, matt
 gris roche, structuré, mat
 rock grey, structured, matt



3548H
 cotto, strukturiert, matt
 cotto, structuré, mat
 cotto, structured, matt



3549H
 schiefer, strukturiert, matt
 ardoise, structuré, mat
 slate-colored, structured, matt

Mosaik, rückseitig thermoplastisch verklebt
 Bogen: 297 x 297 mm.

Mosaïque, collage thermoplastique
 sur l'envers Feuille: 297 x 297 mm.

Mosaic, glued thermo-plastically on back
 Sheet: 297 x 297 mm.

*Mosaik, Verklebung rückseitig auf Glasfasernetz,
 Bogen: 297 x 297 mm, ohne Außenfuge

*Mosaïque, collée sur trame en fibre de verre à l'envers,
 Feuille: 297 x 297 mm, sans joint extérieur

*Mosaic, glass fibre net on reverse side,
 Sheet: 297 x 297 mm, without external joint

Art.	Nennmaß cote nominale nominal size cm	Herstellmaß cote de fabrication production size mm	m ²	Paket carton box	Palette palette pallet	Beanspr.-Gruppe groupe d'emploi wear resist. group	Norm Norme Standard	Trittsicherheit antidérapance non-slip	Preisgruppe groupe de prix price category
3500H						4	Bib GL	R10/B	W214 (m ²)
3501H						4	Bib GL	R10/B	W214 (m ²)
3503H	5 x 5	47 x 47 x 6,5	11 Bögen plaques sheets	11 Bögen plaques sheets	64,000 m ²	3	Bib GL	R10/B	W214 (m ²)
3506H			12,331 kg	1,000 m ² 12,331 kg	789,184 kg	3	Bib GL	R10/B	W214 (m ²)
3507H						4	Bib GL	R10/B	W214 (m ²)
3508H						4	Bib GL	R10/B	W214 (m ²)
3509H						3	Bib GL	R10/B	W214 (m ²)

Mosaik | mosaïque | mosaic

Steinzeug glasiert | grès émaillé | stoneware glazed

5 x 5 cm Secura



3500H steinweiß, strukturiert, matt
blanc pierre, structuré, mat
stone white, structured, matt



3501H sandbeige, strukturiert, matt
beige sable, structuré, mat
sand beige, structured, matt



3503H felsgrau-schiefer-mix,
strukturiert, matt
mélange gris roche-ardoise,
structuré, mat
rock grey-slate mix,
structured, matt



3506H erdbraun, strukturiert, matt
brun terre, structuré, mat
earth brown, structured, matt



3507H felsgrau, strukturiert, matt
gris roche, structuré, mat
rock grey, structured, matt



3508H cotto, strukturiert, matt
cotto, structuré, mat
cotto, structured, matt



3509H schiefer, strukturiert, matt
ardoise, structuré, mat
slate-colored, structured, matt

Mosaik, rückseitig thermoplastisch verklebt
Bogen: 297 x 297 mm.

Mosaïque, collage thermoplastique
sur l'envers Feuille: 297 x 297 mm.

Mosaic, glued thermo-plastically on back
Sheet: 297 x 297 mm.

Art.	Nennmaß cote nominale nominal size cm	Herstellmaß cote de fabrication production size mm	m ²	Paket carton box	Palette palette pallet	Beanspr.-Gruppe groupe d'emploi wear resist. group	Norm Norme Standard	Trittsicherheit antidérapance non-slip	Preisgruppe groupe de prix price category
0002	30 x 60	316 x 632 x 2,5	5 Bögen plaques sheets 0,380 kg	5 Bögen plaques sheets 1,000 m ² 0,380 kg	30,000 m ² 11,400 kg				W23 (m ²)

Höhenausgleichsmatte
natte de compensation de hauteur
levelling mat

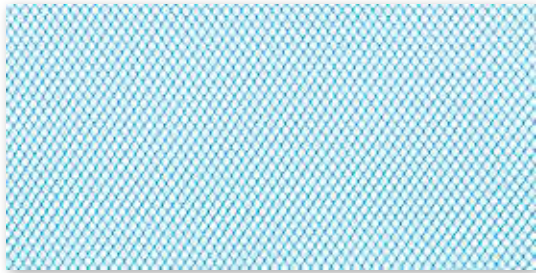

0002Nivella

Jasba-NIVELLA Höhengleichsmatte

Jasba-NIVELLA dient als Problemlöser für den Ausgleich des Höhenunterschieds zwischen dem Mosaik (6,5 mm) und den Wand- und Bodenfliesen (8 mm). Sie sorgt somit für eine durchgehend ebene Fläche und damit vollendete Raumwirkung. Jasba-NIVELLA ist ideal für die Arbeit mit kleinformatischen Belägen und geeignet für den Innen- und Außenbereich. Ein weiterer Vorteil ist von akustischer Natur: wirkungsvoll minimiert Jasba-NIVELLA eventuelle Hohlklang-Effekte. Auf das jeweilig benötigte Maß zugeschnitten, wird die Matte vollflächig in den Verlegemörtel gedrückt. Die bebilderte, ausführliche Verlegeanleitung finden Sie auf www.jasba.de.

Jasba-NIVELLA natte de compensation de hauteur

La natte Jasba-NIVELLA solutionne de manière optimale le problème de la différence de hauteur entre la mosaïque (6,5 mm) et les carreaux de mur et de sol (8 mm). Elle permet d'obtenir une surface plane et une uniformité parfaite. Jasba-NIVELLA est idéale pour la pose de revêtements de petit format pour l'intérieur et l'extérieur. L'autre avantage de Jasba-NIVELLA est d'ordre acoustique : elle évite la présence de cavités sonnantes creux. Découpée aux dimensions souhaitées, la natte est appliquée sur le support enduit de mortier de pose. Vous trouverez les instructions de pose détaillées et illustrées sur www.jasba.de.

Jasba-NIVELLA levelling mat

Jasba-NIVELLA mats solve the problem of levelling height differences between mosaics (6.5 mm) and wall and floor tiles (8 mm). They therefore ensure a consistently even surface conveying a perfect sensation of space. Jasba-NIVELLA is ideal for working with small-format tiles and suitable for use in both indoor and outdoor applications. Another advantage is of an acoustic nature: Jasba-NIVELLA effectively minimizes any hollow-sounding effects. Cut to the required size, the mat is pressed fully into the tile adhesive. Illustrated installation instructions are provided at www.jasba.de.

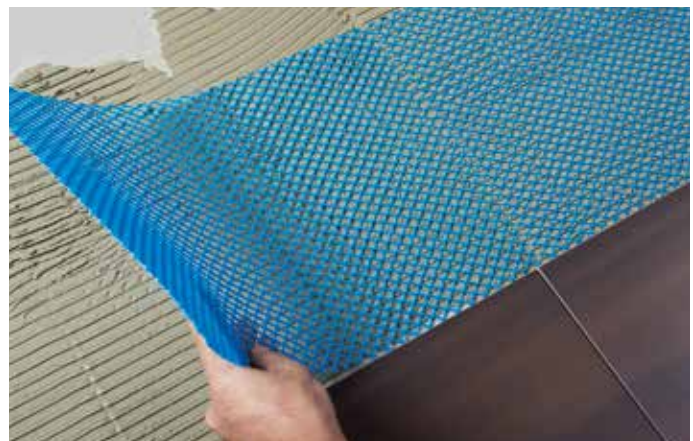

Gesonderte Konditionsregelung bei Zubehör · conditions spéciales pour les accessoires · special conditions for accessories



Höhenausgleichsmatte für den gewerblichen und privaten Einsatz im Innen- und Außenbereich (Wand & Boden)

Natte de compensation de hauteur à usage privé et professionnel pour intérieur et extérieur (mur et sol)

Levelling mat for commercial and private use in indoor and outdoor applications (walls / floors)

Eigenschaften:

- Höhenausgleichend
- Speziell unter kleinformatischen Belägen
- Kein Hohlklang
- Hohe Haftzugfestigkeit

Produktbeschreibung:

Jasba-NIVELLA ist eine spezielle Höhenausgleichsmatte zur idealen Kombination der Jasba Mosaik (6,5 mm) mit den angebotenen Wand- und Bodenfliesen (8 mm). Hohe Haftzugwerte sowie Biege-, Zug- und Druckfestigkeit sind prägnante Leistungsmerkmale dieser Höhenausgleichsmatte.

Untergründe:

Untergründe, auf denen Jasba-NIVELLA zum Einsatz kommen soll, müssen grundsätzlich auf Ebenheit, Tragfähigkeit und Oberflächenfestigkeit geprüft werden. Höhenversätze sind auszuschließen. Haftungsmindernde Schichten sind durch Schleifen zu entfernen. Grundierungen, abgestimmt auf Untergrund, Verlegemörtel bzw. Ausgleichsschichten sind gegebenenfalls vorzusehen. Ausgleichspachtelungen, Höhenausgleiche sind vor dem Verlegen

der Höhenausgleichsmatte auch für die angrenzenden Beläge herzustellen. Feuchtigkeitsempfindliche Untergründe sind durch entsprechende Abdichtungsmaßnahmen zu schützen.

- Zementäre Untergründe wie Estriche, Beton mind. 28 Tage alt, junge Estriche nach Begehbarkeit bis 7 Tage
- Calciumsulfatestriche mit Restfeuchten < 1%
- Gussasphaltestriche
- Magnesia/Steinholzestriche
- Heizestriche
- Trockenestriche
- Alte, feste keramische Beläge
- Alte Natursteinbeläge
- Gipskartonplatten
- Faserzementplatten
- Putze

Technische Daten

Breite: 316 mm · Länge: 632 mm
 Stärke: 2,5 mm · Farbe: Blau
 Brandklasse: B2
 Verkehrslast bis: 2 KN/m² (Kategorie A1-B1)
 Punktlast für Fliesen im Format 1 x 1 cm:
 Nicht größer als 0,25 KN/cm²
 (entspricht ca. 25 kg/cm²)

Propriétés

- Compensation de hauteur
- Destiné spécialement aux revêtements de petit format
- Absence de bruit creux
- Grande adhérence

Description du produit

mosaïque Jasba (6,5 mm) avec les carrelages de mur et de sol (8 mm) proposés. Cette natte de compensation de hauteur se caractérise par une excellente adhérence ainsi que par une résistance à la flexion, à l'arrachage et à la pression.

Supports

Les supports sur lesquels Jasba-NIVELLA est posé doivent être plans, porteurs et présenter une bonne résistance à l'effritement. Il faut absolument éviter les différences de hauteur. Les couches altérant l'adhérence sont à poncer et, il convient, le cas échéant, prévoir une mise à niveau y compris avec les surfaces avoisinantes. Les supports sensibles à l'humidité sont à étanchéifier avec des mesures appropriées.

- Supports en ciment tels que chape ou béton après au moins 28 jours, chape récente 7 jours après praticabilité
- Chapes de sulfate de calcium avec humidité relative < 1%
- Chapes d'asphalte coulé
- Chapes de magnésie/xytolite
- Chapes chauffantes
- Chapes sèches
- Anciens revêtements en céramique
- Anciens revêtements en pierre naturelle
- Panneaux de placoplâtre
- Panneaux fibrociment
- Crépis

Caractéristiques techniques

Largeur : 316 mm · Longueur : 632 mm
 Epaisseur : 2,5 mm · Couleur : bleu
 Cat. Incendie : B2
 Charge de roulement: 2 KN/m² maxi
 (catégorie A1-B1)
 Charge ponctuelle pour carrelage de format
 1 x 1 cm: inférieure à 0,25 KN/cm²
 (correspond à env. 25 kg/cm²)

Features:

- Levelling
- Especially under small-format coverings
- No hollow sound
- High tensile bond strength

Product description:

The Jasba-NIVELLA is a special levelling mat which is ideal for combining Jasba mosaics (6.5 mm) with the wall and floor tiles (8 mm) offered. High tensile bond strength as well as bending, tensile and compressive strength are the distinctive performance features of this levelling mat.

Surfaces:

The surfaces on which Jasba-NIVELLA is used must be examined for evenness, loadbearing capacity and surface strength. Differences in floor levels must be eliminated. Adhesion-inhibiting layers must be removed by grinding. Primers co-ordinated to the surface, grout and/or levelling layers must also be used. Compensation filling and levelling – including for the adjacent coverings – must be performed prior to fitting the levelling mat. Surfaces which are

sensitive to moisture must be protected by performing the appropriate sealing measures.

- Cement-based surfaces such as screed or concrete must be at least 28 days old; new screed up to 7 days after accessibility.
- Calcium sulphate screed with residual moisture < 1%
- Poured asphalt screed
- Magnesia/Stonewood screed
- Heated screed
- Dry screed
- Old, firm ceramic coverings
- Old natural stone coverings
- Plasterboard
- Fibre cement boards
- Plaster

Technical data

Width: 316 mm · Length: 632 mm
 Thickness: 2.5 mm · Color: blue
 Fire class: B2
 Load resistance: 2 KN/m² (category A1-B1)
 Spot load for tiles in 1 x 1 cm format:
 not greater than 0,25 KN/cm²
 (approx. 25 kg/cm²)

Lotrechte Nutzlasten für Decken nach DIN 1055-3 (Auszug)				
Kategorie	Nutzung	Beispiele	Flächenlast Q _k (kN/m ²)	Einzellast Q _k (kN)
A1	Spitzböden	Dachraum bis 1,8 m lichter Höhe	1,0	1,0
A2	Wohn- und Aufenthaltsräume	Räume mit ausreichender Querverteilung der Lasten wie Räume und Flure in Wohngebäuden, Hotelzimmern, sowie Bettenräume in Krankenhäusern	1,5	–
A3		wie A2, aber ohne ausreichende Querverteilung	2,0	1,0
B1	Büro, Arbeitsflächen	Flure in Bürogebäuden, Büroflächen, Arztpraxen, Stationsräume, Aufenthaltsräume einschl. der Flure, Kleinviehställe	2,0	2,0

Verarbeitung:

Auf den vorbereiteten Untergrund geeigneten Fliesenkleber nach DIN EN 12004 C2 und DIN EN 12002 S1 auftragen. Die Matten der Jasba-NIVELLA werden auf das erforderliche Maß zugeschnitten und vollflächig in den zuvor aufgetragenen Kleber eingebettet und dicht gestoßen. Der Fliesenkleber wird gleichmäßig in die Vertiefungen (Gitterstruktur) eingespachtelt. Die Gitterhohlräume müssen hierbei überall zu 100% gefüllt werden. Mit der entsprechenden Zahnleiste den Verlegemörtel aufkämmen und das Jasba Mosaik verlegen. Frühestens nach 24 Stunden werden die Flächen mit einem kunststoffvergüteten Fugenmörtel verfügt.

Achtung:

Die richtige und damit erfolgreiche Anwendung unserer Produkte unterliegt nicht unserer Kontrolle. Eine Gewährleistung kann deshalb nur für die Güte unserer Erzeugnisse im Rahmen unserer Verkaufs- und Lieferbedingungen (einzu sehen unter www.jasba.de/impressum.html), nicht aber für die erfolgreiche Verarbeitung übernommen werden. Veränderungen, die einen technischen Fortschritt bedeuten, behalten wir uns vor.

Charges utiles d'aplomb pour planchers selon DIN 1055-3 (extrait)				
Catégorie	Usage	Exemples	Charge en surface Q _k (kN/m ²)	Charge unique Q _k (kN)
A1	Combles	Grenier jusqu'à 1,8 m de hauteur de passage	1,0	1,0
A2	Pièces d'habitation et salles de séjour	Pièces avec une distribution latérale suffisante des charges comme espaces et couloirs dans les logements, les chambres d'hôtel ainsi que les chambres dans les hôpitaux	1,5	–
A3		comme A2 mais sans distribution latérale suffisante	2,0	1,0
B1	Espaces de bureaux et de travail	Couloirs dans bâtiments de bureaux, espaces bureaux, cabinets médicaux, salles d'attente, salles de séjour y compris couloirs, étables pour bétail de petite taille	2,0	2,0

Application :

Enduire le support préparé avec un mortier colle adapté selon DIN EN 12004 C2 et DIN EN 12002 S1. Les nattes Jasba-NIVELLA sont découpées à la dimension requise et collées sur toute la surface en ayant pris soin d'avoir rempli les cavités à 100%. Appliquer le mortier colle avec un peigne cranté adéquat et poser la mosaïque Jasba. Le jointoiement peut être effectué au plus tôt après 24 heures avec un mortier de joint approprié.

Attention :

La pose correcte de nos produits n'est pas de notre ressort. Par conséquent, il n'est pas possible d'endosser une quelconque responsabilité pour l'application de nos produits dans le cadre de nos conditions générales de vente (à consulter sur www.jasba.de/impressum.html), celle-ci ne portant que sur leur qualité. Sous réserve de modifications dans le cadre du progrès technique.

Vertical payloads for ceilings to DIN 1055-3 (excerpt)				
Category	Application	Examples	Distributed load Q _k (kN/m ²)	Point load Q _k (kN)
A1	Attics	Attic space to clear height of 1.8 m	1.0	1.0
A2	Residential and recreational applications	Rooms with sufficient lateral load distribution such as rooms and corridors in residential buildings, hotel rooms and hospital wards	1.5	–
A3		As for A2 but without sufficient lateral distribution	2.0	1.0
B1	Office and working areas	Corridors in office buildings, office space, doctors' surgeries, wards, recreational rooms incl. corridors, stables	2.0	2.0

Installation:

Apply suitable tile adhesive to the prepared surface in accordance with DIN EN 12004 C2 and DIN EN 12002 S1. Jasba-NIVELLA mats are cut to the required size, fully embedded in the adhesive and laid edge to edge. The tile adhesive is filled consistently in the grooves (mesh structure). The mesh cavities must be 100% filled. Using the corresponding toothed bar, comb out the adhesive and lay the Jasba mosaics. At the earliest after 24 hours, the areas are grouted using a polymer-modified mortar.

Attention:

The correct and therefore successful application of our products is beyond our control. A guarantee can therefore only be given for the quality of our products within the framework of our terms and conditions governing sale and delivery (please refer to www.jasba.de/impressum.html) but not for successful installation thereof. We retain the right to modifications representing technical progress.



Studioaufnahme · photo prise en studio · studio photo / Architekt · architecte · architect: VSBL, Belgrad, Serbien · Belgrade, Serbie · Belgrade, Serbia /
Serie · série · series: Kiano / Photo: Jochen Stüber



Leichtigkeit, Kraft und Vergnügen

Inspiriert von afrikanischer Handwerkskunst wirkt die Serie Kiano beschwingt und kraftvoll zugleich. Eine Mischung aus Stein und Zement, die durch den Wechsel von ruhigen Elementen und markanten Äderungen geprägt ist, bildet die Basis der Serie. Die trittsicheren Bodenfliesen stehen in zwei Formaten und vier Farbtönen zur Verfügung. Assoziationen an jahrhundertealte Höhlenmalerei weckt die leicht reliefierte Wandfliese „Stroke“, die ebenfalls als Riegelformat erhältlich ist. Die Mosaikmatte „Chess“ im Schachbrettmuster besticht durch ihre handwerkliche Linie. Das Mosaik „Messing“ taucht das afrikanische Muster in einen metallischen Glanz und rundet die Serie ab.

Légèreté, force et plaisir

Inspirée de l'art artisanal africain, la gamme Kiano regorge de vitalité et d'énergie. Un mélange de pierre et de ciment marqué par l'alternance d'éléments apaisés et d'un veinage plus prononcé constituent la base de cette gamme. Les carreaux de sol antidérapants sont proposés en deux formats et quatre teintes différentes. Également disponible en format bandeau, le carreau de mur « Stroke », au relief filigrane, est inspiré de peintures rupestres séculaires. La mosaïque sur trame « Chess » au motif de damier séduit par son aspect artisanal. La mosaïque « laiton » qui confère au motif africain une aura métallique vient avantageusement compléter la gamme.

Lightness, power and pleasure

Inspired by traditional African art, the Kiano range is both lively and powerful. It is based on a combination of stone and cement characterised by the transformation from calm elements and distinctive changes. The non-slip floor tiles are available in two formats and four colors. Associations with centuries-old cave drawings are intimated by the slightly moulded "Stroke" wall tile which is also available in strip format. The "Chess" mosaic mat in a checkerboard pattern is distinctive through its artisanal contours. The "brass" mosaic attributes the African pattern a metallic sheen and rounds off the range.

Art.	Nennmaß cote nominale nominal size cm	Herstellmaß cote de fabrication production size mm	m ²	Paket carton box	Palette palette pallet	Beanspr.-Gruppe groupe d'emploi wear resist. group	Norm Norme Standard	Trittsicherheit antidérapance non-slip	Preisgruppe groupe de prix price category
283106H	30 x 60	297 x 597 x 9	5,556 St pc	9 St pc	77,754 m ²		BIII GL		W63 (m ²)
283107H			14,946 kg	1,620 m ² 24,210 kg	1.162,080 kg		BIII GL		W63 (m ²)
363360H	35 x 100	347 x 997 x 6	2,857 St pc	5 St pc	70,000 m ²		BIII GL		W124 (m ²)
363361H			10,513 kg	1,750 m ² 18,400 kg	736,000 kg		BIII GL		W124 (m ²)

Wandfliese | carreau de mur | wall tile

Steingut glasiert | faïence émaillée | earthenware glazed

30 x 60 cm



283106H

sand weiß | blanc sable | sand-white
seidenmatt, eben | satinée, lisse | silky-glossy, smooth



30 x 60 cm



283107H

Stroke
sand weiß | blanc sable | sand-white
seidenmatt, eben | satinée, lisse | silky-glossy, smooth



35 x 100 cm



363360H

sand weiß | blanc sable | sand-white
seidenmatt, eben | satinée, lisse | silky-glossy, smooth

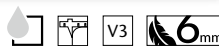

35 x 100 cm



363361H

Stroke
sand weiß | blanc sable | sand-white
seidenmatt, eben | satinée, lisse | silky-glossy, smooth

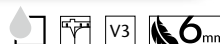

Art.	Nennmaß cote nominale nominal size cm	Herstellmaß cote de fabrication production size mm	m	Paket carton box	Palette palette pallet	Beanspr.-Gruppe groupe d'emploi wear resist. group	Norm Norme Standard	Trittsicherheit antidérapance non-slip	Preisgruppe groupe de prix price category
431946							Bla UGL	R10/A	W571 (St pc)
431947	30 x 30	297 x 297 x 10,5	3,333 St pc	2 St pc			Bla UGL	R10/A	W571 (St pc)
431948			5,123 kg	0,600 m	3,074 kg		Bla UGL	R10/A	W571 (St pc)
431949							Bla UGL	R10/A	W571 (St pc)
363362 NEW							Bla UGL	R10/A	W571 (St pc)
363363 NEW	30 x 30	297 x 297 x 6	3,333 St pc	3 St pc			Bla UGL	R10/A	W571 (St pc)
363364 NEW			2,926 kg	0,900 m	2,634 kg		Bla UGL	R10/A	W571 (St pc)
363365 NEW							Bla UGL	R10/A	W571 (St pc)

Dekorationselemente | éléments décoratifs | decoration elements

Mosaikmatte Chess | mosaïque Chess | mosaic sheet Chess

Feinsteinzeugfliesen unglasiert | grès cérame fin vitrifié non-émaillés | porcelain stoneware tiles unglazed

30 x 30 cm



431946
elfenbein weiß, strukturiert,
mit Glanzapplikation
blanc ivoire, structuré,
avec application brillante
ivory-white, structured,
with gloss application



431947
sahara beige, strukturiert,
mit Glanzapplikation
sahara beige, structuré,
avec application brillante
sahara beige, structured,
with gloss application

363363
sahara beige, strukturiert,
mit Glanzapplikation
sahara beige, structuré,
avec application brillante
sahara beige, structured,
with gloss application



431948
atlas grau, strukturiert,
mit Glanzapplikation
gris atlas, structuré,
avec application brillante
atlas grey, structured,
with gloss application



431949
kohleschwarz, strukturiert,
mit Glanzapplikation
noir carbone, structuré,
avec application brillante
coal-black, structured,
with gloss application

363365
kohleschwarz, strukturiert,
mit Glanzapplikation
noir carbone, structuré,
avec application brillante
coal-black, structured,
with gloss application

Abgabe der Dekorationselemente ausschließlich in vollen Kartons.
Éléments décoratifs uniquement livrables en cartons entiers.
Decoration elements only available in full boxes.

Mosaik, Verklebung rückseitig auf
Glasfasernetz, Bogen: 297 x 297 mm.

Mosaïque, collée sur trame en fibre de
verre à l'envers, Feuille: 297 x 297 mm.

Mosaic, glass fibre net on reverse side,
Sheet: 297 x 297 mm.

Art.	Nennmaß cote nominale nominal size cm	Herstellmaß cote de fabrication production size mm	m ² /m	Paket carton box	Palette palette pallet	Beanspr.-Gruppe groupe d'emploi wear resist. group	Norm Norme Standard	Trittsicherheit antidérapance non-slip	Preisgruppe groupe de prix price category
283110H	10 x 25	97 x 247 x 9	40 St pc / m ²	20 St pc	64,000 m ²		Bib GL		W130 (m²)
283111H			19,000 kg	0,500 m ² 9,500 kg	1.216,000 kg		Bib GL		W130 (m²)
363366H <small>NEW</small>	10 x 25	97 x 247 x 6	40 St pc / m ²	30 St pc	96,000 m ²		Bib GL		W130 (m²)
363367H <small>NEW</small>			12,640 kg	0,750 m ² 9,480 kg	1.213,440 kg		Bib GL		W130 (m²)
283112H	5 x 5	47 x 47 x 6,5	3,333 St pc / m	11 St pc			Bib GL		W448 (St pc)
			3,736 kg	3,300 m	12,331 kg				

Dekorationselemente | éléments décoratifs | decoration elements

Dekorfliese Stroke | carreau décoratif Stroke | decorative element Stroke

Steinzeug glasiert | grès émaillé | stoneware glazed

10 x 25 cm



283110H   

light, strukturiert,
mit Glanzapplikation
light, structuré,
avec application brillante
light, structured,
with gloss application

363366H    

light, strukturiert,
mit Glanzapplikation
light, structuré,
avec application brillante
light, structured,
with gloss application



283111H   

dark, strukturiert,
mit Glanzapplikation
dark, structuré,
avec application brillante
dark, structured,
with gloss application

363367H    

dark, strukturiert,
mit Glanzapplikation
dark, structuré,
avec application brillante
dark, structured,
with gloss application

Nur für die Verlegung an der Wand geeignet.
Convient uniquement pour une pose murale.
Only suitable for laying on the wall.

Mosaikmatte Messing | mosaïque laiton | mosaic sheet brass

Steinzeug glasiert | grès émaillé | stoneware glazed

5 x 5 cm



Mosaik, Verklebung rückseitig auf
Glasfasernetz, Bogen: 297 x 297 mm.
Nur für die Verlegung an der Wand
geeignet.

Mosaïque, collée sur trame en fibre de
verre à l'envers, Feuille: 297 x 297 mm.
Convient uniquement pour une pose
murale.

Mosaic, glass fibre net on reverse side,
Sheet: 297 x 297 mm. Only suitable for
laying on the wall.

283112H    

messing, strukturiert,
mit Glanzapplikation
laiton, structuré,
avec application brillante
brass, structured,
with gloss application

Abgabe der Dekorationselemente ausschließlich in vollen Kartons.
Éléments décoratifs uniquement livrables en cartons entiers.
Decoration elements only available in full boxes.

Art.	Nennmaß cote nominale nominal size cm	Herstellmaß cote de fabrication production size mm	m ²	Paket carton box	Palette palette pallet	Beanspr.-Gruppe groupe d'emploi wear resist. group	Norm Norme Standard	Trittsicherheit antidérapance non-slip	Preisgruppe groupe de prix price category
431930							Bla UGL	R10/A	W72 (m ²)
431931	30 x 60	297 x 597 x 10,5	5,556 St pc	6 St pc	43,197 m ²		Bla UGL	R10/A	W72 (m ²)
431932			23,224 kg	1,080 m ² 25,080 kg	1.003,200 kg		Bla UGL	R10/A	W72 (m ²)
431933							Bla UGL	R10/A	W72 (m ²)
431934							Bla UGL	R10/A	W84 (m ²)
431935	60 x 60	597 x 597 x 10,5	2,778 St pc	3 St pc	38,877 m ²		Bla UGL	R10/A	W84 (m ²)
431936			23,769 kg	1,080 m ² 25,668 kg	924,048 kg		Bla UGL	R10/A	W84 (m ²)
431937							Bla UGL	R10/A	W84 (m ²)

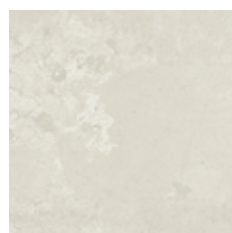

elfenbein weiß
blanc ivoire
ivory-white



sahara beige



atlas grau
gris atlas
atlas grey



kohleschwarz
noir carbone
coal-black



Bodenfliese | carreau de sol | floor tile

Feinsteinzeugfliesen unglasiert | grès cérame fin vitrifié non-émaillés | porcelain stoneware tiles unglazed

30 x 60 cm



431930

elfenbein weiß, strukturiert, mit Glanzapplikation
blanc ivoire, structuré, avec application brillante
ivory-white, structured, with gloss application

431931

sahara beige, strukturiert, mit Glanzapplikation
sahara beige, structuré, avec application brillante
sahara beige, structured, with gloss application

431932

atlas grau, strukturiert, mit Glanzapplikation
gris atlase, structuré, avec application brillante
atlas grey, structured, with gloss application

431933

kohleschwarz, strukturiert, mit Glanzapplikation
noir carbone, structuré, avec application brillante
coal-black, structured, with gloss application

60 x 60 cm



431934

elfenbein weiß, strukturiert, mit Glanzapplikation
blanc ivoire, structuré, avec application brillante
ivory-white, structured, with gloss application

431935

sahara beige, strukturiert, mit Glanzapplikation
sahara beige, structuré, avec application brillante
sahara beige, structured, with gloss application

431936

atlas grau, strukturiert, mit Glanzapplikation
gris atlase, structuré, avec application brillante
atlas grey, structured, with gloss application

431937

kohleschwarz, strukturiert, mit Glanzapplikation
noir carbone, structuré, avec application brillanten
coal-black, structured, with gloss application

Art.	Nennmaß cote nominale nominal size cm	Herstellmaß cote de fabrication production size mm	m	Paket carton box	Palette palette pallet	Beanspr.-Gruppe groupe d'emploi wear resist. group	Norm Norme Standard	Trittsicherheit antidérapance non-slip	Preisgruppe groupe de prix price category
431938							Bla UGL	R10/A	W473 (St pc)
431939	30 x 60	297 x 597 x 10,5	1,667 St pc	6 St pc			Bla UGL	R10/A	W473 (St pc)
431940			6,968 kg	3,599 m	25,080 kg		Bla UGL	R10/A	W473 (St pc)
431941							Bla UGL	R10/A	W473 (St pc)
431942							Bla UGL		W439 (St pc)
431943	7 x 60	70 x 597 x 10,5	1,667 St pc	22 St pc			Bla UGL		W439 (St pc)
431944			1,717 kg	13,197 m	22,660 kg		Bla UGL		W439 (St pc)
431945							Bla UGL		W439 (St pc)



elfenbein weiß
blanc ivoire
ivory-white

V4



sahara beige

V4



atlas grau
gris atlas
atlas grey

V4



kohleschwarz
noir carbone
coal-black

V4

Treppenfliese | nez de marche | stair tile

Feinsteinzeugfliesen unglasiert | grès cérame fin vitrifié non-émaillés | porcelain stoneware tiles unglazed

30 x 60 cm



431938

elfenbein weiß, strukturiert, mit Glanzapplikation
blanc ivoire, structuré, avec application brillante
ivory-white, structured, with gloss application

431939

sahara beige, strukturiert, mit Glanzapplikation
sahara beige, structuré, avec application brillante
sahara beige, structured, with gloss application

431940

atlas grau, strukturiert, mit Glanzapplikation
gris atlas, structuré, avec application brillante
atlas grey, structured, with gloss application

431941

kohleschwarz, strukturiert, mit Glanzapplikation
noir carbone, structuré, avec application brillante
coal-black, structured, with gloss application

Auftragsfertigung: Rückgabe und/oder Stornierung
bestellter Ware nicht möglich.

Fabrication sur commande : il nous est impossible d'accepter
l'annulation de commandes d'articles ou le retour d'articles.

Make-to-order production: return and/or cancellation
of ordered products not possible.

Sockel, geschnitten | plinthe, à bord vif | skirting, cut

Feinsteinzeugfliesen unglasiert | grès cérame fin vitrifié non-émaillés | porcelain stoneware tiles unglazed

7 x 60 cm



431942

elfenbein weiß, strukturiert, mit Glanzapplikation
blanc ivoire, structuré, avec application brillante
ivory-white, structured, with gloss application

431943

sahara beige, strukturiert, mit Glanzapplikation
sahara beige, structuré, avec application brillante
sahara beige, structured, with gloss application

431944

atlas grau, strukturiert, mit Glanzapplikation
gris atlas, structuré, avec application brillante
atlas grey, structured, with gloss application

431945

kohleschwarz, strukturiert, mit Glanzapplikation
noir carbone, structuré, avec application brillante
coal-black, structured, with gloss application

Art.	Nennmaß cote nominale nominal size cm	Herstellmaß cote de fabrication production size mm	m ²	Paket carton box	Palette palette pallet	Beanspr.-Gruppe groupe d'emploi wear resist. group	Norm Norme Standard	Trittsicherheit antidérapance non-slip	Preisgruppe groupe de prix price category
431950H							Bla UGL	R10/B	W151 (m ²)
431951H	5 x 5	47 x 47 x 6,5	11 Bögen plaques sheets	11 Bögen plaques sheets	64,000 m ²		Bla UGL	R10/B	W151 (m ²)
431952H			12,331 kg	1,000 m ² 12,331 kg	789,184 kg		Bla UGL	R10/B	W151 (m ²)
431953H							Bla UGL	R10/B	W151 (m ²)

Mosaik | mosaïque | mosaic

Feinsteinzeugfliesen unglasiert | grès cérame fin vitrifié non-émaillés | porcelain stoneware tiles unglazed

5 x 5 cm



431950H

elfenbein weiß, strukturiert, mit Glanzapplikation
blanc ivoire, structuré, avec application brillante
ivory-white, structured, with gloss application



431951H

sahara beige, strukturiert, mit Glanzapplikation
sahara beige, structuré, avec application brillante
sahara beige, structured, with gloss application



431952H

atlas grau, strukturiert, mit Glanzapplikation
gris atlas, structuré, avec application brillante
atlas grey, structured, with gloss application

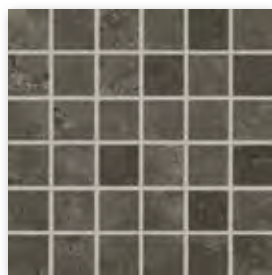

431953H

kohleschwarz, strukturiert, mit Glanzapplikation
noir carbone, structuré, avec application brillante
coal-black, structured, with gloss application

Mosaik, rückseitig thermoplastisch verklebt
Bogen: 297 x 297 mm

Mosaïque, collage thermoplastique sur l'envers
Feuille: 297 x 297 mm

Mosaic, glued thermo-plastically on back
Sheet: 297 x 297 mm

Elegant und vertraut

La Casa kann mit ihren klassischen Grundfarben in unterschiedlichen Stilwelten eingesetzt werden. Alle Wandfliesen sind durch die Hytect-Oberfläche besonders reinigungsfreundlich. Mit Bordüren und farblich abgestimmten Stäbchenmosaiken bietet die Serie einen kleinen Baukasten an Wand- und Dekorationselementen für vielseitige Gestaltungen – zeitlos und dezent.

Élégante et familière

Avec ses couleurs de base classiques, La Casa peut être utilisée dans différents univers de style. Tous les carreaux de mur sont particulièrement faciles à nettoyer grâce à la surface Hytect. Avec des bordures et des mosaïques de baguettes aux couleurs assorties, la série offre un petit kit de construction d'éléments muraux et décoratifs pour des designs polyvalents – hors temps et discrets.

Elegant and familiar

With its classic basic colours, La Casa can be used in different style worlds. All wall tiles are particularly easy to clean thanks to the Hytect surface. With borders and rod mosaics in matching colours, the series offers a small modular system of wall and decorative elements for versatile designs – timeless and discreet.





Art.	Nennmaß cote nominale nominal size cm	Herstellmaß cote de fabrication production size mm	m ²	Paket carton box	Palette palette pallet	Beanspr.-Gruppe groupe d'emploi wear resist. group	Norm Norme Standard	Trittsicherheit antidérapance non-slip	Preisgruppe groupe de prix price category
182105H							BIII GL		B41 (m ²)
182106H	20 x 40	197 x 397 x 7,5	12,500 St pc	16 St pc	92,160 m ²		BIII GL		B41 (m ²)
182818H			12,638 kg	1,280 m ² 16,176 kg	1.164,672 kg		BIII GL		B41 (m ²)
182821H							BIII GL		B41 (m ²)
382819H	20 x 60	197 x 597 x 9	8,333 St pc	8 St pc	61,442 m ²		BIII GL		B55 (m ²)
382822H			15,516 kg	0,960 m ² 14,896 kg	953,344 kg		BIII GL		B55 (m ²)

Wandfliese | carreau de mur | wall tile

Steingut glasiert | faïence émaillée | earthenware glazed

20 x 40 cm

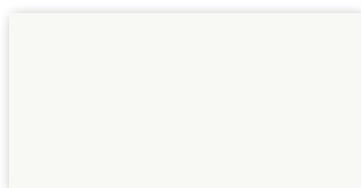

182105H

weiß | blanc | white
seidenmatt, eben | satinée, lisse | silky-glossy, smooth

182106H

weiß | blanc | white
glänzend, eben | brillant, lisse | glossy, smooth



182818H

hellgrau | gris clair | light-grey
seidenmatt, eben | satinée, lisse | silky-glossy, smooth

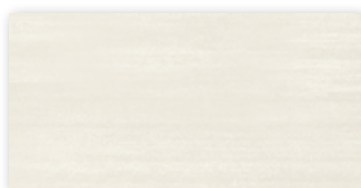

182821H

naturbeige | beige nature | natural-beige
seidenmatt, eben | satinée, lisse | silky-glossy, smooth

20 x 60 cm

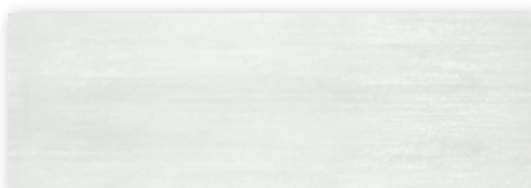

382819H

hellgrau | gris clair | light-grey
seidenmatt, eben | satinée, lisse | silky-glossy, smooth

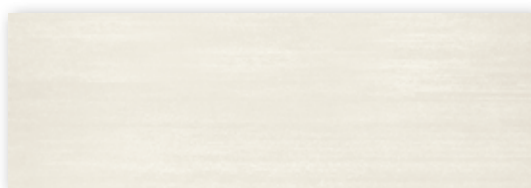

382822H

naturbeige | beige nature | natural-beige
seidenmatt, eben | satinée, lisse | silky-glossy, smooth

Art.	Nennmaß cote nominale nominal size cm	Herstellmaß cote de fabrication production size mm	m ²	Paket carton box	Palette palette pallet	Beanspr.-Gruppe groupe d'emploi wear resist. group	Norm Norme Standard	Trittsicherheit antidérapance non-slip	Preisgruppe groupe de prix price category
282813H							BIII GL		B55 (m ²)
282814H							BIII GL		B55 (m ²)
282815H	30 x 60	297 x 597 x 9	5,556 St pc	9 St pc	77,754 m ²		BIII GL		B55 (m ²)
282817H			14,946 kg	1,620 m ² 24,210 kg	1.162,080 kg		BIII GL		B55 (m ²)
282820H							BIII GL		B55 (m ²)
282823H							BIII GL		B55 (m ²)

Wandfliese | carreau de mur | wall tile
Steingut glasiert | faïence émaillée | earthenware glazed

30 x 60 cm

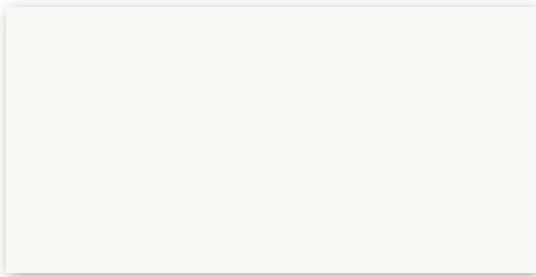

282813H
weiß | blanc | white
seidenmatt, eben | satinée, lisse | silky-glossy, smooth



282820H
hellgrau | gris clair | light-grey
seidenmatt, eben | satinée, lisse | silky-glossy, smooth

282814H
weiß | blanc | white
glänzend, eben | brillant, lisse | glossy, smooth

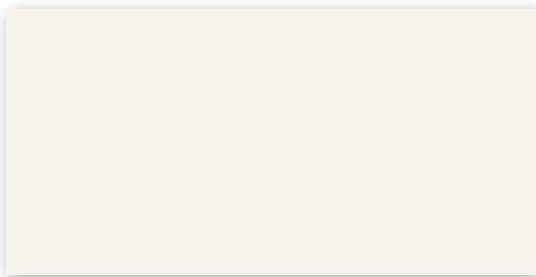

282815H
hellbeige | beige clair | light-beige
glänzend, eben | brillant, lisse | glossy, smooth

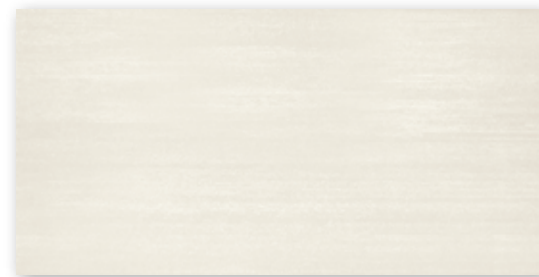

282823H
naturbeige | beige nature | natural-beige
seidenmatt, eben | satinée, lisse | silky-glossy, smooth

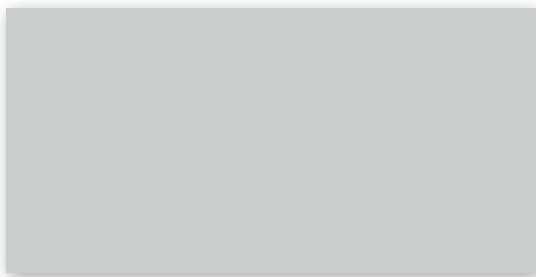

282817H
grau | gris | grey
glänzend, eben | brillant, lisse | glossy, smooth

Art.	Nennmaß cote nominale nominal size cm	Herstellmaß cote de fabrication production size mm	m ²	Paket carton box	Palette palette pallet	Beanspr.-Gruppe groupe d'emploi wear resist. group	Norm Norme Standard	Trittsicherheit antidérapance non-slip	Preisgruppe groupe de prix price category
283073H							BIII GL	B55 (m²)	
283074H	30 x 60	297 x 597 x 9	5,556 St pc	9 St pc	77,754 m ²		BIII GL	B55 (m²)	
283075H			14,946 kg	1,620 m ² 24,210 kg	1.162,080 kg		BIII GL	B55 (m²)	
283076H							BIII GL	B55 (m²)	

Wandfliese | carreau de mur | wall tile

Steingut glasiert | faïence émaillée | earthenware glazed

30 x 60 cm

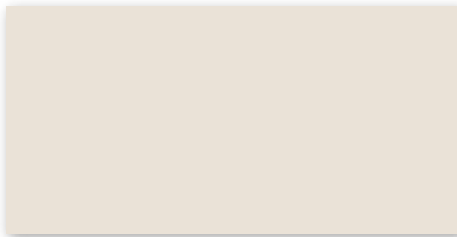

283073H

desert sand | sable désert| desert sand
glänzend, eben | brillant, lisse | glossy, smooth

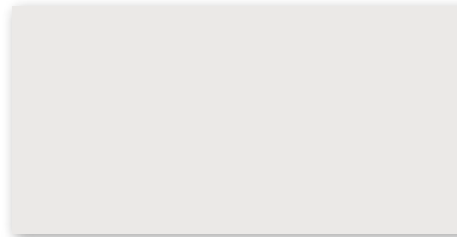

283075H

light grey | gris clair| light grey
glänzend, eben | brillant, lisse | glossy, smooth



283074H

taupe | taupe| taupe
glänzend, eben | brillant, lisse | glossy, smooth



283076H

medium grey | gris moyen| medium grey
glänzend, eben | brillant, lisse | glossy, smooth

Art.	Nennmaß cote nominale nominal size cm	Herstellmaß cote de fabrication production size mm	m	Paket carton box	Palette palette pallet	Beanspr.-Gruppe groupe d'emploi wear resist. group	Norm Norme Standard	Trittsicherheit antidérapance non-slip	Preisgruppe groupe de prix price category
182825	3,7 x 40	37 x 397 x 8	2,500 St pc	5 St pc			Alb UGL		B437 (St pc)
182827			0,645 kg	2,000 m	1,290 kg		Alb UGL		B437 (St pc)
282824	3,7 x 60	37 x 597 x 10,5	1,667 St pc	3 St pc			Alb UGL		B437 (St pc)
282826			0,845 kg	1,800 m	1,521 kg		Alb UGL		B437 (St pc)
182125							Alb UGL	R9	B491 (St pc)
182126	30 x 30	297 x 297 x 8	3,333 St pc	11 St pc			Alb UGL	R9	B491 (St pc)
182127			5,333 kg	3,300 m	17,600 kg		Alb UGL	R9	B491 (St pc)

Dekorationselemente | éléments décoratifs | decoration elements

Bordüre | bordure | border

Feinsteinzeugfliesen unglasiert | grès cérame fin vitrifié non-émaillés | porcelain stoneware tiles unglazed

3,7 x 40 cm



182825

basalt metallic | basalte métallisé | basalt metallic
eben, matt | lisse, mat | smooth, matt

3,7 x 60 cm



282824

basalt metallic | basalte métallisé | basalt metallic
eben, matt | lisse, mat | smooth, matt

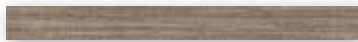

182827

schlamm-braun metallic | brun boue métallisé | mud-brown metallic
eben, matt | lisse, mat | smooth, matt

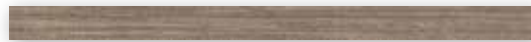

282826

schlamm-braun metallic | brun boue métallisé | mud-brown metallic
eben, matt | lisse, mat | smooth, matt



Dekorationselemente | éléments décoratifs | decoration elements

Mosaik | mosaïque | mosaic

Feinsteinzeugfliesen unglasiert | grès cérame fin vitrifié non-émaillés | porcelain stoneware tiles unglazed

30 x 30 cm



182125

beige-braun-Mix
mélange beige-brun
beige-brown mix
eben, matt | lisse, mat | smooth, matt

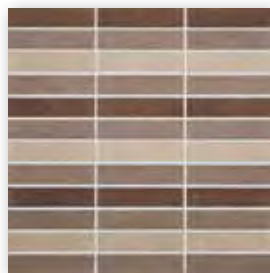

182126

braun-Mix
mélange brun
brown mix
eben, matt | lisse, mat | smooth, matt



182127

grau-Mix
mélange gris
grey mix
eben, matt | lisse, mat | smooth, matt



Mosaik, Verklebung rückseitig
auf Glasfasernetz, Bogen: 297 x 297 mm
Mosaïque, collée sur trame en fibre
de verre à l'envers, Feuille : 297 x 297 mm
Mosaic, glass fibre net on reverse side,
Sheet: 297 x 297 mm

Abgabe der Dekorationselemente ausschließlich in vollen Kartons.
Éléments décoratifs uniquement livrables en cartons entiers.
Decoration elements only available in full boxes.





Fliesen für Lebensräume

Fliesen für Lebensräume – privates Wohnen, Gastronomie & Hotellerie oder öffentliche Gebäude in denen das Wohlfühlen im Vordergrund steht. Räume in denen man sich gerne aufhält. Like ist eine Fliesenkollektion, die dafür gemacht ist, im Zusammenspiel mit anderen Materialien ein perfektes Ganzes zu ergeben. Die Optik ist dezent lebendig – feine Unregelmäßigkeiten geben den Fliesen ihren unverwechselbaren Charakter und bringen jede der 5 Farben perfekt zur Geltung. Ob Mosaik oder Großformat, die Serie Like entfaltet immer ihren vollen Charme – sowohl im Raum als auch auf der Terrasse.

Les carreaux pour les espaces de vie

Les carreaux pour les espaces de vie – habitat privé, gastronomie et hôtellerie ou bâtiments publics dans lesquels l'accent est mis sur le bien-être. Des locaux dans lesquels on aime passer du temps. Like est une collection de carreaux faite pour créer un ensemble parfait lorsqu'elle est combinée avec d'autres matériaux. L'aspect est décentement vivant – de fines irrégularités donnent aux carreaux leur caractère unique et font ressortir chacune des 5 couleurs à la perfection. Qu'elle soit en mosaïque ou en grand format, la série Like déploie toujours tout son charme – tant dans la pièce qu'en terrasse.

Tiles for living spaces

Tiles for living spaces – private living, gastronomy & hotels or public buildings in which the focus is on well-being. Rooms in which one likes to spend time. LIKE is a tile collection that is made to create a perfect whole in combination with other materials. The look is discreetly lively – fine irregularities give the tiles their unmistakable character and bring out each of the 5 colors perfectly. Whether mosaic or large format, the LIKE series always unfolds its full charm – both in the room and on the terrace.

Art.	Nennmaß cote nominale nominal size cm	Herstellmaß cote de fabrication production size mm	m ²	Paket carton box	Palette palette pallet	Beanspr.-Gruppe groupe d'emploi wear resist. group	Norm Norme Standard	Trittsicherheit antidérapance non-slip	Preisgruppe groupe de prix price category
430645							Bla UGL	R10/A+B	W72 (m ²)
430646							Bla UGL	R10/A+B	W72 (m ²)
430647	30 x 60	297 x 596 x 9	5,556 St pc	7 St pc	50,396 m ²		Bla UGL	R10/A+B	W72 (m ²)
430648			19,841 kg	1,260 m ² 25,000 kg	999,880 kg		Bla UGL	R10/A+B	W72 (m ²)
430649							Bla UGL	R10/A+B	W72 (m ²)
430650							Bla UGL	R10/A+B	W84 (m ²)
430651							Bla UGL	R10/A+B	W84 (m ²)
430652	60 x 60	596 x 596 x 9	2,778 St pc	3 St pc	43,197 m ²		Bla UGL	R10/A+B	W84 (m ²)
430653			19,288 kg	1,080 m ² 20,829 kg	833,160 kg		Bla UGL	R10/A+B	W84 (m ²)
430654							Bla UGL	R10/A+B	W84 (m ²)

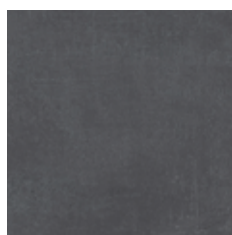

graphite



ash grey



cement



warm grey



off white



Bodenfliese | carreau de sol | floor tile

Feinsteinzeugfliesen unglasiert | grès cérame fin vitrifié non-émaillés | porcelain stoneware tiles unglazed

30 x 60 cm



430645
graphite
strukturiert, matt
structuré, mat
structured, matt



430646
ash grey
strukturiert, matt
structuré, mat
structured, matt

430648
warm grey
strukturiert, matt
structuré, mat
structured, matt

430647
cement
strukturiert, matt
structuré, mat
structured, matt

430649
off white
strukturiert, matt
structuré, mat
structured, matt

60 x 60 cm



430650
graphite
strukturiert, matt
structuré, mat
structured, matt

430651
ash grey
strukturiert, matt
structuré, traité
structured, matt

430652
cement
strukturiert, matt
structuré, mat
structured, matt

430653
warm grey
strukturiert, matt
structuré, mat
structured, matt

430654
off white
strukturiert, matt
structuré, mat
structured, matt



Art.	Nennmaß cote nominale nominal size cm	Herstellmaß cote de fabrication production size mm	m ²	Paket carton box	Palette palette pallet	Beanspr.-Gruppe groupe d'emploi wear resist. group	Norm Norme Standard	Trittsicherheit antidérapance non-slip	Preisgruppe groupe de prix price category
430655							Bla UGL	R10/A+B	W130 (m ²)
430656							Bla UGL	R10/A+B	W130 (m ²)
430657	80 x 80	795 x 795 x 9	1,563 St pc	2 St pc	61,420 m ²		Bla UGL	R10/A+B	W130 (m ²)
430658			21,381 kg	1,280 m ²	27,360 kg		Bla UGL	R10/A+B	W130 (m ²)
430659							Bla UGL	R10/A+B	W130 (m ²)

Bodenfliese | carreau de sol | floor tile*

Feinsteinzeugplatten unglasiert | grès fin non-émaillés | porcelain stoneware tiles unglazed

80 x 80 cm



430655

graphite
strukturiert, matt
structuré, mat
structured, matt

430656

ash grey
strukturiert, matt
structuré, mat
structured, matt

430657

cement
strukturiert, matt
structuré, mat
structured, matt

430658

warm grey
strukturiert, matt
structuré, mat
structured, matt

430659

off white
strukturiert, matt
structuré, mat
structured, matt



* Achtung: Sonderpalette. Keine Rücknahme, kein Umtausch.

* Attention : palette spéciale. Pas de retour, pas d'échange.

* Please note: special pallet. No return, no exchange.

Art.	Nennmaß cote nominale nominal size cm	Herstellmaß cote de fabrication production size mm	m ²	Paket carton box	Palette palette pallet	Beanspr.-Gruppe groupe d'emploi wear resist. group	Norm Norme Standard	Trittsicherheit antidérapance non-slip	Preisgruppe groupe de prix price category
430660							Bla UGL	R10/A+B	W161 (m ²)
430661							Bla UGL	R10/A+B	W161 (m ²)
430662	120 x 120	1194 x 1194 x 9	0,694 St pc	2 St pc	57,637 m ²		Bla UGL	R10/A+B	W161 (m ²)
430663			21,098 kg	2,882 m ²	60,800 kg		Bla UGL	R10/A+B	W161 (m ²)
430664							Bla UGL	R10/A+B	W161 (m ²)



graphite



ash grey



cement



warm grey



off white



Bodenfliese | carreau de sol | floor tile*/**

Feinsteinzeugfliesen unglasiert | grès cérame fin vitrifié non-émaillés | porcelain stoneware tiles unglazed

120 x 120 cm



430660
graphite
strukturiert, matt
structuré, mat
structured, matt

430661
ash grey
strukturiert, matt
structuré, mat
structured, matt

430662
cement
strukturiert, matt
structuré, mat
structured, matt

430663
warm grey
strukturiert, matt
structuré, mat
structured, matt

430664
off white
strukturiert, matt
structuré, mat
structured, matt

* Achtung: Sonderpalette. Keine Rücknahme, kein Umtausch.
* Attention : palette spéciale. Pas de retour, pas d'échange.
* Please note: special pallet. No return, no exchange.

** Hohes Gewicht! Karton bitte nur zu Zweit transportieren.
** Poids élevé ; a transporter par deux personnes seulement.
** High weight only to carry with two persons.

Art.	Nennmaß cote nominale nominal size cm	Herstellmaß cote de fabrication production size mm	m ²	Paket carton box	Palette palette pallet	Beanspr.-Gruppe groupe d'emploi wear resist. group	Norm Norme Standard	Trittsicherheit antidérapance non-slip	Preisgruppe groupe de prix price category
430640							Bla UGL	R10/A+B	W288 (m ²)
430641							Bla UGL	R10/A+B	W288 (m ²)
430642	5 x 5	47 x 47 x 9	11,111 Bögen plaques sheets	12 Bögen plaques sheets	32,400 m ²		Bla UGL	R10/A+B	W288 (m ²)
430643			19,833 kg	1,080 m ² 21,420 kg	642,600 kg		Bla UGL	R10/A+B	W288 (m ²)
430644							Bla UGL	R10/A+B	W288 (m ²)

Mosaik | mosaïque | mosaic

Feinsteinzeugfliesen unglasiert | grès cérame fin vitrifié non-émaillés | porcelain stoneware tiles unglazed

5 x 5 cm

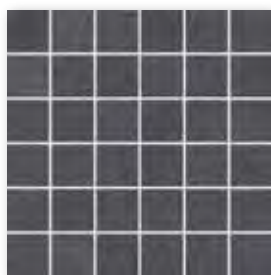

430640
graphite
strukturiert, matt
structuré, mat
structured, matt



430641
ash grey
strukturiert, matt
structuré, mat
structured, matt



430642
cement
strukturiert, matt
structuré, mat
structured, matt



430643
warm grey
strukturiert, matt
structuré, mat
structured, matt



430644
off white
strukturiert, matt
structuré, mat
structured, matt

Mosaik, Verklebung rückseitig auf Glasfasernetz
Bogen: 297 x 297 mm

Mosaïque, collée sur trame en fibre de verre à
l'envers, Feuille: 297 x 297 mm

Mosaic, glass fibre net on reverse side
Sheet: 297 x 297 mm

Art.	Nennmaß cote nominale nominal size cm	Herstellmaß cote de fabrication production size mm	m	Paket carton box	Palette palette pallet	Beanspr.-Gruppe groupe d'emploi wear resist. group	Norm Norme Standard	Trittsicherheit antidérapance non-slip	Preisgruppe groupe de prix price category
430635							Bla UGL	R10/A+B	W515 (St pc)
430636							Bla UGL	R10/A+B	W515 (St pc)
430637	30 x 44,5	297 x 442 x 9	3,236 St pc	2 St pc			Bla UGL	R10/A+B	W515 (St pc)
430638			5,191 kg	0,618 m	3,208 kg		Bla UGL	R10/A+B	W515 (St pc)
430639							Bla UGL	R10/A+B	W515 (St pc)

Dekorationselemente | éléments décoratifs | decoration elements

Bordüre Tweed | bordure Tweed | border Tweed

Feinsteinzeugfliesen unglasiert | grès cérame fin vitrifié non-émaillés | porcelain stoneware tiles unglazed

30 x 44,5 cm

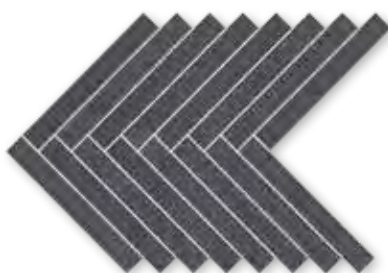

430635
graphite
strukturiert, matt
structuré, mat
structured, matt

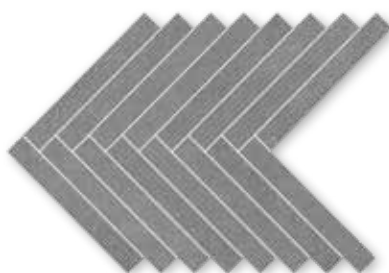

430636
ash grey
strukturiert, matt
structuré, mat
structured, matt



430637
cement
strukturiert, matt
structuré, mat
structured, matt



430638
warm grey
strukturiert, matt
structuré, mat
structured, matt



430639
off white
strukturiert, matt
structuré, mat
structured, matt

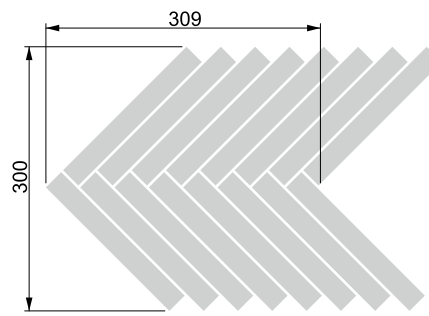

Bordüre, Verklebung rückseitig auf Glasfasernetz
Bogen: 297 x 442 mm

Border, collée sur trame en fibre de verre à
l'envers, Feuille: 297 x 442 mm

Bordure, glass fibre net on reverse side
Sheet: 297 x 442 mm

Abgabe der Dekorationselemente ausschließlich in vollen Kartons.
Éléments décoratifs uniquement livrables en cartons entiers.
Decoration elements only available in full boxes.

Art.	Nennmaß cote nominale nominal size cm	Herstellmaß cote de fabrication production size mm	m ²	Paket carton box	Palette palette pallet	Beanspr.-Gruppe groupe d'emploi wear resist. group	Norm Norme Standard	Trittsicherheit antidérapance non-slip	Preisgruppe groupe de prix price category
430665							Bla UGL	R11/B	W143 (m ²)
430666							Bla UGL	R11/B	W143 (m ²)
430667	60 x 60	596 x 596 x 20	2,778 St pc	2 St pc	21,598 m ²		Bla UGL	R11/B	W143 (m ²)
430668			47,226 kg	0,720 m ² 34,000 kg	1.020,000 kg		Bla UGL	R11/B	W143 (m ²)
430669							Bla UGL	R11/B	W143 (m ²)

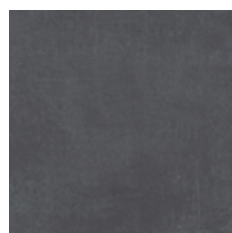

graphite



ash grey



cement



warm grey



off white



Terrassenplatte | dalle de terrasse | patio tile*

Feinsteinzeugfliesen unglasiert | grès cérame fin vitrifié non-émaillés | porcelain stoneware tiles unglazed

60 x 60 cm



430665

graphite
strukturiert, matt
structuré, mat
structured, matt

430666

ash grey
strukturiert, matt
structuré, mat
structured, matt

430667

cement
strukturiert, matt
structuré, mat
structured, matt

430668

warm grey
strukturiert, matt
structuré, mat
structured, matt



430669

off white
strukturiert, matt
structuré, mat
structured, matt

* Hohes Gewicht! Karton bitte nur zu Zweit transportieren.

* Poids élevé ; a transporter par deux personnes seulement.

* High weight only to carry with two persons.

Art.	Nennmaß cote nominale nominal size cm	Herstellmaß cote de fabrication production size mm	m ²	Paket carton box	Palette palette pallet	Beanspr.-Gruppe groupe d'emploi wear resist. group	Norm Norme Standard	Trittsicherheit antidérapance non-slip	Preisgruppe groupe de prix price category
430670	120 x 120	1194 x 1194 x 20	0,694 St pc	1 St pc	28,560 m ²		Bla UGL	R11/B	W227 (m ²)
430671			46,567 kg	1,440 m ² 67,100 kg	1.342,000 kg		Bla UGL	R11/B	W227 (m ²)



graphite



cement



Terrassenplatte | dalle de terrasse | patio tile*/**

Feinsteinzeugfliesen unglasiert | grès cérame fin vitrifié non-émaillés | porcelain stoneware tiles unglazed

120 x 120 cm



430670

graphite
strukturiert, matt
structuré, mat
structured, matt

430671

cement
strukturiert, matt
structuré, mat
structured, matt

* Achtung: Sonderpalette. Keine Rücknahme, kein Umtausch.
* Attention : palette spéciale. Pas de retour, pas d'échange.
* Please note: special pallet. No return, no exchange.

** Hohes Gewicht! Karton bitte nur zu Zweit transportieren.
** Poids élevé ; a transporter par deux personnes seulement.
** High weight only to carry with two persons.

Art.	Nennmaß cote nominale nominal size cm	Herstellmaß cote de fabrication production size mm	m	Paket carton box	Palette palette pallet	Beanspr.-Gruppe groupe d'emploi wear resist. group	Norm Norme Standard	Trittsicherheit antidérapance non-slip	Preisgruppe groupe de prix price category
430672							Bla UGL	R10/A+B	W473 (St pc)
430673							Bla UGL	R10/A+B	W473 (St pc)
430674	30 x 60	297 x 596 x 9	1,667 St pc	7 St pc			Bla UGL	R10/A+B	W473 (St pc)
430675			5,972 kg	4,199 m	25,081 kg		Bla UGL	R10/A+B	W473 (St pc)
430676							Bla UGL	R10/A+B	W473 (St pc)
430677							Bla UGL		W439 (St pc)
430678							Bla UGL		W439 (St pc)
430679	7 x 60	70 x 596 x 9	1,667 St pc	22 St pc			Bla UGL		W439 (St pc)
430680			1,357 kg	13,197 m	17,908 kg		Bla UGL		W439 (St pc)
430681							Bla UGL		W439 (St pc)



graphite



ash grey



cement



warm grey



off white



Treppenfliese | nez de marche | stair tile

Feinsteinzeugfliesen unglasiert | grès cérame fin vitrifié non-émaillés | porcelain stoneware tiles unglazed

30 x 60 cm



430672

graphite
strukturiert, matt
structuré, mat
structured, matt

430674

cement
strukturiert, matt
structuré, mat
structured, matt

430676

off white
strukturiert, matt
structuré, mat
structured, matt

430673

ash grey
strukturiert, matt
structuré, mat
structured, matt

430675

warm grey
strukturiert, matt
structuré, mat
structured, matt

Auftragsfertigung: Rückgabe
und/oder Stornierung bestellter
Ware nicht möglich.

Fabrication sur commande :
il nous est impossible d'accepter
l'annulation de commandes
d'articles ou le retour d'articles.

Make-to-order production:
return and/or cancellation of
ordered products not possible.

Sockel, gerundet | plinthe, arrondie | skirting, rounded

Feinsteinzeugfliesen unglasiert | grès cérame fin vitrifié non-émaillés | porcelain stoneware tiles unglazed

7 x 60 cm



430677

graphite
strukturiert, matt
structuré, mat
structured, matt

430679

cement
strukturiert, matt
structuré, mat
structured, matt

430681

off white
strukturiert, matt
structuré, mat
structured, matt

430678

ash grey
strukturiert, matt
structuré, mat
structured, matt

430680

warm grey
strukturiert, matt
structuré, mat
structured, matt

Unverwechselbarer Charakter

Manuell gestaltete Harzplatten sind die Ausgangsbasis der Serie Lunar. Die entstandenen unregelmäßigen Streifen geben den Fliesen ihren eigenen Ausdruck. Das Design der Basisfliesen ist schlicht mit markanten Details, so entsteht auf den Wand- und Bodenflächen (basalt, marrone, anthrazit) eine ganz besondere Optik. Ob eher reduziert oder natürlich, mit den Farbstellungen der Dekorfliese Planets als Ergänzung zu der cremegrauen Wandfliese ist beides möglich – ganz nach persönlichem Gusto.

Caractère distinctif

Les panneaux en résine conçus manuellement sont le point de départ de la série LUNAR. Les rayures irrégulières qui en résultent donnent aux carreaux leur propre expression. Le design des carreaux de base est simple avec des détails frappants, créant un aspect très spécial sur les surfaces des murs et des sols (basalte, marrone, anthracite). Les couleurs du carreau décoratif Planètes, lorsqu'il complète le carreau mural gris crème, permet les deux effets : « réduction » ou « nature » – en fonction de vos goûts personnels.

Distinctive character

Manually designed resin tiles are the starting basis for the LUNAR series. The resulting irregular stripes give the tiles their own expression. The design of the basic tiles is simple with striking details, thus creating a very special look on the wall and floor surfaces (basalt, maroon, anthracite). Whether rather reduced or natural, with the colours of the Planets decorative tile as a complement to the cream-grey wall tile, both are possible – according to personal taste.





Art.	Nennmaß cote nominale nominal size cm	Herstellmaß cote de fabrication production size mm	m ²	Paket carton box	Palette palette pallet	Beanspr.-Gruppe groupe d'emploi wear resist. group	Norm Norme Standard	Trittsicherheit antidérapance non-slip	Preisgruppe groupe de prix price category
283005	30 x 60	297 x 597 x 9	5,556 St pc 14,946 kg	9 St pc 1,620 m ² 24,210 kg	77,754 m ² 1.162,080 kg		BIII GL	B69 (m ²)	
393006	30 x 90	297 x 897 x 10,5	3,704 St pc 17,976 kg	5 St pc 1,350 m ² 24,265 kg	32,397 m ² 582,360 kg		BIII GL	B142 (m ²)	

Wandfliese | carreau de mur | wall tile

Steingut glasiert | faïence émaillée | earthenware glazed

30 x 60 cm

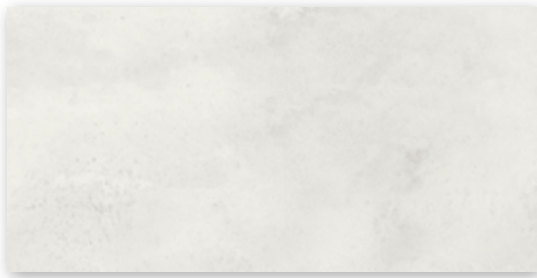

283005

cremegrau | gris crème | cream-grey
seidenmatt, eben | satiné, lisse | silky-matt, smooth

30 x 90 cm



393006

cremegrau | gris crème | cream-grey
seidenmatt, eben | satiné, lisse | silky-matt, smooth

Art.	Nennmaß cote nominale nominal size cm	Herstellmaß cote de fabrication production size mm	m	Paket carton box	Palette palette pallet	Beanspr.-Gruppe groupe d'emploi wear resist. group	Norm Norme Standard	Trittsicherheit antidérapance non-slip	Preisgruppe groupe de prix price category
283007	7,5 x 30	72 x 297 x 9	3,333 St pc	12 St pc			BIII GL		B412 (St pc)
283008			1,077 kg	3,600 m 3,876 kg			BIII GL		B412 (St pc)

Dekorationselemente | éléments décoratifs | decoration elements

Dekorfliese Planets | carreau décoratif Planets | decorative element Planets

Steingut glasiert | faïence émaillée | earthenware glazed

7,5 x 30 cm

Verlegebeispiele | modèles de pose | laying examples



Die Dekorriegel variieren bewusst in der Farbigkeit. Bitte gemischt aus mehreren Kartons verlegen, damit sich ein gleichmäßiges Bild ergibt.

La variation des couleurs des traverses décoratives est voulue. Nous recommandons de poser les carreaux en mélangeant plusieurs cartons afin d'obtenir une impression régulière.

The colors of the decoration elements Planets intentionally vary. We recommend the mixed laying of elements from several boxes in order to obtain a uniform result.

283007

weiß-grau-mix | mélange blanc gris | white-grey-mix
seidenmatt, strukturiert | satiné, structuré | silky-matt, structured

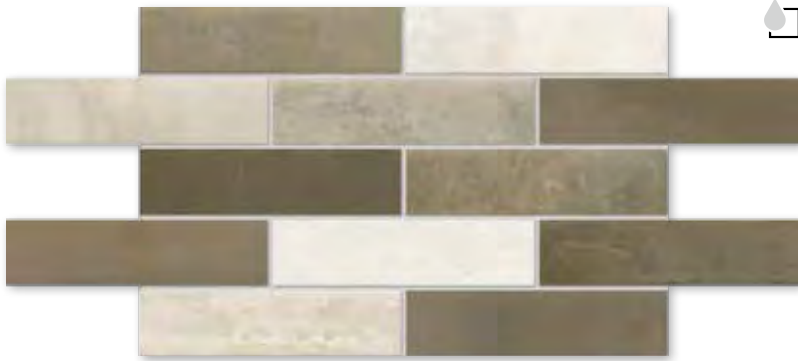

283008

beige-braun-mix | mélange beige-brun | beige-brown-mix
seidenmatt, strukturiert | satiné, structuré | silky-matt, structured

Abgabe der Dekorationselemente ausschließlich in vollen Kartons.
Éléments décoratifs uniquement livrables en cartons entiers.
Decoration elements only available in full boxes.

Art.	Nennmaß cote nominale nominal size cm	Herstellmaß cote de fabrication production size mm	m ² /m	Paket carton box	Palette palette pallet	Beanspr.-Gruppe groupe d'emploi wear resist. group	Norm Norme Standard	Trittsicherheit antidérapance non-slip	Preisgruppe groupe de prix price category
434660							Bla UGL	R9	B112 (m ²)
434661	30 x 60	297 x 596 x 10	5,556 St pc	6 St pc	43,197 m ²		Bla UGL	R9	B112 (m ²)
434662			22,780 kg	1,080 m ² 24,600 kg	984,000 kg		Bla UGL	R9	B112 (m ²)

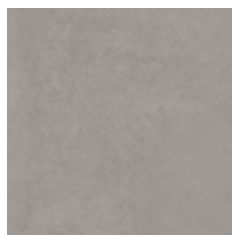

basalt
basalte
basalt

V3

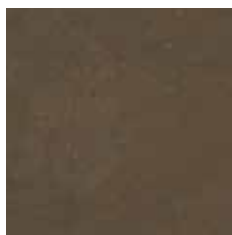

marone
brun
maroon

V3

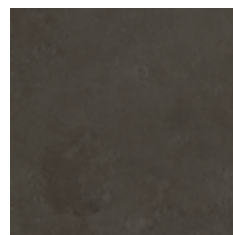

anthrazit
anthracite

V3

Bodenfliese | carreau de sol | floor tile

Feinsteinzeugfliesen unglasiert | grès cérame fin vitrifié non-émaillés | porcelain stoneware tiles unglazed

30 x 60 cm



434660

basalt, eben,
mit Glanzapplikation
basalte, lisse,
avec application brillante
basalt, smooth,
with gloss application

434661

marone, eben,
mit Glanzapplikation
brun, lisse,
avec application brillante
maroon, smooth,
with gloss application

434662

anthrazit, eben,
mit Glanzapplikation
anthracite, lisse,
avec application brillante
anthracite, smooth,
with gloss application

Art.	Nennmaß cote nominale nominal size cm	Herstellmaß cote de fabrication production size mm	m ² /m	Paket carton box	Palette palette pallet	Beanspr.-Gruppe groupe d'emploi wear resist. group	Norm Norme Standard	Trittsicherheit antidérapance non-slip	Preisgruppe groupe de prix price category
434672							Bla UGL	B440 (St pc)	
434673	7 x 60	70 x 596 x 10	1,667 St pc / m	22 St pc			Bla UGL	B440 (St pc)	
434674			1,550 kg	13,197 m	20,460 kg		Bla UGL	B440 (St pc)	
434669							Bla UGL	R10/B B284 (m ²)	
434670	5 x 5	47 x 47 x 10	11,111 Bögen plaques sheets	11 Bögen plaques sheets	29,700 m ²		Bla UGL	R10/B B284 (m ²)	
434671			21,800 kg / m ²	0,990 m ²	21,582 kg	647,460 kg	Bla UGL	R10/B B284 (m ²)	

Sockel, gerundet | plinthe, arrondie | skirting, rounded

Feinsteinzeugfliesen unglasiert | grès cérame fin vitrifié non-émaillés | porcelain stoneware tiles unglazed

7 x 60 cm



434672

basalt, eben,
mit Glanzapplikation
basalte, lisse,
avec application brillante
basalt, smooth,
with gloss application

434673

marone, eben,
mit Glanzapplikation
brun, lisse,
avec application brillante
maroon, smooth,
with gloss application

434674

anthrazit, eben,
mit Glanzapplikation
anthracite, lisse,
avec application brillante
anthracite, smooth,
with gloss application

Mosaik | mosaïque | mosaic

Feinsteinzeugfliesen unglasiert | grès cérame fin vitrifié non-émaillés | porcelain stoneware tiles unglazed

5 x 5 cm

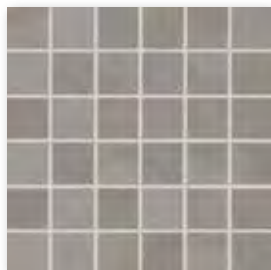

434669

basalt, eben,
mit Glanzapplikation
basalte, lisse,
avec application brillante
basalt, smooth,
with gloss application

434670

marone, eben,
mit Glanzapplikation
brun, lisse,
avec application brillante
maroon, smooth,
with gloss application

434671

anthrazit, eben,
mit Glanzapplikation
anthracite, lisse,
avec application brillante
anthracite, smooth,
with gloss application

Mosaik, Verklebung rückseitig auf Glasfasernetz,
Bogen: 297 x 297 mm

Mosaïque, collée sur trame en fibre de verre à
l'envers, Feuille : 297 x 297 mm

Mosaic, glass fibre net on reverse side,
Sheet: 297 x 297 mm

Natürlich und lässig

Regen verändert Holz im Laufe der Zeit. In der Oberfläche entstehen neue Strukturen, Effekte und von der Witterung geprägte Farben. Die Farbkarte von Mandalay umfasst helle Creme-Brauntöne, mit Grau durchmischte Braunnuancen und dunkles Braun mit Anthrazit. Die Bodenfliese überzeugt durch ihre natürliche und lässige Anmutung. Der gewollten Used Look berücksichtigt natürliche Gebrauchsspuren und zarte Verfärbungen. Die Wandfliese ist eine Kollage aus streifigen Maserungen und freien Pinselstrichen. Durch Überlagerungen und Überkreuzungen entsteht eine richtungsfreie Optik die besonders in der Farbstellung weiß-bunt ihren künstlerischen Charakter entfaltet.

Naturel et décontracté

La pluie modifie le bois au fil du temps. De nouvelles structures, de nouveaux effets et de nouvelles couleurs influencées par le temps sont créés sur la surface. Le nuancier de Mandalay comprend des bruns clairs et crémeux, des bruns mélangés à du gris et des bruns foncés avec de l'anthracite. Le carreau de sol convainc grâce à son flair naturel et décontracté. L'aspect usagé délibéré « Used Look » tient compte des traces naturelles d'utilisation et de la délicate décoloration. Le carreau de mur est un collage de veinures rayées et de coups de pinceau à main libre. Les superpositions et les croisements créent un look non directionnel qui déploie son caractère artistique, notamment dans le schéma de couleurs blanc-multicolore.

Natural and casual

Rain changes wood over time. New structures, effects and weathered colours are created on the surface. Mandalay's colour card includes light cream-brown shades, brown shades mixed with grey and dark brown with anthracite. The floor tile convinces with its natural and casual look. The intended used look takes into account natural signs of wear and delicate discolouration. The wall tile is a collage of striped grains and free brush strokes. Overlays and crossings create a non-directional look that unfolds its artistic character especially in the colour scheme white and colourful.





Art.	Nennmaß cote nominale nominal size cm	Herstellmaß cote de fabrication production size mm	m ² /m	Paket carton box	Palette palette pallet	Beanspr.-Gruppe groupe d'emploi wear resist. group	Norm Norme Standard	Trittsicherheit antidérapance non-slip	Preisgruppe groupe de prix price category
282901	30 x 60	297 x 597 x 9	5,556 St pc / m ²	9 St pc	77,754 m ²		BIII GL	B65 (m²)	
282902			14,946 kg	1,620 m ² 24,210 kg	1.162,080 kg		BIII GL	B65 (m²)	
282903	4 x 60	37 x 597 x 10,5	1,667 St pc / m	3 St pc			Bla UGL	B447 (St pc)	
			0,910 kg	1,800 m 1,638 kg					

Wandfliese | carreau de mur | wall tile

Steingut glasiert | faïence émaillée | earthenware glazed

30 x 60 cm



V2



V4

282901

naturweiß | blanc nature | natural-white
seidenmatt, eben | satiné, lisse | silky-matt, smooth

282902

weiß-bunt | blanc multicolore | white-colorful
seidenmatt, eben | satiné, lisse | silky-matt, smooth

Dekorationselemente | éléments décoratifs | decoration elements

Bordüre Canvas | bordure Canvas | border Canvas

Feinsteinzeugfliesen unglasiert | grès cérame fin vitrifié non-émaillés | porcelain stoneware tiles unglazed

4 x 60 cm

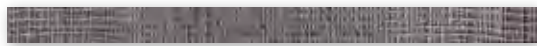

Nur für die Verlegung an der Wand im Innenbereich geeignet.
Convient uniquement pour une pose murale en intérieur.
Only suitable for laying on the wall in indoor areas.

282903

grau-schwarz | noir gris | grey-black
strukturiert, matt | structuré, mat | structured, matt

Abgabe der Dekorationselemente ausschließlich in vollen Kartons.
Éléments décoratifs uniquement livrables en cartons entiers.
Decoration elements only available in full boxes.

Art.	Nennmaß cote nominale nominal size cm	Herstellmaß cote de fabrication production size mm	m ²	Paket carton box	Palette palette pallet	Beanspr.-Gruppe groupe d'emploi wear resist. group	Norm Norme Standard	Trittsicherheit antidérapance non-slip	Preisgruppe groupe de prix price category
434490							Bla UGL	R10/A	B138 (m ²)
434491	15 x 60	147 x 597 x 10,5	11,111 St pc	11 St pc	39,600 m ²		Bla UGL	R10/A	B138 (m ²)
434492			23,222 kg	0,990 m ²	22,990 kg		Bla UGL	R10/A	B138 (m ²)
434493							Bla UGL	R10/A	B138 (m ²)
434478							Bla UGL	R10/A	B112 (m ²)
434479	30 x 60	297 x 597 x 10,5	5,556 St pc	6 St pc	43,197 m ²		Bla UGL	R10/A	B112 (m ²)
434480			23,224 kg	1,080 m ²	25,080 kg		Bla UGL	R10/A	B112 (m ²)
434481							Bla UGL	R10/A	B112 (m ²)



weißgrau
gris blanc
white-grey

V3

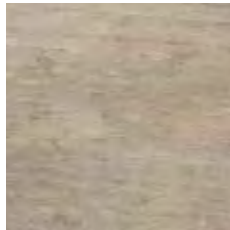

hellbraun
brun clair
light-brown

V3

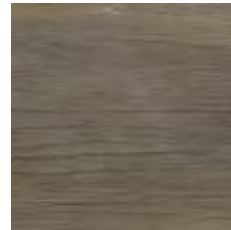

rauchbraun
brun fumé
smoky-brown

V3

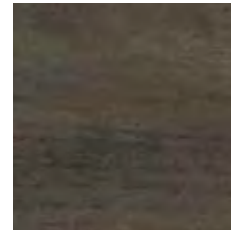

schwarzbraun
brun noir
black-brown

V3

Bodenfliese | carreau de sol | floor tile

Feinsteinzeugfliesen unglasiert | grès cérame fin vitrifié non-émaillés | porcelain stoneware tiles unglazed

15 x 60 cm Riegelformat | format de traverse | oblong format



434490
weißgrau | gris blanc | white-grey
strukturiert, matt
structuré, mat
structured, matt

434491
hellbraun | brun clair | light-brown
strukturiert, matt
structuré, mat
structured, matt

434492
rauchbraun | brun fumé |
smoky-brown
strukturiert, matt
structuré, mat
structured, matt

434493
schwarzbraun | brun noir | black-brown
strukturiert, matt
structuré, mat
structured, matt

Auftragsfertigung: Rückgabe und/oder Stornierung bestellter Ware nicht möglich.

Fabrication sur commande : il nous est impossible d'accepter l'annulation de commandes d'articles ou le retour d'articles.

Make-to-order production: return and/or cancellation of ordered products not possible.

30 x 60 cm



434478
weißgrau | gris blanc | white-grey
strukturiert, matt
structuré, mat
structured, matt

434479
hellbraun | brun clair | light-brown
strukturiert, matt
structuré, mat
structured, matt

434480
rauchbraun | brun fumé | smoky-brown
strukturiert, matt
structuré, mat
structured, mattd

434481
schwarzbraun | brun noir | black-brown
strukturiert, matt
structuré, mat
structured, matt

Art.	Nennmaß cote nominale nominal size cm	Herstellmaß cote de fabrication production size mm	m ² /m	Paket carton box	Palette palette pallet	Beanspr.-Gruppe groupe d'emploi wear resist. group	Norm Norme Standard	Trittsicherheit antidérapance non-slip	Preisgruppe groupe de prix price category
434506							Bla UGL		B440 (St pc)
434507	7 x 60	70 x 597 x 10,5	1,667 St pc / m	15 St pc			Bla UGL		B440 (St pc)
434508			1,584 kg	8,998 m	14,250 kg		Bla UGL		B440 (St pc)
434509							Bla UGL		B440 (St pc)
434498							Bla UGL	R10/B	B284 (m ²)
434499	5 x 5	47 x 47 x 10,5	11,111 Bögen plaques sheets	11 Bögen plaques sheets	29,700 m ²		Bla UGL	R10/B	B284 (m ²)
434500			22,222 kg / m ²	0,990 m ²	22,000 kg	660,000 kg	Bla UGL	R10/B	B284 (m ²)
434501							Bla UGL	R10/B	B284 (m ²)

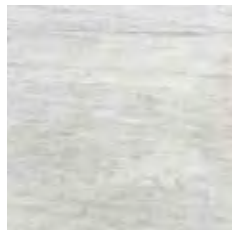

weißgrau
gris blanc
white-grey

V3

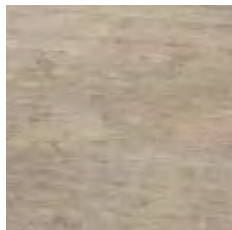

hellbraun
brun clair
light-brown

V3

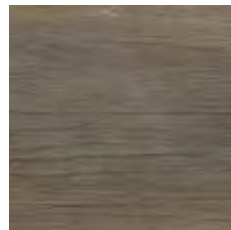

rauchbraun
brun fumé
smoky-brown

V3

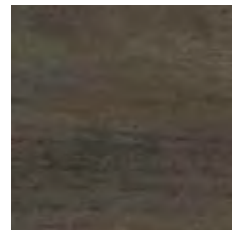

schwarzbraun
brun noir
black-brown

V3

Sockel, gerundet | plinthe, arrondie | skirting, rounded

Feinsteinzeugfliesen unglasiert | grès cérame fin vitrifié non-émaillés | porcelain stoneware tiles unglazed

7 x 60 cm



434506

weißgrau | gris blanc | white-grey
strukturiert, matt
structuré, mat
structured, matt

434507

hellbraun | brun clair | light-brown
strukturiert, matt
structuré, mat
structured, matt

434508

rauchbraun | brun fumé | smoky-brown
strukturiert, matt
structuré, mat
structured, mattd

434509

schwarzbraun | brun noir | black-brown
strukturiert, matt
structuré, mat
structured, matt

Mosaik | mosaïque | mosaic

Feinsteinzeugfliesen unglasiert | grès cérame fin vitrifié non-émaillés | porcelain stoneware tiles unglazed

5 x 5 cm



434498

weißgrau | gris blanc | white-grey
strukturiert, matt
structuré, mat
structured, matt

434499

hellbraun | brun clair | light-brown
strukturiert, matt
structuré, mat
structured, matt

Mosaik, Verklebung rückseitig auf Glasfasernetz
Bogen: 297 x 297 mm

Mosaïque, collée sur trame en fibre de verre à
l'envers, Feuille: 297 x 297 mm

434500

rauchbraun | brun fumé | smoky-brown
strukturiert, matt
structuré, mat
structured, mattd

434501

schwarzbraun | brun noir | black-brown
strukturiert, matt
structuré, mat
structured, matt

Mosaic, glass fibre net on reverse side
Sheet: 297 x 297 mm





Studioaufnahme · photo prise en studio · studio photo / Architekt · architecte · architect: STELLWERK architekten, Dresden, Deutschland
Allemagne · Germany / Serie · série · series: Mando / Photo: Jochen Stüber



Herr der Gezeiten – Zeit für Inspiration

Mando verleiht einem Bad ein helles und luftiges, an Sand, Treibgut und Wind erinnerndes Ambiente. Matt- oder glänzend-weiße Wandfliesen in 35 x 100 cm schaffen einen klaren Rahmen für das Volldekor Spirit im gleichen Format – in grau-blau matt oder creme-cotto matt. Ein weiteres optisches Highlight in korrespondierenden Farben: das Riegel-Dekor Cabana mit Holz-Mix-Optik in 8,45 x 33 cm. In diese Gesamtidée von authentischer Natürlichkeit fügt sich die Vintage-Holz-Serie Walden als Boden harmonisch ein. Alle Fliesen von Mando sind aufgrund ihrer Hytect-Oberfläche reinigungsfreundlich.

Le Prince des marées, l'heure de l'inspiration

Mando donne à la salle de bain une ambiance claire et aérée qui rappelle le sable, les débris flottants et le vent. Les carreaux muraux blancs, mats ou brillants, de 35 x 100 cm, créent les conditions parfaites pour un esprit de décor absolu, en mat gris-bleu ou crème-cotto. Un autre atout visuel aux coloris assortis sont les carreaux transversaux Cabana d'aspect bois en 8,45 x 33 cm. La série en bois vintage Walden pour le sol complète harmonieusement l'idée globale de nature authentique. Tous les carreaux de Mando sont faciles à nettoyer grâce à leur surface Hytect.

The prince of tides – time for inspiration

Mando lends bathrooms a bright and airy ambience reminiscent of sand, Walden and wind. Matt or glossy white wall tiles in 35 x 100 cm create a clear framework for the Spirit full decor of the same size – in grey-blue matt or cream-cotto matt. Another visual highlight in matching colors: the Cabana strip decor with a wood mix look in 8.45 x 33 cm. The Walden vintage wood series harmoniously integrates as a floor in this overall idea of authentic naturalness. All Mando tiles are easy to clean thanks to their Hytect surface.

Art.	Nennmaß cote nominale nominal size cm	Herstellmaß cote de fabrication production size mm	m ² /m	Paket carton box	Palette palette pallet	Beanspr.-Gruppe groupe d'emploi wear resist. group	Norm Norme Standard	Trittsicherheit antidérapance non-slip	Preisgruppe groupe de prix price category
363347H	35 x 100	347 x 997 x 6	2,857 St pc / m ²	5 St pc	70,000 m ²		BIII GL		W151 (m ²)
363348H			10,513 kg	1,750 m ² 18,400 kg	736,000 kg		BIII GL		W151 (m ²)
363351H	8,45 x 33	84,5 x 330 x 6	3,030 St pc / m	18 St pc			BIII GL		W421 (St pc)
			0,878 kg	5,940 m 5,220 kg					

Wandfliese | carreau de mur | wall tile

Steingut glasiert | faïence émaillée | earthenware glazed

35 x 100 cm

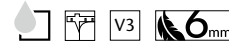

363347H

weiß glänzend | blanc brillant | white glossy
eben | lisse | smooth

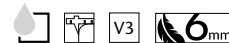

363348H

weiß matt | blanc mat | white matt
eben | lisse | smooth

Dekorationselemente | éléments décoratifs | decoration elements

Dekorfliese Cabana | carreau décoratif Cabana | decorative element Cabana

Steingut glasiert | faïence émaillée | earthenware glazed

Verlegebeispiele | Exemples de pose | laying examples

8,45 x 33 cm



363351H

braun-mix | mélange marron | brown-mix
seidenmatt, eben | satiné, lisse | silky-matt, smooth

Die Riegel Cabana variieren bewusst in der Farbigkeit. Bitte gemischt aus mehreren Kartons verlegen, damit sich ein gleichmäßiges Bild ergibt.
Les couleurs des carreaux transversaux Cabana varient volontairement. Veuillez mélanger plusieurs cartons lors de la pose pour obtenir un résultat uniforme.
The Cabana strips consciously vary in terms of color. Please combine tiles from several boxes to provide a consistent appearance.

Abgabe der Dekorationselemente ausschließlich in vollen Kartons.
Éléments décoratifs uniquement livrables en cartons entiers.
Decoration elements only available in full boxes.

Art.	Nennmaß cote nominale nominal size cm	Herstellmaß cote de fabrication production size mm	m	Paket carton box	Palette palette pallet	Beanspr.-Gruppe groupe d'emploi wear resist. group	Norm Norme Standard	Trittsicherheit antidérapance non-slip	Preisgruppe groupe de prix price category
363349H	35 x 100	347 x 997 x 6	1,000 St pc 3,680 kg	3 St pc 3,000 m 11,040 kg			BIII GL		3 x W499 (St pc)

Dekorationselemente | éléments décoratifs | decoration elements

Dekorfliese Spirit | carreau décoratif Spirit | decorative element Spirit

Steingut glasiert | faïence émaillée | earthenware glazed

35 x 100 cm

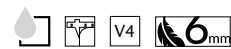

363349H

grau-blau | gris bleu | grey-blue
 seidenmatt, eben | satiné, lisse | silky-matt, smooth
 3er-Set | jeu de 3 carreaux | set of 3 tiles



Abgabe der Dekorationselemente ausschließlich in vollen Kartons.
 Eléments décoratifs uniquement livrables en cartons entiers.
 Decoration elements only available in full boxes.

Bodenempfehlung Serie Walden, siehe Seite 226.
 Recommandation relative au sol, série Walden, voir page 226.
 Recommended floor tiles: series Walden, see page 226.

Art.	Nennmaß cote nominale nominal size cm	Herstellmaß cote de fabrication production size mm	m	Paket carton box	Palette palette pallet	Beanspr.-Gruppe groupe d'emploi wear resist. group	Norm Norme Standard	Trittsicherheit antidérapance non-slip	Preisgruppe groupe de prix price category
363350H	35 x 100	347 x 997 x 6	1,000 St pc 3,680 kg	3 St pc 3,000 m 11,040 kg			BIII GL		3 x W499 (St pc)

Dekorationselemente | éléments décoratifs | decoration elements

Dekorfliese Spirit | carreau décoratif Spirit | decorative element Spirit

Steingut glasiert | faïence émaillée | earthenware glazed

35 x 100 cm

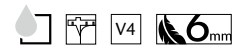

363350H

creme-cotto | crème-cotto | cream-cotto
 seidenmatt, eben | satiné, lisse | silky-matt, smooth
 3er-Set | jeu de 3 carreaux | set of 3 tiles

Abgabe der Dekorationselemente ausschließlich in vollen Kartons.
 Éléments décoratifs uniquement livrables en cartons entiers.
 Decoration elements only available in full boxes.

Bodenempfehlung Serie Walden, siehe Seite 226.
 Recommandation relative au sol, série Walden, voir page 226.
 Recommended floor tiles: series Walden, see page 226.



Studioaufnahme · photo prise en studio · studio photo / Architekt · architecte · architect: STELLWERK architekten, Dresden, Deutschland · Allemagne · Germany / Serie · série · series: Mando / Photo: Jochen Stüber



Wunderbar wandelbares Weiß

Puristische Klarheit? Entspannendes Naturambiente? Bei Modern White machen die Dekorelemente den Unterschied. Je nach Wahl harmonisiert die perlweiß glänzende Wandfliese mit einer großen Bandbreite von Einrichtungsstilen. Lieferbar ist eine Bordüre, die schwarzem Sahara-Marmor nachempfunden ist, dazu eine weniger kontrastreiche Variante in ruhigen Grautönen. Die Dekorrichtung „Botanic“ bringt ein Stück exotische Natur in das eigene Zuhause. Ein Glanzdruck in Blätteroptik, der auf die seidigmatte Fliesenoberfläche gedruckt wird, schafft eine elegante Verbindung zur glänzenden Basisfliese der Serie.

Un blanc merveilleusement changeant

Clarté épurée ? Ambiance naturelle relaxante ? Avec Modern White, ce sont les éléments décoratifs qui font la différence. Selon votre choix, le carrelage mural blanc nacré s'associera harmonieusement avec un large éventail de styles de décoration intérieure. La gamme comporte une bordure, inspirée du marbre noir du Sahara, ainsi qu'une variante moins contrastée déclinée dans des teintes apaisées de gris. Le style décoratif « Botanic » apporte aux espaces intérieurs une touche de nature exotique. Un motif de feuille imprimé en surbrillance sur la surface mate et soyeuse des carreaux crée un lien élégant avec le carreau de base brillant de la collection.

Wonderfully transformative white

Purist clarity? Relaxing natural ambience? Decorative elements make the difference in the Modern White range. Depending on the selection, the shimmering pearl white wall tile harmonises with a wide range of interior styles. A border is available which is based on black Sahara marble and another less contrasting variant in calm shades of grey. The "Botanic" decorative style adds an exotic touch to any home. A glossy print in leaf optic which is printed on the silky-matt tile surface creates an elegant linking element to the glossy basic tiles in the range.





MODERN WHITE

Art.	Nennmaß cote nominale nominal size cm	Herstellmaß cote de fabrication production size mm	m ²	Paket carton box	Palette palette pallet	Beanspr.-Gruppe groupe d'emploi wear resist. group	Norm Norme Standard	Trittsicherheit antidérapance non-slip	Preisgruppe groupe de prix price category
283047H	30 x 60	297 x 597 x 9	5,556 St pc 14,946 kg	9 St pc 1,620 m ² 24,210 kg	77,754 m ² 1.162,080 kg		BIII GL		W91 (m ²)
393050H	30 x 90	297 x 897 x 10,5	3,704 St pc 17,976 kg	5 St pc 1,350 m ² 24,265 kg	32,397 m ² 582,360 kg		BIII GL		W114 (m ²)

Wandfliese | carreau de mur | wall tile

Steingut glasiert | faïence émaillée | earthenware glazed

30 x 60 cm

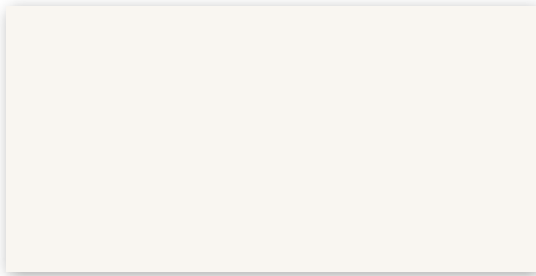

283047H

perlweiß, glänzend | blanc perle, brillant | pearl-white, glossy
glänzend, eben | brillant, lisse | glossy, smooth

30 x 90 cm

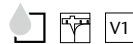
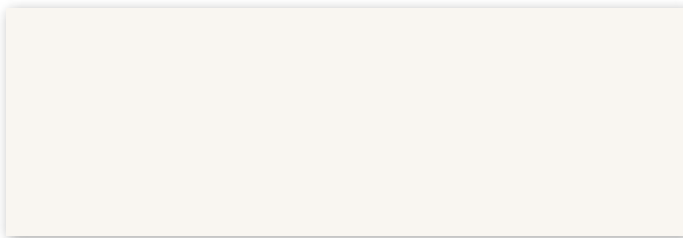

393050H

perlweiß, glänzend | blanc perle, brillant | pearl-white, glossy
glänzend, eben | brillant, lisse | glossy, smooth

Art.	Nennmaß cote nominale nominal size cm	Herstellmaß cote de fabrication production size mm	m	Paket carton box	Palette palette pallet	Beanspr.-Gruppe groupe d'emploi wear resist. group	Norm Norme Standard	Trittsicherheit antidérapance non-slip	Preisgruppe groupe de prix price category
283048H	10 x 60	97 x 597 x 9	1,667 St pc	6 St pc			BIII GL		W421 (St pc)
283049H			1,409 kg	3,600 m	5,070 kg		BIII GL		W421 (St pc)
393051H	10 x 90	97 x 897 x 10,5	1,111 St pc	6 St pc			BIII GL		W432 (St pc)
393052H			1,744 kg	5,400 m	9,420 kg		BIII GL		W432 (St pc)

Dekorationselemente | éléments décoratifs | decoration elements

Bordüre | bordure | border

Steingut glasiert | faïence émaillée | earthenware glazed

10 x 60 cm

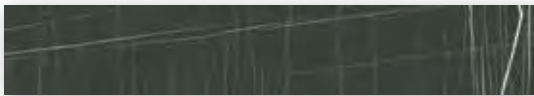

283048H

schwarz | noir | black
seidenmatt, eben | satinée, lisse | silky-matt, smooth



283049H

basaltgrau | gris basalte | basalt-grey
seidenmatt, eben | satinée, lisse | silky-matt, smooth

10 x 90 cm

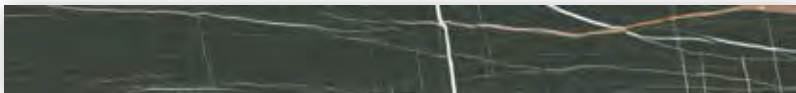

393051H

schwarz | noir | black
seidenmatt, eben | satinée, lisse | silky-matt, smooth

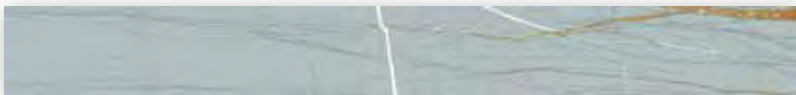

393052H

basaltgrau | gris basalte | basalt-grey
seidenmatt, eben | satinée, lisse | silky-matt, smooth

Abgabe der Dekorationselemente ausschließlich in vollen Kartons.
Éléments décoratifs uniquement livrables en cartons entiers.
Decoration elements only available in full boxes.

MODERN WHITE

Art.	Nennmaß cote nominale nominal size cm	Herstellmaß cote de fabrication production size mm	m	Paket carton box	Palette palette pallet	Beanspr.-Gruppe groupe d'emploi wear resist. group	Norm Norme Standard	Trittsicherheit antidérapance non-slip	Preisgruppe groupe de prix price category
283113H	30 x 60	297 x 597 x 9	1,667 St pc	2 St pc			BIII GL		2 x W424 (St pc)
283114H			4,484 kg	1,200 m 5,380 kg			BIII GL		2 x W424 (St pc)

Dekorationselemente | éléments décoratifs | decoration elements

Dekorfliese Botanic | carreau décoratif Botanic | decorative element Botanic

Steingut glasiert | faïence émaillée | earthenware glazed

30 x 60 cm



283113H

tropical garden

seidenmatt, eben | satinée, lisse | silky-matt, smooth
2er-Set | jeu de 2 carreaux | set of 2 tiles



283114H

urban garden

seidenmatt, eben | satinée, lisse | silky-matt, smooth
2er-Set | jeu de 2 carreaux | set of 2 tiles



Abgabe der Dekorationselemente ausschließlich in vollen Kartons.
Éléments décoratifs uniquement livrables en cartons entiers.
Decoration elements only available in full boxes.

Bodenempfehlung Serien Soul (Seite 196), Oak (Seite 156).
Recommandation de carreaux de sol, séries Soul (page 196), Oak (page 156).
Recommended floor tiles: series Soul (page 196), Oak (page 156).

Art.	Nennmaß cote nominale nominal size cm	Herstellmaß cote de fabrication production size mm	m	Paket carton box	Palette palette pallet	Beanspr.-Gruppe groupe d'emploi wear resist. group	Norm Norme Standard	Trittsicherheit antidérapance non-slip	Preisgruppe groupe de prix price category
393115H	30 x 90	297 x 897 x 10,5	1,111 St pc	2 St pc			BIII GL		2 x W462 (St pc)
393116H			5,392 kg	1,800 m 9,706 kg			BIII GL		2 x W462 (St pc)

Dekorationselemente | éléments décoratifs | decoration elements

Dekorfliese Botanic | carreau décoratif Botanic | decorative element Botanic

Steingut glasiert | faïence émaillée | earthenware glazed

30 x 90 cm



393115H

tropical garden
 seidenmatt, eben | satinée, lisse | silky-matt, smooth
 2er-Set | jeu de 2 carreaux | set of 2 tiles



393116H

urban garden
 seidenmatt, eben | satinée, lisse | silky-matt, smooth
 2er-Set | jeu de 2 carreaux | set of 2 tiles



Abgabe der Dekorationselemente ausschließlich in vollen Kartons.
 Éléments décoratifs uniquement livrables en cartons entiers.
 Decoration elements only available in full boxes.

Bodenempfehlung Serien Soul (Seite 196), Oak (Seite 156).
 Recommandation de carreaux de sol, séries Soul (page 196), Oak (page 156).
 Recommended floor tiles: series Soul (page 196), Oak (page 156).

Pflegeleichter Holz-Look

Mit Oak gelingt eine elegante und raffinierte Holzoptik – in Eiche creme, Eiche natur oder Eiche anthrazit. Die Bodenserie verfügt über 5 Formatvarianten, Treppenelemente, Sockel sowie ein 6-eckiges Bodendekor mit 30 x 35 cm – alle mit Hytect-Oberfläche – für viel Gestaltungsspielraum im einheitlichen Look. Für modernen Touch sorgen drei Paneelen-Formate mit 30 x 120, 40 x 120 und 60 x 120 cm. Durch die großen Formate kommt die Maserung besonders gut zur Geltung. Als passende Bordüre empfiehlt sich die aus Oak geschnittene Dekoration „Verso“ der Serie Sky (siehe Seite 182).

Aspect bois sans entretien

Décliné dans les teintes chêne crème, chêne nature et chêne anthracite, Oak et son effet bois apportent élégance et raffinement. Avec des carreaux de sol en 5 formats différents, des carreaux d'escalier, des plinthes et un élément de décoration hexagonal de 30 x 35 cm – tous avec surface Hytect – la gamme offre une grande liberté conceptuelle pour un aménagement harmonisé. Trois formats de lambris de 30 x 120, 40 x 120 et 60 x 120 cm apportent une touche de modernité. Ces grands formats mettent particulièrement en valeur les veinures du motif bois. La bordure assortie « Verso » est un élément de décoration issu de la gamme Sky (voir page 182).

Easy-care wood look

Oak achieves an elegant and refined wood look – in cream, natural or anthracite variants. The floor series offers 5 different sizes, stair elements, skirtings and a hexagonal floor décor in 30 x 35 cm – all of them with Hytect surface – for plenty of design freedom with a uniform appearance. A modern touch is provided by three panel sizes measuring 30 x 120, 40 x 120 and 60 x 120 cm. These large formats show the grain at its best advantage. The “Verso” décor cut from Oak in the Sky series is recommended as a matching border (see page 182).





Art.	Nennmaß cote nominale nominal size cm	Herstellmaß cote de fabrication production size mm	m ²	Paket carton box	Palette palette pallet	Beanspr.-Gruppe groupe d'emploi wear resist. group	Norm Norme Standard	Trittsicherheit antidérapance non-slip	Preisgruppe groupe de prix price category
8471-B695HK	15 x 90	147 x 897 x 8	7,407 St pc	8 St pc	43,202 m ²		Alb UGL	R10/A	W154 (m ²)
8472-B695HK			17,495 kg	1,081 m ² 18,896 kg	755,840 kg		Alb UGL	R10/A	W154 (m ²)
8471-B690HK	30 x 90	297 x 897 x 8	3,704 St pc	5 St pc	40,497 m ²		Alb UGL	R10/A	W143 (m ²)
8472-B690HK			17,501 kg	1,350 m ² 23,625 kg	708,750 kg		Alb UGL	R10/A	W143 (m ²)

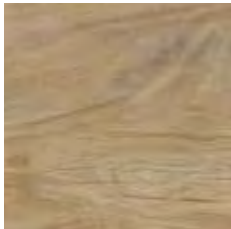

Eiche natur
chêne nature
natural oak

V4

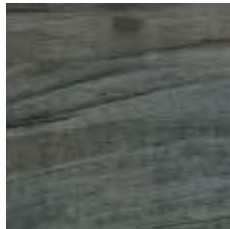

Eiche anthrazit
chêne anthracite
anthracite oak

V3

Bodenfliese | carreau de sol | floor tile

Feinsteinzeugplatten unglasiert | grès fin non-émaillés | porcelain stoneware tiles unglazed

15 x 90 cm Riegelformat | format de traverse | oblong format

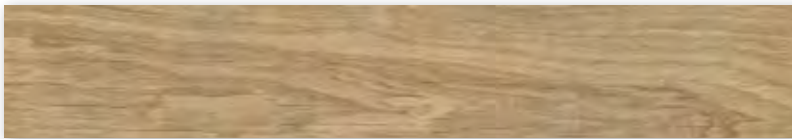

Auftragsfertigung Riegelformat:
Rückgabe und/oder Stornierung
bestellter Ware nicht möglich.

Fabrication sur commande des
formats en traverse : il nous est
impossible d'accepter l'annulation
de commandes d'articles ou
le retour d'articles.

Make-to-order production in
the case of oblong formats:
return and/or cancellation of
ordered products not possible.

8471-B695HK

Eiche natur | chêne nature | natural oak
strukturiert, matt | structuré, mat | structured, matt

8472-B695HK

Eiche anthrazit | chêne anthracite | anthracite oak
strukturiert, matt | structuré, mat | structured, matt

30 x 90 cm



8471-B690HK

Eiche natur | chêne nature | natural oak
strukturiert, matt | structuré, mat | structured, matt

8472-B690HK

Eiche anthrazit | chêne anthracite | anthracite oak
strukturiert, matt | structuré, mat | structured, matt

Art.	Nennmaß cote nominale nominal size cm	Herstellmaß cote de fabrication production size mm	m ²	Paket carton box	Palette palette pallet	Beanspr.-Gruppe groupe d'emploi wear resist. group	Norm Norme Standard	Trittsicherheit antidérapance non-slip	Preisgruppe groupe de prix price category
8471-B620HK	30 x 120	297 x 1197 x 8	2,778 St pc	4 St pc	43,197 m ²		Alb UGL	R10/A	W154 (m ²)
8472-B620HK			17,501 kg	1,440 m ² 25,200 kg	756,000 kg		Alb UGL	R10/A	W154 (m ²)
8471-B660HK	40 x 120	397 x 1197 x 8	2,083 St pc	3 St pc	51,848 m ²		Alb UGL	R10/A	W154 (m ²)
8472-B660HK			17,497 kg	1,440 m ² 25,200 kg	907,200 kg		Alb UGL	R10/A	W154 (m ²)

Bodenfliese | carreau de sol | floor tile

Feinsteinzeugplatten unglasiert | grès fin non-émaillés | porcelain stoneware tiles unglazed

30 x 120 cm



8471-B620HK

Eiche natur | chêne nature | natural oak
strukturiert, matt | structuré, mat | structured, matt

8472-B620HK

Eiche anthrazit | chêne anthracite | anthracite oak
strukturiert, matt | structuré, mat | structured, matt

40 x 120 cm



8471-B660HK

Eiche natur | chêne nature | natural oak
strukturiert, matt | structuré, mat | structured, matt

8472-B660HK

Eiche anthrazit | chêne anthracite | anthracite oak
strukturiert, matt | structuré, mat | structured, matt

OAK

Art.	Nennmaß cote nominale nominal size cm	Herstellmaß cote de fabrication production size mm	m ² /m	Paket carton box	Palette palette pallet	Beanspr.-Gruppe groupe d'emploi wear resist. group	Norm Norme Standard	Trittsicherheit antidérapance non-slip	Preisgruppe groupe de prix price category
8471-B670HK	60 x 120	597 x 1197 x 8	1,388 St pc / m ²	2 St pc	36,023 m ²		Alb UGL	R10/A	W154 (m ²)
8472-B670HK			17,489 kg	1,441 m ² 25,200 kg	630,000 kg		Alb UGL	R10/A	W154 (m ²)
8471-B629HK	30 x 120	297 x 1197 x 8	0,833 St pc / m	4 St pc			Alb UGL	R10/A	W559 (St pc)
8472-B629HK			5,248 kg	4,802 m 25,200 kg			Alb UGL	R10/A	W559 (St pc)



Eiche natur
chêne nature
natural oak

V4



Eiche anthrazit
chêne anthracite
anthracite oak

V3

Bodenfliese | carreau de sol | floor tile

Feinsteinzeugplatten unglasiert | grès fin non-émaillés | porcelain stoneware tiles unglazed

60 x 120 cm



8471-B670HK

Eiche natur | chêne nature | natural oak
strukturiert, matt | structuré, mat | structured, matt

8472-B670HK

Eiche anthrazit | chêne anthracite | anthracite oak
strukturiert, matt | structuré, mat | structured, matt

Treppenfliese | nez de marche | stair tile

Feinsteinzeugplatten unglasiert | grès fin non-émaillés | porcelain stoneware tiles unglazed

30 x 120 cm



8471-B629HK

Eiche natur | chêne nature | natural oak
strukturiert, matt | structuré, mat | structured, matt

8472-B629HK

Eiche anthrazit | chêne anthracite | anthracite oak
strukturiert, matt | structuré, mat | structured, matt

Auftragsfertigung: Rückgabe und/oder Stornierung bestellter Ware nicht möglich.
Fabrication sur commande : il nous est impossible d'accepter l'annulation de commandes d'articles ou le retour d'articles.
Make-to-order production: return and/or cancellation of ordered products not possible.

Art.	Nennmaß cote nominale nominal size cm	Herstellmaß cote de fabrication production size mm	m	Paket carton box	Palette palette pallet	Beanspr.-Gruppe groupe d'emploi wear resist. group	Norm Norme Standard	Trittsicherheit antidérapance non-slip	Preisgruppe groupe de prix price category
8471-B610HK	6 x 60	60 x 597 x 8	1,667 St pc	27 St pc			Alb UGL		W439 (St pc)
8472-B610HK			1,100 kg	16,197 m	17,820 kg		Alb UGL		W439 (St pc)
8471-B698HK	30 x 35	298 x 344,1 x 8	3,333 St pc	3 St pc			Alb UGL	R10/A	W518 (St pc)
8472-B698HK			4,166 kg	0,900 m	3,750 kg		Alb UGL	R10/A	W518 (St pc)

Sockel, gerundet | plinthe, arrondie | skirting, rounded

Feinsteinzeugplatten unglasiert | grès fin non-émaillés | porcelain stoneware tiles unglazed

6 x 60 cm



8471-B610HK

Eiche natur | chêne nature | natural oak
strukturiert, matt | structuré, mat | structured, matt

8472-B610HK

Eiche anthrazit | chêne anthracite | anthracite oak
strukturiert, matt | structuré, mat | structured, matt

Dekorationselemente | éléments décoratifs | decoration elements

Dekorfliese Hexagon | carreau décoratif Hexagon | decorative element Hexagon

Feinsteinzeugplatten unglasiert | grès fin non-émaillés | porcelain stoneware tiles unglazed

30 x 35 cm



8471-B698HK

Eiche natur | chêne nature | natural oak
strukturiert, matt | structuré, mat | structured, matt

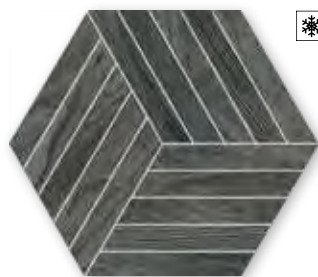

8472-B698HK

Eiche anthrazit | chêne anthracite | anthracite oak
strukturiert, matt | structuré, mat | structured, matt

Mosaik, Verklebung rückseitig auf Glasfasernetz,
Bogen: 298 x 344,1 mm

Mosaïque, collée sur trame en fibre de verre à
l'envers, Feuille: 298 x 344,1 mm

Mosaic, glass fibre net on reverse side,
Sheet: 298 x 344.1 mm

Abgabe der Dekorationselemente ausschließlich in vollen Kartons.
Éléments décoratifs uniquement livrables en cartons entiers.
Decoration elements only available in full boxes.



SEAT-Autohaus · SEAT-Concessionnaire automobile · SEAT-Car dealer / Serie · série · series: Pizarro / Photo: Jochen Stüber



Ein Zitat aus der Natur

Für Liebhaber von natürlicher Optik: Die markant strukturierte Oberfläche der Serie Pizarro erinnert an Schiefergestein – keramisch umgesetzt. Die Wandfliesen in schlichtem Weiß und zartem Grau sind eine perfekte Wandbekleidung für zeitlose Badezimmer in einem reduzierten Ambiente. Für eine Rhythmisierung oder Akzentuierung der Wandfläche stehen elegante Bordüren mit metallischen Einlegern in den beiden klassischen Bodenfarben zur Verfügung. Die Bodenfliesen sind Protecta-vergütet.

Une citation de la nature

Pour les amateurs d'un visuel naturel : la surface remarquablement structurée de la série Pizarro rappelle celle de l'ardoise – version céramique. Les carreaux de mur en blanc uni et gris délicat sont un revêtement mural parfait pour les salles de bains hors temps dans une ambiance minimaliste. Des bordures élégantes avec des incrustations métalliques aux deux couleurs de sol classiques sont disponibles pour rythmer ou accentuer la surface du mur. Les carreaux de sol ont reçu un traitement Protecta.

A quotation from nature

For lovers of a natural look: the strikingly structured surface of the Pizarro series is reminiscent of slate – in a ceramic interpretation. The wall tiles in plain white and delicate grey are a perfect wall cladding for timeless bathrooms in a reduced ambience. For a rhythmic or accentuated look of the wall surface, elegant borders with metallic inlays in the two classic floor colours are available. The floor tiles are Protecta-upgraded.

Art.	Nennmaß cote nominale nominal size cm	Herstellmaß cote de fabrication production size mm	m ² /m	Paket carton box	Palette palette pallet	Beanspr.-Gruppe groupe d'emploi wear resist. group	Norm Norme Standard	Trittsicherheit antidérapance non-slip	Preisgruppe groupe de prix price category
281476	30 x 60	297 x 597 x 9	5,556 St pc / m ²	9 St pc	77,754 m ²		BIII GL		B69 (m ²)
281477			14,946 kg	1,620 m ² 24,210 kg	1.162,080 kg		BIII GL		B69 (m ²)
281479	15 x 60	147 x 597 x 10,5	1,667 St pc / m	1 St pc			Bla UGL		B510 (St pc)
281480			3,584 kg	0,600 m 2,150 kg			Bla UGL		B510 (St pc)

Wandfliese | carreau de mur | wall tile

Steingut glasiert | faïence émaillée | earthenware glazed

30 x 60 cm

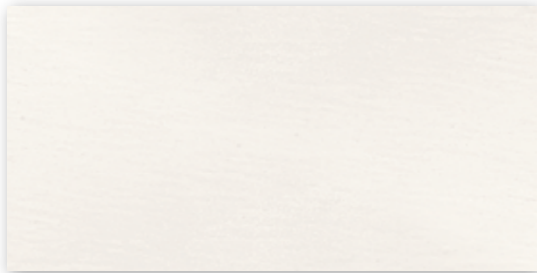

V1

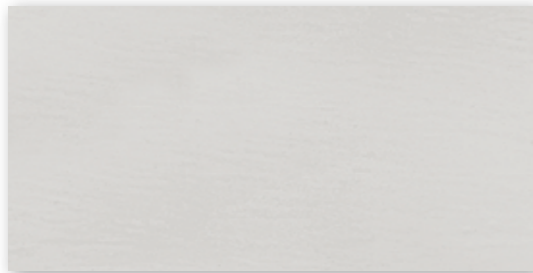

V1

281476

weiß | blanc | white
seidenmatt, strukturiert | satiné, structuré | silky-matt, structured

281477

grau | gris | grey
seidenmatt, strukturiert | satiné, structuré | silky-matt, structured

Dekorationselemente | éléments décoratifs | decoration elements

Bordüre | bordure | border

Feinsteinzeugfliesen unglasiert | grès cérame fin vitrifié non-émaillés | porcelain stoneware tiles unglazed

15 x 60 cm

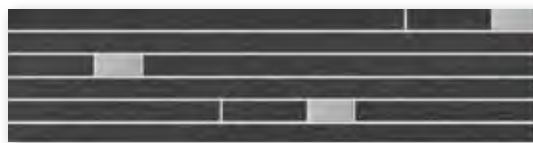

281479

anthrazit | anthracite
strukturiert, matt | structuré, mat | structured, matt

281480

schwarz | noir | black
strukturiert, matt | structuré, mat | structured, matt

Nur für die Verlegung an der Wand geeignet.
Uniquement approprié pour l'utilisation aux murs.
Only suitable for laying on the wall.

Abgabe der Dekorationselemente ausschließlich in vollen Kartons.
Éléments décoratifs uniquement livrables en cartons entiers.
Decoration elements only available in full boxes.

Bordüre, Verklebung rückseitig auf Glasfasernetz,
Bogen: 147 x 597 mm
Bordure, collée sur trame en fibre de verre à
l'envers, Feuille : 147 x 597 mm
Border, glass fibre net on reverse side,
Sheet: 147 x 597 mm

Art.	Nennmaß cote nominale nominal size cm	Herstellmaß cote de fabrication production size mm	m ² /m	Paket carton box	Palette palette pallet	Beanspr.-Gruppe groupe d'emploi wear resist. group	Norm Norme Standard	Trittsicherheit antidérapance non-slip	Preisgruppe groupe de prix price category
433651	30 x 60	297 x 597 x 10,5	5,556 St pc / m ²	6 St pc	43,197 m ²		Bla UGL	R10	B112 (m ²)
433652			23,224 kg	1,080 m ² 25,080 kg	1.003,200 kg		Bla UGL	R10	B112 (m ²)
433658	30 x 60	297 x 597 x 10,5	1,667 St pc / m	6 St pc			Bla UGL	R10	B466 (St pc)
433659			6,968 kg	3,599 m 25,080 kg			Bla UGL	R10	B466 (St pc)



anthrazit
anthracite

V2

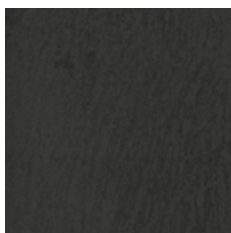

schwarz
noir
black

V1

Bodenfliese | carreau de sol | floor tile

Feinsteinzeugfliesen unglasiert | grès cérame fin vitrifié non-émaillés | porcelain stoneware tiles unglazed

30 x 60 cm



433651

anthrazit | anthracite
strukturiert, matt | structuré, mat | structured, matt

433652

schwarz | noir | black
strukturiert, matt | structuré, mat | structured, matt

Treppenfliese | nez de marche | stair tile

Feinsteinzeugfliesen unglasiert | grès cérame fin vitrifié non-émaillés | porcelain stoneware tiles unglazed

30 x 60 cm



433658

anthrazit | anthracite
strukturiert, matt | structuré, mat | structured, matt

433659

schwarz | noir | black
strukturiert, matt | structuré, mat | structured, matt

Auftragsfertigung: Rückgabe und/oder
Stornierung bestellter Ware nicht möglich.

Fabrication sur commande : il nous est
impossible d'accepter l'annulation de
commandes d'articles ou le retour d'articles.

Make-to-order production: return and/or
cancellation of ordered products not possible.



Studioaufnahme · photo prise en studio · studio photo / Architekt · architecte · architect: VSBL, Belgrad, Serbien · Belgrade, Serbie · Belgrade, Serbia /
Serie · série · series: Remix / Photo: Jochen Stüber



Souverän – bis ins kleinste Detail

Remix gestaltet eine repräsentative Atmosphäre – mit aufeinander abgestimmten Formaten, Treppenfliesen, warmen Tönen und faszinierenden Dekoren. Alleine für den Boden stehen drei Varianten Protecta-vergütete Fliesen mit R10/A zur Verfügung. Mit ihren 15 x 90 cm, 22,5 x 90 cm und 45 x 90 cm erlauben sie unterschiedliche Verlege-Spielarten: in Beige, Braun, Grau oder Anthrazit. Das glänzende Dekor Onyx (30 x 90 cm, 3er-Set) mit passender Bordüre (15 x 90 cm) in zwei Farbstellungen setzt keramisch echten Onyx-Marmor um, mit seinen wellenförmigen Farbschichten, harmonisch korrespondierend zu den Bodenfarben.

Souverain jusque dans les moindres détails

Remix permet de créer une atmosphère représentative avec des formats assortis, des carreaux d'escalier, des tons chauds et des motifs fascinants. Pour les sols, non moins de trois variantes de carreaux à traitement de surface Protecta R10/A sont disponibles. Les formats 15 x 90 cm, 22,5 x 90 cm et 45 x 90 cm, autorisent des schémas de pose variés en jouant sur les teintes beige, brun, gris et anthracite. Avec ses strates ondulées de différentes teintes, harmonieusement assorties à celles du sol, l'élément de décor brillant Onyx (30 x 90 cm, jeu de 3 carreaux) avec bordure assortie (15 x 90 cm) décliné en deux gammes de couleurs différentes restitue le marbre onyx véritable dans sa version céramique.

Superior – right down to the last detail

Remix designs a representative atmosphere – with matching sizes, stair tiles, warm shades and fascinating décors. There are three variants of Protecta-upgraded tiles with R10/A available for the floor alone. With their 15 x 90 cm, 22.5 x 90 cm and 45 x 90 cm formats, they permit various laying patterns: in beige, brown, grey or anthracite. As a harmonious match for the floor tiles, the glossy Onyx décor (30 x 90 cm, set of 3) and matching border (15 x 90 cm) in two colors is a ceramic interpretation of real onyx marble with its wave-shaped layers of color.

Art.	Nennmaß cote nominale nominal size cm	Herstellmaß cote de fabrication production size mm	m ²	Paket carton box	Palette palette pallet	Beanspr.-Gruppe groupe d'emploi wear resist. group	Norm Norme Standard	Trittsicherheit antidérapance non-slip	Preisgruppe groupe de prix price category
392904H	30 x 90	297 x 897 x 10,5	3,704 St pc	5 St pc	32,397 m ²		BIII GL		W130 (m²)
392905H			17,976 kg	1,350 m ² 24,265 kg	582,360 kg		BIII GL		W130 (m²)

Wandfliese | carreau de mur | wall tile

Steingut glasiert | faïence émaillée | earthenware glazed

30 x 90 cm



392904H

lichtgrau | gris lumière | light-grey

seidenmatt, eben | satiné, lisse | silky-matt, smooth



392905H

hellbeige | beige clair | light-beige

seidenmatt, eben | satiné, lisse | silky-matt, smooth



Art.	Nennmaß cote nominale nominal size cm	Herstellmaß cote de fabrication production size mm	m	Paket carton box	Palette palette pallet	Beanspr.-Gruppe groupe d'emploi wear resist. group	Norm Norme Standard	Trittsicherheit antidérapance non-slip	Preisgruppe groupe de prix price category
392906H	30 x 90	297 x 897 x 10,5	1,111 St pc 5,392 kg	3 St pc 2,700 m 14,559 kg			BIII GL		3 x W493 (St pc)

Dekorationselemente | éléments décoratifs | decoration elements

Dekorfliese Onyx | carreau décoratif Onyx | decorative element Onyx

Steingut glasiert | faïence émaillée | earthenware glazed

30 x 90 cm



392906H

mehrfarbig | multicolore | multi-colored
glänzend, eben | brillant, lisse | glossy, smooth
3er-Set | jeu de 3 carreaux | set of 3 tiles



Bei der von Ihnen ausgewählten Dekoration handelt es sich um ein hochwertiges Produkt aus Steingut glasiert, das mit einer besonders realistischen Steinoptik überzeugt. Die Dekoration besteht aus drei unterschiedlichen Einzelbildern. Die Anschlüsse der Einzelbilder sind bewusst frei gestaltet, und verbinden sich somit nicht in der fortlaufenden Verlegung.



Le décor que vous avez choisi est un produit en faïence émaillée de grande qualité qui convainc par son visuel de pierre particulièrement réaliste. Ce décor se compose de trois images individuelles différentes. Les rapports de chacune de ces images individuelles sont conçus de façon délibérément libre et ne se lient donc pas dans une pose continue.

The decoration you have chosen is a high quality glazed earthenware product that gives a particularly impressive and realistic stone optic: The decoration consists of 3 individual pictures. This way, each individual tile doesn't create one continuous design.

Abgabe der Dekorationselemente ausschließlich in vollen Kartons.
Éléments décoratifs uniquement livrables en cartons entiers.
Decoration elements only available in full boxes.

Art.	Nennmaß cote nominale nominal size cm	Herstellmaß cote de fabrication production size mm	m	Paket carton box	Palette palette pallet	Beanspr.-Gruppe groupe d'emploi wear resist. group	Norm Norme Standard	Trittsicherheit antidérapance non-slip	Preisgruppe groupe de prix price category
392907							Bla UGL		W518 (St pc)
392908	15 x 90	147 x 897 x 10,5	1,111 St pc	2 St pc			Bla UGL		W518 (St pc)
392909			3,277 kg	1,800 m	5,900 kg		Bla UGL		W518 (St pc)
392910							Bla UGL		W518 (St pc)

Dekorationselemente | éléments décoratifs | decoration elements

Bordüre Onyx | bordure Onyx | border Onyx

Feinsteinzeugfliesen unglasiert | grès cérame fin vitrifié non-émaillés | porcelain stoneware tiles unglazed

15 x 90 cm

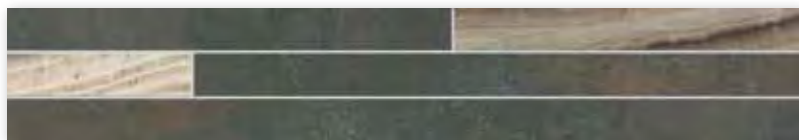

Nur für die Verlegung an der Wand im Innenbereich geeignet.

Convient uniquement pour une pose murale en intérieur.

Only suitable for laying on the wall in indoor areas.

392907

anthrazit | anthracite
eben, matt | lisse, mat | smooth, matt



Bei der von Ihnen ausgewählten Dekoration handelt es sich um ein hochwertiges Produkt aus Steingut glasiert und Feinsteinzeug. Bitte beachten Sie, dass die Steingut Einleger der Onyx Bordüren bewusst in der Farbigkeit variieren. Wir empfehlen die Dekoration vor der Verlegung auszulegen, um das Gesamtbild zu begutachten. So erhalten Sie unter ästhetischen Gesichtspunkten das beste Resultat.

Le décor que vous avez choisi est un produit en faïence émaillée et en grès cérame fin vitrifié de grande qualité. Veuillez tenir compte du fait que la variation des couleurs des cabochons de faïence des bordures Onyx est voulue. Nous recommandons de disposer le décor temporairement avant la pose définitive afin de vous donner une impression globale du résultat. C'est ainsi que vous obtiendrez le meilleur résultat du point de vue esthétique.

The decoration you have chosen is a high-quality product which combines glazed earthenware and porcelain stoneware. Please note that the earthenware inserts of the Onyx borders intentionally vary in color. We recommend to lay the decoration out prior to laying on the wall in order to get an overall impression of the design. In this way, you will obtain the best result from the aesthetic point of view.

392908

grau | gris | grey
eben, matt | lisse, mat | smooth, matt



392909

beige
eben, matt | lisse, mat | smooth, matt

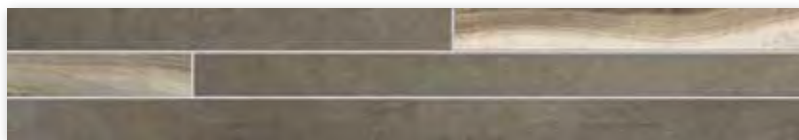

392910

braun | marron | brown
eben, matt | lisse, mat | smooth, matt

Abgabe der Dekorationselemente ausschließlich in vollen Kartons.
Éléments décoratifs uniquement livrables en cartons entiers.
Decoration elements only available in full boxes.

Bordüre, Verklebung rückseitig auf Glasfasernetz,
Bogen: 147 x 897 mm

Bordure, collée sur trame en fibre de verre à l'envers, Feuille : 147 x 897 mm

Border, glass fibre net on reverse side,
Sheet: 147 x 897 mm

Art.	Nennmaß cote nominale nominal size cm	Herstellmaß cote de fabrication production size mm	m ²	Paket carton box	Palette palette pallet	Beanspr.-Gruppe groupe d'emploi wear resist. group	Norm Norme Standard	Trittsicherheit antidérapance non-slip	Preisgruppe groupe de prix price category
434587							Bla UGL	R10/A	W183 (m ²)
434588	15 x 90	147 x 897 x 10,5	7,407 St pc	7 St pc	25,516 m ²		Bla UGL	R10/A	W183 (m ²)
434589			23,036 kg	0,945 m ² 21,770 kg	587,790 kg		Bla UGL	R10/A	W183 (m ²)
434590							Bla UGL	R10/A	W183 (m ²)
434583							Bla UGL	R10/A	W183 (m ²)
434584	22,5 x 90	222 x 897 x 10,5	4,938 St pc	5 St pc	26,326 m ²		Bla UGL	R10/A	W183 (m ²)
434585			23,060 kg	1,013 m ² 23,350 kg	607,100 kg		Bla UGL	R10/A	W183 (m ²)
434586							Bla UGL	R10/A	W183 (m ²)

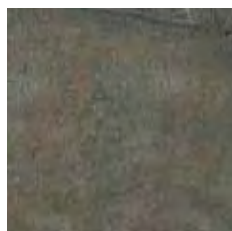

anthrazit
anthracite

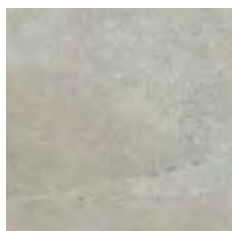

grau
gris
grey

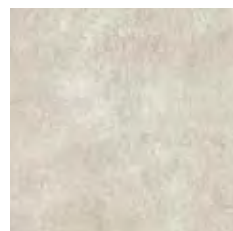

beige

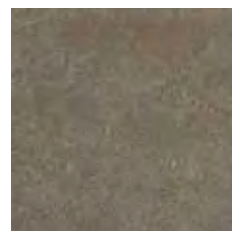

braun
brun
brown



Bodenfliese | carreau de sol | floor tile

Feinsteinzeugfliesen unglasiert | grès cérame fin vitrifié non-émaillés | porcelain stoneware tiles unglazed

15 x 90 cm Riegelformat | format de traverse | oblong format



434587

anthrazit | anthracite
strukturiert, matt | structuré, mat |
structured, matt

434589

beige
strukturiert, matt | structuré, mat |
structured, matt

434588

grau | gris | grey
strukturiert, matt | structuré, mat |
structured, matt

434590

braun | brun | brown
strukturiert, matt | structuré, mat |
structured, matt

22,5 x 90 cm Riegelformat | format de traverse | oblong format



434583

anthrazit | anthracite
strukturiert, matt | structuré, mat |
structured, matt

434585

beige
strukturiert, matt | structuré, mat |
structured, matt

434584

grau | gris | grey
strukturiert, matt | structuré, mat |
structured, matt

434586

braun | brun | brown
strukturiert, matt | structuré, mat |
structured, matt

Auftragsfertigung Riegelformate: Rückgabe und/oder Stornierung bestellter Ware nicht möglich.

Fabrication sur commande des formats en traverse : il nous est impossible d'accepter l'annulation de commandes d'articles ou le retour d'articles.
Make-to-order production in the case of oblong formats: return and/or cancellation of ordered products not possible.

Art.	Nennmaß cote nominale nominal size cm	Herstellmaß cote de fabrication production size mm	m ²	Paket carton box	Palette palette pallet	Beanspr.-Gruppe groupe d'emploi wear resist. group	Norm Norme Standard	Trittsicherheit antidérapance non-slip	Preisgruppe groupe de prix price category
434579							Bla UGL	R10/A	W161 (m ²)
434580	45 x 90	447 x 897 x 10,5	2,470 St pc	2 St pc	32,389 m ²		Bla UGL	R10/A	W161 (m ²)
434581			23,070 kg	0,810 m ²	18,680 kg		Bla UGL	R10/A	W161 (m ²)
434582							Bla UGL	R10/A	W161 (m ²)

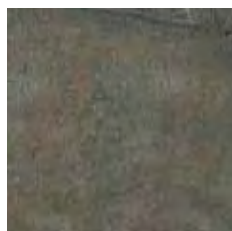

anthrazit
anthracite

V3

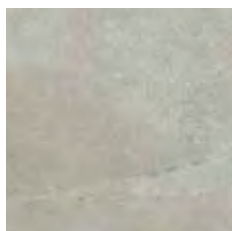

grau
gris
grey

V3

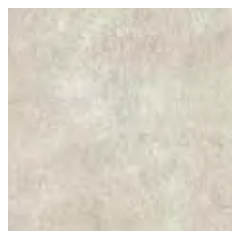

beige

V3

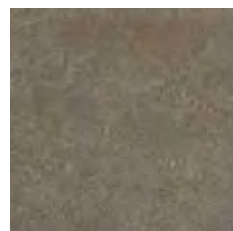

braun
brun
brown

V3

Bodenfliese | carreau de sol | floor tile

Feinsteinzeugfliesen unglasiert | grès cérame fin vitrifié non-émailés | porcelain stoneware tiles unglazed

45 x 90 cm



434579

anthrazit | anthracite
strukturiert, matt | structuré, mat |
structured, matt



434580

grau | gris | grey
strukturiert, matt | structuré, mat |
structured, matt

434581

beige
strukturiert, matt | structuré, mat |
structured, matt

434582

braun | brun | brown
strukturiert, matt | structuré, mat |
structured, matt

Remix: Verlegebeispiele | modèles de pose | laying examples

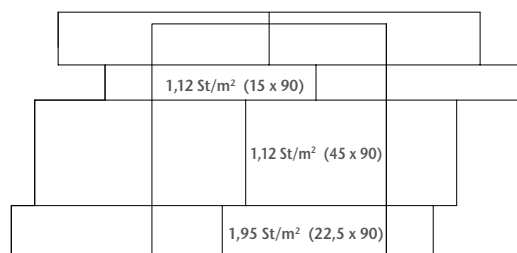
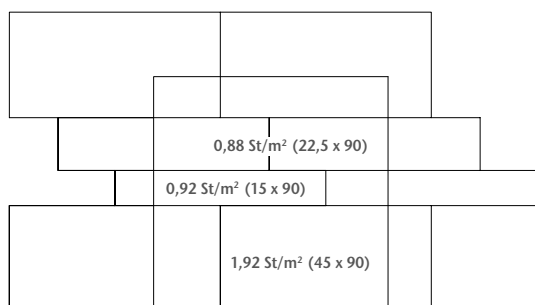

Achtung: Sonderpalette. Keine Rücknahme, kein Umtausch.
Attention : palette spéciale. Pas de retour, pas d'échange.
Please note: special pallet. No return, no exchange.

Art.	Nennmaß cote nominale nominal size cm	Herstellmaß cote de fabrication production size mm	m	Paket carton box	Palette palette pallet	Beanspr.-Gruppe groupe d'emploi wear resist. group	Norm Norme Standard	Trittsicherheit antidérapance non-slip	Preisgruppe groupe de prix price category
434591							Bla UGL	R10/A	W559 (St pc)
434592	30 x 90	297 x 897 x 10,5	1,111 St pc	4 St pc			Bla UGL	R10/A	W559 (St pc)
434593			6,910 kg	3,600 m	24,880 kg		Bla UGL	R10/A	W559 (St pc)
434594							Bla UGL	R10/A	W559 (St pc)
434599							Bla UGL		W446 (St pc)
434600	7 x 90	70 x 897 x 10,5	1,111 St pc	8 St pc			Bla UGL		W446 (St pc)
434601			1,711 kg	7,200 m	12,320 kg		Bla UGL		W446 (St pc)
434602							Bla UGL		W446 (St pc)

Treppenfliese | nez de marche | stair tile

Feinsteinzeugfliesen unglasiert | grès cérame fin vitrifié non-émaillés | porcelain stoneware tiles unglazed

30 x 90 cm



Auftragsfertigung: Rückgabe und/oder Stornierung bestellter Ware nicht möglich.

Fabrication sur commande : il nous est impossible d'accepter l'annulation de commandes d'articles ou le retour d'articles.

Make-to-order production: return and/or cancellation of ordered products not possible.

434591

anthrazit | anthracite
strukturiert, matt | structuré, mat | structured, matt



434592

grau | gris | grey
strukturiert, matt | structuré, mat | structured, matt

434593

beige
strukturiert, matt | structuré, mat | structured, matt

434594

braun | brun | brown
strukturiert, matt | structuré, mat | structured, matt

Sockel, gerundet | plinthe, arrondie | skirting, rounded

Feinsteinzeugfliesen unglasiert | grès cérame fin vitrifié non-émaillés | porcelain stoneware tiles unglazed

7 x 90 cm

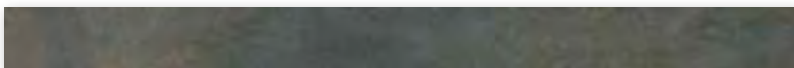

434599

anthrazit | anthracite
strukturiert, matt | structuré, mat | structured, matt



434600

grau | gris | grey
strukturiert, matt | structuré, mat | structured, matt

434601

beige
strukturiert, matt | structuré, mat | structured, matt

434602

braun | brun | brown
strukturiert, matt | structuré, mat | structured, matt

Art.	Nennmaß cote nominale nominal size cm	Herstellmaß cote de fabrication production size mm	m ²	Paket carton box	Palette palette pallet	Beanspr.-Gruppe groupe d'emploi wear resist. group	Norm Norme Standard	Trittsicherheit antidérapance non-slip	Preisgruppe groupe de prix price category
434595							Bla UGL	R10/B	W288 (m ²)
434596	5 x 5	47 x 47 x 10,5	11,111 Bögen plaques sheets	11 Bögen plaques sheets	29,700 m ²		Bla UGL	R10/B	W288 (m ²)
434597			22,222 kg	0,990 m ² 22,000 kg	660,000 kg		Bla UGL	R10/B	W288 (m ²)
434598							Bla UGL	R10/B	W288 (m ²)

Mosaik | mosaïque | mosaic

Feinsteinzeugfliesen unglasiert | grès cérame fin vitrifié non-émaillés | porcelain stoneware tiles unglazed

5 x 5 cm



434595

anthrazit | anthracite
strukturiert, matt
structuré, mat
structured, matt



434596

grau | gris | grey
strukturiert, matt
structuré, mat
structured, matt



434597

beige
strukturiert, matt
structuré, mat
structured, matt



434598

braun | brun | brown
strukturiert, matt
structuré, mat
structured, matt



Mosaik, Verklebung rückseitig auf Glasfasernetz,
Bogen: 297 x 297 mm

Mosaïque, collée sur trame en fibre de verre à l'envers,
Feuille : 297 x 297 mm

Mosaic, glass fibre net on reverse side,
Sheet: 297 x 297 mm



Studioaufnahme · photo prise en studio · studio photo / Architekt · architecte · architect: STELLWERK architekten, Dresden, Deutschland
Allemagne · Germany / Serie · série · series: Remix / Photo: Jochen Stüber

Ursprünglich und edel

Die Feinsteinzeug-Serie Sierra bringt durch ihre Farben und Oberflächenoptik Ursprünglichkeit und Natürlichkeit in den Wohnraum. Die Farbstellung Hellbeige gibt die Charakteristika von Sandstein authentisch wieder: dezente Farbschichtungen mit typischen Farbverläufen. In der Variante Anthrazit erfahren die Stäbchenmosaiken in unterschiedlichen Formaten und Schnittrichtungen eine stärkere Betonung des Mauerwerkscharakters. Passende Bodenfliesen in den Formaten 5 x 5 cm und 30 x 60 cm sind in den vier Serienfarben (neben Hellbeige und Anthrazit, Hellgrau und Weiß) verfügbar. Die Boden- und Treppenfliesen (30 x 60 cm) sind Protecta-vergütet und trittsicher R9.

Authentique et noble

De par ses teintes et sa structure de surface, la série de grès cérame Sierra apporte à vos intérieurs une touche d'authenticité et de naturel. La couleur beige clair restitue fidèlement les caractéristiques du grès : strates de couleur beige clair et nuances reconnaissables. Les bâtonnets de mosaïque aux formats et sens de coupe différents soulignent l'aspect maçonné. Les carreaux de sol assortis sont disponibles en formats différents 5 x 5 cm et 30 x 60 cm et dans quatre palettes de couleurs (beige clair et anthracite mais aussi gris clair et blanc). Les carreaux de sol et d'escalier (30 x 60 cm) ont reçu une finition Protecta et sont antidérapants R9.

Original and elegant

The porcelain stoneware Sierra series adds originality and naturalness to living areas thanks to its colors and surface look. The color light-beige authentically reflects the characteristics of sandstone and its subtle color layers with typical color variations. In the anthracite variant, block mosaics in various sizes and cutting angles emphasize the masonry character even further. Matching floor tiles in the sizes 5 x 5 cm and 30 x 60 cm are available in the four colors of the series (light-beige, anthracite, light-grey and white). The floor and stair tiles (30 x 60 cm) are Protecta-upgraded and feature non-slip R9.





Art.	Nennmaß cote nominale nominal size cm	Herstellmaß cote de fabrication production size mm	m ²	Paket carton box	Palette palette pallet	Beanspr.-Gruppe groupe d'emploi wear resist. group	Norm Norme Standard	Trittsicherheit antidérapance non-slip	Preisgruppe groupe de prix price category
059703							Bla UGL	R10	W122 (m ²)
059800	30 x 60	297 x 597 x 10,5	5,560 St pc	6 St pc	43,165 m ²		Bla UGL	R10	W122 (m ²)
059801			23,241 kg	1,079 m ² 25,080 kg	1.003,200 kg		Bla UGL	R10	W122 (m ²)
059805							Bla UGL	R10	W122 (m ²)



anthrazit
anthracite

V2



hellgrau
gris clair
light-grey

V2



hellbeige
beige clair
light-beige

V2



weiß
blanc
white

V1

Bodenfliese | carreau de sol | floor tile

Feinsteinzeugfliesen unglasiert | grès cérame fin vitrifié non-émaillés | porcelain stoneware tiles unglazed

30 x 60 cm



059703

anthrazit | anthracite
strukturiert, matt
structuré, mat
structured, matt

059800

hellgrau | gris clair | light-grey
strukturiert, matt
structuré, mat
structured, matt

059801

hellbeige | beige clair | light-beige
strukturiert, matt
structuré, mat
structured, matt

059805

weiß | blanc | white
strukturiert, matt
structuré, mat
structured, matt

Art.	Nennmaß cote nominale nominal size cm	Herstellmaß cote de fabrication production size mm	m	Paket carton box	Palette palette pallet	Beanspr.-Gruppe groupe d'emploi wear resist. group	Norm Norme Standard	Trittsicherheit antidérapance non-slip	Preisgruppe groupe de prix price category
050439							Bla UGL	R10	W476 (St pc)
059811	30 x 60	297 x 597 x 10,5	1,667 St pc	6 St pc			Bla UGL	R10	W476 (St pc)
059812			7,293 kg	3,599 m	26,250 kg		Bla UGL	R10	W476 (St pc)
059815							Bla UGL	R10	W476 (St pc)
059741							Bla UGL		W439 (St pc)
059813	7 x 60	70 x 597 x 10,5	1,667 St pc	22 St pc			Bla UGL		W439 (St pc)
059814			1,584 kg	13,197 m	20,900 kg		Bla UGL		W439 (St pc)
059816							Bla UGL		W439 (St pc)

Treppenfliese | nez de marche | stair tile

Feinsteinzeugfliesen unglasiert | grès cérame fin vitrifié non-émaillés | porcelain stoneware tiles unglazed

30 x 60 cm



Auftragsfertigung: Rückgabe und/oder Stornierung bestellter Ware nicht möglich.

Fabrication sur commande : il nous est impossible d'accepter l'annulation de commandes d'articles ou le retour d'articles.

Make-to-order production: return and/or cancellation of ordered products not possible.

050439

anthrazit | anthracite
strukturiert, matt | structuré, mat | structured, matt

059811

hellgrau | gris clair | light-grey
strukturiert, matt | structuré, mat | structured, matt

059812

hellbeige | beige clair | light-beige
strukturiert, matt | structuré, mat | structured, matt

059815

weiß | blanc | white
strukturiert, matt | structuré, mat | structured, matt

Sockel, gerundet | plinthe, arrondie | skirting, rounded

Feinsteinzeugfliesen unglasiert | grès cérame fin vitrifié non-émaillés | porcelain stoneware tiles unglazed

7 x 60 cm



059741

anthrazit | anthracite
strukturiert, matt | structuré, mat | structured, matt

059813

hellgrau | gris clair | light-grey
strukturiert, matt | structuré, mat | structured, matt

059814

hellbeige | beige clair | light-beige
strukturiert, matt | structuré, mat | structured, matt

059816

weiß | blanc | white
strukturiert, matt | structuré, mat | structured, matt

Art.	Nennmaß cote nominale nominal size cm	Herstellmaß cote de fabrication production size mm	m ²	Paket carton box	Palette palette pallet	Beanspr.-Gruppe groupe d'emploi wear resist. group	Norm Norme Standard	Trittsicherheit antidérapance non-slip	Preisgruppe groupe de prix price category
433101							Bla UGL	R10/B	W288 (m ²)
433102	5 x 5	47 x 47 x 10,5	11,111 Bögen plaques sheets	11 Bögen plaques sheets	29,700 m ²		Bla UGL	R10/B	W288 (m ²)
433109			22,222 kg	0,990 m ² 22,000 kg	666,000 kg		Bla UGL	R10/B	W288 (m ²)
433110							Bla UGL	R10/B	W288 (m ²)
229659							Bla UGL	R10	W383 (m ²)
221379	30 x 30	298 x 298 x 10,5	11,110 Bögen plaques sheets	11 Bögen plaques sheets	29,703 m ²		Bla UGL	R10	W383 (m ²)
221380			24,220 kg	0,990 m ² 23,980 kg	719,400 kg		Bla UGL	R10	W383 (m ²)
221381							Bla UGL	R10	W383 (m ²)

Mosaik | mosaïque | mosaic

Feinsteinzeugfliesen unglasiert | grès cérame fin vitrifié non-émaillés | porcelain stoneware tiles unglazed

5 x 5 cm

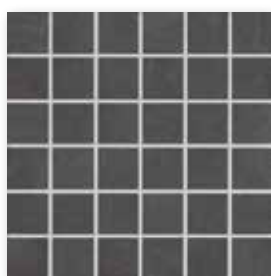

433101
anthrazit | anthracite
strukturiert, matt
structuré, mat
structured, matt

V2



433102
hellgrau | gris clair | light-grey
strukturiert, matt
structuré, mat
structured, matt

V2



433109
hellbeige | beige clair | light-beige
strukturiert, matt
structuré, mat
structured, matt

V2

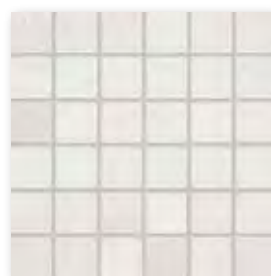

433110
weiß | blanc | white
strukturiert, matt
structuré, mat
structured, matt

V1



Mosaik, Verklebung
rückseitig auf
Glasfasernetz, Bogen:
297 x 297 mm

Mosaïque, collée sur
trame en fibre de verre
à l'envers, Feuille :
297 x 297 mm

Mosaic, glass fibre net
on reverse side, Sheet:
297 x 297 mm

Riegelmosaik | Mosaïques en traverse | oblong mosaic

Feinsteinzeugfliesen unglasiert | grès cérame fin vitrifié non-émaillés | porcelain stoneware tiles unglazed

30 x 30 cm



229659
anthrazit | anthracite
strukturiert, matt
structuré, mat
structured, matt

V2



221379
hellgrau | gris clair | light-grey
strukturiert, matt
structuré, mat
structured, matt

V2



221380
hellbeige | beige clair | light-beige
strukturiert, matt
structuré, mat
structured, matt

V2



221381
weiß | blanc | white
strukturiert, matt
structuré, mat
structured, matt

V1



Verklebung rückseitig auf Glasfasernetz,
Bogen: 298 x 298 mm

Collage sur trame en fibre de verre à l'envers,
Feuille : 298 x 298 mm

Glass fibre net on reverse side,
Sheet: 298 x 298 mm

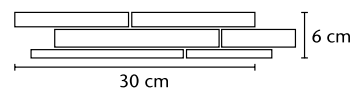

Vorschlag für Bordüregestaltung:
Aus einem Mosaikbogen können fünf
Bordüren gemäß beigefügter Skizze
entnommen werden = 1,5 lfm.

Proposition pour l'aménagement de
bordures : Une feuille en mosaïques
peut être divisée en cinq bordures
selon le croquis ci-joint = 1,5 ml.

Proposal for borders design: five
borders can be taken from one mosaic
sheet according to the enclosed sketch
= 1.5 lin. m.





Studioaufnahme · photo prise en studio · studio photo / Architekt · architecte · architect: STELLWERK architekten, Dresden, Deutschland
Allemagne · Germany / Serie · série · series: Sky / Photo: Jochen Stüber



Luzid, heiter – und ein Hauch Dynamik

Mit Sky verwandeln sich Bäder in lichthelle Räume. Für mehr Tiefenwirkung sorgt die Oberflächenvariante „glänzend“ – alternativ erlaubt „matt“ eine naturnahe Gestaltung. Mit der reinigungsfreundlichen Hytect-Oberfläche der Wandfliesen, zwei Farben – Grau oder Beige – sowie einem Format mit 30 x 90 cm gibt Sky ein klares und selbstbewusstes Statement ab. Als passende Bodenserie empfiehlt sich Oak, aus der auch das skandinavisch-dynamische Dekor Verso in 10 x 90 cm geschnitten wurde. Dekor und Boden sind in Eiche creme, Eiche natur oder Eiche anthrazit erhältlich.

Lucidité, entrain et un soupçon de dynamisme

Sky transforme la salle de bains en une pièce lumineuse. La touche de profondeur est apportée par la finition de surface « brillante » ou la finition « mat » pour un rendu naturel. Avec la surface Hytect facile à nettoyer des carreaux de mur, deux couleurs – gris ou beige – et un format de 30 x 90 cm, Sky fait une déclaration claire et avec une grande assurance. Le choix de Oak comme gamme de sol complémentaire paraît comme une évidence, tout comme celui de l'élément de décor dynamique Verso de 10 x 90 cm, d'inspiration scandinave, issu de la même gamme. L'élément de décoration et les carreaux de sol sont disponibles dans les teintes chêne crème, chêne naturel et chêne anthracite.

Lucid, cheerful – and a touch of dynamism

Sky transforms bathrooms into ultra-bright spaces. More depth is effected by the “glossy” surface variant, while “matt” permits a more natural design. With the easy-clean Hytect surface of the wall tiles, two colors – grey or beige – and a format of 30 x 90 cm, Sky makes a clear and self-confident statement. Oak is ideal as a matching floor series – from which the dynamic Scandinavian-style Verso decor in 10 x 90 cm is also cut. Both the decor and the floor tiles are available in cream oak, natural oak or anthracite oak.

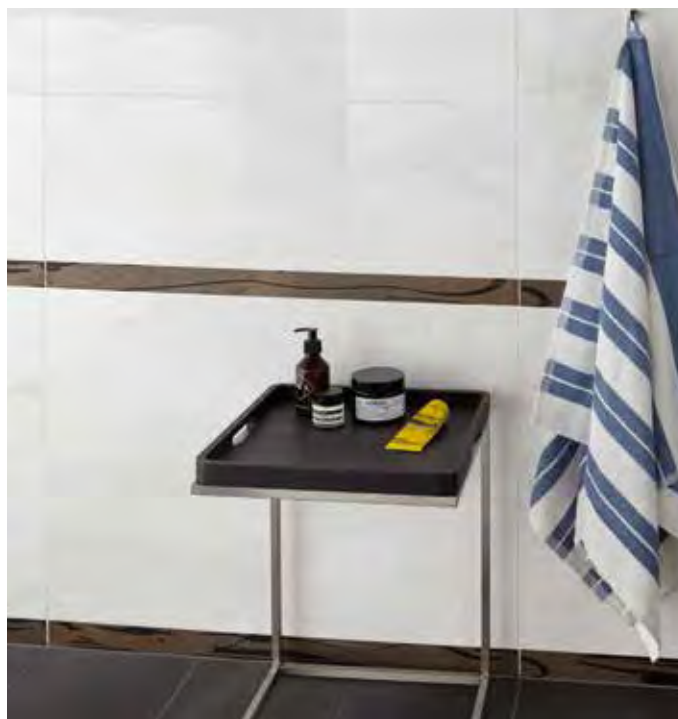

Art.	Nennmaß cote nominale nominal size cm	Herstellmaß cote de fabrication production size mm	m ²	Paket carton box	Palette palette pallet	Beanspr.-Gruppe groupe d'emploi wear resist. group	Norm Norme Standard	Trittsicherheit antidérapance non-slip	Preisgruppe groupe de prix price category
392911H							BIII GL	W130 (m²)	
392912H	30 x 90	297 x 897 x 10,5	3,704 St pc	5 St pc	32,397 m ²		BIII GL	W130 (m²)	
392913H			17,976 kg	1,350 m ² 24,265 kg	582,360 kg		BIII GL	W130 (m²)	
392914H							BIII GL	W130 (m²)	

Wandfliese | carreau de mur | wall tile
Steingut glasiert | faïence émaillée | earthenware glazed

30 x 90 cm



392911H
grau | gris | grey
glänzend, eben | brillant, lisse | glossy, smooth



392912H
grau | gris | grey
seidenmatt, eben | satinée, lisse | silky matt, smooth



392913H
beige
glänzend, eben | brillant, lisse | glossy, smooth



392914H
beige
seidenmatt, eben | satinée, lisse | silky matt, smooth

Bodenempfehlung Serie Oak, siehe Seite 156.
Recommandation relative au sol, série Oak, voir page 156.
Recommended floor tiles: series Oak, see page 156.

Art.	Nennmaß cote nominale nominal size cm	Herstellmaß cote de fabrication production size mm	m	Paket carton box	Palette palette pallet	Beanspr.-Gruppe groupe d'emploi wear resist. group	Norm Norme Standard	Trittsicherheit antidérapance non-slip	Preisgruppe groupe de prix price category	
392918	5 x 90	47 x 897 x 10,5	1,111 St pc	3 St pc					Bla UGL	W446 (St pc)
392919			1,161 kg	2,700 m 3,135 kg					Bla UGL	W446 (St pc)
392915H	10 x 90	97 x 897 x 8							Alb UGL	W534 (St pc)
392916H			1,111 St pc	2 St pc					Alb UGL	W534 (St pc)
392917H			1,667 kg	1,800 m 3,000 kg					Alb UGL	W534 (St pc)

Dekorationselemente | éléments décoratifs | decoration elements

Bordüre Paint | bordure Paint | border Paint

Feinsteinzeugfliesen unglasiert | grès cérame fin vitrifié non-émaillés | porcelain stoneware tiles unglazed

5 x 90 cm

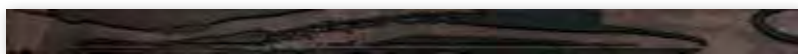

392918

grau | gris | grey
strukturiert, matt | structuré, mat | structured, matt



Nur für die Verlegung an der Wand im Innenbereich geeignet.

Convient uniquement pour une pose murale en intérieur.

Only suitable for laying on the wall in indoor areas.



392919

beige
strukturiert, matt | structuré, mat | structured, matt



Bordüre Verso | bordure Verso | border Verso

Feinsteinzeugfliesen unglasiert | grès cérame fin vitrifié non-émaillés | porcelain stoneware tiles unglazed

10 x 90 cm



392916H

Eiche natur | chêne nature | natural oak
strukturiert, matt | structuré, mat | structured, matt



Nur für die Verlegung an der Wand geeignet. Materialbedingt gibt es einen kleinen Höhenunterschied zwischen Dekoration und Flächenware. Bitte diesen Unterschied bei der Verlegung durch einen höheren Kleberauftrag im Bereich der Dekoration ausgleichen.

Pose murale uniquement. La différence d'épaisseur entre les matériaux entraîne une légère différence de niveau entre l'élément de décoration et le reste des carreaux. Cette différence sera comblée facilement par l'application d'une quantité plus importante de colle au niveau du décor.



392915H

Eiche creme | chêne crème | cream oak
strukturiert, matt | structuré, mat | structured, matt



Only suitable for laying on the wall. Due to the material properties, there is a slight difference in height between the décor and the remaining tiles. Please compensate for this height difference by applying more adhesive to the décor tile.



392917H

Eiche anthrazit | chêne anthracite | anthracite oak
strukturiert, matt | structuré, mat | structured, matt

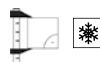

Abgabe der Dekorationselemente ausschließlich in vollen Kartons.
Éléments décoratifs uniquement livrables en cartons entiers.
Decoration elements only available in full boxes.

Natürlich ausdrucksstark

Solid Rock – schon dieser Name ist ein klares Statement. Und die robuste Qualität dieser Serie ist fast in Stein gemeißelt. Solid Rock hebt die Grenzen zwischen Innen und Außen auf. Rein ästhetisch, weil sie die Kraft der Natur in Bäder, Foyers und alle anderen Räume bringt. Grenzenlose Möglichkeiten bieten sich aber auch bei der Verlegung. Weil Innenfliesen im Verbund mit Solid Rock Terrassenplatten nahtlose Übergänge zwischen Drinnen und Draußen realisieren. Ein Highlight für Hotels und Restaurants, aber auch im privaten Wohnbereich. Die lebendige Struktur der Fliesen akzentuiert Räume klar und stringent. Der Mauerverbund Move erweitert die gestalterischen Freiheiten für Architekten und Planer noch einmal. Das liegt an den verschiedenen und sorgfältig ausgewählten Farbtönen, in denen diese ästhetisch wirklich atemberaubende Fliese lieferbar ist. Solid Rock ist Protecta vergütet und damit unempfindlich gegen Schmutz und Flecken.

Naturellement expressif

Solid Rock – ce nom seul est une déclaration claire. Et la qualité robuste de cette série est presque gravée dans le marbre. Solid Rock efface les frontières entre l'intérieur et l'extérieur. Purement esthétique, car il fait entrer la force de la nature dans les salles de bains, les foyers et toutes les autres pièces. Mais les possibilités sont également illimitées en matière de pose. Car les carreaux intérieurs combinés aux dalles de terrasse Solid Rock créent des transitions transparentes entre l'intérieur et l'extérieur. Un atout pour les hôtels et les restaurants, mais aussi pour les espaces de vie privés. La structure vivante des carreaux met en valeur les pièces de manière claire et rigoureuse. L'assemblage Move élargit encore la liberté de conception pour les architectes et les concepteurs. Ceci est dû aux différentes teintes soigneusement sélectionnées dans lesquelles ce carreau d'une grande beauté esthétique est disponible. Solid Rock a reçu un traitement Protecta et est donc insensible à la saleté et aux taches.

Naturally expressive

Solid Rock – this name alone is a clear statement. And the robust quality of this series is almost set in stone. Solid Rock eliminates the boundaries between inside and outside. Purely aesthetically, because it brings the power of nature into bathrooms, foyers and all other rooms. But there are also unlimited possibilities when it comes to laying. Because interior tiles in combination with Solid Rock patio tiles create seamless transitions between indoors and outdoors. A highlight for hotels and restaurants, but also in private living areas. The lively structure of the tiles accentuates rooms clearly and stringently. The Move wall bond further expands the design freedom for architects and planners. This is due to the different and carefully selected colour shades in which this aesthetically truly stunning tile is available. Solid Rock is Protecta-upgraded and thus resistant to dirt and stains.





3D-Rendering / Architekt · architecte · architect: VSBL, Belgrad, Serbien · Belgrade, Serbie · Belgrade, Serbia / Serie · série · series: Solid Rock

Art.	Nennmaß cote nominale nominal size cm	Herstellmaß cote de fabrication production size mm	m ²	Paket carton box	Palette palette pallet	Beanspr.-Gruppe groupe d'emploi wear resist. group	Norm Norme Standard	Trittsicherheit antidérapance non-slip	Preisgruppe groupe de prix price category
430857							Bla UGL	R10/A+B	W183 (m ²)
430858	5 x 60	46 x 596 x 9	33,333 St pc	39 St pc	46,800 m ²		Bla UGL	R10/A+B	W183 (m ²)
430859			19,899 kg	1,170 m ² 23,283 kg	931,320 kg		Bla UGL	R10/A+B	W183 (m ²)
430860							Bla UGL	R10/A+B	W183 (m ²)
430861							Bla UGL	R10/A+B	W183 (m ²)
430862	10 x 60	96 x 596 x 9	16,667 St pc	17 St pc	40,799 m ²		Bla UGL	R10/A+B	W183 (m ²)
430863			20,283 kg	1,020 m ² 20,689 kg	827,560 kg		Bla UGL	R10/A+B	W183 (m ²)
430864							Bla UGL	R10/A+B	W183 (m ²)



silver



mud grey



natural grey

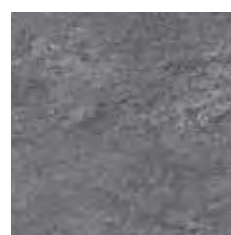

deep grey



Wand- und Bodenfliese | Carreau de mur et de sol | Wall and floor tile

Feinsteinzeugplatten unglasiert | grès fin non-émaillés | porcelain stoneware tiles unglazed

5 x 60 cm



430857

silver
strukturiert, matt
structuré, mat
structured, matt

430859

natural grey
strukturiert, matt
structuré, mat
structured, matt

430858

mud grey
strukturiert, matt
structuré, mat
structured, matt

430860

deep grey
strukturiert, matt
structuré, mat
structured, matt

Auftragsfertigung: Rückgabe und/oder Stornierung bestellter Ware nicht möglich.

Fabrication sur commande : il nous est impossible d'accepter l'annulation de commandes d'articles ou le retour d'articles.

Make-to-order production: return and/or cancellation of ordered products not possible.

10 x 60 cm



430861

silver
strukturiert, matt
structuré, mat
structured, matt

430863

natural grey
strukturiert, matt
structuré, mat
structured, matt

430862

mud grey
strukturiert, matt
structuré, mat
structured, matt

430864

deep grey
strukturiert, matt
structuré, mat
structured, matt

Auftragsfertigung: Rückgabe und/oder Stornierung bestellter Ware nicht möglich.

Fabrication sur commande : il nous est impossible d'accepter l'annulation de commandes d'articles ou le retour d'articles.

Make-to-order production: return and/or cancellation of ordered products not possible.

Art.	Nennmaß cote nominale nominal size cm	Herstellmaß cote de fabrication production size mm	m ²	Paket carton box	Palette palette pallet	Beanspr.-Gruppe groupe d'emploi wear resist. group	Norm Norme Standard	Trittsicherheit antidérapance non-slip	Preisgruppe groupe de prix price category
430865							Bla UGL	R10/A+B	W161 (m ²)
430866	15 x 60	146 x 596 x 9	11,111 St pc	13 St pc	46,800 m ²		Bla UGL	R10/A+B	W161 (m ²)
430867			19,899 kg	1,170 m ²	23,283 kg	931,320 kg	Bla UGL	R10/A+B	W161 (m ²)
430868							Bla UGL	R10/A+B	W161 (m ²)
430869							Bla UGL	R10/A+B	W72 (m ²)
430870	30 x 60	297 x 596 x 9	5,556 St pc	7 St pc	50,396 m ²		Bla UGL	R10/A+B	W72 (m ²)
430871			19,841 kg	1,260 m ²	25,000 kg	999,880 kg	Bla UGL	R10/A+B	W72 (m ²)
430872							Bla UGL	R10/A+B	W72 (m ²)
430873							Bla UGL	R10/A+B	W84 (m ²)
430874	60 x 60	596 x 596 x 9	2,778 St pc	3 St pc	43,197 m ²		Bla UGL	R10/A+B	W84 (m ²)
430875			19,288 kg	1,080 m ²	20,829 kg	833,160 kg	Bla UGL	R10/A+B	W84 (m ²)
430876							Bla UGL	R10/A+B	W84 (m ²)

Wand- und Bodenfliese | Carreau de mur et de sol | Wall and floor tile

Feinsteinzeugplatten unglasiert | grès fin non-émaillés | porcelain stoneware tiles unglazed

15 x 60 cm



430865
silver
strukturiert, matt
structuré, mat
structured, matt

430867
natural grey
strukturiert, matt
structuré, mat
structured, matt

430866
mud grey
strukturiert, matt
structuré, mat
structured, matt

430868
deep grey
strukturiert, matt
structuré, mat
structured, matt

Auftragsfertigung: Rückgabe und/oder Stornierung bestellter Ware nicht möglich.

Fabrication sur commande : il nous est impossible d'accepter l'annulation de commandes d'articles ou le retour d'articles.

Make-to-order production: return and/or cancellation of ordered products not possible.

30 x 60 cm



430869
silver
strukturiert, matt
structuré, mat
structured, matt

430871
natural grey
strukturiert, matt
structuré, mat
structured, matt

430870
mud grey
strukturiert, matt
structuré, mat
structured, matt

430872
deep grey
strukturiert, matt
structuré, mat
structured, matt

60 x 60 cm



430873
silver
strukturiert, matt
structuré, mat
structured, matt

430875
natural grey
strukturiert, matt
structuré, mat
structured, matt

430874
mud grey
strukturiert, matt
structuré, mat
structured, matt

430876
deep grey
strukturiert, matt
structuré, mat
structured, matt

Art.	Nennmaß cote nominale nominal size cm	Herstellmaß cote de fabrication production size mm	m ²	Paket carton box	Palette palette pallet	Beanspr.-Gruppe groupe d'emploi wear resist. group	Norm Norme Standard	Trittsicherheit antidérapance non-slip	Preisgruppe groupe de prix price category
430877							Bla UGL	R10/A+B	W124 (m ²)
430878	60 x 120	596 x 1194 x 9	1,388 St pc	2 St pc	50,432 m ²		Bla UGL	R10/A+B	W124 (m ²)
430879			21,514 / kg	1,44 m ² 31,000 kg	1.085,000 kg		Bla UGL	R10/A+B	W124 (m ²)
430880							Bla UGL	R10/A+B	W124 (m ²)



silver



mud grey



natural grey



deep grey



Wand- und Bodenfliese | Carreau de mur et de sol | Wall and floor tile

Feinsteinzeugplatten unglasiert | grès fin non-émaillés | porcelain stoneware tiles unglazed

60 x 120 cm



430877

silver
strukturiert, matt
structuré, mat
structured, matt

430878

mud grey
strukturiert, matt
structuré, mat
structured, matt

430879

natural grey
strukturiert, matt
structuré, mat
structured, matt

430880

deep grey
strukturiert, matt
structuré, mat
structured, matt

Art.	Nennmaß cote nominale nominal size cm	Herstellmaß cote de fabrication production size mm	m ²	Paket carton box	Palette palette pallet	Beanspr.-Gruppe groupe d'emploi wear resist. group	Norm Norme Standard	Trittsicherheit antidérapance non-slip	Preisgruppe groupe de prix price category
430881							Bla UGL	R11/B	W143 (m ²)
430882	60 x 60	596 x 596 x 20	2,778 St pc	2 St pc	21,598 m ²		Bla UGL	R11/B	W143 (m ²)
430883			47,226 kg	0,720 m ² 34,000 kg	1.020,000 kg		Bla UGL	R11/B	W143 (m ²)
430884							Bla UGL	R11/B	W143 (m ²)
430885							Bla UGL	R11/B	W161 (m ²)
430886	60 x 120	596 x 1194 x 20	1,388 St pc	1 St pc	25,200 m ²		Bla UGL	R11/B	W161 (m ²)
430887			45,110 kg	0,720 m ² 32,500 kg	1.137,500 kg		Bla UGL	R11/B	W161 (m ²)
430888							Bla UGL	R11/B	W161 (m ²)

Terrassenplatte | dalle de terrasse | patio tile*

Feinsteinzeugfliesen unglasiert | grès cérame fin vitrifié non-émaillés | porcelain stoneware tiles unglazed

60 x 60 cm



430881
silver
strukturiert, matt
structuré, mat
structured, matt

430882
mud grey
strukturiert, matt
structuré, mat
structured, matt

430883
natural grey
strukturiert, matt
structuré, mat
structured, matt

430884
deep grey
strukturiert, matt
structuré, mat
structured, matt

60 x 120 cm **



430885
silver
strukturiert, matt
structuré, mat
structured, matt

430886
mud grey
strukturiert, matt
structuré, mat
structured, matt

430887
natural grey
strukturiert, matt
structuré, mat
structured, matt

430888
deep grey
strukturiert, matt
structuré, mat
structured, matt

* Hohes Gewicht! Karton bitte nur zu Zweit transportieren.
* Poids élevé ; a transporter par deux personnes seulement.
* High weight only to carry with two persons.

** Achtung: Sonderpalette. Keine Rücknahme, kein Umtausch.
** Attention : palette spéciale. Pas de retour, pas d'échange.
** Please note: special pallet. No return, no exchange.

Art.	Nennmaß cote nominale nominal size cm	Herstellmaß cote de fabrication production size mm	m	Paket carton box	Palette palette pallet	Beanspr.-Gruppe groupe d'emploi wear resist. group	Norm Norme Standard	Trittsicherheit antidérapance non-slip	Preisgruppe groupe de prix price category
430897							Bla UGL	R10/A+B	W488 (St pc)
430888	15 x 60	148 x 598 x 9	2,000 St pc	2 St pc			Bla UGL	R10/A+B	W488 (St pc)
430889			2,780 / kg	1,060 m	2,780 / kg		Bla UGL	R10/A+B	W488 (St pc)
430900							Bla UGL	R10/A+B	W488 (St pc)

Dekorationselemente | éléments décoratifs | decoration elements

Bordüre Move | bordure Move | border Move

Feinsteinzeugfliesen unglasiert | grès cérame fin vitrifié non-émaillés | porcelain stoneware tiles unglazed

15 x 60 cm



430897
silver
strukturiert, matt
structuré, mat
structured, matt

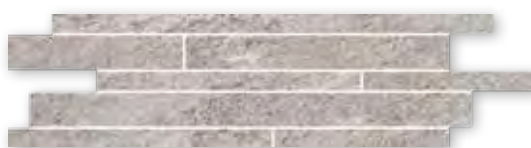

430898
mud grey
strukturiert, matt
structuré, mat
structured, matt



430899
natural grey
strukturiert, matt
structuré, mat
structured, matt



430900
deep grey
strukturiert, matt
structuré, mat
structured, matt

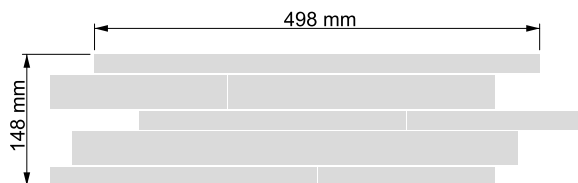

Verklebung rückseitig auf Glasfasernetz,
Bogen: 148 x 598 mm
Collée sur trame en fibre de verre à l'envers,
Feuille: 148 x 598 mm
Glass fibre net on reverse side,
Sheet: 148 x 598 mm

Abgabe der Dekorationselemente ausschließlich in vollen Kartons.
Éléments décoratifs uniquement livrables en cartons entiers.
Decoration elements only available in full boxes.

Art.	Nennmaß cote nominale nominal size cm	Herstellmaß cote de fabrication production size mm	m	Paket carton box	Palette palette pallet	Beanspr.-Gruppe groupe d'emploi wear resist. group	Norm Norme Standard	Trittsicherheit antidérapance non-slip	Preisgruppe groupe de prix price category
430893							Bla UGL	R10/A+B	W473 (St pc)
430894	30 x 60	297 x 596 x 9	1,667 St pc	7 St pc			Bla UGL	R10/A+B	W473 (St pc)
430895			5,973 / kg	4,199 m	25,081 kg		Bla UGL	R10/A+B	W473 (St pc)
430896							Bla UGL	R10/A+B	W473 (St pc)
430889							Bla UGL		W439 (St pc)
430890	7x 60	70 x 596 x 9	1,667 St pc	22 St pc			Bla UGL		W439 (St pc)
430891			1,357 / kg	13,197 m	17,908 kg		Bla UGL		W439 (St pc)
430892							Bla UGL		W439 (St pc)

Treppenfliese | nez de marche | stair tile

Feinsteinzeugfliesen unglasiert | grès cérame fin vitrifié non-émaillés | porcelain stoneware tiles unglazed

30 x 60 cm

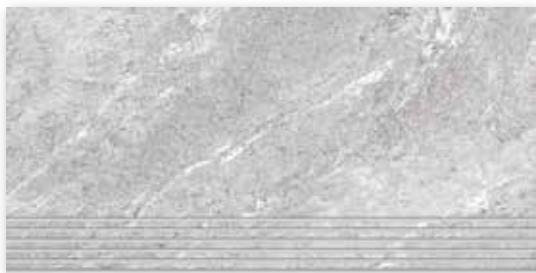

430893
silver
strukturiert, matt
structuré, mat
structured, matt

430894
mud grey
strukturiert, matt
structuré, mat
structured, matt

430895
natural grey
strukturiert, matt
structuré, mat
structured, matt

430896
deep grey
strukturiert, matt
structuré, mat
structured, matt

Auftragsfertigung: Rückgabe und/oder Stornierung bestellter Ware nicht möglich.

Fabrication sur commande : il nous est impossible d'accepter l'annulation de commandes d'articles ou le retour d'articles.

Make-to-order production: return and/or cancellation of ordered products not possible.

Sockel, gerundet | plinthe, arrondie | skirting, rounded

Feinsteinzeugfliesen unglasiert | grès cérame fin vitrifié non-émaillés | porcelain stoneware tiles unglazed

7 x 60 cm



430889
silver
strukturiert, matt
structuré, mat
structured, matt

430890
mud grey
strukturiert, matt
structuré, mat
structured, matt

430891
natural grey
strukturiert, matt
structuré, mat
structured, matt

430892
deep grey
strukturiert, matt
structuré, mat
structured, matt

Art.	Nennmaß cote nominale nominal size cm	Herstellmaß cote de fabrication production size mm	m ²	Paket carton box	Palette palette pallet	Beanspr.-Gruppe groupe d'emploi wear resist. group	Norm Norme Standard	Trittsicherheit antidérapance non-slip	Preisgruppe groupe de prix price category
430853							Bla UGL	R10/A+B	W288 (m ²)
430854	5 x 5	47 x 47 x 9	11,111 Bögen plaques sheets	12 Bögen plaques sheets	32,400 m ²		Bla UGL	R10/A+B	W288 (m ²)
430855			19,833 kg	1,080 m ² 21,420 kg	642,600 kg		Bla UGL	R10/A+B	W288 (m ²)
430856							Bla UGL	R10/A+B	W288 (m ²)

Mosaik | mosaïque | mosaic

Feinsteinzeugfliesen unglasiert | grès cérame fin vitrifié non-émaillés | porcelain stoneware tiles unglazed

5 x 5 cm



430853
silver
strukturiert, matt
structuré, mat
structured, matt



430854
mud grey
strukturiert, matt
structuré, mat
structured, matt



430855
natural grey
strukturiert, matt
structuré, mat
structured, matt

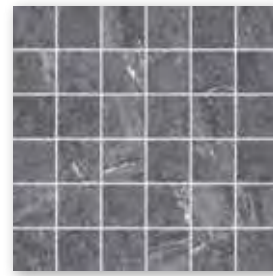

430856
deep grey
strukturiert, matt
structuré, mat
structured, matt



Mosaik, Verklebung rückseitig auf Glasfasernetz
Bogen: 297 x 297 mm

Mosaïque, collée sur trame en fibre de verre à
l'envers, Feuille: 297 x 297 mm

Mosaic, glass fibre net on reverse side
Sheet: 297 x 297 mm



3D-Rendering / Architekt · architecte · architect: VSBL, Belgrad, Serbien · Belgrade, Serbie · Belgrade, Serbia / Serie · série · series: Solid Rock

Urbaner Chic in trendiger Beton-Optik

Vier Farben, zwei Formate – so puristisch versteht Soul zu überzeugen. Für ein zeitloses Interieur oder einen Style mit engem Bezug zur Natur. Je nach Farbstellung lassen sich hier unterschiedliche Wirkungen erzielen. In Braun, Anthrazit, Basalt, Zementgrau stehen Fliesen in klassischen 30 x 60 cm und quadratischen 60 x 60 cm mit Trittsicherheit R9 zur Verfügung. Ergänzt wird die Formatpalette durch passende Treppenfliesen in 30 x 60 cm, Sockel und 5 x 5 cm-Mosaik – für eine durchgehend einheitliche Gestaltung an Wand, Boden und in Nassbereichen.

Le chic urbain du look béton

Quatre teintes, deux formats suffisent à Soul pour convaincre. Pour un intérieur intemporel ou un style proche de la nature. Différentes combinaisons de teintes permettent d'obtenir différents effets. Les carreaux antidérapants R9 sont disponibles en brun, anthracite, basalte et gris ciment au format rectangulaire de 30 x 60 cm ou carré de 60 x 60 cm. La gamme est complétée par les nez de marche de 30 x 60 cm, les plinthes et les mosaïques de 5 x 5 cm pour une conception uniforme des murs, sols et espaces humides.

Urban chic with a trendy concrete look

Available in four colors and two formats – Soul is convincingly puristic. For a timeless interior or a style with a close connection to nature. Depending on the colors, various effects can be achieved here. Tiles in classic 30 x 60 cm and square 60 x 60 cm formats with R9 slip resistance are available in brown, anthracite, basalt and cement-grey. The range of formats is supplemented by matching stair tiles in 30 x 60 cm, skirtings and 5 x 5 cm mosaics – for a consistently uniform design on walls, floors and in wet areas.





Studioaufnahme · photo prise en studio · studio photo / Architekt · architecte · architect: STELLWERK architekten, Dresden, Deutschland
Allemagne · Germany / Serie · série · series: Soul / Photo: Jochen Stüber

Art.	Nennmaß cote nominale nominal size cm	Herstellmaß cote de fabrication production size mm	m ²	Paket carton box	Palette palette pallet	Beanspr.-Gruppe groupe d'emploi wear resist. group	Norm Norme Standard	Trittsicherheit antidérapance non-slip	Preisgruppe groupe de prix price category
434854							Bla UGL	R9	W84 (m ²)
434855	30 x 60	297 x 597 x 10,5	5,556 St pc	6 St pc	43,197 m ²		Bla UGL	R9	W84 (m ²)
434856			23,224 kg	1,080 m ² 25,080 kg	1.003,200 kg		Bla UGL	R9	W84 (m ²)
434857							Bla UGL	R9	W84 (m ²)
434858							Bla UGL	R9	W91 (m ²)
434859	60 x 60	597 x 597 x 10,5	2,778 St pc	3 St pc	38,877 m ²		Bla UGL	R9	W91 (m ²)
434860			23,769 kg	1,080 m ² 25,668 kg	924,048 kg		Bla UGL	R9	W91 (m ²)
434861							Bla UGL	R9	W91 (m ²)



braun
brun
brown

V4



anthrazit
anthracite

V4



basalt
basalte
basalt

V3



zementgrau
gris ciment
cement-grey

V3

Boden- und Wandfliese | carreau de sol et de mur | floor and wall tile

Feinsteinzeugfliesen unglasiert | grès cérame fin vitrifié non-émaillés | porcelain stoneware tiles unglazed

30 x 60 cm



434854

braun | brun | brown
eben, matt | lisse, mat | smooth, matt



434855

anthrazit | anthracite
eben, matt | lisse, mat | smooth, matt

434856

basalt | basalte | basalt
eben, matt | lisse, mat | smooth, matt

434857

zementgrau | gris ciment | cement-grey
eben, matt | lisse, mat | smooth, matt

60 x 60 cm



434858

braun | brun | brown
eben, matt | lisse, mat | smooth, matt



434859

anthrazit | anthracite
eben, matt | lisse, mat | smooth, matt

434860

basalt | basalte | basalt
eben, matt | lisse, mat | smooth, matt

434861

zementgrau | gris ciment | cement-grey
eben, matt | lisse, mat | smooth, matt

Art.	Nennmaß cote nominale nominal size cm	Herstellmaß cote de fabrication production size mm	m	Paket carton box	Palette palette pallet	Beanspr.-Gruppe groupe d'emploi wear resist. group	Norm Norme Standard	Trittsicherheit antidérapance non-slip	Preisgruppe groupe de prix price category
434862							Bla UGL	R9	W473 (St pc)
434863	30 x 60	297 x 597 x 10,5	1,667 St pc	6 St pc			Bla UGL	R9	W473 (St pc)
434864			6,968 kg	3,599 m	25,080 kg		Bla UGL	R9	W473 (St pc)
434865							Bla UGL	R9	W473 (St pc)
434866							Bla UGL		W439 (St pc)
434867	7 x 60	70 x 597 x 10,5	1,667 St pc	22 St pc			Bla UGL		W439 (St pc)
434868			1,584 kg	13,197 m	20,900 kg		Bla UGL		W439 (St pc)
434869							Bla UGL		W439 (St pc)

Treppenfliese | nez de marche | stair tile

Feinsteinzeugfliesen unglasiert | grès cérame fin vitrifié non-émaillés | porcelain stoneware tiles unglazed

30 x 60 cm



434862

braun | brun | brown
eben, matt | lisse, mat | smooth, matt



434863

anthrazit | anthracite
eben, matt | lisse, mat | smooth, matt

434864

basalt | basalte | basalt
eben, matt | lisse, mat | smooth, matt

434865

zementgrau | gris ciment | cement-grey
eben, matt | lisse, mat | smooth, matt

Auftragsfertigung: Rückgabe und/oder
Stornierung bestellter Ware nicht möglich.

Fabrication sur commande : il nous est
impossible d'accepter l'annulation de
commandes d'articles ou le retour d'articles.

Make-to-order production: return and/or
cancellation of ordered products not possible.

Sockel, gerundet | plinthe, arrondie | skirting, rounded

Feinsteinzeugfliesen unglasiert | grès cérame fin vitrifié non-émaillés | porcelain stoneware tiles unglazed

7 x 60 cm



434866

braun | brun | brown
eben, matt | lisse, mat | smooth, matt



434867

anthrazit | anthracite
eben, matt | lisse, mat | smooth, matt

434868

basalt | basalte | basalt
eben, matt | lisse, mat | smooth, matt

434869

zementgrau | gris ciment | cement-grey
eben, matt | lisse, mat | smooth, matt

Art.	Nennmaß cote nominale nominal size cm	Herstellmaß cote de fabrication production size mm	m ²	Paket carton box	Palette palette pallet	Beanspr.-Gruppe groupe d'emploi wear resist. group	Norm Norme Standard	Trittsicherheit antidérapance non-slip	Preisgruppe groupe de prix price category
434850							Bla UGL	R10/B	W278 (m ²)
434851	5 x 5	47 x 47 x 10,5	11,111 Bögen plaques sheets	11 Bögen plaques sheets	29,700 m ²		Bla UGL	R10/B	W278 (m ²)
434852			22,222 kg	0,990 m ² 22,000 kg	660,000 kg		Bla UGL	R10/B	W278 (m ²)
434853							Bla UGL	R10/B	W278 (m ²)

Mosaik | Mosaique | Mosaic

Feinsteinzeugfliesen unglasiert | grès cérame fin vitrifié non-émaillés | porcelain stoneware tiles unglazed

5 x 5 cm



434850

V4

braun | brun | brown
eben, matt
lisse, mat
smooth, matt

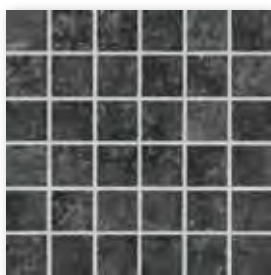

434851

V4

anthrazit | anthracite
eben, matt
lisse, mat
smooth, matt

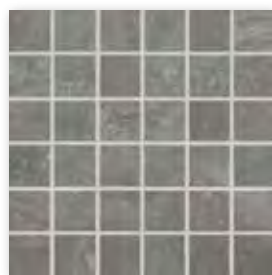

434852

V3

basalt | basalte | basalt
eben, matt
lisse, mat
smooth, matt

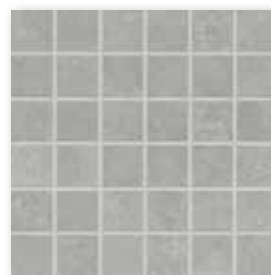

434853

V3

zementgrau | gris ciment | cement-grey
eben, matt
lisse, mat
smooth, matt



Mosaik, Verklebung rückseitig auf Glasfasernetz,
Bogen: 297 x 297 mm

Mosaique, collée sur trame en fibre de verre à
l'envers, Feuille : 297 x 297 mm

Mosaic, glass fibre net on reverse side,
Sheet: 297 x 297 mm



Studioaufnahme · photo prise en studio · studio photo / Architekt · architecte · architect: STELLWERK architekten, Dresden, Deutschland /
Serie · série · series: Soul / Photo: Jochen Stüber



3D-Rendering / Serie · série · series: Stories



Wenn Räume erzählen

Die Serie Stories kommt durch und durch urban daher: mit ihrer Optik von Zement, ihren zeitlosen Grautönen, ihren vielen kreativen Möglichkeiten und ihrer faszinierenden Großzügigkeit. Über die bewusste Kombination von Serienkomponenten spiegeln sich die individuellen Vorlieben der Bewohner wider: Der Raum erzählt Geschichten. Die Bodenfliesen überzeugen durch ihre soften Nuancierungen und ihre unverfälschte, steinmatte Charakteristik von Zement. Für ein reizvoll urbanes Flair. Spannend wird die Serie Stories durch ihre zwei Dekore: das Schnittdekor Tangram und das Volldekor Ivy.

Lorsque les pièces racontent une histoire

La Série Stories est urbaine de A à Z : avec son aspect ciment et ses tons gris intemporels, ses nombreuses possibilités en matière de création et une fascinante générosité. La combinaison des composants de cette série reflète les goûts de ses occupants : la pièce raconte alors une histoire. Ces carreaux de sol sauront convaincre par leurs nuances douces et la pureté minérale du ciment. Pour donner aux espaces un charme urbain. Deux passionnants nouveaux décors viennent compléter la Série Stories : le décor découpé Tangram et le décor intégral Ivy.

When rooms tell stories

The series Stories is urban to the core: with its cement-like look, timeless grey shades, countless creative options and fascinating opulence. The intentional combination of components of the series reflects the residents' individual preferences: rooms literally tell stories. The floor tiles are convincing thanks to their soft nuances and unadulterated, stone-matt cement characteristics, thus creating an appealingly urban flair. What also makes the series Stories interesting is its two decoration variants: the Tangram cut decor and the Ivy full decor.

Art.	Nennmaß cote nominale nominal size cm	Herstellmaß cote de fabrication production size mm	m ²	Paket carton box	Palette palette pallet	Beanspr.-Gruppe groupe d'emploi wear resist. group	Norm Norme Standard	Trittsicherheit antidérapance non-slip	Preisgruppe groupe de prix price category
283177H	30 x 60	297 x 597 x 9	5,556 St pc	9 St pc	77,754 m ²		BIII GL		W63 (m ²)
283178H			14,946 kg	1,620 m ² 24,210 kg	1.162,080 kg		BIII GL		W63 (m ²)
363352H	35 x 100	347 x 997 x 6	2,857 St pc	5 St pc	70,000 m ²		BIII GL		W124 (m ²)
363353H			10,513 kg	1,750 m ² 18,400 kg	736,000 kg		BIII GL		W124 (m ²)

Wandfliese | carreau de mur | wall tile

Steingut glasiert | faïence émaillée | earthenware glazed

30 x 60 cm



283177H

pearl

steinmatt, strukturiert | pierre mat, structuré | stone-matt, structured



283178H

soft grey

steinmatt, strukturiert | pierre mat, structuré | stone-matt, structured



35 x 100 cm



363352H

pearl

steinmatt, strukturiert | pierre mat, structuré | stone-matt, structured

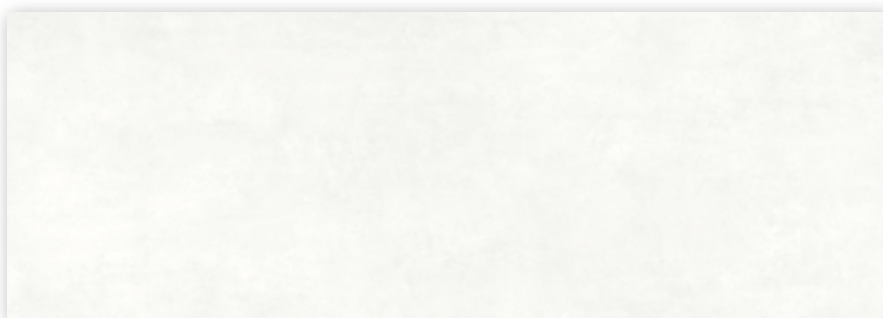
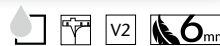

363353H

soft grey

steinmatt, strukturiert | pierre mat, structuré | stone-matt, structured



Art.	Nennmaß cote nominale nominal size cm	Herstellmaß cote de fabrication production size mm	m ²	Paket carton box	Palette palette pallet	Beanspr.-Gruppe groupe d'emploi wear resist. group	Norm Norme Standard	Trittsicherheit antidérapance non-slip	Preisgruppe groupe de prix price category
283187H	30 x 60	297 x 597 x 9	5,556 St pc	9 St pc	77,754 m ²		BIII GL		W91 (m ²)
283188H			14,946 kg	1,620 m ² 24,210 kg	1.162,080 kg		BIII GL		W91 (m ²)
363354H	35 x 100	347 x 997 x 6	2,857 St pc	5 St pc	70,000 m ²		BIII GL		W130 (m ²)
363355H			10,513 kg	1,750 m ² 18,400 kg	736,000 kg		BIII GL		W130 (m ²)

Dekorationselemente | éléments décoratifs | decoration elements

Volldekor Ivy | Volldekor carreau décoratif Ivy | decorative element Ivy

Steingut glasiert | faïence émaillée | earthenware glazed

30 x 60 cm



283187H
soft sepia
steinmatt, strukturiert | pierre mat, structuré | stone-matt, structured



283188H
soft concrete
steinmatt, strukturiert | pierre mat, structuré | stone-matt, structured



35 x 100 cm



363354H
soft sepia
steinmatt, strukturiert | pierre mat, structuré | stone-matt, structured

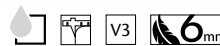

363355H
soft concrete
steinmatt, strukturiert | pierre mat, structuré | stone-matt, structured

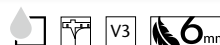

Abgabe der Dekorationselemente ausschließlich in vollen Kartons.
Eléments décoratifs uniquement livrables en cartons entiers.
Decoration elements only available in full boxes.

Art.	Nennmaß cote nominale nominal size cm	Herstellmaß cote de fabrication production size mm	m	Paket carton box	Palette palette pallet	Beanspr.-Gruppe groupe d'emploi wear resist. group	Norm Norme Standard	Trittsicherheit antidérapance non-slip	Preisgruppe groupe de prix price category
283179H							Bla UGL	R10/A	W501 (St pc)
283180H	30 x 30	297 x 297 x 10,5	3,333 Bögen plaques sheets	2 Bögen plaques sheets			Bla UGL	R10/A	W501 (St pc)
283181H			6,613 kg	0,600 m	3,968 kg		Bla UGL	R10/A	W501 (St pc)
283182H							Bla UGL	R10/A	W501 (St pc)
363356 <small>NEW</small>							Bla UGL	R10/A	W501 (St pc)
363357 <small>NEW</small>	30 x 30	297 x 297 x 6	3,333 Bögen plaques sheets	3 Bögen plaques sheets			Bla UGL	R10/A	W501 (St pc)
363358 <small>NEW</small>			3,776 kg	0,900 m	3,399 kg		Bla UGL	R10/A	W501 (St pc)
363359 <small>NEW</small>							Bla UGL	R10/A	W501 (St pc)

Dekorationselemente | éléments décoratifs | decoration elements

Mosaikmatte Tangram | mosaïque Tangram | mosaic sheet Tangram

Feinsteinzeugfliesen unglasiert | grès cérame fin vitrifié non-émaillés | porcelain stoneware tiles unglazed

30 x 30 cm



283179H

ivory
strukturiert, matt
structuré, mat
structured, matt



283180H

concrete
strukturiert, matt
structuré, mat
structured, matt



283181H

sepia
strukturiert, matt
structuré, mat
structured, matt

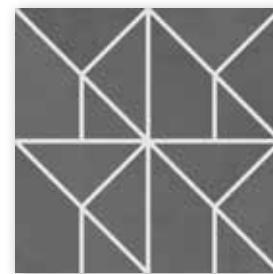

283182H

anthracite
strukturiert, matt
structuré, mat
structured, matt



363356

ivory
strukturiert, matt
structuré, mat
structured, matt

363357

concrete
strukturiert, matt
structuré, mat
structured, matt

363358

sepia
strukturiert, matt
structuré, mat
structured, matt

363359

anthracite
strukturiert, matt
structuré, mat
structured, matt



Mosaik, Verklebung rückseitig auf Glasfasernetz,
Bogen: 297 x 297 mm

Mosaïque, collée sur trame en fibre de verre à
l'envers, Feuille : 297 x 297 mm

Mosaic, glass fibre net on reverse side,
Sheet: 297 x 297 mm

Abgabe der Dekorationselemente ausschließlich in vollen Kartons.
Éléments décoratifs uniquement livrables en cartons entiers.
Decoration elements only available in full boxes.

Art.	Nennmaß cote nominale nominal size cm	Herstellmaß cote de fabrication production size mm	m ²	Paket carton box	Palette palette pallet	Beanspr.-Gruppe groupe d'emploi wear resist. group	Norm Norme Standard	Trittsicherheit antidérapance non-slip	Preisgruppe groupe de prix price category
432315H							Bla UGL	R10/A	W72 (m ²)
432316H	30 x 60	297 x 597 x 10,5	5,556 St pc	6 St pc	43,197 m ²		Bla UGL	R10/A	W72 (m ²)
432317H			23,224 kg	1,080 m ² 25,080 kg	1.003,200 kg		Bla UGL	R10/A	W72 (m ²)
432318H							Bla UGL	R10/A	W72 (m ²)
432319H							Bla UGL	R10/A	W84 (m ²)
432320H	60 x 60	597 x 597 x 10,5	2,778 St pc	3 St pc	38,877 m ²		Bla UGL	R10/A	W84 (m ²)
432321H			23,769 kg	1,080 m ² 25,668 kg	924,048 kg		Bla UGL	R10/A	W84 (m ²)
432322H							Bla UGL	R10/A	W84 (m ²)



ivory



concrete



sepia



anthracite



Bodenfliese | carreau de sol | floor tile

Feinsteinzeugfliesen unglasiert | grès cérame fin vitrifié non-émailés | porcelain stoneware tiles unglazed

30 x 60 cm



432315H
ivory
strukturiert, matt
structuré, mat
structured, matt

432316H
concrete
strukturiert, matt
structuré, mat
structured, matt

432317H
sepia
strukturiert, matt
structuré, mat
structured, matt

432318H
anthracite
strukturiert, matt
structuré, mat
structured, matt

60 x 60 cm

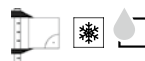

432319H
ivory
strukturiert, matt
structuré, mat
structured, matt

432320H
concrete
strukturiert, matt
structuré, mat
structured, matt

432321H
sepia
strukturiert, matt
structuré, mat
structured, matt

432322H
anthracite
strukturiert, matt
structuré, mat
structured, matt

Art.	Nennmaß cote nominale nominal size cm	Herstellmaß cote de fabrication production size mm	m ²	Paket carton box	Palette palette pallet	Beanspr.-Gruppe groupe d'emploi wear resist. group	Norm Norme Standard	Trittsicherheit antidérapance non-slip	Preisgruppe groupe de prix price category
432323							Bla UGL	R10/A	W140 (m ²)
432324	100 x 100	997 x 997 x 6	1,000 St pc	2 St pc	50,000 m ²		Bla UGL	R10/A	W140 (m ²)
432325			14,100 kg	2,000 m ² 28,200 kg	705,000 kg		Bla UGL	R10/A	W140 (m ²)
432326							Bla UGL	R10/A	W140 (m ²)



ivory



concrete



sepia



anthracite



Bodenfliese | carreau de sol | floor tile

Feinsteinzeugfliesen unglasiert | grès cérame fin vitrifié non-émaillés | porcelain stoneware tiles unglazed

100 x 100 cm



432323

ivory
strukturiert, matt
structuré, mat
structured, matt

432324

concrete
strukturiert, matt
structuré, mat
structured, matt

432325

sepia
strukturiert, matt
structuré, mat
structured, matt

432326

anthracite
strukturiert, matt
structuré, mat
structured, matt

Achtung: Sonderpalette. Keine Rücknahme, kein Umtausch.
Attention : palette spéciale. Pas de retour, pas d'échange.
Please note: special pallet. No return, no exchange.

Art.	Nennmaß cote nominale nominal size cm	Herstellmaß cote de fabrication production size mm	m	Paket carton box	Palette palette pallet	Beanspr.-Gruppe groupe d'emploi wear resist. group	Norm Norme Standard	Trittsicherheit antidérapance non-slip	Preisgruppe groupe de prix price category
432331H							Bla UGL	R10/A	W473 (St pc)
432332H	30 x 60	297 x 597 x 10,5	1,667 St pc	6 St pc			Bla UGL	R10/A	W473 (St pc)
432333H			6,968 kg	3,599 m	25,080 kg		Bla UGL	R10/A	W473 (St pc)
432334H							Bla UGL	R10/A	W473 (St pc)
432327H							Bla UGL		W439 (St pc)
432328H	7 x 60	70 x 597 x 10,5	1,667 St pc	15 St pc			Bla UGL		W439 (St pc)
432329H			1,584 kg	8,998 m	14,250 kg		Bla UGL		W439 (St pc)
432330H							Bla UGL		W439 (St pc)

Treppenfliese | nez de marche | stair tile

Feinsteinzeugfliesen unglasiert | grès cérame fin vitrifié non-émaillés | porcelain stoneware tiles unglazed

30 x 60 cm



432331H

ivory
strukturiert, matt
structuré, mat
structured, matt

432333H

sepia
strukturiert, matt
structuré, mat
structured, matt

432332H

concrete
strukturiert, matt
structuré, mat
structured, matt

432334H

anthracite
strukturiert, matt
structuré, mat
structured, matt

Auftragsfertigung: Rückgabe und/oder Stornierung bestellter Ware nicht möglich.

Fabrication sur commande : il nous est impossible d'accepter l'annulation de commandes d'articles ou le retour d'articles.

Make-to-order production: return and/or cancellation of ordered products not possible.

Sockel, gerundet | plinthe, arrondie | skirting, rounded

Feinsteinzeugfliesen unglasiert | grès cérame fin vitrifié non-émaillés | porcelain stoneware tiles unglazed

7 x 60 cm

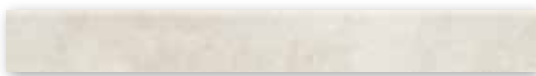

432327H

ivory
strukturiert, matt
structuré, mat
structured, matt

432329H

sepia
strukturiert, matt
structuré, mat
structured, matt

432328H

concrete
strukturiert, matt
structuré, mat
structured, matt

432330H

anthracite
strukturiert, matt
structuré, mat
structured, matt

Art.	Nennmaß cote nominale nominal size cm	Herstellmaß cote de fabrication production size mm	m ²	Paket carton box	Palette palette pallet	Beanspr.-Gruppe groupe d'emploi wear resist. group	Norm Norme Standard	Trittsicherheit antidérapance non-slip	Preisgruppe groupe de prix price category
432335H							Bla UGL	R10/B	W151 (m ²)
432336H	5 x 5	47 x 47 x 6,5	11 Bögen plaques sheets	11 Bögen plaques sheets	64,000 m ²		Bla UGL	R10/B	W151 (m ²)
432337H			12,331 kg	1,000 m ² 12,331 kg	789,184 kg		Bla UGL	R10/B	W151 (m ²)
432338H							Bla UGL	R10/B	W151 (m ²)
434986H							Bla UGL	R11/B	W151 (m ²)
434987H	60 x 60	597 x 597 x 20	2,778 St pc	2 St pc	21,598 m ²		Bla UGL	R11/B	W151 (m ²)
434988H			45,273 kg	0,720 m ² 32,500 kg	977,820 kg		Bla UGL	R11/B	W151 (m ²)
434989H							Bla UGL	R11/B	W151 (m ²)

Mosaik | mosaïque | mosaic

Feinsteinzeugfliesen unglasiert | grès cérame fin vitrifié non-émaillés | porcelain stoneware tiles unglazed

5 x 5 cm



432335H

ivory
strukturiert, matt | structuré, mat |
structured, matt



432336H

concrete
strukturiert, matt | structuré, mat |
structured, matt

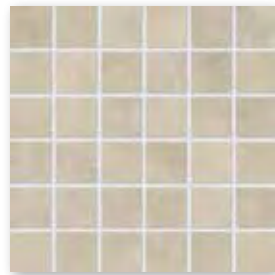

432337H

sepia
strukturiert, matt | structuré, mat |
structured, matt

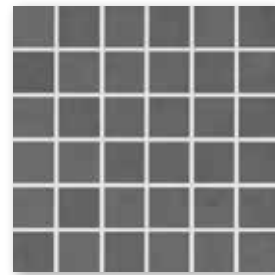

432338H

anthracite
strukturiert, matt | structuré, mat |
structured, matt



Mosaik, rückseitig thermoplastisch verklebt
Bogen: 297 x 297 mm

Mosaïque, collage thermoplastique sur l'envers
Feuille: 297 x 297 mm

Mosaic, glued thermo-plastically on back
Sheet: 297 x 297 mm

Terrassenplatte | dalle de terrasse | patio tile*

Feinsteinzeugfliesen unglasiert | grès cérame fin vitrifié non-émaillés | porcelain stoneware tiles unglazed

60 x 60 cm



434986H

ivory
strukturiert, matt
structuré, mat
structured, matt

434987H

concrete
strukturiert, matt
structuré, mat
structured, matt

434988H

sepia
strukturiert, matt
structuré, mat
structured, mat

434989H

anthracite
strukturiert, matt
structuré, mat
structured, mat

* Hohes Gewicht! Karton bitte nur zu Zweit transportieren.
* Poids élevé ; a transporter par deux personnes seulement.
* High weight only to carry with two persons.



Lässig und modern

Bei Timeless verschmelzen Grafik und Relief von vertrautem Schiefer zu einer modernen Oberfläche, die Zeitlosigkeit, Eleganz und Coolness transportiert. So passt sich die Serie in verschiedene Stilwelten harmonisch ein: von lässig, modern bis gemütlich. Highlight der Serie ist die reliefierte Dekorfliese Arita, entwickelt in der Zusammenarbeit mit dem Designer Fritz Rossmann. In Anlehnung an seine bekannten Porzellan-gefäße verführt Arita durch ihre wechselnd rhythmischen Kerbungen zum Berühren und Fühlen – und Zeitlosigkeit trifft haptische Erfahrung.

Pour un style casual, moderne ou maison de campagne

La série Timeless utilise les reliefs de l'ardoise classique pour créer une surface moderne, qui véhicule un caractère intemporel, élégant et cool. La série convient ainsi idéalement à différents univers, qu'ils soient chaleureux, modernes ou plutôt décontractés. La pièce maîtresse de la série est le carreau de décoration à relief Arita, développé en collaboration avec le designer Fritz Rossmann. Arita s'inspire des célèbres céramiques japonaises. Le rythme de ces rainures changeantes invite au toucher. La rencontre d'un style intemporel et d'une expérience tactile unique.

For casual, modern or country living

The look and feel of familiar slate in the Timeless range merge to form a modern surface which exudes timelessness, elegance and coolness. Enabling the range to adapt harmoniously to various style collections: whether casual, modern or cosy. One highlight of the range is represented by the structured Arita decorative element, developed in collaboration with the designer Fritz Rossmann. In conformity with his popular porcelain bowls, Arita entices you to touch and feel its changing rhythmic notching – where timelessness meets a haptic experience.





3D-Rendering / Serie · série · series: Timeless

Art.	Nennmaß cote nominale nominal size cm	Herstellmaß cote de fabrication production size mm	m ²	Paket carton box	Palette palette pallet	Beanspr.-Gruppe groupe d'emploi wear resist. group	Norm Norme Standard	Trittsicherheit antidérapance non-slip	Preisgruppe groupe de prix price category
283172H	30 x 60	297 x 597 x 9	5,556 St pc	9 St pc	77,754 m ²		BIII GL		B65 (m²)
283173H			14,946 kg	1,620 m ² 24,210 kg	1.162,080 kg		BIII GL		B82 (m²)

Wandfliese | carreau de mur | wall tile

Steingut glasiert | faïence émaillée | earthenware glazed

30 x 60 cm

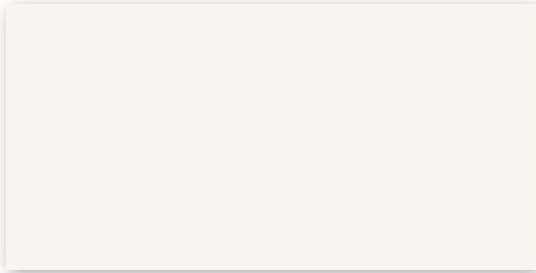

283172H

natural white
steinmatt, strukturiert | pierre mat, structuré | stone-matt, structured

Dekorationselemente | éléments décoratifs | decoration elements

Dekorfliese Arita | carreau décoratif Arita | decorative element Arita

Steingut glasiert | faïence émaillée | earthenware glazed

30 x 60 cm



283173H

natural white
steinmatt, strukturiert | pierre mat, structuré | stone-matt, structured

Abgabe der Dekorationselemente ausschließlich in vollen Kartons.
Éléments décoratifs uniquement livrables en cartons entiers.
Decoration elements only available in full boxes.

Art.	Nennmaß cote nominale nominal size cm	Herstellmaß cote de fabrication production size mm	m	Paket carton box	Palette palette pallet	Beanspr.-Gruppe groupe d'emploi wear resist. group	Norm Norme Standard	Trittsicherheit antidérapance non-slip	Preisgruppe groupe de prix price category
283174H							Bla UGL	R10/B	B510 (St pc)
283175H	30 x 30	297 x 297 x 10,5	3,333 St pc	2 St pc			Bla UGL	R10/B	B510 (St pc)
283176H			6,933 kg	0,600 m	4,160 kg		Bla UGL	R10/B	B510 (St pc)

Dekorationselemente | éléments décoratifs | decoration elements

Mosaikmatte Trio | mosaïque Trio | mosaic sheet Trio

Feinsteinzeugfliesen unglasiert | grès cérame fin vitrifié non-émaillés | porcelain stoneware tiles unglazed

30 x 30 cm



283174H

sand
strukturiert, matt
structuré, mat
structured, matt



283175H

pebble grey
strukturiert, matt
structuré, mat
structured, matt



283176H

black
strukturiert, matt
structuré, mat
structured, matt



Mosaik, Verklebung
rückseitig auf
Glasfasernetz, Bogen:
297 x 297 mm

Mosaïque, collée sur
trame en fibre de verre à
l'envers, Feuille :
297 x 297 mm

Mosaic, glass fibre net
on reverse side, Sheet:
297 x 297 mm

Abgabe der Dekorationselemente ausschließlich in vollen Kartons.
Éléments décoratifs uniquement livrables en cartons entiers.
Decoration elements only available in full boxes.

Art.	Nennmaß cote nominale nominal size cm	Herstellmaß cote de fabrication production size mm	m ²	Paket carton box	Palette palette pallet	Beanspr.-Gruppe groupe d'emploi wear resist. group	Norme Norme Standard	Trittsicherheit antidérapance non-slip	Preisgruppe groupe de prix price category
432086H							Bla UGL	R10/B	B112 (m ²)
432087H	30 x 60	297 x 597 x 10,5	5,556 St pc	6 St pc	43,197 m ²		Bla UGL	R10/B	B112 (m ²)
432088H			23,224 kg	1,080 m ² 25,080 kg	1.003,200 kg		Bla UGL	R10/B	B112 (m ²)
432089H							Bla UGL	R10/B	B126 (m ²)
432090H	60 x 60	597 x 597 x 10,5	2,778 St pc	3 St pc	38,877 m ²		Bla UGL	R10/B	B126 (m ²)
432091H			23,769 kg	1,080 m ² 25,668 kg	924,048 kg		Bla UGL	R10/B	B126 (m ²)



sand



pebble grey

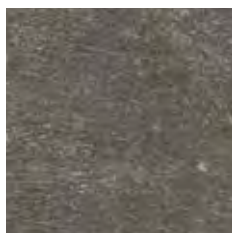

black



Bodenfliese | carreau de sol | floor tile

Feinsteinzeugfliesen unglasiert | grès cérame fin vitrifié non-émaillés | porcelain stoneware tiles unglazed

30 x 60 cm



432086H

sand
strukturiert, matt
structuré, mat
structured, matt



432087H

pebble grey
strukturiert, matt
structuré, mat
structured, matt

432088H

black
strukturiert, matt
structuré, mat
structured, matt

60 x 60 cm



432089H

sand
strukturiert, matt
structuré, mat
structured, matt



432090H

pebble grey
strukturiert, matt
structuré, mat
structured, matt

432091H

black
strukturiert, matt
structuré, mat
structured, matt

Art.	Nennmaß cote nominale nominal size cm	Herstellmaß cote de fabrication production size mm	m ² /m	Paket carton box	Palette palette pallet	Beanspr.-Gruppe groupe d'emploi wear resist. group	Norm Norme Standard	Trittsicherheit antidérapance non-slip	Preisgruppe groupe de prix price category
432092H							Alb UGL	R10/B	B152 (m ²)
432093H	60 x 120	597 x 1197 x 10,5	1,388 St pc / m ²	2 St pc	30,259 m ²		Alb UGL	R10/B	B152 (m ²)
432094H			23,804 kg	1,441 m ²	34,300 kg		Alb UGL	R10/B	B152 (m ²)
432095H							Bla UGL		B440 (St pc)
432096H	7 x 60	70 x 597 x 10,5	1,667 St pc / m	15 St pc			Bla UGL		B440 (St pc)
432097H			1,584 kg	8,998 m	14,250 kg		Bla UGL		B440 (St pc)

Bodenfliese | carreau de sol | floor tile

Feinsteinzeugfliesen unglasiert | grès cérame fin vitrifié non-émaillés | porcelain stoneware tiles unglazed

60 x 120 cm



432092H

sand
strukturiert, matt
structuré, mat
structured, matt

432093H

pebble grey
strukturiert, matt
structuré, mat
structured, matt

432094H

black
strukturiert, matt
structuré, mat
structured, matt

Sockel, gerundet | plinthe, arrondie | skirting, rounded

Feinsteinzeugfliesen unglasiert | grès cérame fin vitrifié non-émaillés | porcelain stoneware tiles unglazed

7 x 60 cm

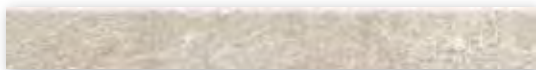

432095H

sand
strukturiert, matt
structuré, mat
structured, matt

432096H

pebble grey
strukturiert, matt
structuré, mat
structured, matt

432097H

black
strukturiert, matt
structuré, mat
structured, matt



Studioaufnahme · photo prise en studio · studio photo / Serie · série · series: Trevi / Photo: Herbert Bürger



Klassisch und schlicht

Die Serie Trevi setzt keramisch das Naturmaterial Marmor um. Zu den Wandfliesen in zwei Farbstellungen, Weiß-Grau und Weiß-Beige kann das dynamische, kontrastreiche Schnittdekor aus Feinsteinzeug kombiniert werden.

Classique et simple

La série Trevi est une interprétation céramique du matériau naturel qu'est le marbre. Le décor découpé, dynamique et contrasté, en grès cérame fin vitrifié peut être combiné avec les carreaux de mur en deux coloris, à savoir blanc-gris et blanc-beige.

Classic and simple

The Trevi series ceramically interprets marble as a natural material. The wall tiles in the two colours white-grey and white-beige can be combined with the dynamic, high-contrast cut decor made of porcelain stoneware.

Art.	Nennmaß cote nominale nominal size cm	Herstellmaß cote de fabrication production size mm	m ² /m	Paket carton box	Palette palette pallet	Beanspr.-Gruppe groupe d'emploi wear resist. group	Norm Norme Standard	Trittsicherheit antidérapance non-slip	Preisgruppe groupe de prix price category
280867							BIII GL	B69 (m ²)	
280868	30 x 60	296 x 595 x 9	5,556 St pc / m ²	9 St pc	77,754 m ²		BIII GL	B69 (m ²)	
280869			14,946 kg	1,620 m ² 24,210 kg	1.162,080 kg		BIII GL	B69 (m ²)	
280870							BIII GL	B69 (m ²)	
280786	4,7 x 30	47 x 296 x 10,5	3,333 St pc / m	6 St pc			Bla UGL	B447 (St pc)	
280787			0,967 kg	1,800 m 1,740 kg			Bla UGL	B447 (St pc)	

Wandfliese | carreau de mur | wall tile

Steingutfliessen glasiert | faïence émaillé | earthenware tiles glazed

30 x 60 cm

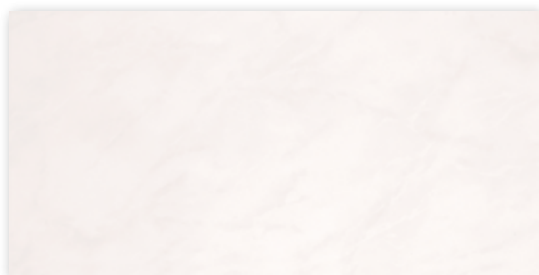

V2



V2

280867

weiß-grau | blanc-gris | white-grey
glänzend, eben | brillant, lisse | glossy, smooth

280868

weiß-beige | blanc-beige | white-beige
glänzend, eben | brillant, lisse | glossy, smooth

280869

weiß-grau | blanc-gris | white-grey
seidenmatt, eben | satinée, lisse | silky-matt, smooth

280870

weiß-beige | blanc-beige | white-beige
seidenmatt, eben | satinée, lisse | silky-matt, smooth

Dekorationselemente | éléments décoratifs | decoration elements

Bordüre | bordure | border

Feinsteinzeugfliesen unglasiert | grès cérame fin vitrifié non-émaillés | porcelain stoneware tiles unglazed

4,7 x 30 cm

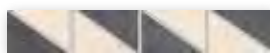
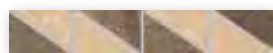

280786

beige-braun | beige-brun | beige-brown
strukturiert, matt | structuré, mat | structured, matt

280787

beige-anthrazit | beige anthracite | beige-anthracite
strukturiert, matt | structuré, mat | structured, matt

Abgabe der Dekorationselemente ausschließlich in vollen Kartons.
Éléments décoratifs uniquement livrables en cartons entiers.
Decoration elements only available in full boxes.



Studioaufnahme · photo prise en studio · studio photo / Serie · série · series: Trevi / Photo: Herbert Bürger



Studioaufnahme · photo prise en studio · studio photo / Architekt · architecte · architect: VSBL, Belgrad, Serbien · Belgrade, Serbie · Belgrade, Serbia /
Serie · série · series: Urban Cotto / Photo: Jochen Stüber



Natürlichkeit trifft City

Urban Cotto bringt natürliche Eleganz in den gesamten Wohnbereich. Die Protecta-vergütete Feinsteinzeugserie überzeugt durch ihr klares Konzept: ein Format in 60 x 60 cm, in klassischem Terra, Beige, Braun oder Grau und mit Trittsicherheitsstufe R10. Für eine kompromisslose Gestaltung nach dem Vorbild traditionsreicher Cotto-Fliesen.

Le naturel à la rencontre de l'urbain

Urban Cotto apporte aux espaces intérieurs, grâce aux variantes conçues à cet effet, une touche d'élégance naturelle. La gamme, des carreaux en grés cérame à revêtement Protecta, séduit par la clarté de son concept : un format de 60 x 60 cm pour des carreaux antidérapants R10 aux teintes classique terra, beige, brun et gris. Pour une décoration sans compromis sur le modèle des carreaux en terre cuite, riches en tradition.

Naturalness meets the city

Urban Cotto injects natural elegance into the entire living area. The Protecta-coated porcelain stoneware series is convincing thanks to its unambiguous concept: one format in 60 x 60 cm, in classic terra, beige, brown or grey and with non-slip R10. For an uncompromising design based on traditional cotto tiles.

URBAN COTTO

Art.	Nennmaß cote nominale nominal size cm	Herstellmaß cote de fabrication production size mm	m ²	Paket carton box	Palette palette pallet	Beanspr.-Gruppe groupe d'emploi wear resist. group	Norm Norme Standard	Trittsicherheit antidérapance non-slip	Preisgruppe groupe de prix price category
052292							Bla UGL	R10	W130 (m ²)
052293	60 x 60	596 x 596 x 10	2,778 St pc	3 St pc	43,197 m ²		Bla UGL	R10	W130 (m ²)
052294			22,780 kg	1,080 m ² 24,600 kg	984,000 kg		Bla UGL	R10	W130 (m ²)
052295							Bla UGL	R10	W130 (m ²)



beige

V3

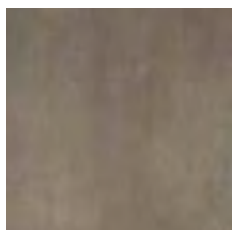

braun
brun
brown

V3

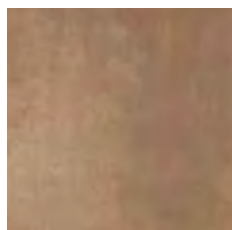

terra

V3



grau
gris
grey

V3

Bodenfliese | carreau de sol | floor tile

Feinsteinzeugfliesen unglasiert | grès cérame fin vitrifié non-émaillés | porcelain stoneware tiles unglazed

60 x 60 cm



052292

beige
eben, matt | lisse, mat | smooth, matt

052293

braun | brun | brown
eben, matt | lisse, mat | smooth, matt

052294

terra
eben, matt | lisse, mat | smooth, matt

052295

grau | gris | grey
eben, matt | lisse, mat | smooth, matt

Art.	Nennmaß cote nominale nominal size cm	Herstellmaß cote de fabrication production size mm	m	Paket carton box	Palette palette pallet	Beanspr.-Gruppe groupe d'emploi wear resist. group	Norm Norme Standard	Trittsicherheit antidérapance non-slip	Preisgruppe groupe de prix price category
052401							Bla UGL	W439 (St pc)	
052402	7 x 60	70 x 596 x 10	1,667 St pc	22 St pc			Bla UGL	W439 (St pc)	
052403			1,550 kg	13,197 m	20,460 kg		Bla UGL	W439 (St pc)	
052404							Bla UGL	W439 (St pc)	

Sockel, gerundet | plinthe, arrondie | skirting, rounded

Feinsteinzeugfliesen unglasiert | grès cérame fin vitrifié non-émaillés | porcelain stoneware tiles unglazed

7 x 60 cm

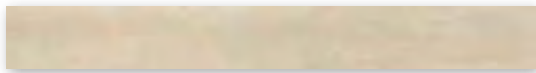

052401

beige
eben, matt | lisse, mat | smooth, matt

052402

braun | marron | brown
eben, matt | lisse, mat | smooth, matt

052403

terra
eben, matt | lisse, mat | smooth, matt

052404

grau | gris | grey
eben, matt | lisse, mat | smooth, matt



3D-Rendering / Serie · série · series: Walden



Kraftvoll, entspannt und zeitlos

Walden ist ein klassisches, naturgetreues Holzdesign gefertigt in hochwertiger Keramik. Ein natürliches Produkt, das die Beliebtheit von authentischen Holzoberflächen mit den Vorteilen keramischer Belagsmaterialien verbindet. Die 5 Farbtöne im klassischen Dielenformat 20 x 120 cm bedienen ein weites Spektrum unterschiedlichster Stilrichtungen und lassen sich je nach Wunsch harmonisch oder kontrastreich mit anderen Materialien kombinieren. Für den Outdoor Bereich stehen alle Farben im Format 40 x 120 cm zur Verfügung. Die Trittsicherheit R10/A+B sorgt für vielseitige Anwendungsmöglichkeiten im privaten und öffentlichen Interieur. Im Außenbereich bietet die Oberflächen R11/B bei jedem Wetter ein sicheres Trittgefühl.

Puissant, détendu et hors temps

Walden est un design de bois classique, réaliste, fabriqué en céramique de haute qualité. Un produit naturel qui combine la popularité des surfaces en bois authentique avec les avantages des matériaux de revêtement en céramique. Les 5 nuances de couleurs du format classique de planche de 20 x 120 cm couvrent un large éventail de styles différents et peuvent être combinées de façon harmonieuse ou contrastante avec d'autres matériaux selon les besoins. Pour la zone extérieure, toutes les couleurs sont disponibles au format de 40 x 120 cm. L'antidérapance R10/A+B assure des possibilités d'application variées dans les intérieurs privés et publics. À l'extérieur, la surface R11/B permet de marcher en toute sécurité, quelles que soient les conditions météorologiques.

Powerful, relaxed and timeless

Walden is a classic, natural wood design manufactured in high quality ceramic. It is a natural product that combines the popularity of wood surfaces with the advantages of ceramic flooring materials. The 5 color shades in the classic 20 x 120 cm plank format serve a wide range of different styles and can be combined harmoniously or in contrast with other materials as desired. For the outdoor area are all colors in the format 40 x 120 cm available. The slip resistance R10/A+B provides for versatile application possibilities in private and public interiors. For outdoor use, the R11/B surface offers a safe feeling of safe step feeling.

Art.	Nennmaß cote nominale nominal size cm	Herstellmaß cote de fabrication production size mm	m ² /m	Paket carton box	Palette palette pallet	Beanspr.-Gruppe groupe d'emploi wear resist. group	Norm Norme Standard	Trittsicherheit antidérapance non-slip	Preisgruppe groupe de prix price category
430685							Bla UGL	R10/A+B	B126 (m ²)
430686							Bla UGL	R10/A+B	B126 (m ²)
430687	20 x 120	197 x 1195 x 9	4,166 St pc	6 St pc	60,490 m ²		Bla UGL	R10/A+B	B126 (m ²)
430688			20,830 kg	1,440 m ² 30,000 kg	1.260,00 kg		Bla UGL	R10/A+B	B126 (m ²)
430689							Bla UGL	R10/A+B	B126 (m ²)
430690							Bla UGL		B437 (St pc)
430691							Bla UGL		B437 (St pc)
430692	6 x 60	60 x 596 x 9	1,667 St pc	27 St pc			Bla UGL		B437 (St pc)
430693			1,237 kg	16,797 m 20,034 kg			Bla UGL		B437 (St pc)
430694							Bla UGL		B437 (St pc)



sunny white



relax beige

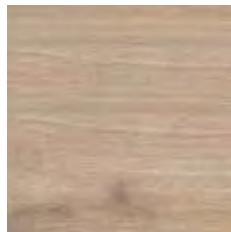

classic oak

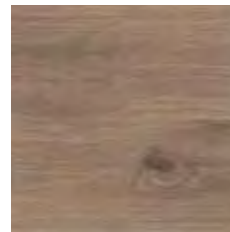

brown cherry



smokey brown



Bodenfliese | carreau de sol | floor tile*

Feinsteinzeugfliesen unglasiert | grès fin non-émaillés | porcelain stoneware tiles unglazed

20 x 120 cm



430685

sunny white
strukturiert, matt
structuré, mat
structured, matt

430686

relax beige
strukturiert, matt
structuré, mat
structured, matt

430687

classic oak
strukturiert, matt
structuré, mat
structured, matt

430688

brown cherry
strukturiert, matt
structuré, mat
structured, matt

430689

smokey brown
strukturiert, matt
structuré, mat
structured, matt

Sockel, gerundet | plinthe, arrondie | skirting, rounded

Feinsteinzeugfliesen unglasiert | grès cérame fin vitrifié non-émaillés | porcelain stoneware tiles unglazed

6 x 60 cm

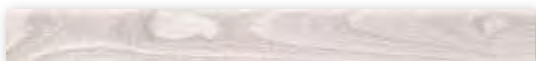

430690

sunny white
strukturiert, matt
structuré, mat
structured, matt

430691

relax beige
strukturiert, matt
structuré, mat
structured, matt

430692

classic oak
strukturiert, matt
structuré, mat
structured, matt

430693

brown cherry
strukturiert, matt
structuré, mat
structured, matt

430694

smokey brown
strukturiert, matt
structuré, mat
structured, matt

* Achtung: Sonderpalette. Keine Rücknahme, kein Umtausch.

* Attention : palette spéciale. Pas de retour, pas d'échange.

* Please note: special pallet. No return, no exchange.

Art.	Nennmaß cote nominale nominal size cm	Herstellmaß cote de fabrication production size mm	m ²	Paket carton box	Palette palette pallet	Beanspr.-Gruppe groupe d'emploi wear resist. group	Norm Norme Standard	Trittsicherheit antidérapance non-slip	Preisgruppe groupe de prix price category
430695							Bla UGL	R11/B	B182 (m ²)
430696							Bla UGL	R11/B	B182 (m ²)
430697	40 x 120	397 x 1195 x 20	2,083 St pc	2 St pc	23,047 m ²		Bla UGL	R11/B	B182 (m ²)
430698			43,535 kg	0,960 m ² 41,800 kg	1.260,00 kg		Bla UGL	R11/B	B182 (m ²)
430699							Bla UGL	R11/B	B182 (m ²)

Terrassenplatte | dalle de terrasse | patio tile*/**

Feinsteinzeugfliesen unglasiert | grès cérame fin vitrifié non-émaillés | porcelain stoneware tiles unglazed

40 x 120 cm



430695

sunny white
strukturiert, matt
structuré, mat
structured, matt

430696

relax beige
strukturiert, matt
structuré, mat
structured, matt

430697

classic oak
strukturiert, matt
structuré, mat
structured, matt

430698

brown cherry
strukturiert, matt
structuré, mat
structured, matt

430699

smokey brown
strukturiert, matt
structuré, mat
structured, matt

* Achtung: Sonderpalette. Keine Rücknahme, kein Umtausch.
* Attention : palette spéciale. Pas de retour, pas d'échange.
* Please note: special pallet. No return, no exchange.

** Hohes Gewicht! Karton bitte nur zu Zweit transportieren.
** Poids élevé ; a transporter par deux personnes seulement.
** High weight only to carry with two persons.

Artikelnummernübersicht · Aperçu des numéros d'articles · Article overview

Art.	Seite page	Art.	Seite page	Art.	Seite page	Art.	Seite page	Art.	Seite page
0002	104	231032	42	282820H	119	323230H	33	392739H	76
050439	179	231034	42	282823H	119	323260	44	392740H	76
052292	224	23330H	99	282824	121	323261	44	392742H	76
052293	224	239995	42	282826	121	323332H	99	392904H	168
052294	224	239996	42	282901	140	3251H	98	392905H	168
052295	224	239997	42	282902	140	3252H	98	392906H	169
052401	225	239998	42	282903	140	3258H	98	392907	170
052402	225	269478	42	283005	134	3303H	96	392908	170
052403	225	269479	42	283007	135	3304H	96	392909	170
052404	225	280345	60	283008	135	3305H	96	392910	170
059703	178	280349-73	60	283047H	152	3306	96	392911H	184
059741	179	280350-73	62	283048H	153	3314H	97	392912H	184
059800	178	280351-73	61	283049H	153	3353H	98	392913H	184
059801	178	280354	60	283059H	22	3354H	98	392914H	184
059805	178	280360	60	283060H	22	3500H	103	392915H	185
059811	179	280361	62	283062	23	3501H	103	392916H	185
059812	179	280362	61	283063	23	3503H	103	392917H	185
059813	179	280374	43	283064	23	3506H	103	392918	185
059814	179	280375	43	283065	23	3507H	103	392919	185
059815	179	280718	43	283066	23	3508H	103	393006	134
059816	179	280719	43	283073H	120	3509H	103	393050H	152
111052	40	280786	220	283074H	120	353022	44	393051H	153
112000	40	280787	220	283075H	120	353023	44	393052H	153
113063	40	280867	220	283076H	120	353183H	204	393067H	22
115100	40	280868	220	283102HR	66	353184H	204	393068H	22
173339	40	280869	220	283103HR	67	353185H	205	393104H	66
173340	40	280870	220	283106H	110	353186H	205	393105H	68
173368	40	280871	43	283107H	110	3540H	102	393115H	155
173369	40	280872	43	283110H	112	3541H	102	393116H	155
182105H	118	280874H	74	283111H	112	3546H	102	393127H	66
182106H	118	281140H	74	283112H	112	3547H	102	42000H	85
182125	121	281476	164	283113H	154	3548H	102	42001H	85
182126	121	281477	164	283114H	154	3549H	102	42002H	85
182127	121	281479	164	283126HR	66	363335	44	42010H	85
182763	41	281480	164	283172H	214	363336	44	42020H	85
182764	41	281726	48	283173H	214	363347H	146	42100H	88
182818H	118	281727	48	283174H	215	363348H	146	42101H	88
182821H	118	281728	49	283175H	215	363349H	147	42102H	88
182825	121	281729	49	283176H	215	363350H	148	42103H	88
182827	121	281730	49	283177H	204	363351H	146	42120H	86
183343	41	281731	49	283178H	204	363360H	110	42121H	86
183344	41	281732	49	283179H	206	363361H	110	42130H	87
203225H	32	281733	49	283180H	206	381474	41	42400H	84
203226H	32	282115R-02	43	283181H	206	381475	41	42401H	84
203229H	33	282116R-02	43	283182H	206	382819H	118	42402H	84
203264	43	282730H	74	283187H	205	382822H	118	42500H	84
203265	43	282731	75	283188H	205	391589	44	42501H	84
203331H	99	282733	75	283345	43	391590	44	430635	128
203333H	33	282734	75	283346	43	392720	48	430636	128
213341	40	282743H	56	3201H	97	392721	48	430637	128
213342	40	282745H	56	3202H	97	392723	50	430638	128
221379	180	282746	57	3203H	97	392724	50	430639	128
221380	180	282748	57	3206H	97	392725	50	430640	127
221381	180	282749H	56	3221H	96	392726	50	430641	127
229480	43	282751H	56	3222H	96	392727	50	430642	127
229481	43	282813H	119	3227	96	392728	50	430643	127
229482	43	282814H	119	3228H	96	392735H	74	430644	127
229483	43	282815H	119	323227H	32	392736H	74	430645	124
229659	180	282817H	119	323228H	32	392738H	74	430646	124

Artikelnummernübersicht · Aperçu des numéros d'articles · Article overview

Art.	Seite page	Art.	Seite page	Art.	Seite page	Art.	Seite page	Art.	Seite page
430647	124	430841H	34	430899	193	432142H	81	434500	142
430648	124	430842H	35	430900	192	432143H	81	434501	142
430649	124	430843H	35	43100H	92	432144H	81	434506	142
430650	124	430844H	35	43101H	92	43225H	93	434507	142
430651	124	430845H	35	431913	69	43226H	93	434508	142
430652	124	430846H	36	431914	69	432315H	207	434509	142
430653	124	430847H	36	431915	69	432316H	207	434579	172
430654	124	430848H	36	431916	69	432317H	207	434580	172
430655	125	430849H	36	431917	69	432318H	207	434581	172
430656	125	430850H	36	431918	69	432319H	207	434582	172
430657	125	430851H	36	431919H	70	432320H	207	434583	171
430658	125	430853	194	431920	70	432321H	207	434584	171
430659	125	430854	194	431921	70	432322H	207	434585	171
430660	126	430855	194	431922	70	432323	208	434586	171
430661	126	430856	194	431930	113	432324	208	434587	171
430662	126	430857	188	431931	113	432325	208	434588	171
430663	126	430858	188	431932	113	432326	208	434589	171
430664	126	430859	188	431933	113	432327H	209	434590	171
430665	129	430860	188	431934	113	432328H	209	434591	173
430666	129	430861	188	431935	113	432329H	209	434592	173
430667	129	430862	188	431936	113	432330H	209	434593	173
430668	129	430863	188	431937	113	432331H	209	434594	173
430669	129	430864	188	431938	114	432332H	209	434595	174
430670	130	430865	189	431939	114	432333H	209	434596	174
430671	130	430866	189	431940	114	432334H	209	434597	174
430672	131	430867	189	431941	114	432335H	210	434598	174
430673	131	430868	189	431942	114	432336H	210	434599	173
430674	131	430869	189	431943	114	432337H	210	434600	173
430675	131	430870	189	431944	114	432338H	210	434601	173
430676	131	430871	189	431945	114	433101	180	434602	173
430677	131	430872	189	431946	111	433102	180	434660	136
430678	131	430873	189	431947	111	433109	180	434661	136
430679	131	430874	189	431948	111	433110	180	434662	136
430680	131	430875	189	431949	111	433651	165	434669	137
430681	131	430876	189	431950H	115	433652	165	434670	137
430685	228	430877	190	431951H	115	433658	165	434671	137
430686	228	430878	190	431952H	115	433659	165	434672	137
430687	228	430879	190	431953H	115	433692	51	434673	137
430688	228	430880	190	43200H	92	433693	51	434674	137
430689	228	430881	191	43201H	92	433694	51	434757	51
430690	228	430882	191	432086H	216	433695	53	434758	51
430691	228	430883	191	432087H	216	433696	53	434759	51
430692	228	430884	191	432088H	216	433697	53	434801	28
430693	228	430885	191	432089H	216	433737	52	434802	28
430694	228	430886	191	432090H	216	433738	52	434803	28
430695	229	430887	191	432091H	216	433739	52	434804	28
430696	229	430888	191	432092H	217	433756	53	434805	28
430697	229	430888	192	432093H	217	433757	53	434816	24
430698	229	430889	192	432094H	217	433758	53	434817	24
430699	229	430889	193	432095H	217	434478	141	434818	24
430797H	36	430890	193	432096H	217	434479	141	434819	24
430798H	36	430891	193	432097H	217	434480	141	434820	24
430834H	34	430892	193	432135H	80	434481	141	434821	25
430835H	34	430893	193	432136H	80	434490	141	434822	25
430836H	34	430894	193	432137H	80	434491	141	434823	25
430837H	34	430895	193	432138H	80	434492	141	434824	25
430838H	34	430896	193	432139H	80	434493	141	434825	25
430839H	34	430897	192	432140H	81	434498	142	434826	28
430840H	34	430898	192	432141H	81	434499	142	434827	28

Artikelnummernübersicht · Aperçu des numéros d'articles · Article overview

Art.	Seite page	Art.	Seite page	Art.	Seite page	Art.	Seite page
434828	28	434862	199	44425H	88	8471-B670HK	160
434829	28	434863	199	44447H	89	8471-B690HK	158
434830	28	434864	199	44448H	89	8471-B695HK	158
434831	25	434865	199	44449H	89	8471-B698HK	161
434832	25	434866	199	531910-148	40	8472-B610HK	161
434833	25	434867	199	531911-148	40	8472-B620HK	159
434834	25	434868	199	532212-800	40	8472-B629HK	160
434835	25	434869	199	532230-800	40	8472-B660HK	159
434850	200	434895	26	533434-198	44	8472-B670HK	160
434851	200	434896	26	533436-198	44	8472-B690HK	158
434852	200	434897	26	538020-400	41	8472-B695HK	158
434853	200	434983H	27	538021-400	41	8472-B698HK	161
434854	198	434984H	27	538260-400	41		
434855	198	434985H	27	538261-400	41		
434856	198	434986H	210	538280-400	41		
434857	198	434987H	210	538281-400	41		
434858	198	434988H	210	8471-B610HK	161		
434859	198	434989H	210	8471-B620HK	159		
434860	198	44400H	87	8471-B629HK	160		
434861	198	44401H	87	8471-B660HK	159		

Formatübersicht · Formats · Index according to models

Format Format Model	Seite page page	Format Format Model	Seite page page	Format Format Model	Seite page page	Format Format Model	Seite page page
1 x 20 cm		7,5 x 30 cm		30 x 44,5 cm		Kiano.....	113
Basis 1	44	Lunar.....	135	Like	128	Like	124, 129
2,5 x 2,5 cm		8 x 60 cm		30 x 45 cm		Solid Rock.....	189, 191
Jasba-PATTERN.....	84	Concrete	62	Basis 1	43	Soul.....	198
Jasba-RONDA.....	92	8,45 x 33 cm		30 x 60 cm		Stories.....	207, 210
Jasba-SENJA PURE.....	96, 97	Mando.....	146	Alcina	22, 24	Timeless.....	216
3,7 x 40 cm		10 x 10 cm		Aruba	32, 33, 34, 36	Urban Cotto	224
La Casa.....	121	Jasba-CLARA	80	Basis 1	43	60 x 120 cm	
3,7 x 60 cm		Jasba-PATTERN.....	85	Cedra	48, 51	Aruba	35
La Casa.....	121	10 x 25 cm		Como	56	Oak	160
4 x 60 cm		Kiano.....	112	Concrete	60, 61	Solid Rock.....	190, 191
Como	57	10 x 60 cm		Evalia.....	66, 67	Timeless.....	217
Mandalay.....	140	Cedra	49	Focus Royal	74	80 x 80 cm	
4,5 x 20 cm		Modern White.....	153	Jasba-SENJA PURE.....	99	Like	125
Basis 1	44	Solid Rock.....	188	Kiano.....	110, 113, 114	90 x 90 cm	
4,7 x 30 cm		10 x 90 cm		La Casa.....	119, 120	Alcina	26
Trevi.....	220	Cedra	50	Like	124, 131	100 x 100 cm	
5 x 5 cm		Modern White.....	153	Lunar.....	134, 136	Stories.....	208
Alcina	28	Sky.....	185	Mandalay.....	140, 141	120 x 120 cm	
Cedra	53	15 x 15 cm		Modern White.....	152, 154	Like	126, 130
Evalia.....	70	Basis 1	40	Pizarro.....	164, 165		
Jasba-PATTERN.....	84	Jasba-CLARA	81	Sierra.....	178, 179		
Jasba-RONDA.....	92, 93	15 x 60 cm		Solid Rock.....	189, 193		
Jasba-SENJA PURE.....	98	Mandalay.....	141	Soul.....	198, 199		
Jasba-VILLAGE	102, 103	Pizarro.....	164	Stories.....	204, 205, 207, 209		
Kiano.....	112, 115	Solid Rock.....	189, 192	Timeless.....	214, 216		
Like	127	15 x 90 cm		Trevi.....	220		
Lunar.....	137	Oak	158	30 x 90 cm			
Mandalay.....	142	Remix	170, 171	Alcina	22		
Remix	174	20 x 20 cm		Aruba	32, 33		
Sierra.....	180	Basis 1	40	Basis 1	44		
Solid Rock.....	194	Jasba-PATTERN.....	86, 87, 88, 89	Cedra	48		
Soul.....	200	20 x 25 cm		Evalia.....	66, 67		
Stories.....	210	Basis 1	41	Focus Royal	74, 76		
5 x 60 cm		20 x 40 cm		Jasba-SENJA PURE.....	99		
Solid Rock.....	188	Basis 1	41	Lunar.....	134		
5 x 90 cm		La Casa.....	118	Modern White.....	152, 155		
Sky.....	185	20 x 60 cm		Oak	158		
6 x 60 cm		Basis 1	41	Remix	168, 169, 173		
Oak	161	Jasba-SENJA PURE.....	99	Sky.....	184		
Walden.....	228	La Casa.....	118	30 x 120 cm			
7 x 60 cm		20 x 120 cm		Oak	159, 160		
Alcina	28	Walden	228	35 x 100 cm			
Aruba	36	22,5 x 90 cm		Basis 1	44		
Cedra	53	Remix	171	Kiano.....	110		
Evalia.....	70	24,3 x 43,8 cm		Mando.....	146, 147, 148		
Kiano.....	114	Alcina	23	Stories.....	204, 205		
Like	131	25 x 33 cm		40 x 120 cm			
Lunar.....	137	Basis 1	42	Oak	159		
Mandalay.....	142	25 x 44 cm		Walden.....	229		
Sierra.....	179	Basis 1	42	45 x 90 cm			
Solid Rock.....	193	30 x 30 cm		Alcina	25		
Soul.....	199	Focus Royal	75	Cedra	52		
Stories.....	209	Kiano.....	111	Evalia.....	69		
Timeless.....	217	La Casa.....	121	Remix	172		
Urban Cotto	225	Sierra.....	180	60 x 60 cm			
7 x 90 cm		Stories.....	206	Alcina	25, 27		
Remix	173	Timeless.....	215	Aruba	34		
7,5 x 25 cm		30 x 35 cm		Cedra	51		
Aruba	33	Oak	161	Evalia.....	69		

Sales – Area Managers

(status: November 2021)



RESIDENTIAL CERAMICS GERMANY

Sales territory	Postal code area	Area Manager	E-mail	mobile
0020	17 (ohne 17192 bis 17291, 17326, 17335 bis 17337), 18, 19 (ohne 19309, 19322, 19336, 19348, 19357), 20, 21 (ohne 21244 bis 21272, 21614 bis 21799), 22, 23, 24, 25	Steffen Jantzen	Steffen.Jantzen@deutsche-steinzeug.de	0171/9967208
0021	21244 bis 21272, 21614 bis 21799, 26, 27, 28, 29 (ohne 29410 bis 29416), 31582, 31592, 31595, 31600 bis 31638	Michael Weber	Michael.Weber@deutsche-steinzeug.de	0170/9241872
0022	45600 bis 45799, 46325, 46348, 46359, 46395 bis 46399, 46414, 46419, 46459, 46487, 46499, 48 (ohne 48155 und 48529), 49, 59330 bis 59399	Dominik Gellenbeck	Dominik.Gellenbeck@deutsche-steinzeug.de	0160/96310615
0023	06, 19309 bis 19357, 29410 bis 29416, 38835 bis 38899, 39, 99706 bis 99768	Thomas Bischoff	Thomas.Bischoff@deutsche-steinzeug.de	0151/11012473
0024	30, 31 (ohne 31582, 31592, 31595, 31600 bis 31638), 37154 bis 37199, 37412 bis 37431, 37441 bis 37649, 38 (ohne 38835 bis 38899)	Michael Weber	Michael.Weber@deutsche-steinzeug.de	0170/9241872
0025	32, 33, 44 (ohne 44629), 57 (ohne 57520, 57567, 57583, 57627, 57629, 57642), 58, 59 (ohne 59330 bis 59399)	Holger Rohse	Holger.Rohse@deutsche-steinzeug.de	0170/6322876
0026	34, 35, 36, 37 (ohne 37154 bis 37199, 37412 bis 37431, 37441 bis 37649), 60, 61, 63, 98527 bis 98639, 99610 bis 99638, 99817 bis 99848, 99947 bis 99998	Andreas Strickrodt	Andreas.Strickrodt@deutsche-steinzeug.de	0171/5402801
0027	40, 41, 42, 45 (ohne 45600 bis 45799), 46 (ohne 46325, 46348, 46359, 46395 bis 46399, 46414, 46419, 46459, 46487, 46499), 47, 50, 51, 52, 53	Michael Andries	Michael.Andries@deutsche-steinzeug.de	0171/8610267
0028	54 (ohne 54290 bis 54296), 55, 56, 57520, 57567, 57583, 57627, 57629, 57642, 64, 65, 66, 67, 68, 69	Bernhard Staffeldt	Bernhard.Staffeldt@deutsche-steinzeug.de	0171/5669991
0029	10, 12, 13, 14, 15, 16, 17192 to 17291, 17326, 17335 to 17337	Thomas Bischoff	Thomas.Bischoff@deutsche-steinzeug.de	0151/11012473
0030	72250 bis 72297, 74 (ohne 74321 bis 74399), 75, 76, 77, 78, 79	Michael Stoll	Michael.Stoll@deutsche-steinzeug.de	0151/14823489
0031	70, 71, 72 (ohne 72250 bis 72297), 73, 74321 bis 74399, 88, 89	Michael Stoll	Michael.Stoll@deutsche-steinzeug.de	0151/14823489
0032	01, 02, 03, 04, 07, 08, 09, 98646 bis 98749, 99084 bis 99518, 99867 bis 99898	Jonas Wünsche	Jonas.Wuensche@deutsche-steinzeug.de	0171/2254226
0033	90, 91, 92, 95, 96, 97	Frank Lohre	Frank.Lohre@deutsche-steinzeug.de	0171/5661429
0035	83000 bis 83599, 84, 93, 94	Florian Nößner	Florian.Noessner@deutsche-steinzeug.de	0170/5629482
0036	80, 81, 82, 83600 bis 83799, 85, 86, 87	Florian Nößner	Florian.Noessner@deutsche-steinzeug.de	0170/5629482

AUSTRIA

Austria, Upper Austria, Styria	Robert Wölfler	Robert.Woelfler@deutsche-steinzeug.de	+43 664/1342659
Vienna, Lower Austria, Burgenland	Silvia Lederer	Silvia.Lederer@deutsche-steinzeug.de	+43 664/3076686
Tyrol, Vorarlberg, Salzburg, Kärnten	Erwin Bauer	Erwin.Bauer@deutsche-steinzeug.de	+43 664/1153558

SWITZERLAND

Deutsche Steinzeug Schweiz AG, Oberstmühle 3, 6370 Stans/NW info@deutsche-steinzeug.ch +4141/6325060

World-wide distribution network (status: November 2021)

Albania

POWATEC-AL sh.p.k.
Tel.: +355 4 2270731
Mobile: +355 69 2033095
E-mail: powatec@albmail.com

Australia

Ceramic Solutions (Aust) Pty Ltd.
Tel.: +61 3 95 45 53 22
E-mail: mail@ceramicsolutions.com.au
Internet: www.ceramicsolutions.com.au

Austria

Dipl. Ing. Silvia Lederer
Mobile: +43 664 30 76 68 6
E-mail: silvia.lederer@
deutsche-steinzeug.de

Erwin Bauer

Mobile: +43 664 115 3558
E-mail: erwin.bauer@
deutsche-steinzeug.de

Bahrain

Patric Kakoschky
Tel.: +49 94 35 3 91-34 47
Mobile: +49 160 7417906
E-mail: patric.kakoschky@
deutsche-steinzeug.de

Baltic States

Nedas Bobinas
Tel.: +370 65 624217
E-mail: buchtal.baltic@gmail.com

Belarus

Andriy Horak
Tel.: +49 94 35 3 91-32 76
Mobile: +49 160 741 26 17
Fax: +49 94 35 3 91-30 32 76
E-mail: a.horak@deutsche-steinzeug.de

Belgium

Johan Vanrompay
Mobile: +32 471 84 44 18
E-mail: johan.vanrompay@
deutsche-steinzeug.de

Bosnia-Herzegovina

Lokar Zastopstva d.o.o.
Tel.: +386 15 61 21 63
E-mail: lokar.zastopstva-ds@siol.net

Brazil

Lorenzo Rimondi
Mobile: +39 335 725 86 17
E-mail: lorenzo.rimondi@
deutsche-steinzeug.de

Bulgaria

Hristo Shterev
Mobile: +359 886 899 589
E-mail: hshsterev@gmail.com

Canada

Eastern Canada
CERAGRES TILE GROUP INC.
E-mail: j.racine@ceragres.ca

Western Canada

V.P. Tile Imports
Tel.: +1 604 594 99 02
E-mail: vptileimports@dccnet.com

China

Jeffrey Lung - AGROB BUCHTAL GmbH
Shanghai Office
Tel.: +86 021 63 81 09 86
E-mail: jeffrey.lung@dsk-asia.com

Jeffrey Lung - AGROB BUCHTAL GmbH
Beijing Office
Tel.: +86 010 58 69 19 01
E-mail: jeffrey.lung@dsk-asia.com

Croatia

Lokar Zastopstva d.o.o.
Tel.: +386 15 61 21 63
E-mail: lokar.zastopstva-ds@siol.net

Cyprus

E.K.A. Ltd.
Tel.: +357 2 5 85 44 44
E-mail: mloizides@ekagroup.com

Czech Republic

Ceram Objekt s.r.o.
www.ceramobjekt.cz
Tel.: +420 2 71 74 17 414
E-mail: gciprianova@ceramobjekt.cz

Denmark

Torben Christensen
Tel.: +45 242 05 14 8
E-mail: buchtal@buchtal.dk

Egypt

Patric Kakoschky
Tel.: +49 94 35/3 91-34 47
Mobile: +49 160 7417906
E-mail: patric.kakoschky@
deutsche-steinzeug.de

Finland

ABL Finland OY
Tel.: +358 9 3 50 87 00
E-mail: abl@abl.fi

France

Christophe Rodriguez
Deutsche Steinzeug France S.A.R.L.
Mobile: +33 6 40 94 34 32
E-mail: buchtal@buchtal.fr
Internet: www.agrob-buchtal.de

Great Britain

Rolf Klebl
Mobile: +49 160 74 28 839
E-mail: rolf.klebl@
deutsche-steinzeug.de

Greece

Emco S.A.
Tel.: +30 210 6 13 83 10
E-mail: ostavri@emco.gr

Hungary

Roland Fekete
Tel.: +36 96 51 70 17
E-mail: feketeroland@buchtal.hu

Iceland

Birgisson ehf
Tel.: +354 5160602
E-mail: egill@birgisson.is
Internet: www.birgisson.is

India

Patric Kakoschky
Tel.: +49 94 35 3 91-34 47
Mobile: +49 160 7417906
E-mail: patric.kakoschky@
deutsche-steinzeug.de

Italy

Luigi Maresca
Tel.: +49 94 35 3 91-34 51
E-mail: luigi.maresca@
deutsche-steinzeug.de

Japan

Rolf Klebl
Tel.: +49 94 35 3 91-33 26
Mobile: +49 160 742 88 39
E-mail: rolf.klebl@
deutsche-steinzeug.de

Kazakhstan

Andriy Horak
Tel.: +49 94 35 3 91-32 76
Mobile: +49 160 741 26 17
Fax: +49 94 35 3 91-30 32 76
E-mail: a.horak@
deutsche-steinzeug.de

Kosovo

Lokar Zastopstva d.o.o.
Tel.: +386 15 61 21 63
E-mail: lokar.zastopstva-ds@siol.net

Kuwait

Patric Kakoschky
Tel.: +49 94 35 3 91-34 47
Mobile: +49 160 7417906
E-mail: patric.kakoschky@
deutsche-steinzeug.de

Lebanon

Patric Kakoschky
Tel.: +49 94 35 3 91-34 47
Mobile: +49 160 7417906
E-mail: patric.kakoschky@
deutsche-steinzeug.de

Luxembourg

Philip Daelemans
Mobile: +32 495 30 33 03
E-mail: philip.daelemans@buchtal.be

Macedonia

Lokar Zastopstva d.o.o.
Tel.: +386 15 61 21 63
E-mail: lokar.zastopstva-ds@siol.net

Moldavia

Sabin Maghiar
Tel.: +40 743 45 29 58
E-mail: sabin.maghiar@
deutsche-steinzeug.ro

Montenegro

Lokar Zastopstva d.o.o.
Tel.: +386 15 61 21 63
E-mail: lokar.zastopstva-ds@siol.net

Namibia

O. Behrens & Co. (PTY) Ltd., Windh.
Tel.: +264 61 23 83 00
E-mail: perstling@obeco.com.na

The Netherlands

Sjef van Steenoven
Mobile: +31 (0)657 286829
E-mail: sjef.van-steenoven@
deutsche-steinzeug.nl

Norway

Stein M. Skogstad
Tel.: +47 66 77 94 98
Mobile: +47 91 39 52 08
E-mail: stein@agrob-buchtal.no

Poland

Rafal Butkiewicz
Tel.: +48 6 01 70 67 57
E-mail: biuro@agrob-buchtal.pl

Portugal

Lusomatec
Tel.: +351 915828266
E-mail: nuno.conceicao@
lusomatec.pt
Internet: www.lusomatec.pt

Qatar

Patric Kakoschky
Tel.: +49 94 35 3 91-34 47
Mobile: +49 160 7417906
E-mail: patric.kakoschky@
deutsche-steinzeug.de

Romania

Sabin Maghiar
Tel.: +40 743 45 29 58
E-mail: sabin.maghiar@
deutsche-steinzeug.ro

Russia

Andriy Horak
Tel.: +49 94 35 3 91-32 76
Mobile: +49 160 741 26 17
Fax: +49 94 35 3 91-30 32 76
E-mail: a.horak@deutsche-steinzeug.de

Saudi Arabia

Patric Kakoschky
Tel.: +49 94 35 3 91-34 47
Mobile: +49 160 7417906
E-mail: patric.kakoschky@
deutsche-steinzeug.de

Serbia

Lokar Zastopstva d.o.o.
Tel.: +386 15 61 21 63
E-mail: lokar.zastopstva-ds@siol.net

Slovakia

BUCHTAL SK, s.r.o.
Tel.: +421 2 44 25 03 69
E-mail: b.hauswald@agrob.buchtal.sk
Internet: www.agrob.buchtal.sk

Slovenia

Lokar Zastopstva d.o.o.
Tel.: +386 15 61 21 63
E-mail: lokar.zastopstva-ds@siol.net

South Africa (RSA)

Roger Skudder
Tel.: +27 16 362 16 17
E-mail: rskudder@global.co.za

Spain

Joaquín Prat Pérez-Nievas
Mobile: +34 607 923 470
E-mail: joaquin.prat@buchtal.es
Internet: www.buchtal.es

Sweden

Stein M. Skogstad
Tel.: +47 66 77 94 98
Mobile: +47 91 39 52 08
E-mail: stein@agrob-buchtal.no

Switzerland

Deutsche Steinzeug Schweiz AG
Tel.: +41 41 6 32 50 60
E-mail: info@deutsche-steinzeug.ch

Turkey

Patric Kakoschky
Tel.: +49 94 35 3 91-34 47
Mobile: +49 160 7417906
E-mail: patric.kakoschky@
deutsche-steinzeug.de

UAE

Patric Kakoschky
Tel.: +49 94 35 3 91-34 47
Mobile: +49 160 7417906
E-mail: patric.kakoschky@
deutsche-steinzeug.de

Ukraine

Andriy Horak
Tel.: +49 94 35 3 91-32 76
Mobile: +49 160 741 26 17
Fax: +49 94 35 3 91-30 32 76
E-mail: a.horak@deutsche-steinzeug.de

Sales management

Austria

Robert Wöfler
Tel.: +43 664 1342659
E-mail: robert.woelfler@
deutsche-steinzeug.de

Belgium, The Netherlands, Luxembourg

Richard van der Maaten
Mobile: +31 (0)621 478134
E-mail: richard.van-der-maaten@
deutsche-steinzeug.de

Eastern Europe

Markus Pavelic
Tel.: +49 94 35 3 91-3463
Mobile: +49 171 56 74 713

France, Spain, Portugal, Monaco, Andorra

Christophe Rodriguez
Mobile: +33 640 94 34 32
E-mail: christophe.rodriguez@
deutsche-steinzeug.de

Korea, Taiwan, Hong Kong, Thailand, China, Japan, Singapore, Indonesia, The Philippines, Malaysia, Brunei, Vietnam, Myanmar, Laos, Cambodia

Jeffrey Lung
Mobile: +852 51 67 36 66
E-mail: jeffrey.lung@dsk-asia.com

Middle East, Iraq, Iran, India, Greece, Cyprus, Turkey, Australia / New Zealand, Africa

Patric Kakoschky
Tel.: +49 94 35 3 91-34 47
Mobile: +49 160 741 79 06
E-mail: patric.kakoschky@
deutsche-steinzeug.de

Northern Europe, Baltic States, Canada, Great Britain, Ireland

Rolf Klebl
Tel.: +49 94 35 3 91-33 26
Mobile: +49 160 742 88 39
E-mail: rolf.klebl@deutsche-steinzeug.de

Italy

Virginio Quirci
Mobile: +39 (335) 5360808
E-mail: virginio.quirci@deutsche-steinzeug.de

Ukraine, Russia and Belarus

Andriy Horak
Tel.: +49 94 35 3 91-32 76
Mobile: +49 160 741 26 17
Fax: +49 94 35 3 91-30 32 76
E-mail: a.horak@deutsche-steinzeug.de

Switzerland

Deutsche Steinzeug Schweiz AG
Renato Borsani
Tel.: +41 41 632 50 60
E-mail: renato.borsani@
deutsche-steinzeug.ch

USA

DSA Deutsche Steinzeug
America, Inc.
Tel.: +1 770 442 55
Fax: +1 770 442 55
Udo Reich
E-mail: udo.reich@agrob-buchtal.com
E-mail: udo.reich@drytilenorthamerica.com
E-mail: info@agrob-buchtal.com
Internet: www.agrob-buchtal.com

Latin America

Diego Chavez
Tel.: +591 76 34 04 22
E-mail: diego@buchtal.latam.com
Internet: www.gclatinamerica.com



Hier finden Sie unsere technischen Informationen:
Vous trouverez ici nos Informations Techniques :
There you will find our Technical Information:



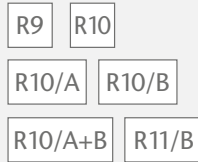

Diese Fliesen verfügen über die entsprechende Trittsicherheitsklasse.
 Ces carreaux disposent des classes d'antidérapance correspondantes.
 These tiles have the respective slip-resistance class.



Diese Fliese verfügt über Hytect.
 Ce carreau dispose de la finition Hytect.
 This tile is provided with Hytect.



Diese Fliese verfügt über eine Protecta-Vergütung.
 Ce carreau dispose d'une finition Protecta.
 This tile is Protecta-coated.



Diese Fliese ist rektifiziert, d. h. sie ist mit einer besonders engen Fuge verlegbar.
 Ce carreau est rectifié et peut être posé avec un joint particulièrement fin.
 This tile is rectified, i. e. it can be laid with particularly narrow joints.



Nicht oder nur bedingt säure- und laugenbeständig
 Pas de résistance aux acides et aux bases ou résistance limitée
 Not or only limited acid and alkali resistant



Rektifizierte Wandfliesen mit gerundeten, geschliffenen Kanten: keine scharfkantigen Übergänge / Ränder, Unregelmäßigkeiten des Untergrunds können optisch einfacher ausgeglichen werden, eine sehr enge Verlegung der Fliese ist möglich (1-2 mm Fuge)
 Carreaux de mur rectifiés à bords arrondis, biseautés : pas de raccords / de rebords à angles vifs, les inégalités du support peuvent être compensées optiquement avec plus de facilité, une pose des carreaux à joint très serré (1 à 2 mm) est possible
 Rectified wall tiles with rounded, bevelled edges: no sharp-edged transitions/edges, irregularities displayed by the base can be easily compensated for, tiles can be laid very close together (1-2 mm joints)



Thermoplastisch verklebte Mosaik sind bedenkenlos im Unterwasserbereich (z.B. Schwimmbecken/Whirlpool) sowie im dauernassbelasteten Bereich (z.B. Beckenumgang/Duschen) einsetzbar.
 Les mosaïques fixées au moyen de collage thermoplastique peuvent être utilisées sans crainte pour la pose au-dessous du niveau de l'eau (p. ex. piscines / whirlpools) ainsi que dans les zones constamment humides (p. ex. plages de piscines/douches).
 Thermoplastically glued mosaics can be used without any problems in underwater areas (e.g. swimming pools/whirlpools) as well as in permanently wet areas (e.g. pool surrounds/showers).



Diese Fliese ist frostsicher.
 Ce carreau est ingélf.
 This tile is frost-proof.



6 mm Fliese
 Carreau de 6 mm
 6 mm tile

Color Shade Variation

„Color shade variation“ beschreibt die farbliche Änderung zwischen den Fliesen einer Farbstellung, d.h. den Abtönungsgrad. Die Einstufung unserer Produkte erfolgt in 4 Abtönungskoeffizienten.

Color Shade Variation

« Color shade variation » décrit les variations de teintes entre les carreaux d'une même couleur, c'est à dire le dégradé visible. Nos produits sont classés en 4 coefficients de dégradés.

Color Shade Variation

“Color shade variation” refers to the variations in color between the tiles of a certain color, i.e. the degree of shading. Our products are classified into 4 shading coefficients.

- V1 Geringe Variation / geringes Farbspiel
 Variation faible / Jeu de couleurs peu prononcé
 Low variation / Low play of colors
- V2 Mittlere Variation / mittleres Farbspiel
 Variation moyenne / Jeu de couleurs moyen
 Medium variation / Medium play of colors
- V3 Hohe Variation / hohes Farbspiel
 Variation élevée / Jeu de couleurs important
 High variation / High play of colors
- V4 Starke Variation / starkes Farbspiel
 Variation forte / Jeu de couleurs intense
 Strong variation / Strong play of colors

AGROB BUCHTAL GmbH
Buchtal 1, D-92521 Schwarzenfeld
Tel.: +49 (0) 94 35-391-0
Fax: +49 (0) 94 35-391-34 52

E-Mail: agrob-buchtal@deutsche-steinzeug.de
Internet: www.agrob-buchtal.de



Der Herausgeber übernimmt keine Haftung für Druckfehler. Farbabweichungen zu den Originalprodukten können aus drucktechnischen Gründen auftreten.
L'éditeur décline toute responsabilité en cas d'erreurs d'impression. Des écarts de couleur par rapport aux produits originaux peuvent apparaître pour des raisons liées aux techniques d'impression.
The publisher assumes no liability for typographical errors. Color deviations from the original products may occur during the printing process.

printed 01/2022, www.assenmacher.net